

# Window Replacement Hardware

Call us at 800-992-4282 for pricing.

Returns incur a 25% restocking fee.

Orders under \$25 incur a \$5 small order handling fee.

## Sliding Window Rollers with Metal Housing

Sliding window rollers in order by roller diameter, length and width.

5/16"

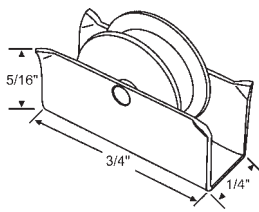

**900-1276**  
5/16" Dia. Nylon Wheel

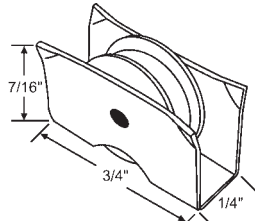

**900-8374**  
5/16" Dia. Nylon Wheel

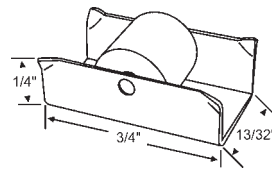

**52-615**  
5/16" Dia. Nylon Wheel

11/32"

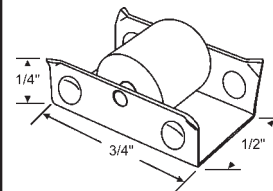

**900-1278**  
11/32" Dia. x 3/8" Nylon Wheel

3/8"

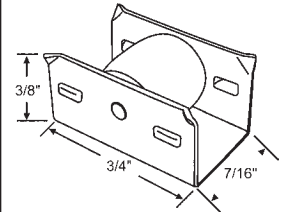

**52-616**  
3/8" Dia. Nylon Wheel

29/64"

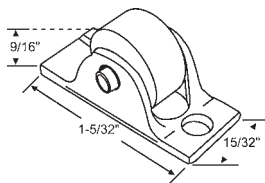

**900-10027**  
29/64" Dia. Nylon Wheel with Die Cast Housing

15/32"

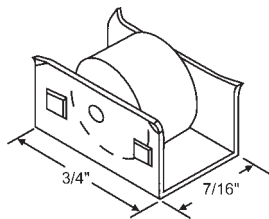

**900-1285**  
15/32" Dia. Flat Nylon Wheel

1/2"

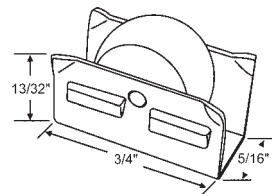

**52-614**  
1/2" Dia. Nylon Wheel

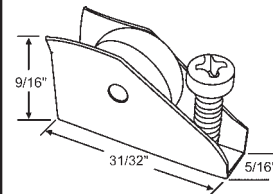

**52-683**  
1/2" Dia. Nylon Wheel  
**Capitol**

9/16"

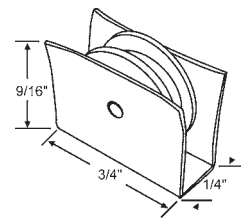

**52-613**  
9/16" Nylon Wheel

## Sliding Window Rollers with Plastic Housing

5/8"

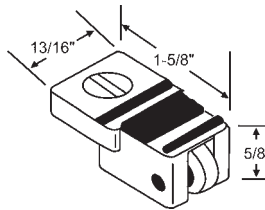

**52-682**  
9/16" Dia. Metal Wheel with Die Cast Housing. Used with Plate 900-16252

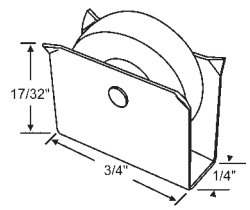

**900-1290**  
5/8" Dia. Flat Nylon Wheel

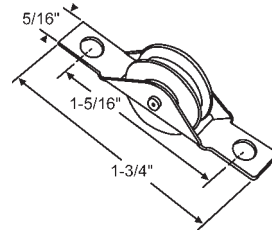

**52-650**  
5/8" Dia. Nylon Wheel

9/32"

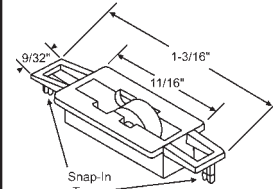

**52-766**  
9/32" Dia. Metal Wheel

5/16"

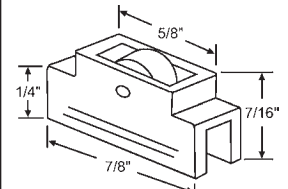

**52-643**  
5/16" Dia. Metal Roller

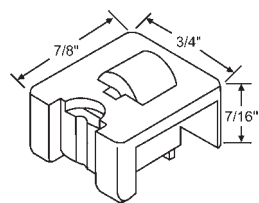

**900-11416**  
5/16" Dia. Metal Wheel w/Fixed Axle

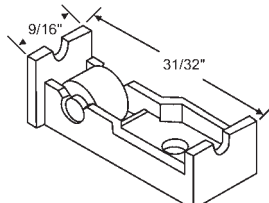

**900-14615**  
5/16" Dia. Flat Nylon Wheel w/ Fixed Axle

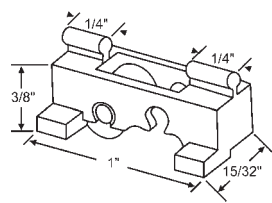

**900-22**  
5/16" Dia. Flat Metal Wheel w/Fixed Axle

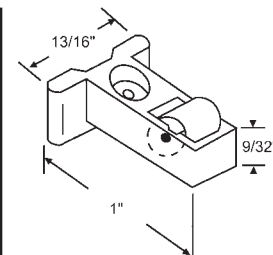

**52-638**  
5/16" Dia. Metal Wheel

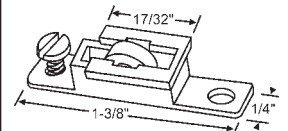

**52-856**  
5/16" Dia. Flat Nylon Wheel White  
**Acorn**

# Window Replacement Hardware

## Sliding Window Rollers with Plastic Housing

5/16"

3/8"

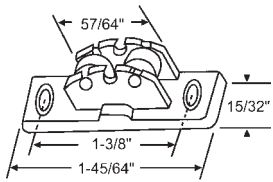

**900-10193**

Two 5/16" Dia. Metal Wheels  
**General Aluminum**

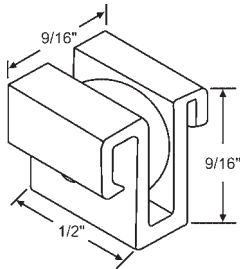

**52-646**

3/8" Dia. Plastic Wheel

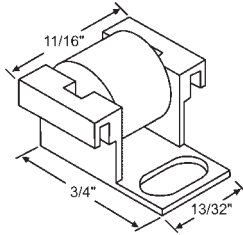

**900-18313**

3/8" Dia. Metal Wheel

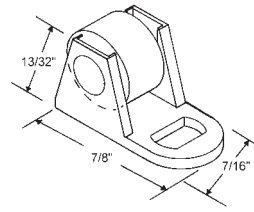

**52-721**

3/8" Dia. Nylon Wheel  
w/Fixed Axle

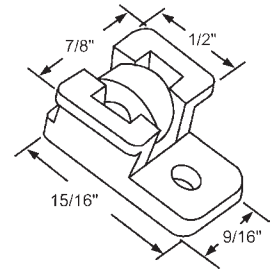

**900-18013**

3/8" Dia. Flat Metal Wheel  
w/Fixed Axle

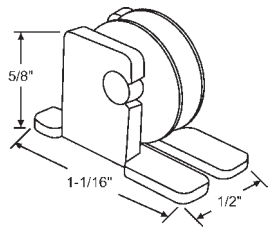

**52-644**

3/8" Dia. Metal Wheel  
**Fullview**

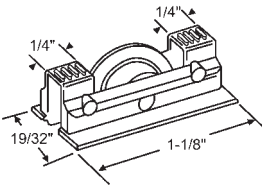

**900-10784**

3/8" Dia. Nylon Wheel with 1/2"  
Dia. Single Side Flange

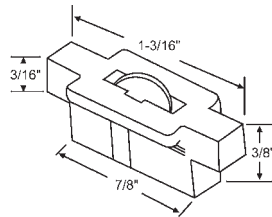

**52-648**

3/8" Dia. Metal Wheel

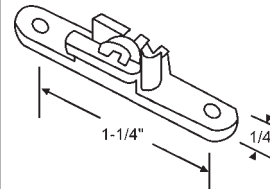

**52-649**

3/8" Dia. Metal Wheel

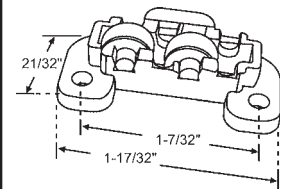

**52-789**

Two 3/8" Dia. Brass Wheels  
Black

3/8"

25/64"

13/32"

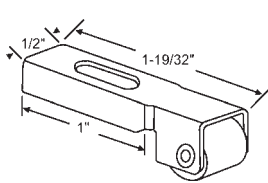

**900-1064**

3/8" Dia. Flat Nylon Wheel

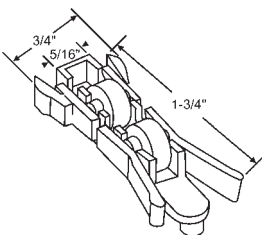

**52-724**

Two 3/8" Dia. Flat Brass Wheels  
w/Separate Axles

**Reynolds**

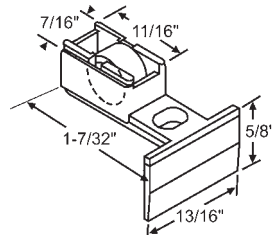

**900-9008**

25/64" Dia. Flat Nylon Wheel  
w/Fixed Axle

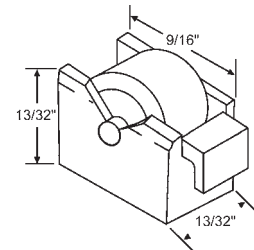

**52-647**

25/64" Dia. Metal Wheel

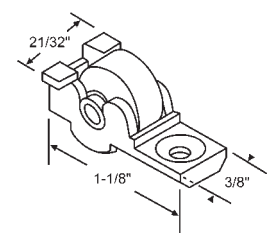

**900-9814**

13/32" Dia. Nylon Wheel

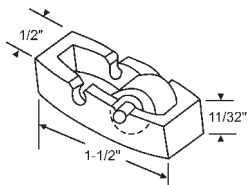

**52-629**

13/32" Dia. Metal Wheel

**Capitol**

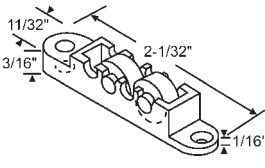

**52-722**

Two 13/32" Dia. Flat Metal  
Wheels w/Separate Axles

**Natural**

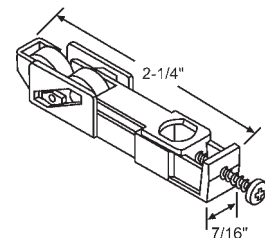

**900-19102**

Two 13/32" Dia. Wheels  
Black

**Rusco**

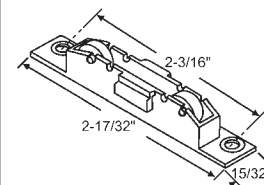

**52-762**

Two 13/32" Dia. Flat Wheels  
w/Fixed Axle

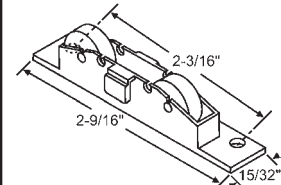

**52-799**

Two 13/32" Dia. Aluminum  
Wheels w/Fixed Axles

# Window Replacement Hardware

## Sliding Window Rollers with Plastic Housing

13/32"

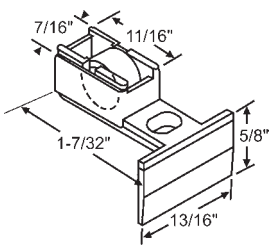

**900-9008M**

13/32" Dia. Flat Metal Wheel w/  
Fixed Axle

7/16"

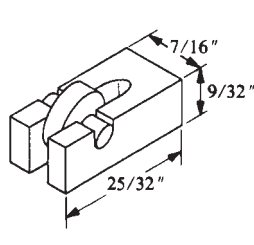

**900-12009**

7/16" Dia. Nylon Wheel

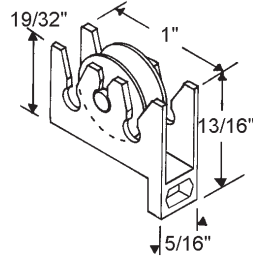

**900-11290**

7/16" Dia. Metal Wheel  
w/Fixed Axle

**Alenco**

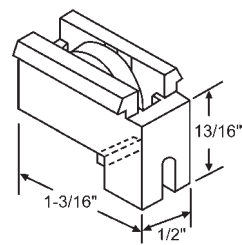

**900-11944NS**

7/16" Dia. Brass Wheel  
Projects 1/8" from Housing

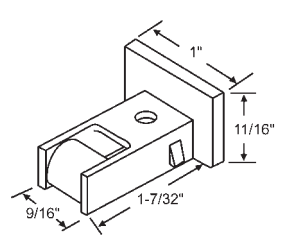

Part #	Description
52-686	Nylon Roller
52-686M	Steel Roller

7/16" Dia. Wheel

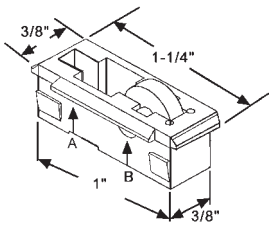

**52-733**

7/16" Dia. Flat Metal Wheel  
w/Separate Axles. Roller Projects 1/8"  
in Position "A" and 1/16" in Position "B".

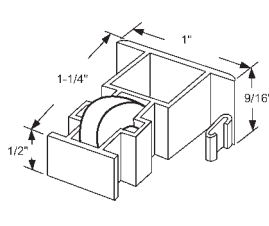

**52-843**

7/16" Dia. Metal Wheel

**Nu-Air**

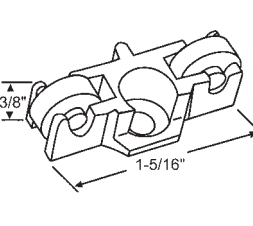

**52-658**

Two 7/16" Dia. Nylon Wheels

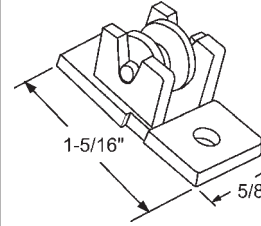

**900-19965**

7/16" Dia. x 5/16" Wide Concave  
Wheel w/Fixed Axle. White

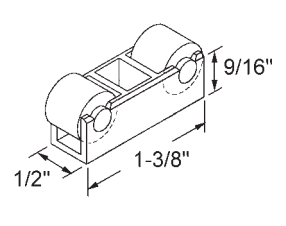

**52-514**

Two 7/16" Dia. Nylon Wheels

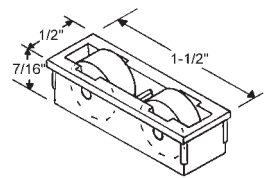

**900-17801**

Two 7/16" Dia. Metal Wheels

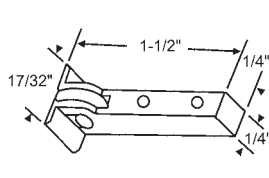

**900-92**

7/16" Dia. Flat Nylon Wheel

**Guaranteed**

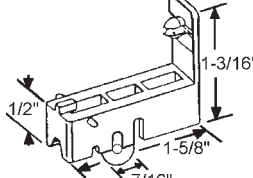

**900-1067**

7/16" Dia. Nylon Wheel

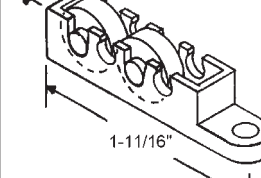

**900-19941**

Two 7/16" Dia. Metal Wheels  
w/Separate Axles

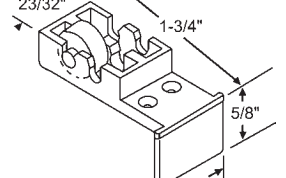

**52-690**

7/16" Dia. Flat Wheel  
w/Fixed Axle

**Capitol**

15/32"

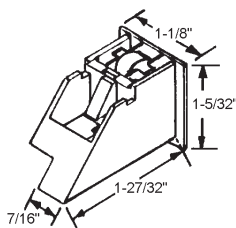

**52-715A**

RH/LH Set, Black  
Two 7/16" Dia. Metal Wheels

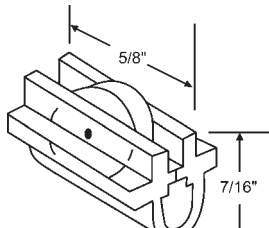

**52-661**

15/32" Dia. Nylon Wheel

**IDA**

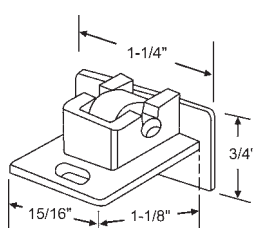

**900-17797**

15/32" Dia. x 1/4" Wide Flat Metal  
Wheel w/Fixed Axle  
Black

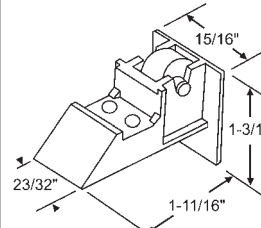

**900-19580A**

15/32" Dia. Flat Metal Wheel  
w/Fixed Axle

**Norandex**

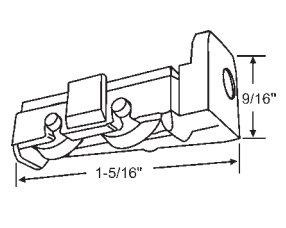

Part #	Hand
900-9391RHA	Shown
900-9391LHA	Opposite

Two 15/32" Dia. Brass Wheel

**Acorn**

# Window Replacement Hardware

## Sliding Window Rollers with Plastic Housing

15/32"

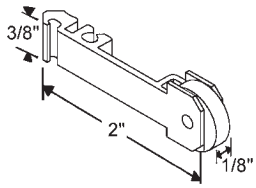

Part #	Description
52-778	Brass Plated Roller
52-778B	Solid Brass Roller

15/32" Dia. Wheel

31/64"

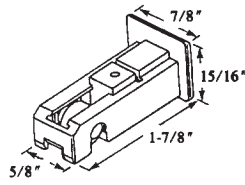

**52-695**

31/64" Dia. Nylon Wheel

1/2"

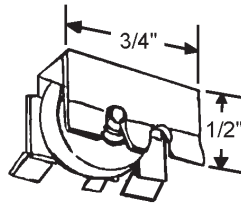

**900-14936**

1/2" Dia. Metal Wheel

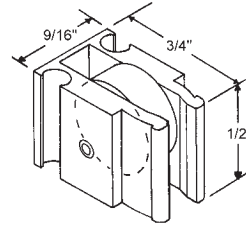

**900-12179**

1/2" Dia. Flat Steel Wheel

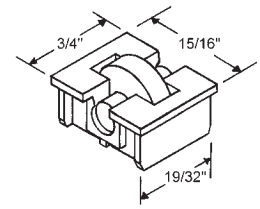

**52-718**

1/2" Dia. Flat Wheel w/Fixed Axle

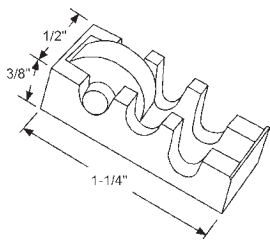

**900-8995**

1/2" Dia. Flat Metal Wheel w/  
Separate Axle

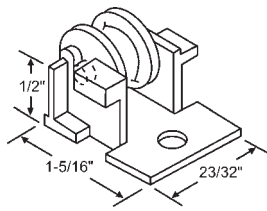

**900-10454**

1/2" Dia. Metal Wheel  
w/Separate Axle

**Krestmark**

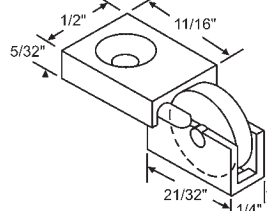

**900-8212**

1/2" Dia. Flat Nylon Wheel  
w/Fixed Axle

**Keller/Acorn**

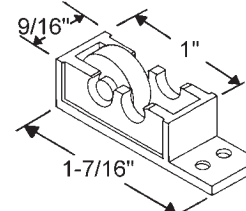

**52-712**

1/2" Dia. Flat Metal Wheel  
w/Fixed Axle

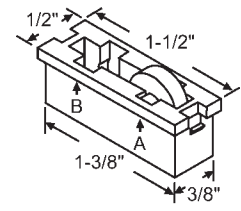

**52-859**

1/2" Dia. Flat Metal Wheel  
Roller Projects 3/32" in Position  
"A" and 5/32" in Position "B".

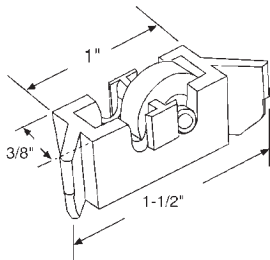

**900-12857**

1/2" Dia. Brass Wheel  
w/Separate Axle

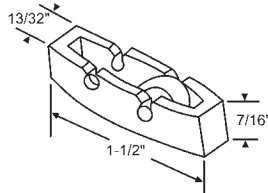

**52-632**

1/2" Dia. Stainless Steel  
Wheel and Axle

**Capitol**

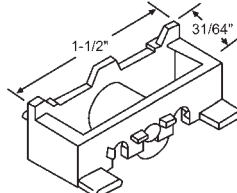

**52-684**

1/2" Dia. Nylon Wheel

**Chamberlain**

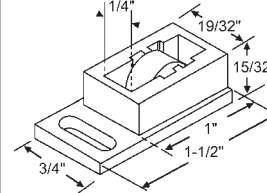

Part #	Description
900-1293	Flat Metal Roller
900-1293A	Brass Roller

1/2" Dia. Wheel

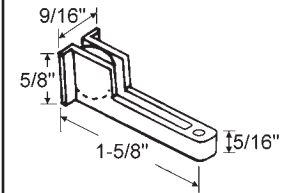

**52-790**

1/2" Dia. Flat Nylon Wheel

33/64"

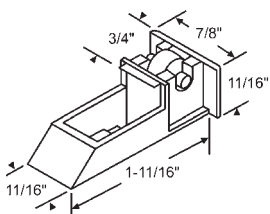

**900-16704**

1/2" Dia. Flat Metal Wheel  
Black

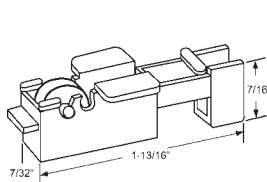

**52-807**

1/2" Dia. Wheel  
**Acorn**

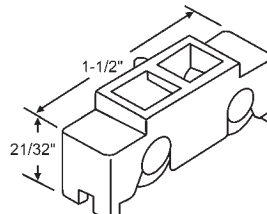

**52-689**

Two 33/64" Dia. Nylon Wheels

**Gallatin**

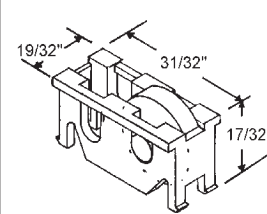

**900-8996**

17/32" Dia. Metal Wheel

**Sullivan**

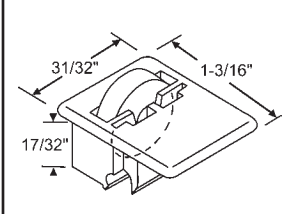

**900-10192**

17/32" Dia. Flat Metal Wheel  
w/Separate Axle

17/32"

# Window Replacement Hardware

## Sliding Window Rollers with Plastic Housing

17/32"

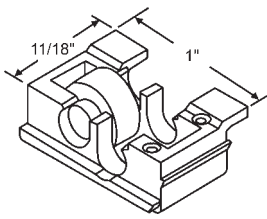

**52-713**  
17/32" Dia. Flat Wheel

**Capitol**

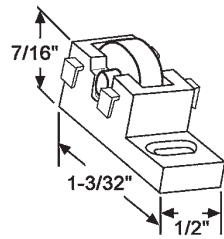

**900-20289**  
17/32" Dia. Flat Metal Wheel w/  
Separate Axle

**Rollyson**

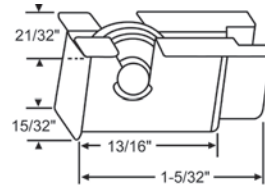

**52-707**  
17/32" Dia. Metal Wheel

**Reynolds**

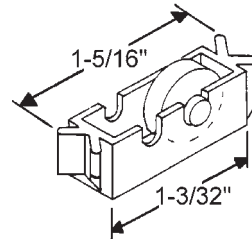

**900-10293**  
17/32" Dia. Flat Metal Wheel  
w/Separate Axle

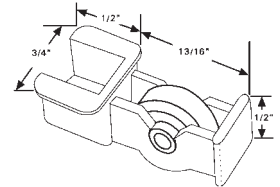

**900-9765**  
17/32" Dia. Flat Ball Bearing  
Wheel w/Fixed Axle

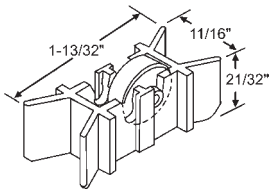

**900-12993**  
17/32" Dia. Wheel

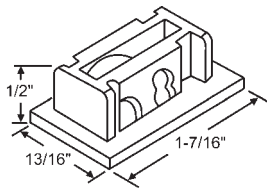

**52-676**  
17/32" Dia. Metal Wheel

**Acorn**

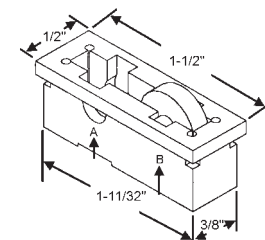

**900-21376**  
17/32" Dia. Metal Wheel with  
Separate Axle. Roller Projects 1/32" in  
Position "A" and 1/8" in Position "B".

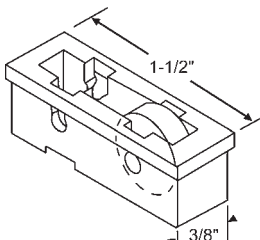

**900-12609**  
17/32" Dia. Wheel  
Roller Projects 1/16" in Position  
"A" and 3/32" in Position "B".

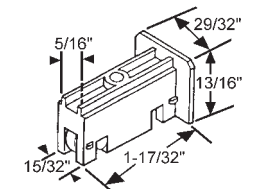

**900-20286**  
17/32" Dia. Flat Ball Bearing  
Wheel w/Fixed Axle

9/16"

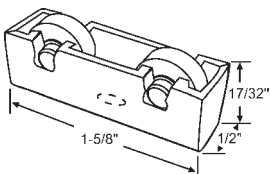

**900-11791**  
Two 17/32" Dia. Metal Wheel

**Keller**

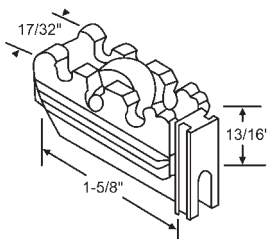

**52-625**  
17/32" Dia. Metal Wheel

**Acorn**

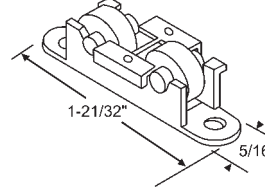

**900-10419**  
Two 17/32" Dia. Nylon Wheels

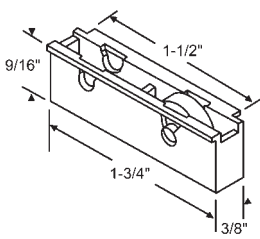

**900-11564**  
17/32" Dia. Metal Wheel

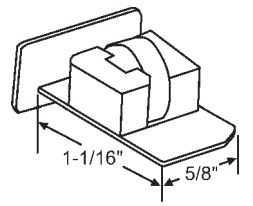

**52-808**  
9/16" Dia. Flat Metal Wheel  
w/Separate Axle

**Capitol**

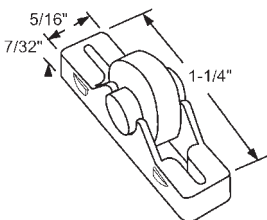

**52-728**  
9/16" Dia. Steel Ball  
Bearing Wheel

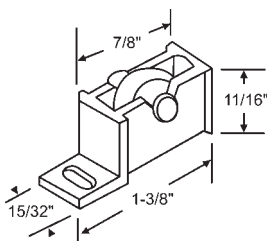

**52-680**  
9/16" Dia. Nylon Wheel

**Capitol**

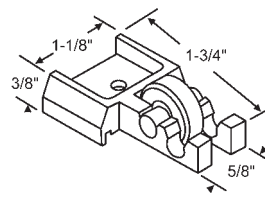

**900-8512A**  
9/16" Dia. Flat Metal Wheel  
w/Separate Axle

**Capitol**

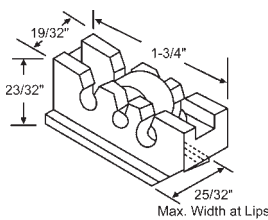

**52-622**  
9/16" Dia. Metal Wheel

**Capitol**

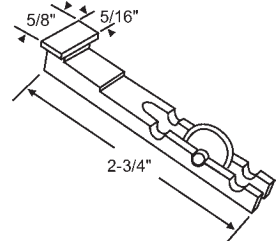

**900-8423**  
9/16" Dia. Nylon Convex Wheel  
w/Fixed Axle

# Window Replacement Hardware

## Sliding Window Rollers with Plastic Housing

9/16"

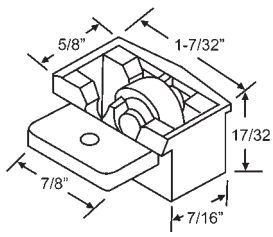

**900-10416**

9/16" Dia. Steel Ball  
Bearing Wheel

19/32"

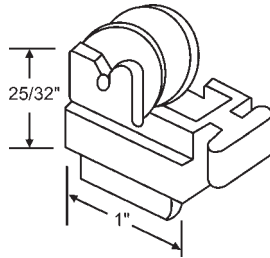

**52-642**

19/32" Dia. Metal Wheel

5/8"

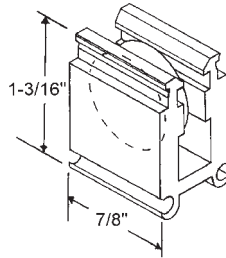

**900-11124**

5/8" Dia. Flat Steel Wheel

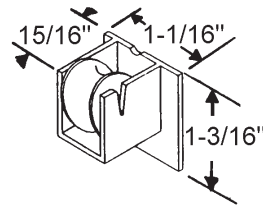

Part #	Hand
52-699LH	Shown
52-699RH	Opposite

5/8" Dia. Metal Wheel  
w/Separate Axle

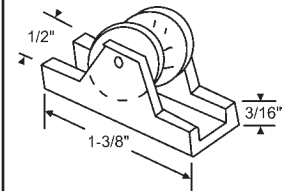

**52-671**

5/8" Dia. Metal Wheel

**Rollyson**

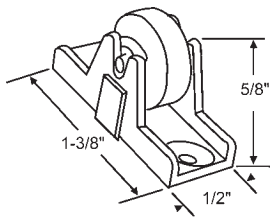

**900-68**

5/8" Dia. Flat Steel Wheel  
w/Separate Axle

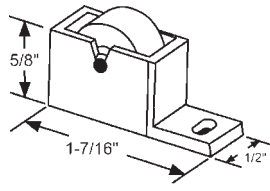

**900-1295**

5/8" Dia. Flat Brass Wheel  
w/Separate Stainless Steel Axle

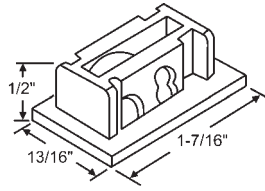

**52-676HD**

5/8" Dia. Ball Bearing  
Metal Wheel

**Acorn**

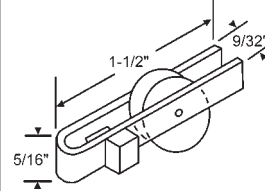

**52-626**

5/8" Dia. Nylon Wheel

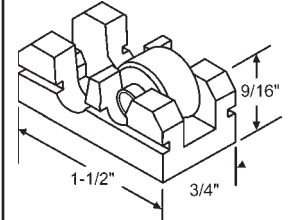

**900-20066A**

5/8" Dia. Metal Wheel

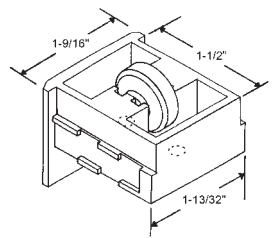

**52-714**

Cam and Roller Assembly  
5/8" Dia. Ball Bearing Wheel

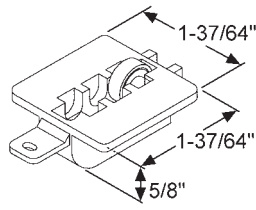

**52-805**

5/8" Dia. Flat Metal Ball Bearing  
Wheel w/Fixed Axles

**Acorn**

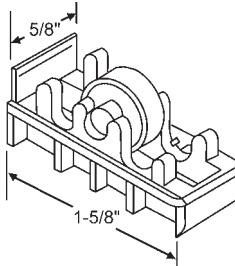

Part #	Color
900-8245A	Black

5/8" Dia. Metal Wheel

**Acorn**

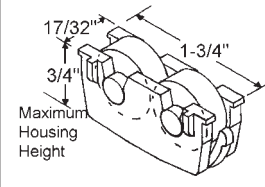

**900-1797A**

Two 5/8" Dia. Metal Wheels  
White

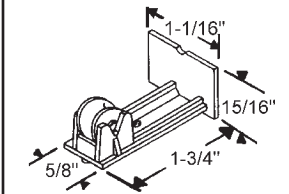

Part #	Hand
52-702	Shown
52-701	Opposite

5/8" Dia. Metal Wheel with  
Separate Axle

**Alsco/Sugarcreek**

21/32"

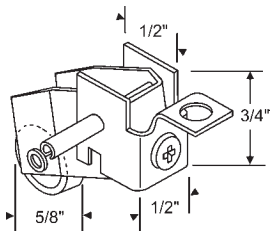

**900-13358**

5/8" Dia. Flat Ball Bearing  
Steel Wheel

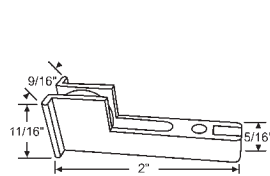

**52-645**

21/32" Dia. Nylon Wheel. No  
Longer Available. Use: 52-790  
See page 110

23/32"

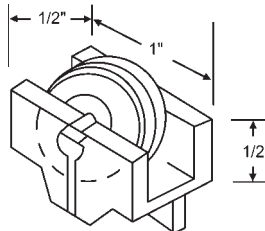

**52-609**

23/32" Dia. Flat Nylon Wheel

**Crossly**

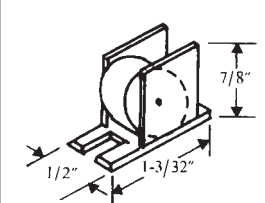

**52-623**

23/32" Dia. Nylon Wheel

3/4"

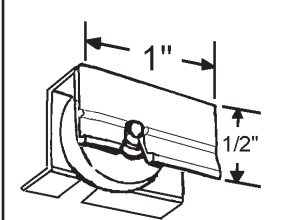

**52-694**

3/4" Dia. Flat Nylon Ball Bearing  
Wheel

**Premiere**

# Window Replacement Hardware

## Sliding Window Rollers with Plastic Housing

3/4"

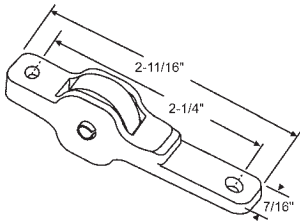

**900-20814**

3/4" Dia. Flat Nylon Wheel

25/32"

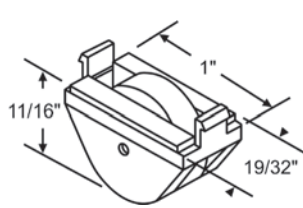

**900-17156**

25/32" Dia. Wheel

13/16"

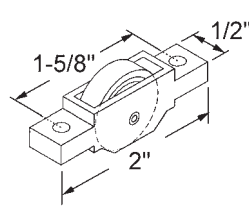

**52-698A**

13/16" Dia. Flat Nylon Ball Bearing Wheel

7/8"

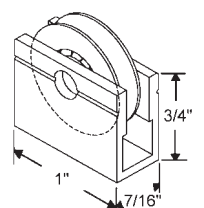

**900-20796A**

7/8" Dia. Steel Ball Bearing Wheel

## Weep Covers

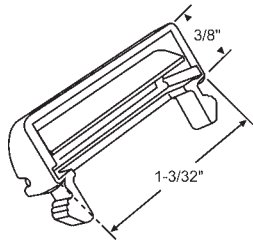

Part #	Color
900-20137	White
900-20137BE	Beige

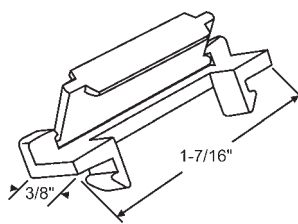

Part #	Color
900-17790W	White
900-17790	Beige

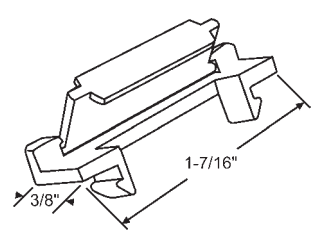

**900-20138**

## Sliding Window Wheels

Roller Diagram

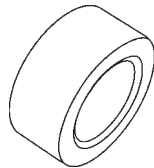
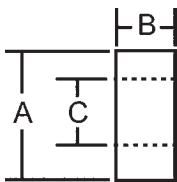

52-693		
A	B	C
7/16"	3/16"	1/4"

Flat Metal

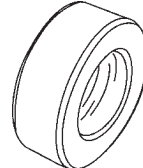

52-619		
A	B	C
1/2"	11/64"	11/64"

Brass Roller

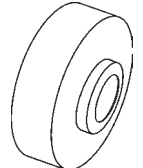

52-683R				
A	B	C	D	E
1/2"	5/32"	1/8"	1/32"	15/64"

Nylon

## Sliding Window Wheels with Fixed Axle



52-634		
A	B	C
17/32"	9/64"	1/8"

Nylon

Roller Diagram

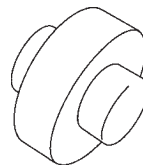
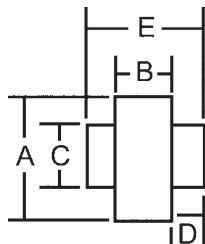

900-8618				
A	B	C	D	E
9/32"	3/32"	5/32"	1/16"	7/32"

Nylon Vent Roller

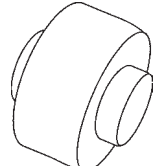

900-10418				
A	B	C	D	E
3/8"	3/16"	3/16"	1/32"	1/16"

Nylon

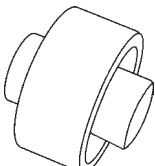

900-9814W			
A	B	C	E
25/64"	3/16"	3/16"	3/8"

Nylon with Offset Axle

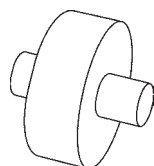

900-2041				
A	B	C	D	E
7/16"	5/32"	1/8"	1/8"	13/32"

Nylon

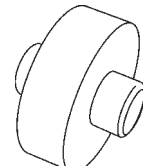

52-631				
A	B	C	D	E
1/2"	11/64"	3/16"	5/32"	25/64"

Stainless Steel

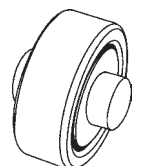

900-9764				
A	B	C	D	E
17/32"	3/16"	3/16"	3/32"	3/8"

Steel with Ball Bearings

# Window Replacement Hardware

## Sliding Window Wheels with Fixed Axle

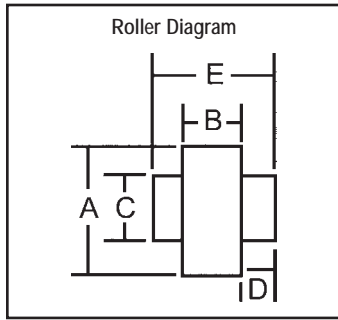
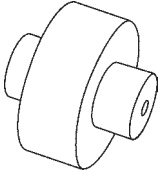
52-679				
A	B	C	D	E
9/16"	1/4"	1/4"	1/8"	1/2"

Nylon Window Roller

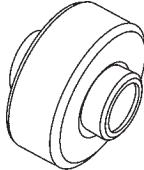

11-147				
A	B	C	D	E
9/16"	7/32"	1/4"	9/64"	7/16"

Steel with Ball Bearings

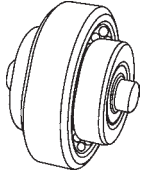

900-15444A				
A	B	E	H	I
5/8"	3/16"	3/8"	1/2"	1/8"

Steel with Ball Bearings

## Sliding Window Wheels with Axle

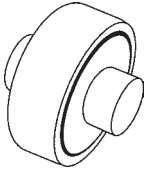

900-9564				
A	B	C	D	E
5/8"	1/4"	1/4"	1/8"	1/2"

Steel with Ball Bearings  
**Acorn**

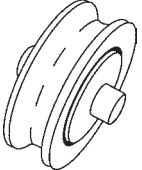

52-703R				
A	B	C	D	E
3/4"	1/4"	5/32"	3/32"	1/2"

Concave Nylon with Steel Hub and Ball Bearings

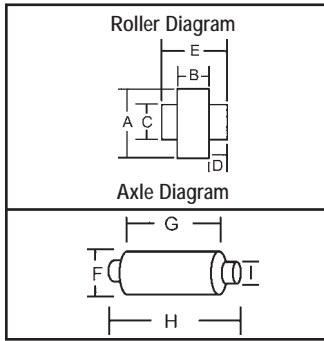
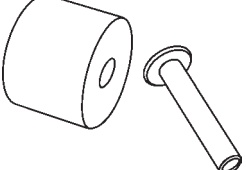
52-653				
A	B	C	H	I
3/8"	9/32"	3/32"	19/32"	3/32"

Nylon with Aluminum Axle

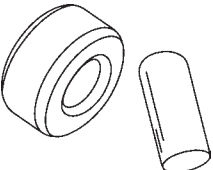

52-628				
A	B	C	F	H
29/64"	7/32"	3/16"	3/16"	1/2"

Steel

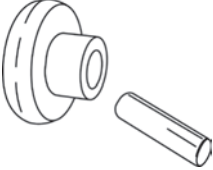

52-610					
A	B	C	D	H	I
1/2"	1/8"	1/8"	5/32"	13/32"	1/64"

Nylon with Steel Axle

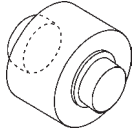

52-688				
F	G	I	D	H
1/2"	9/32"	1/4"	1/16"	27/64"

Nylon

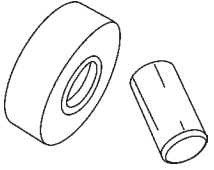

900-11791W				
A	B	C	D	E
17/32"	13/64"	3/16"	3/32"	3/8"

Steel

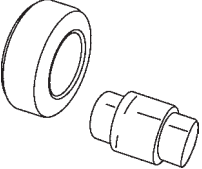

52-621						
A	B	C	F	G	H	I
9/16"	1/4"	5/16"	5/16"	1/4"	1/2"	1/4"

Aluminum with Steel Axle

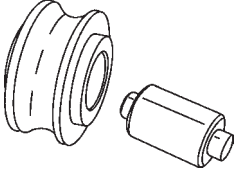

52-700							
A	B	C	E	F	G	H	I
39/64"	17/64"	1/4"	23/64"	1/4"	3/8"	1/2"	1/8"

Concave Metal. Axle Included

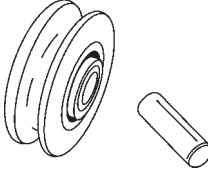

52-651					
A	B	C	E	F	H
5/8"	13/64"	1/8"	1/4"	1/8"	3/8"

Ball Bearing Roller with Axle

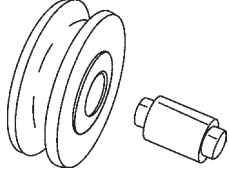

52-652							
A	B	C	E	F	G	H	I
5/8"	7/32"	13/16"	15/64"	3/16"	1/4"	3/8"	1/8"

Nylon Roller with Metal Axle

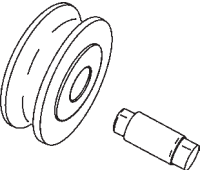

52-703RNEW							
A	B	C	E	F	G	H	I
3/4"	1/4"	3/16"	3/16"	19/64"	5/16"	1/2"	5/32"

Nylon with Brass Axle

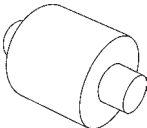

900-11416R				
F	G	I	D	H
5/16"	19/64"	1/8"	3/32"	15/32"

Steel

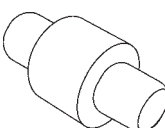

900-8952				
F	G	I	D	H
5/16"	1/4"	13/64"	3/16"	21/32"

Steel

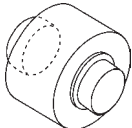

52-688				
F	G	I	D	H
1/2"	9/32"	1/4"	1/16"	27/64"

Nylon



# Window Replacement Hardware

## Slider Guides

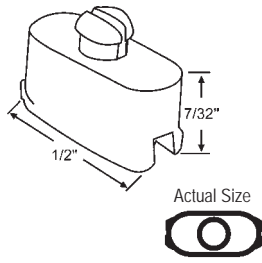

52-663

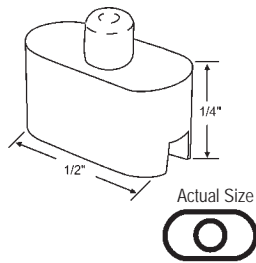

52-668

**Ador Hilde**

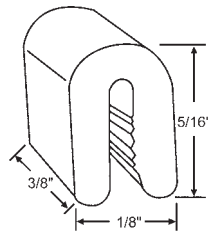

52-725

**Acorn**

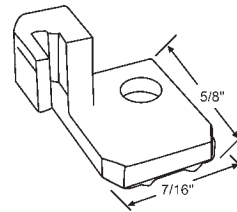

Part #	Hand
900-9556RH	Shown
900-9556LH	Opposite

**Acorn**

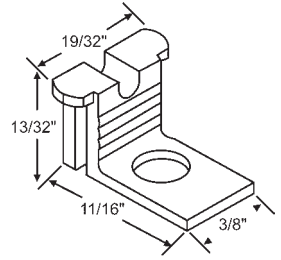

900-5215

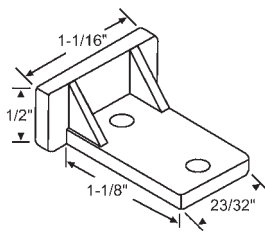

900-5159

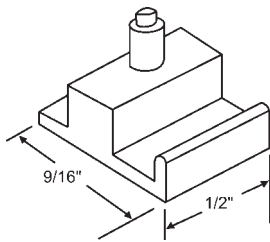

52-669

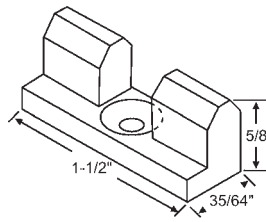

900-1987

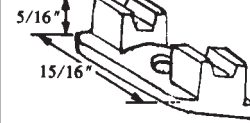

900-5766

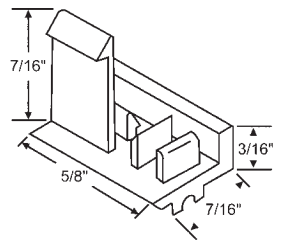

52-636  
RH Storm Slider

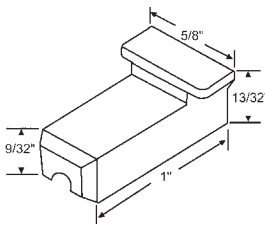

52-639

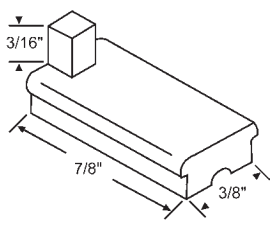

900-15187

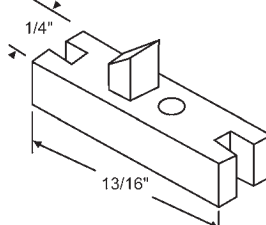

900-5593

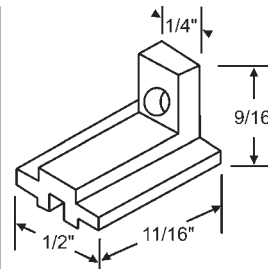

52-674

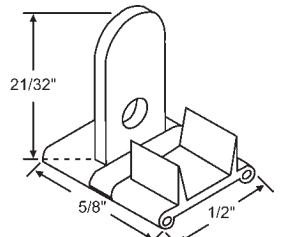

900-11181  
Black

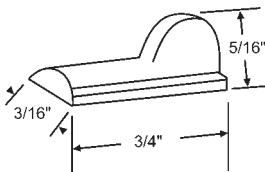

900-6902

**Crossly**

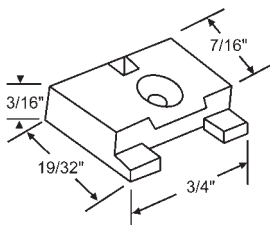

Part #	Color
52-673	Natural
52-673B	Black

Nylon  
**Crown**

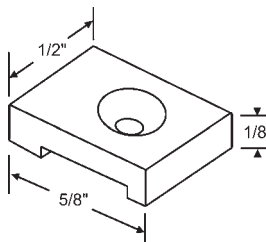

52-677

Nylon  
**Reynolds**

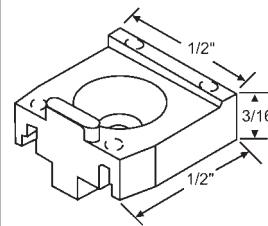

900-20307B

Black

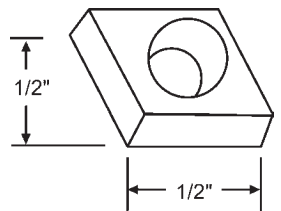

52-635  
Insert Retainer

# Window Replacement Hardware

## Slider Guides

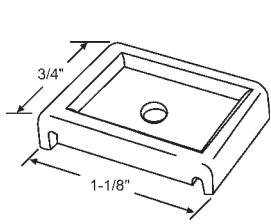

**900-11537**  
Rail Slide

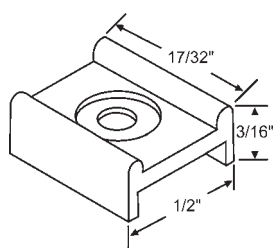

**900-5613**

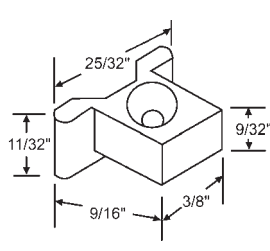

**52-602**  
Keller

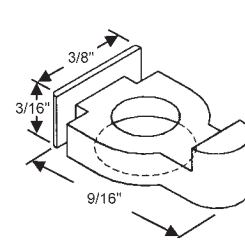

**900-5817**  
Vent Guide  
Croft

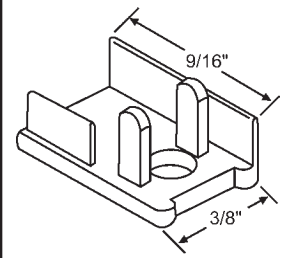

**900-20104**  
Interlock Cap  
Better Bilt

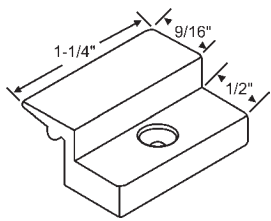

Part #	Color
900-15598	Black
900-15598W	White

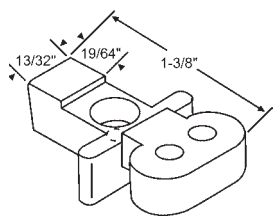

**900-14207**

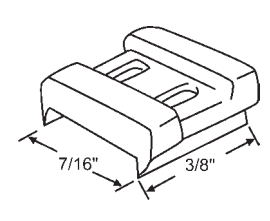

**900-21136**  
Capitol

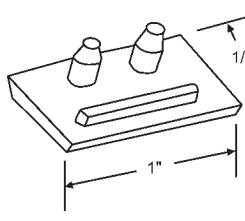

**52-664**  
Crossly

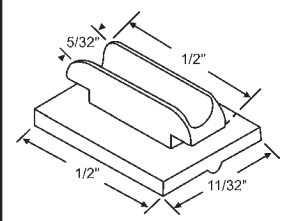

**52-665**  
Insert for 52-667

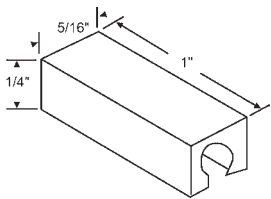

**52-829**  
Nylon Spacer, Black  
Acorn

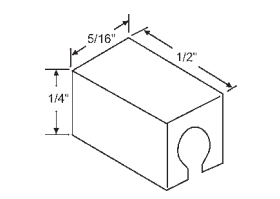

**52-828**  
Nylon Spacer, Black  
Acorn

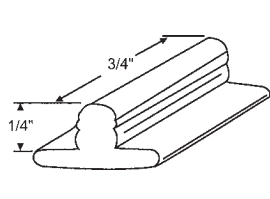

**52-706**

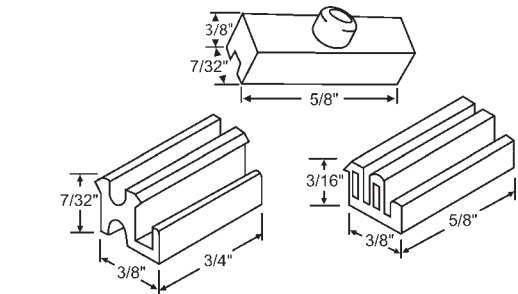

**52-720**  
Repair Kit (2 of each)  
Alenco

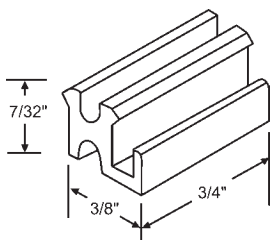

**52-608**  
Alenco

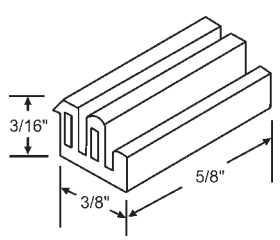

**52-670**  
Nylon  
Alenco

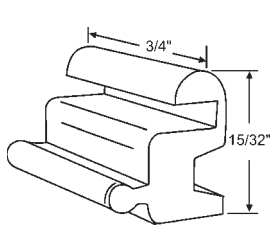

**52-845**

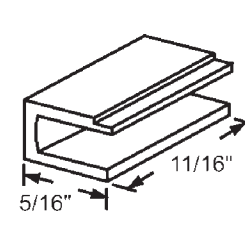

**900-6894**  
Sash Guide

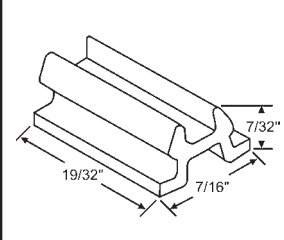

**900-1105**  
Gray

# Window Replacement Hardware

## Slider Guides

## Anti-Rattle Plug

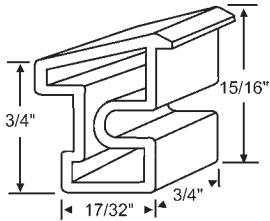

**52-7000**  
Sash Lift Stop. Black  
**Acorn**

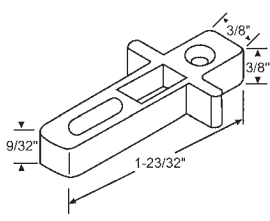

**52-600**

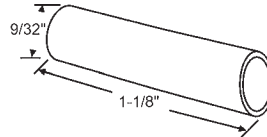

**52-633**  
Slider Pressure Tubes

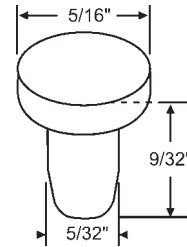

**900-2016**  
Nylon Guide

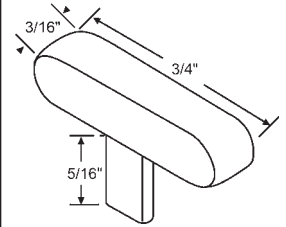

**900-2405**  
Anti-Rattle Plug

## Guide Button

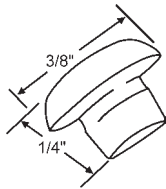

**900-15903**

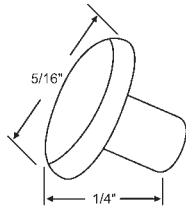

**52-607**

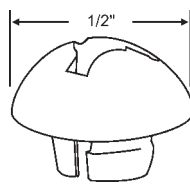

**900-9195**  
**Capitol**

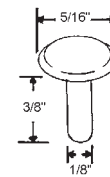

**900-2498**

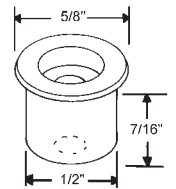

Part #	Color
900-20046B	Beige
900-20046	White

Reinforcing Button

## Angles / Corners

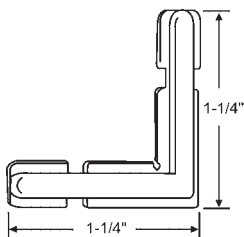

**52-605**  
Slider Guide Angle  
Plastic

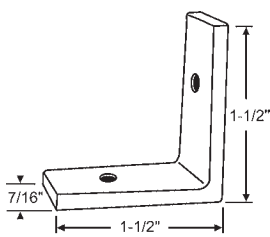

**52-604**  
Slider Guide Angle  
Aluminum

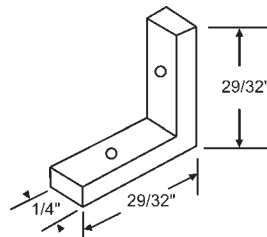

**52-603**  
Slider Corner Angle  
Die Cast

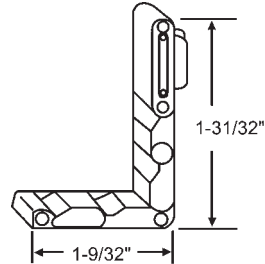

**52-667**  
Slider Corner Key  
Die Cast with Plastic Insert  
**Reynolds/Portalum**

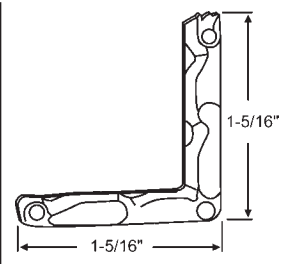

**52-672**  
Slider Corner Key  
Die Cast

## Miscellaneous

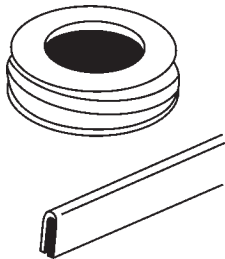

**52-705**  
Sliding Window Repair Track.  
Vinyl. Install over worn or  
damaged tracks. Sold in 100 ft.  
rolls only, Gray

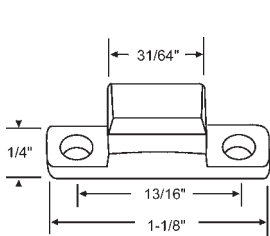

**900-2003**  
Nylon Bottom Rail Slide  
Black

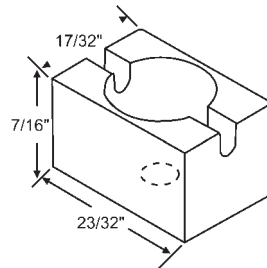

**900-5571**  
Glide Block  
**Alenco/Krestmark/  
Keller**

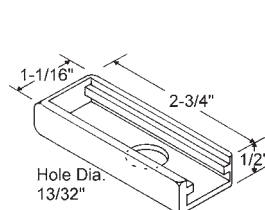

**900-20099BE** Beige  
**900-20099B** Black  
**900-20099W** White  
Slide Bolt Cover

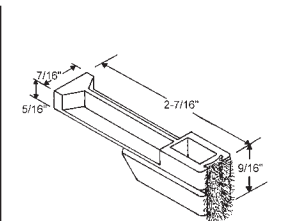

**900-20105**  
Anti-Draft Block