



Sales Rep. Name \_\_\_\_\_

Sales Rep. Ext: \_\_\_\_\_

Sales Rep. E-Mail: \_\_\_\_\_

**THE ONE STOP SOURCE FOR ALL YOUR WINDOW & DOOR HARDWARE**

- **27505 Ridge Road • Damascus, MD 20872 •**
- **1-800-992-4282 • Fax 1-301-253-8949 •**
- **www.amscousa.com • sales@amscousa.com •**





## Other Products We Carry

*We ship all across the USA*

**Bobrick & Bradley Washroom  
Accessories**

**Toilet Partitions**

**Toilet Partition Hardware**

**Grab Bars**

**Smokers' Outpost & Smokers'  
Oasis Cigarette Disposal Products**

**Cleaning Supplies**

**Koala Baby Changing Stations**

**Entrance Mats**

**Gloves**

**Locker Hardware**

**Commercial Door Stops**

**Door Closers**

**Chair Glides**

**Marsh Chalkboards, Marker  
Boards & Bulletin Boards**

**Tools**

**Fasteners**

**Casters**

**Stair Treads**

**Stop Looking Elsewhere For Your  
Replacement Hardware Needs!!  
Call Us Today: 800-992-4282**

**Fax: 301-253-8949**

**[www.amscousa.com](http://www.amscousa.com)**

**We Accept  
Visa, Mastercard & American Express**



# Window and Door Hardware

# CREDIT APPLICATION

(please print)

## Billing Information

Name	Phone	Fax
Company		
Street		
City	State	Zip

## Ship To Information (if different from above)

Name		
Company	<input type="checkbox"/> Commercial	<input type="checkbox"/> Residential
Street		
City	State	Zip

## Ownership

Individual     Partnership     Corporation     Other, explain \_\_\_\_\_

Principals

Name	Address	City, State, Zip
------	---------	------------------

Federal I.D. Number \_\_\_\_\_

Years in Business \_\_\_\_\_

## Customer Special Conditions (circle your choice)

1. PO required?	yes	no	4. Require fax acknowledgments on all orders.	yes	no
2. Monthly statements?	yes	no	5. Print your part # on packing slip?	yes	no
If yes, do you want:	<input type="checkbox"/> Email	<input type="checkbox"/> Fax	<input type="checkbox"/> Mail	6. Designate orders to:	
If no, you will only receive invoice. How do you want to receive your invoice?	<input type="checkbox"/> Email	<input type="checkbox"/> Fax	<input type="checkbox"/> Mail	a. ship complete / no back orders	
3. Print prices on packing slip?	yes	no	b. ship complete unless otherwise specified		
(not recommended for those using our drop ship program)	c. ship partials / ship back orders complete				
			d. ship partials / ship back orders as they come in		

## Bank Reference

Bank Name	Address		
Type of Account	Account #	Bank Officer's Name	Phone

## Vendor Reference

Company	Fax	
Street	Phone	
City	State	Zip
Company	Fax	
Street	Phone	
City	State	Zip
Company	Fax	
Street	Phone	
City	State	Zip

I the undersigned confirm that all information given in this application is true and correct to the best of my knowledge. I understand that terms on all purchases are net 30 days. If this application is approved, I recognize that I/we will be responsible for any attorney's fees and/or costs incurred in the collection of any unpaid balance.

Signature

Date

## TABLE OF CONTENTS

<b>Sash Support Systems</b>	<b>6-114</b>	<b>Architectural Hardware</b>	<b>115-120</b>
Overview of Balances _____	6-9	Sash Locks _____	115
Window Balance Identification Display _____	10	Lifts and Pulls _____	116
57 Series Balance and Accessories _____	11	Brass/Steel Pulleys _____	116-117
58 Series Balance and Accessories _____	11	Polysash Pulleys _____	117
60 Series Balance and Accessories _____	12-24	Sash Chain _____	117
60A and 60AX Series Balances and Accessories _____	25-26	Sash Cord and Accessories _____	118
60P Series Balances and Accessories _____	27	Sash Counterweights _____	118
60G Series Balances and Accessories _____	28-31	Accessories _____	118
61 Series Balances and Accessories _____	32-33	Spring Bolts and Miscellaneous Items _____	118
61TI Series Inverted Tilt Balance and Accessories _____	34	Vent Locks and Accessories _____	118-119
62 Series Balances _____	35-36	Casement Hardware _____	119-120
62A Series Balances _____	37-38	Screen Hardware _____	120
62 Series Accessories _____	39-42	Parting Beads/Brush Seals/Weatherstrip _____	120
62-716 Series Balance _____	43	Mini Groover _____	120
62-766 Series Balance _____	44	Hinges _____	120
62-716 & 62-766 Series Accessories _____	45-46		
Nova Flex Adhesive Sealant _____	46	<b>Window Replacement Hardware</b>	<b>121-241</b>
Spray-X Foaming Glass Cleaner _____	46	Sweep Locks & Sash Locks _____	121-128
62DV Series Balances and Accessories _____	47	Double Hung Latch _____	129
62FC Series Balances and Accessories _____	48-49	Window Keepers _____	129-133
62R Series Balances and Accessories _____	50	Slide Lock _____	133
62V Series Balances and Accessories _____	51	Spring Type Latches _____	134-135
62W Series Balances and Accessories _____	52	Extruded Sash Handles and Lifts _____	135-139
64 Series Balances and Accessories _____	53	Limit Locks and Accessories _____	139
64-841 Series Balances and Accessories _____	54	Tilt Latch Sweep Lock _____	139
64B Series Balances and Accessories _____	55	Vent Locks and Accessories _____	139 & 142
64T Series Balances and Accessories _____	56	Window Control Opening Devices (WOCD) _____	140-142
70 Series Balances and Accessories _____	57-60	Sash Restrictor Assembly Kits _____	143
72 Series Balances and Accessories _____	61-62	Sliding Window Rollers _____	143-150
74 Series Balances and Accessories _____	63-64	Weep Covers _____	150-151
75 Series Balances and Accessories _____	65	Sliding Window Wheels _____	151-152
76 Series Balances and Accessories _____	66-67	Storm Cam Latch _____	152
78A Series Balances and Accessories _____	68	Slider Guides _____	152-154
80 Series Balances and Accessories _____	69	Pivot Shoe, Slide Bolt & Anti-Rattle Plug _____	154
80A Series Balances and Accessories _____	70	Guide Buttons _____	154
80B Series Balances and Accessories _____	71	Angles/Corners _____	154-155
80SL Series Balances and Accessories _____	72	Miscellaneous _____	155
83 Series Balances and Accessories _____	73-75	Fasteners _____	155
83-P Series Balances and Accessories _____	76	Project-out Cam Handles _____	156-161
84 Series 5/8" Pneu-Lift Tilt Assembly _____	77	Project-in Handles _____	161-162
84S Series Short 5/8" Pneu-Lift Tilt Assembly _____	78	Casement Handles _____	162-165
85 Series Balances _____	79	Multi-Point Locks _____	165-166
85M Series Balances _____	80	Spring Catches _____	167
85-P Series Balances _____	81	Custodial/Vent Locks _____	167
85Z Series Balances _____	82	Removable Handle Keys _____	168
85 Series Accessories _____	83-92	Project-in, Project-out Casement Keepers and Strikes _____	168-170
88L Series Balances and Accessories _____	93-94	Face Mounted Casement Operators _____	171-177
88LL & 88SL Series Balances and Accessories _____	94	Greenhouse Operators _____	177
89 Series Balances and Accessories _____	95	Sill Mounted Casement Operators _____	178-192
Balance Tools and Accessories _____	96	Lever Operators _____	193
Tape Balances _____	97	Motorized Operators and Accessories _____	193-196
Perma-Shield Narrowline Window Balances _____	98	Manual Skylight Operators and Accessories _____	197-198
Omega Constant Force Balance System _____	99	Rear Mount Awning Operator _____	198
96BT Series Constant Force Balance and Accessories _____	99	Clerestory Window Wands _____	199
96BU Series Constant Force Balance and Accessories _____	100	Face Mounted Awning Operators _____	200
96-C Series Coiled Balance Springs and Accessories _____	101	Sill Mounted Awning Operators _____	201-204
96CQ Series Quick Tilt Constant Force Balances _____	102-103	Mill Finish Awning Operators-Miami Type _____	205
96CR Series Roller Tilt Constant Force Balance Systems _____	104	Jalousie Operators _____	206
96M Series Constant Force Balance Systems _____	105	Awning and Jalousie Accessories _____	206-208
Introduction to Vinyl Jambliners _____	106	Aluminum Awning Window Torque Bar Assemblies _____	209
Jambliner Worksheet _____	107	Torque Bar Arms _____	209-211
Tilt Jambliners with Block and Tackle Balances _____	108-109	Casement and Awning Operator Brackets _____	211-213
Heavy Duty Magnum Jambliners _____	110	Operator Covers _____	213-214
Sash Preparation Instructions for Magnum Jambliners _____	111	Crank Handles _____	214-218
Tilt Jambliners _____	112	Push Bars _____	218-219
Non-Tilt Jambliners _____	113	Vent Arms with Brackets _____	219
86 Series Non-Tilt Boston Style Jambliners _____	114	Pressure Shoes, Friction Shoes and Housings _____	220-221
		Casement and Awning Tracks _____	222-223

Continued on next page.

**Continued from previous page.**

Casement and Awning Hinges	223-230
Sash Control Devices	230-231
Top Hung Hinge Assemblies	232
Miscellaneous Operator Hardware	232-233
Finger Latches, Slide Bolts and Slide Bolt Accessories	234-236
Insert Clips	236-237
Corner Keys	237-240
C-Sash Panels and Components	241

**RV & Mobile Home Hardware 242-248**

Cranks, Knobs, Handles and Extensions	242
Operators and Operator Kits	243-244
E-Rings and Groove Pins	245
Torque Bar Bearings	245
Torque Bar Arms	245-246
Torque Bars	246
Vent Hinges	246
Window Latches, Sash Locks and Lever Latches	246-247
Jalousie Operators and Handles	247
Trailer Latch	247
Insect Screening	247
Screen Spline and Installation Tool	247
Clips	247
RV Plan-O-Gram	248

**Window Glazing & Weatherstripping 249-266**

Snap-In Vinyl Glazing Beads	249-256
Tracks	256
Muntin Bars	256
Plunger and Muntin Clips	256
Grille Pins	256
Window Grille Kit	257
Metal Glazing Bead	257-258
Vinyl Glazing Spline	258
Vinyl Glazing Channels	259
U-Channels	259
Perimeter Seals	259
Glazing Spline with Flexible Fin	259
Leaf Weatherseals	260
Foam "T" Slot Weatherseals	260
Weatherstrip	260-262
Adhesive Backed Foam Door Seals	262
Nail-Up Foam Door Seals	262
Door Sweeps	262
Foam Door Seals	262
Skirting Weatherseal	263
Glazing Clips	263
Adhesive Foam Weatherstripping Tape	263
Foam Corner Seals	263
Magnetic Weatherstrip Replacement for Steel Doors	263
E.Z.D. Glazing Tool	263
Entraseal Door Astragal Seals	264
Gray Replacement Fin Weatherstripping	264
Weatherstripping with Adhesive Backing	264
Miscellaneous	264
Edgetech Super Spacer	264
Nova Flex Adhesive Sealant	265
Caulking Applicators/Foam Guns	265
Spray-X Foaming Glass Cleaner	266
Private Label Spray-X Foaming Glass Cleaner	266

**Screening Hardware 267-298**

Custom Made Roll Form Window Screen Order Form	267
Custom Made Roll Form Window Screen Frames and Accessories	268-271
Custom Made Extruded Window Screen Order Form	272
Custom Made Extruded Window Screen Frames and Accessories	273-274
Screen Frames	275-276
Screen Wire and Screen Cloth	277-279
Screen Spline	279-280
Vinyl Atragal	280
Tension Springs	281

Wire Loop Latches	281
Screen Clips	281-283
Pivot Post	283
Hangers	283
Latches	283
Fixed Pins	283
Cross Brace Insert	283
Screen Corners	284
Grille Fastener	284
Lifts and Pull Tabs	284-285
Spring Plungers	285-286
Friction Hangers	286
Latch Set	286
Warning Label	286
Pet Screen Door	286
Screen Shield	286
Automatic Screen Door Closer	286
Extruded Aluminum Wicket & Hopper Screen Order Form	287
Roll Form & Extruded Aluminum Screen w/Plastic Wicket Order Form	288
Plastic Hinged Wickets Only	288
Custom Made Patio Screen Door Order Form	289
Custom Patio Screen Doors	290-295
Steel Multi-Fit Patio Screen Doors	296
Top Hung System for Top Rolling Application	297
Screen Tools	298

**Patio Door Hardware 299-328**

Precision Bearing Roller Assemblies	299-300
Glass Door Roller Assemblies	300-306
Screen Door Roller Assemblies	306-309
Wheels	309-310
Sliding Glass and Screen Door Keepers	310-311
Patio Door Handles	311-319
Screen Door Handles	320-321
Patio Door Screw Hole Cover	322
Screen Door Guides	322-323
Head Spacer	323
Bug Flaps	323
Fixed Panel Bracket	323
Patio Door Bumpers	323
Anti-Rattle Guides	323
Security Hardware and Patio Door Locks	324-325
Key Cylinders	325
Mortise Locks	326-327
Keepers	327-328
Latches	328
Lock Bars	328
Corner Brackets	328
Repair Tracks	328

**Swing Door Hardware 329-358**

Hoppe Single Design Theme Handles	329-330
Hoppe Swing Door Handle Sets	331
Hoppe Profile Cylinders and Rekeying Kits	332-333
Hoppe Hinges	334-335
Hoppe Multi-Point Locking Systems and Accessories	336-339
Hoppe HLS 9000 Multi-Point Hardware Swing Door Questionnaire	338
Hoppe HLS 7 Multi-Point Hardware Swing Door Questionnaire	339
G-U Multi-Point Hardware Swing Door Questionnaire	340-341
G-U Single Point Mortise Locks	341
Amesbury Multi-Point Hardware Swing Door Questionnaire	342
Amesbury Single Point Mortise Gear Box & Accessories	343
Amesbury Tru-Lock Multi-Point Conversion Kit for Entry Doors	344
Truth Sentry Multi-Point Handle Sets & Accessories	345-348
Truth Sentry Multi-Point Swing Door Questionnaire	347
Andersen Multi-Point System & Accessories	349-350
Ashland Swing Door Handle Sets & Accessories	351-353
Roto Multi-Point Systems & Accessories	354
Milton 2-Point Locksets	354
Eurogroove Stepped Router Bits	354
Hinges	355-356

**Continued from previous page.**

Miscellaneous Mortise Locks _____	356-357
Miscellaneous Swing Door Locksets & Accessories _____	357-358

**Closet Door Hardware 359-379**

Bi-Fold Closet Door Pin Assemblies _____	359-362
Bi-Fold Closet Door Caps _____	363
Bi-Fold Closet Door Springs _____	363
Bi-Fold Closet Door Accessories _____	363
Metal Closet Door Pivot Brackets _____	364
Metal Closet Door Nylon Grommets/Bushings/Bumpers _____	364-365
Metal Closet Door Plates and Pulls _____	365
Bi-Fold Door Hinge _____	365
Closet Door Track _____	365
Wood Closet Door Plunger Pins, Brackets, Plates and Caps _____	366-367
Closet Door Rollers _____	367
Wood Closet Door By-Pass Hangers _____	368-370
Wood Closet Door Panel Jacket Hangers _____	370
Wood Closet Door Pivot/Jamb Brackets _____	370-371
Wood Closet Door Pulls and Knobs _____	371
Wood Closet Door Floor Guides/Plates _____	371-372
Pivot Guide, Snuggers, Bumpers _____	372
Miscellaneous Accessories _____	372-373
Closet Door Savers _____	373
Bi-Fold Door Track Sets _____	374
CW Mirror Bi-Pass Door Hardware _____	374
CW Mirror Bi-Fold Door Hardware _____	374
E-Z Roll Closet Door Hardware _____	375-377
Paniflex Closet Door Hardware _____	377
Floataway Closet Door Hardware _____	378
Slimfold Closet Door Hardware _____	378-379

**Shower Door Hardware 380-381**

Shower Door Rollers and Roller Assemblies _____	380
Latches _____	380
Guides _____	380-381
Bumpers _____	381
Handles _____	381
Miscellaneous Accessories _____	381

**Storm Door Hardware 382-387**

Knob/Push Pull Latch Sets _____	382
Push Button Latch Set _____	382-383
VP Pull Handle Set _____	384
Lever Latch Sets _____	384
Trailer Latch Sets _____	384
Closers _____	385-386
Inside Latches _____	386
Key Locks _____	386
Panel Clips and Thumb Screws _____	387
Strikes _____	387
Shims _____	387
Hinges _____	387
Push Button _____	387
Door Chain _____	387
Brackets _____	387
Screen Spline _____	387

**General Door & Builders Hardware 388-389**

Entrance Door Closers _____	388
Door Stops, Bumpers, Silencers and Wall Protectors _____	388-389
Door Lock Channels _____	389
Door Knocker _____	389
Chain Lock _____	389
Door Viewers _____	389

**Cabinet Drawer Hardware 390-393**

Drawer Track Sets _____	390
Drawer Inserts _____	390
Monorail _____	390
Drawer Slides _____	390
Drawer Guides and Brackets _____	390-391
Sockets _____	391
Rollers _____	391-392
Hinges _____	392
Mini Door Struts _____	392
Cabinet Bumpers _____	392
Cabinet Shelf Supports and Brackets _____	392
Latch and Catch _____	392-393
Handles, Knobs & Pulls _____	393
Mirror Hardware _____	393

**Mailbox Locks 394**

Multi-Cam Mailbox Lock Kits _____	394
Fixed Cam Mailbox Locks _____	394
Flat Mailbox Locks _____	394

**Garage Door Handles 394****Toilet Partition Hardware 395-399**

Concealed and Surface Mounted Latches _____	395
Chrome Plated Door Pulls, Hooks and Door Stops _____	395
Chrome Plated Keepers and Strikes _____	396
Chrome Plated Wrap Around Gravity Pivot Hinges _____	396-397
Surface Mounted Gravity Hinges _____	397
Chrome Plated Wall Brackets _____	397
Chrome Plated Urinal Brackets _____	397-398
Replacement Pilaster Shoes _____	398
Door Inserts _____	398
Cams, Pintles and Hinge Pins _____	398-399
Chrome Plated Alcove Clips, Head Rail, End Plugs and Brackets _____	399
One-Way Screw Remover _____	399
Chrome Plated Toilet Partition Fasteners _____	399

**Commercial Door/Storefront Hardware 400-408**

Mortise Locks _____	400
Faceplates _____	400
Push/Pull Paddles _____	401
Lever Handle _____	401
Strikes _____	401
Cylinders/Trim Rings/Collars _____	402
Flush Bolt _____	402
Offset Pivots _____	403-404
Hinges _____	405
Door Closers _____	406
Door Stops & Silencers _____	406
Exit Devices _____	407-408

# SASH SUPPORT SYSTEMS

## NON-TILT SIDE LOAD CHANNEL BALANCES

The following overview will help you to locate the channel balances you are looking for. There are three basic classifications:

1. Non-Tilt Balances 2. Tilt Balances 3. Overhead Balances

We have designated each of these classifications and have made additional notes to help you determine your specific requirements.

For more information, see the detailed chart page for each individual series.

### 60 Series Non-Tilt 5/8"



- Used in aluminum windows since 1960s.
- Must always have a top and bottom guide attached.
- Many guide variations available.

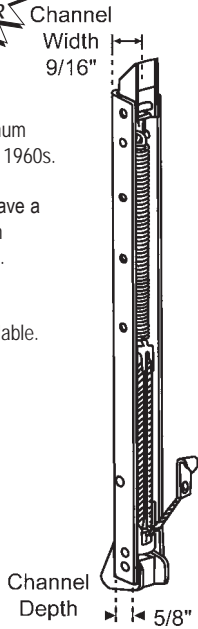

See page 12 for chart details.

### 60A & 60AX Series

The Invisible Balance

- Mounted in the side of the window sash.
- Used primarily in custom wood windows when jamb liners are not acceptable.
- Great for historical renovations.
- Original used wire cable, no longer available.

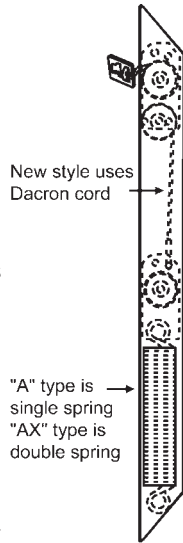

See pages 25-26 for chart details.

### 60P Series Non-Tilt

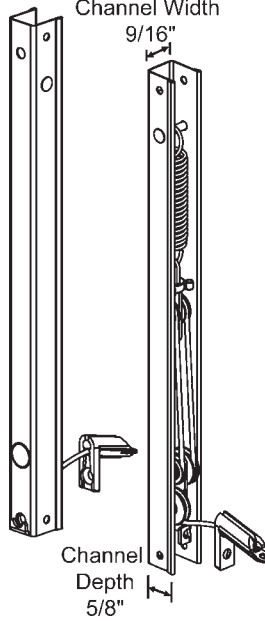

PEACHTREE

See page 27 for chart details.

### 60G Series Non-Tilt



See page 28 for chart details.

### 61 Series Non-Tilt

- This is a variation of the original 60-Series. It has a hemmed edge and in most cases has an adjustment screw.
- In most cases can use 60-Series.

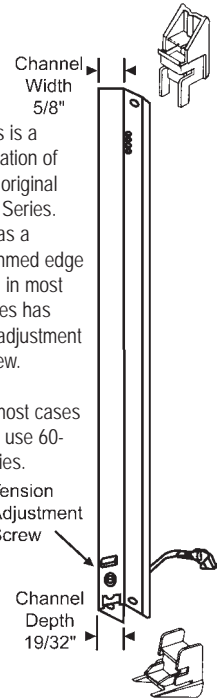

See page 32 for chart details.

## NON-TILT SIDE LOAD CHANNEL BALANCES

### 62R Series Non-Tilt



**RUSCO**  
Minimum Order Required  
See page 50 for chart details.

### 64 Series Non-Tilt 3/8"



- This is a 3/8" version of our 60-Series.
- Used primarily in Southeast.
- Binnings & Moss were 2 largest users.
- Must always have a top and bottom guide attached.

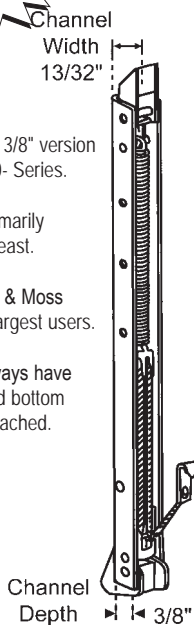

See page 53 for chart details.

### 57 Series Non-Tilt

Special Order - Non-Returnable Balance Has 2 Internal Springs

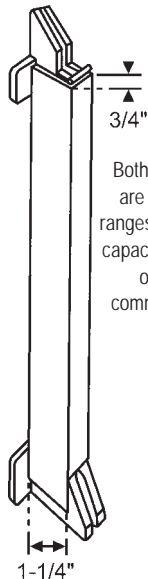

See pages 11 for chart details.

### 58 Series Non-Tilt

Special Order - Non-Returnable Balance Has 4 Internal Springs

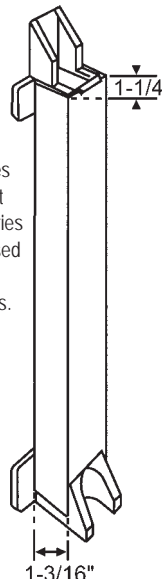

See pages 11 for chart details.

Both 57 & 58-Series are used for weight ranges above 60-series capacity. Primarily used on heavy duty commercial windows.

## TILT CHANNEL BALANCES

### 61T Series Tilt

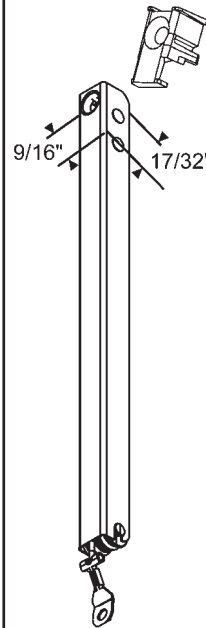

Ask account manager for detailed chart.

### 61TI Series Tilt

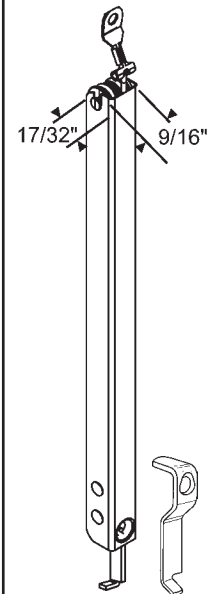

**SILVERLINE**

See page 34 for chart details.



## TILT CHANNEL BALANCES

If a window can be tilted in for cleaning and does not have a top and bottom guide attached like our 60- series, you will need one of the balances designated below.

### 62 Series Tilt 5/8"

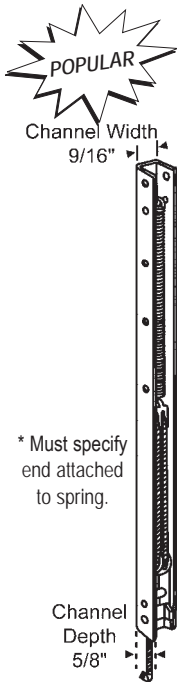

\* Must specify end attached to spring.

See page 35 for chart details.

### 64T Series Tilt 3/8"

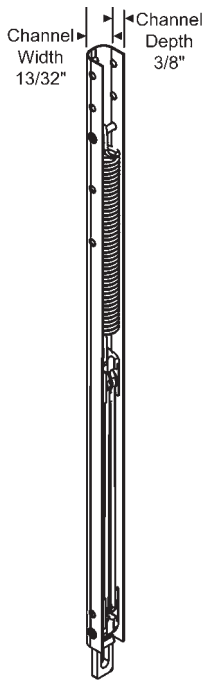

See page 56 for chart details.

### 64B Series Ribbed Balances

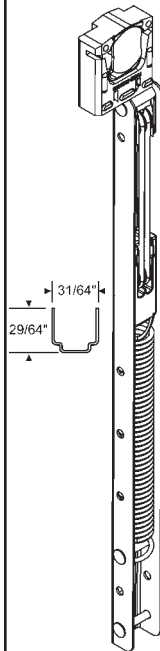

See page 55 for chart details.

### 64-841 Series Ribbed Inverted

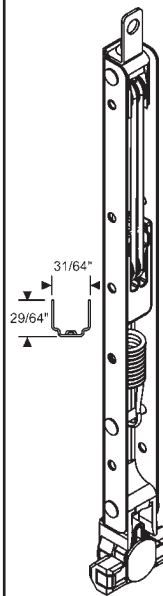

See page 54 for chart details.

### 62A Series Tilt Ribbed Balances

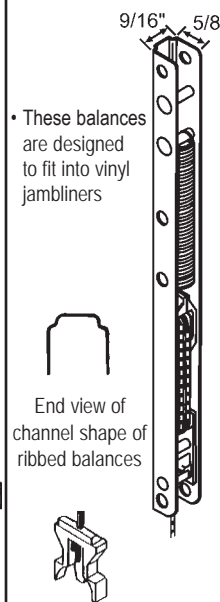

• These balances are designed to fit into vinyl jambliners

End view of channel shape of ribbed balances



See page 37 for chart details.

### 62FC Series

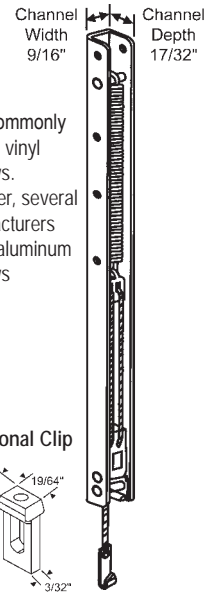

• Most commonly used in vinyl windows. However, several manufacturers use in aluminum windows

Optional Clip

See page 48 for chart details.

### 62G Series

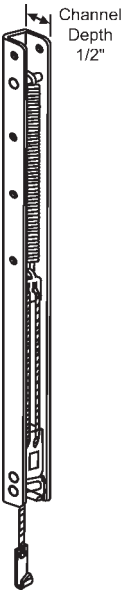

Ask account manager for detailed chart.

## TILT CHANNEL BALANCES

## OVERHEAD BALANCES

### 62-716 Series

Inverted.  
1/2" Wide x  
1/2" Depth



See page 43 for chart details.

### 62-766 Series

Inverted.  
1/2" Wide x  
1/2" Depth  
(Similar to 62-716 Series  
Except 4 numbers  
Stamped on Balance)

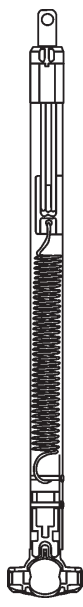

See page 44 for chart details.

### 62M Series

Used on  
Magnum  
#86M,  
86MF, 86MS  
Jambliners



Ask account manager for detailed chart.

### 62W Series Overhead Balances

• Used primarily in West Coast by international and other manufacturers

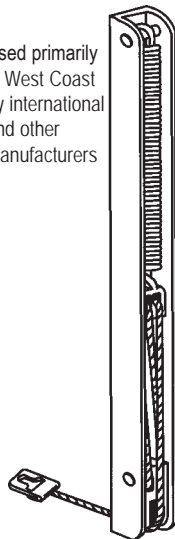

See page 52 for chart details.

### 62DV Series Devac Balances

Channel Height 5/8"  
Channel Width 9/16"  
Single Spring Channel

Channel Height 13/16"  
Channel Width 9/16"  
Double Spring Channel

Minimum Order Required

See page 47 for chart details.

### 62V Series

5 to 1 Overhead Balances

• Original design used wire cable. New design uses Dacron® Cord.

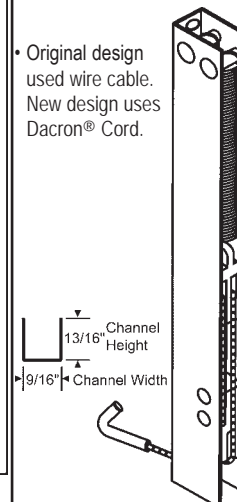

Minimum Order Required

See page 51 for chart details.

### 60B Series Bantam Balances

• One of the first overhead balances  
• Used primarily by Binswanger  
• Not currently used by any manufacturer

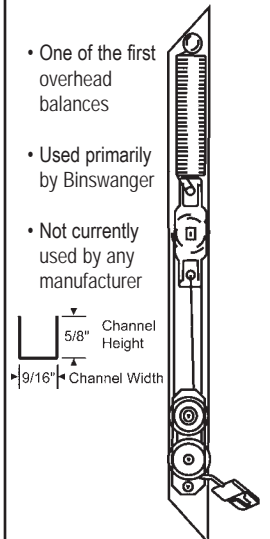

Ask account manager for detailed chart.

# SASH SUPPORT SYSTEMS

## TILT & NON-TILT SPIRAL BALANCES

### 85 Series Tilt 5/8"



- Most popular spiral tilt in the industry
- Used in aluminum and vinyl windows
- Has 2 pins at end of rod
- Metal Tube

Now Available in White!

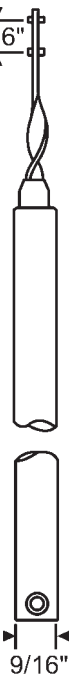

See page 79 for chart details.

### 85M Series Tilt 5/8"



See page 80 for chart details.

### 85Z Series Pre-Tensioned Tilt 5/8"



See page 82 for chart details.

### 85-P Series Tilt 5/8"

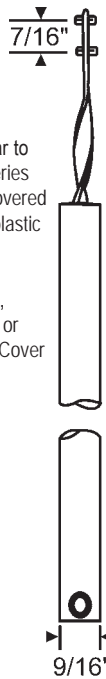

- Similar to 85 Series but covered with plastic tube
- White, Black or Gray Cover

See page 81 for chart details.

### 83 Series Tilt 3/8"

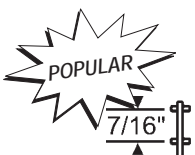

- Used primarily in lighter windows in Southeast and Southwest.
- Metal Tube

Now Available in White and Black!



See page 73 for chart details.

### 83-P Series Tilt 3/8"

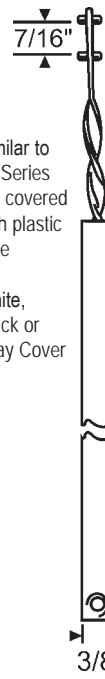

- Similar to 83 Series but covered with plastic tube
- White, Black or Gray Cover

See page 76 for chart details.

### 84 Series PneuLift

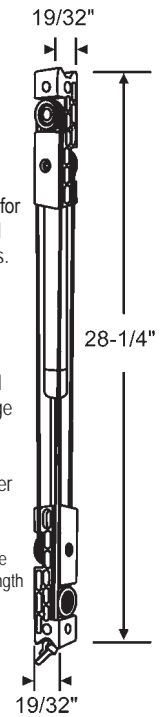

- Pneumatic for commercial applications.
- Gas filled balance.
- Can extend weight range to over 100 lbs. with 4 balances per sash.

\* Also available in 20-1/4" length version as 84S Series.

See page 77 for chart details.

### 89 Series Non-Tilt 5/8"

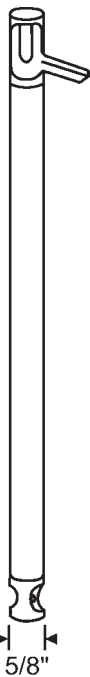

- Wood Windows
- White Tube

**CARADCO**

See page 95 for chart details.

### 88L Series Tilt or Non-Tilt



- Commercial Grade Heavy Duty up to 100 lbs.
- Reduces lifting and closing force by over 50%. Excellent for schools, nursing homes, hospitals, etc.
- By utilizing 88-500 bracket, balance can be made Non-Tilt.
- 5 year warranty
- Gray Plastic Cover
- Must be ordered for specific weight.

Now Available in White!

See page 93 for chart details.

### 88LL Series Tilt & Non-Tilt



- Commercial Grade Heavy Duty for weight ranges up to 130 lbs.
- Gray, Black or White Cover

See page 89 94 chart details.

### 88SL Series Tilt & Non-Tilt

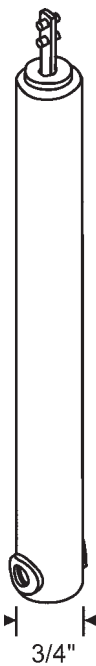

### 89W Series

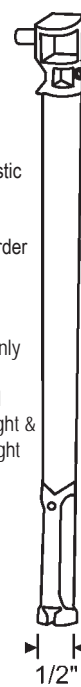

- White Plastic Tube
- Special Order Item
- Order Per Sample Only
- Also Need Sash Weight & Glass Height

**WENCO**

Ask account manager for detailed chart.

### 70 Series Non-Tilt 5/8"

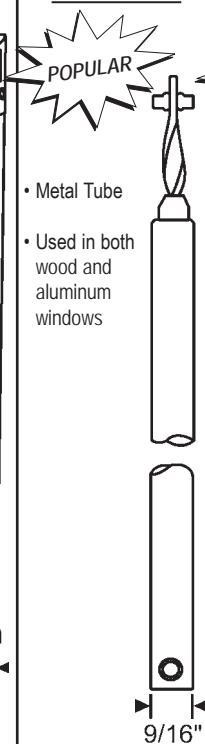

- Metal Tube
- Used in both wood and aluminum windows

See page 57 for chart details.

### 76 Series Non-Tilt 3/8"

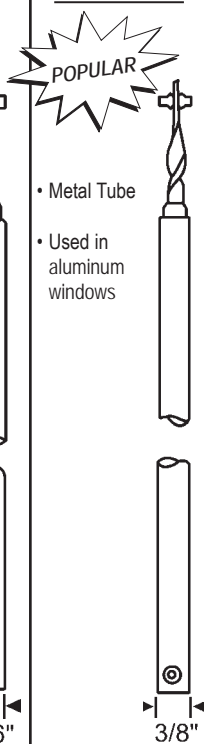

- Metal Tube
- Used in aluminum windows

See page 66 for chart details.

## NON-TILT SPIRAL BALANCES

72 Series Non-Tilt	74 Series Non-Tilt	75 Series Non-Tilt	78A Series Non-Tilt 3/8"	78B Series	78C Series
<p><b>POPULAR</b></p> <p>5/8"</p> <p>Hole to Hole</p>	<p><b>POPULAR</b></p> <p>1/2"</p> <p>Hole to Hole</p>	<p><b>POPULAR</b></p> <p>9/32"</p> <p>Hole to Hole</p>		<p>11/32"</p> <p>80-604</p>	<p>3/8"</p> <p>80-605</p>
<ul style="list-style-type: none"> <li>• Metal Tube</li> <li>• Always has plastic end attached.</li> <li>• Do not confuse with 85 tilt series.</li> </ul> <p>72-500</p> <p>9/16"</p>	<ul style="list-style-type: none"> <li>• Metal Tube</li> <li>• Always has plastic end attached.</li> <li>• Do not confuse with 83 tilt series.</li> </ul> <p>74-501</p> <p>3/8"</p>	<ul style="list-style-type: none"> <li>• Metal Tube</li> <li>• Always has metal guide attached.</li> <li>• Do not confuse with 83 tilt series.</li> </ul> <p>Note: The difference between our "74" and "75" series balances is in the hole center distance in the spiral rod.</p> <p>3/8"</p>	<ul style="list-style-type: none"> <li>• Plastic Tube</li> </ul> <p>3/8"</p>	<ul style="list-style-type: none"> <li>• Plastic Tube</li> </ul> <p>3/8"</p>	<ul style="list-style-type: none"> <li>• Plastic Tube</li> </ul> <p>3/8"</p>
See page 61 for chart details.	See page 63 for chart details.	See page 65 for chart details.	<p><b>VE ANDERSON</b></p> <p>See page 68 for chart details.</p>	Ask account manager for detailed chart.	Ask account manager for detailed chart.

78SL Series	78M Series	80SL Series	80 Series Non-Tilt	80A Series Non-Tilt	80B Series Non-Tilt	Type M Series 13/16"
<p>3/8"</p>	<p>3/8"</p>	<p>5/8"</p>	<p>9/16"</p>	<p>9/16"</p>	<p>9/16"</p>	<p>13/16"</p>
<ul style="list-style-type: none"> <li>• Plastic Tube</li> </ul>	<ul style="list-style-type: none"> <li>• Metal Tube</li> </ul>	<ul style="list-style-type: none"> <li>• Plastic Tube</li> </ul>	<ul style="list-style-type: none"> <li>• Gray Plastic Tube</li> </ul>	<ul style="list-style-type: none"> <li>• Gray Plastic Tube</li> <li>• Primarily used in New York and New Jersey</li> </ul>	<ul style="list-style-type: none"> <li>• Black Plastic Tube</li> </ul>	<ul style="list-style-type: none"> <li>• Old style was metal tube, now all plastic tube</li> <li>• Gray Plastic Tube</li> <li>• Order per sample only</li> </ul>
Ask account manager for detailed chart.	<p><b>ROBERT E. LEE</b></p> <p>Ask account manager for detailed chart.</p>	See page 72 for chart details.	<p><b>AIRMASTER</b></p> <p>See page 69 for chart details.</p>	See page 70 for chart details.	See page 71 for chart details.	Ask account manager for detailed chart.

# Window Balance Identification Display



**NEW**



Other Side

- Includes an assortment of 31 different series channel (Tilt & Non-tilt), tube (Tilt & Non-tilt), and constant force window sash balance samples.
- Counter top display included. (Made of plastic and shipped knocked down)
- Sign included for the top of the display.
- Balances are Velcro on so they are removable for sample identification and/or transport to site for identification. Each balance is labeled with balance series. Rack is also labeled so the balance samples can be returned to the proper position.
- Also available is a generic "Any Balance for Any Window" flyer that can be customized with your company name & address in a PDF format, to print and hand out (or e-mail) to your customers and for your sales/installation/quote personnel.
- Display rack spins around 360 degrees.
- Display size is approx. 13" wide x 13" deep x 24" high.
- Also great for sales/customer meetings, customer shows/exhibits, open house, training, and other events.
- Well worth the investment and will pay for itself in a short period of time as you increase your balance sales.

**Part Number: 500-326**

## 57 SERIES NON-TILT BALANCES

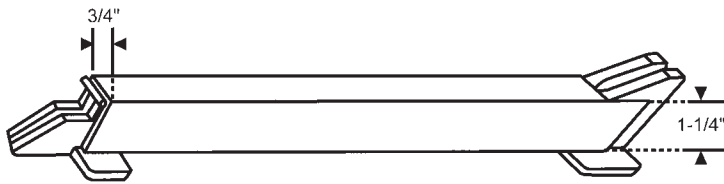

**-Max Weight 75lbs.**

**Note: These are special order balances and are not returnable.**

### ORDERING INFORMATION

1. Measure metal channel length. Do not include any attached ends.
2. Check number stamped on channel. The first two digits represents the channel length. The second two digits represent the sash weight. (e.g.: The number stamped on the balance is 3248, you would then order #57-32S48. With 57 referring to our series, followed by the length of the balance then the sash weight.)

**Note:** Top and bottom guides shown below will automatically be attached to your balance unless otherwise specified.

**Note:** With the 58 Series take out system, the sash balance becomes part of the sash. Therefore, when calculating sash weights, you must add the physical balance weight to the sash weights.

TOP GUIDE	BOTTOM GUIDE	SASH CAP	TAKE-OUT CLIP
<p><b>57-500</b></p>	<p><b>57-501</b></p>	<p><b>57-600</b> Black Anodized Aluminum <b>TRACO</b></p>	<p><b>58-700</b> Zinc Plated</p>

## 58 SERIES NON-TILT BALANCES

**58 Series Balances are Designed for Heavy Duty Commercial Windows**

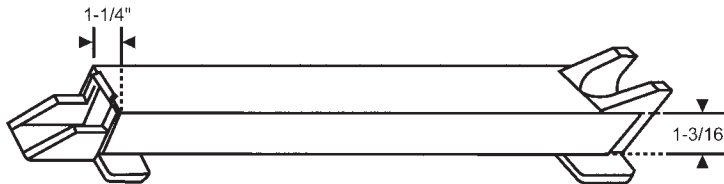

**-Max Weight 100lbs.**

**Note: These are special order balances and are not returnable.**

### ORDERING INFORMATION

1. Measure metal channel length. Do not include any attached ends.
2. Check number stamped on channel. The first two digits represents the channel length. The second two digits represent the sash weight. (e.g.: The number stamped on the balance is 3248, you would then order #58-32S48. With 58 referring to our series, followed by the length of the balance then the sash weight.)

**Note:** Top and bottom guides shown below will automatically be attached to your balance unless otherwise specified.

**Note:** With the 58 Series take out system, the sash balance becomes part of the sash. Therefore, when calculating sash weights, you must add the physical balance weight to the sash weights.

TOP GUIDE	BOTTOM GUIDE	CAM	TAKE-OUT CLIP
<p><b>58-500</b></p>	<p><b>58-501</b></p>	<p><b>58-600</b></p>	<p><b>58-700</b> Zinc Plated</p>

# SASH SUPPORT SYSTEMS

## 60 SERIES CHANNEL BALANCES

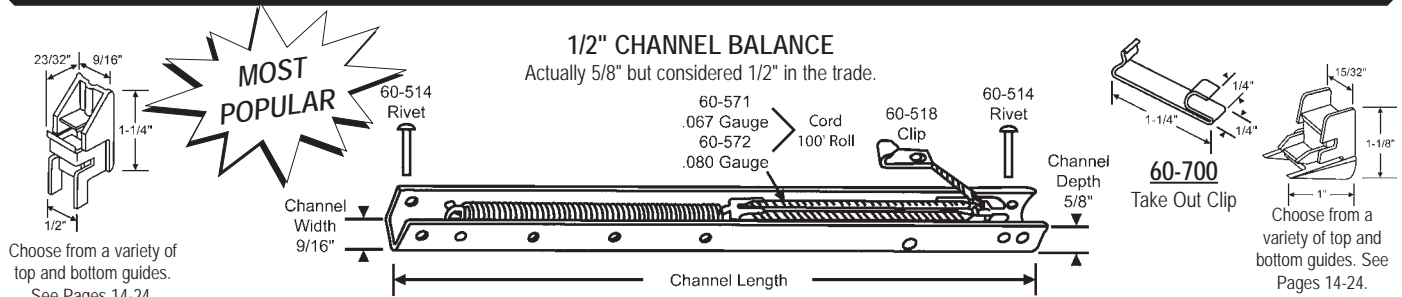

### General Information

- Sash weights indicated below are weights that 2 balances per sash will carry with no weather-strip friction considered.
- Balances stamped with a 3-digit number (e.g. 122, 183, 143) or a 2-digit number (e.g. 15, 18, 19) will require you to contact your account manager for more information; such as exact channel length, type of ends attached, etc.
- Any other number/letter variations should also be reviewed with your account manager to ensure your order will be filled correctly.
- If your existing balance has a "BSI" stamped on the face of the balance by the 4 digit number, order exactly as seen on this chart.
- If your existing balance does not have BSI stamped on it and your balance's 4 digit number has a 40 suffix (e.g. 2840, 2940, 3040, 3640 etc.), you have the old style balance and for 29" balances and above -order 2850, 2950, 3050, 3650, etc. If you are unsure, weigh your sash and choose from the weight charts indicated below.
- For sash weights over those indicated on chart below, please provide the following information:
  - Number stamped on balance \_\_\_\_\_
  - Balance length (do not include ends \_\_\_\_\_)
  - Sash weight \_\_\_\_\_
  - Upper or lower sash \_\_\_\_\_
  - e) 2 or 4 balances per sash \_\_\_\_\_

**Note:** Special weight balances were usually stamped with a 4 digit number followed by a two digit number to designate specific weight (e.g. 2640 42 or 2690 42 indicates (2) 27" balances carrying 42 lb. sash.

### Ordering Information

- Measure metal channel balance length. (Do not include plastic ends.)
  - Check number stamped on channel. (e.g. 2010, 28A, 3620 etc.)
  - Select our corresponding part number from the chart below.
  - To identify the top and bottom ends to be attached, refer to pages 14-24.
- Note:** Top and bottom balance ends must be ordered separately. If you want ends attached, add the letter "A" to the suffix of the part number when ordering. If you find the ends you need and they are located with the popular combinations, look for the suffix number and just add that suffix number to the end of the balance part number you selected (e.g. balance 60-242 with ends 60-507 and 60-501 add the suffix -1 so the final part number is 60-242-1).

### Please Note (Important New Information)

Due to increased demand for larger and heavier windows, manufacturers have increased the weight capacity of balances as indicated by our expanded chart. Previously, balances beyond the traditional weight ranges were made for a specific length, weight and often required limited travel and needed to specify upper and lower sash. The examples below show the versatility of the new weight ranges and allow us to inventory these balances to cover a broader range of windows

**Examples:** Old Number 60-26S42L (27" 42lb - Lower Sash)      New Number 60-2680 (27" 42-45lb)  
 60-26S42U (27" 42lb - Upper Sash)  
 60-26S44L (27" 44lb. - Lower Sash)  
 60-26S44U (27" 44lb. - Upper Sash)

All balances listed in this chart no longer need to designate upper or lower and they all have full travel. Balances with weights and lengths above those listed on the chart will require sash weight and upper or lower designation and will have limited travel

**Example:** 27" Channel balance for 49lb. sash  
 60-26S49 (for lower sash)  
 60-26S49U (for upper sash)

For weights above those listed in this chart, see next page.

Length of Metal Channel	Number Stamped on Balance	Sash Weight	Our Part Number	Length of Metal Channel	Number Stamped on Balance	Sash Weight	Our Part Number	Length of Metal Channel	Number Stamped on Balance	Sash Weight	Our Part Number	Length of Metal Channel	Number Stamped on Balance	Sash Weight	Our Part Number
13"	1210	3-6 lbs	60-121	17"	1660	22-25 lbs	60-1660	21"	2020	8-12 lbs	60-202	24"	2370	34-37 lbs	60-2370
13"	1220	6-9 lbs	60-122	17"	1665	25-29 lbs	60-1665	21"	2030	12-15 lbs	60-203	24"	2375	37-40 lbs	60-2375
13"	1230	9-11 lbs	60-123	18"	1710	5-8 lbs	60-171	21"	2040	15-23 lbs	60-204	25"	2410	5-9 lbs	60-241
13"	1240	11-12 lbs	60-124	18"	1720	8-12 lbs	60-172	21"	2050	23-27 lbs	60-2050	25"	2420	9-15 lbs	60-242
13"	1250	12-15 lbs	60-1250	18"	1730	12-14 lbs	60-173	21"	2060	27-30 lbs	60-2060	25"	2430	15-19 lbs	60-243
13"	1260	15-18 lbs	60-1260	18"	1740	14-17 lbs	60-174	21"	2065	30-34 lbs	60-2065	25"	2440	19-24 lbs	60-244
14"	1310	3-6 lbs	60-131	18"	1750	17-20 lbs	60-1750	21"	2070	34-37 lbs	60-2070	25"	2450	24-27 lbs	60-2450
14"	1320	6-9 lbs	60-132	18"	1760	20-23 lbs	60-1760	21"	2075	37-40 lbs	60-2075	25"	2460	27-30 lbs	60-2460
14"	1330	9-11 lbs	60-133	18"	1765	23-25 lbs	60-1765	22"	2110	5-8 lbs	60-211	25"	2465	30-33 lbs	60-2465
14"	1340	11-12 lbs	60-134	18"	1770	25-29 lbs	60-1770	22"	2120	8-12 lbs	60-212	25"	2470	33-36 lbs	60-2470
14"	1350	12-15 lbs	60-1350	18"	1775	29-32 lbs	60-1775	22"	2130	12-15 lbs	60-213	25"	2475	36-39 lbs	60-2475
14"	1360	15-18 lbs	60-1360	19"	1810	5-8 lbs	60-181	22"	2140	15-23 lbs	60-214	25"	2480	39-42 lbs	60-2480
14"	1365	18-20 lbs	60-1365	19"	1820	8-12 lbs	60-182	22"	2150	23-27 lbs	60-2150	25"	2485	42-45 lbs	60-2485
15"	1410	4-6 lbs	60-141	19"	1830	12-14 lbs	60-183	22"	2160	27-30 lbs	60-2160	26"	2510	5-9 lbs	60-251
15"	1420	6-10 lbs	60-142	19"	1840	14-17 lbs	60-184	22"	2165	30-34 lbs	60-2165	26"	2520	9-15 lbs	60-252
15"	1430	10-12 lbs	60-143	19"	1850	17-20 lbs	60-1850	22"	2170	34-37 lbs	60-2170	26"	2530	15-19 lbs	60-253
15"	1440	12-13 lbs	60-144	19"	1860	20-23 lbs	60-1860	22"	2175	37-40 lbs	60-2175	26"	2540	19-25 lbs	60-254
15"	1450	13-17 lbs	60-1450	19"	1865	23-25 lbs	60-1865	23"	2210	5-8 lbs	60-221	26"	2550	25-28 lbs	60-2550
15"	1460	17-20 lbs	60-1460	19"	1870	25-29 lbs	60-1870	23"	2220	8-12 lbs	60-222	26"	2560	28-30 lbs	60-2560
15"	1465	20-23 lbs	60-1465	19"	1875	29-32 lbs	60-1875	23"	2230	12-19 lbs	60-223	26"	2565	30-33 lbs	60-2565
16"	1510	4-6 lbs	60-151	19"	1880	32-35 lbs	60-1880	23"	2240	19-23 lbs	60-224	26"	2570	33-36 lbs	60-2570
16"	1520	6-10 lbs	60-152	20"	1910	5-8 lbs	60-191	23"	2250	23-27 lbs	60-2250	26"	2575	36-39 lbs	60-2575
16"	1530	10-12 lbs	60-153	20"	1920	8-12 lbs	60-192	23"	2260	27-30 lbs	60-2260	26"	2580	39-42 lbs	60-2580
16"	1540	12-13 lbs	60-154	20"	1930	12-14 lbs	60-193	23"	2265	30-34 lbs	60-2265	26"	2585	42-45 lbs	60-2585
16"	1550	13-17 lbs	60-1550	20"	1940	14-17 lbs	60-194	23"	2270	34-37 lbs	60-2270	27"	2610	5-9 lbs	60-261
16"	1560	17-20 lbs	60-1560	20"	1950	17-21 lbs	60-1950	23"	2275	37-40 lbs	60-2275	27"	2620	9-13 lbs	60-262
16"	1565	20-23 lbs	60-1565	20"	1960	21-24 lbs	60-1960	24"	2310	5-8 lbs	60-231	27"	2630	13-19 lbs	60-263
16"	1570	23-26 lbs	60-1570	20"	1965	24-27 lbs	60-1965	24"	2320	9-15 lbs	60-232	27"	2640	19-26 lbs	60-264
17"	1610	5-8 lbs	60-161	20"	1970	27-30 lbs	60-1970	24"	2330	15-18 lbs	60-233	27"	2650	26-30 lbs	60-2650
17"	1620	8-12 lbs	60-162	20"	1975	30-34 lbs	60-1975	24"	2340	18-23 lbs	60-234	27"	2660	30-33 lbs	60-2660
17"	1630	12-14 lbs	60-163	20"	1980	34-37 lbs	60-1980	24"	2350	23-27 lbs	60-2350	27"	2665	33-36 lbs	60-2665
17"	1640	14-19 lbs	60-164	20"	1985	37-40 lbs	60-1985	24"	2360	27-30 lbs	60-2360	27"	2670	36-39 lbs	60-2670
17"	1650	19-22 lbs	60-1650	21"	2010	5-8 lbs	60-201	24"	2365	30-34 lbs	60-2365	27"	2675	39-42 lbs	60-2675

Continued on next page

## 60 SERIES CHANNEL BALANCES

Continued from previous page

Length of Metal Channel	Number Stamped on Balance	Sash Weight	Our Part Number	Length of Metal Channel	Number Stamped on Balance	Sash Weight	Our Part Number	Length of Metal Channel	Number Stamped on Balance	Sash Weight	Our Part Number	Length of Metal Channel	Number Stamped on Balance	Sash Weight	Our Part Number
27"	2680	42-45 lbs	60-2680	34"	3370	39-42 lbs	60-3370	42"	4160	35-39 lbs	60-4160	50"	4950	30-35 lbs	60-4950
28"	2710	5-9 lbs	60-271	34"	3375	42-45 lbs	60-3375	42"	4165	39-42 lbs	60-4165	50"	4960	35-39 lbs	60-4960
28"	2720	9-13 lbs	60-272	35"	3410	8-13 lbs	60-341	42"	4170	42-45 lbs	60-4170	50"	4965	39-42 lbs	60-4965
28"	2730	13-19 lbs	60-273	35"	3420	13-18 lbs	60-342	43"	4210	9-14 lbs	60-421	50"	4970	42-45 lbs	60-4970
28"	2740	19-26 lbs	60-274	35"	3430	18-23 lbs	60-343	43"	4220	14-19 lbs	60-422	51"	5010	4-14 lbs	60-501
28"	2750	26-30 lbs	60-2750	35"	3440	23-30 lbs	60-344	43"	4230	19-24 lbs	60-423	51"	5020	14-19 lbs	60-502
28"	2760	30-33 lbs	60-2760	35"	3450	30-34 lbs	60-3450	43"	4240	24-30 lbs	60-424	51"	5030	19-25 lbs	60-503
28"	2765	33-36 lbs	60-2765	35"	3460	34-39 lbs	60-3460	43"	4250	30-35 lbs	60-4250	51"	5040	25-32 lbs	60-504
28"	2770	36-39 lbs	60-2770	35"	3465	39-42 lbs	60-3465	43"	4260	35-39 lbs	60-4260	51"	5050	32-35 lbs	60-5050
28"	2775	39-42 lbs	60-2775	35"	3470	42-45 lbs	60-3470	43"	4265	39-42 lbs	60-4265	51"	5060	35-39 lbs	60-5060
28"	2780	42-45 lbs	60-2780	36"	3510	8-13 lbs	60-351	43"	4270	42-45 lbs	60-4270	51"	5065	39-42 lbs	60-5065
29"	2810	7-12 lbs	60-281	36"	3520	13-18 lbs	60-352	44"	4310	9-14 lbs	60-431	51"	5070	42-45 lbs	60-5070
29"	2820	12-16 lbs	60-282	36"	3530	18-23 lbs	60-353	44"	4320	14-19 lbs	60-432	52"	5110	4-14 lbs	60-511
29"	2830	16-23 lbs	60-283	36"	3540	23-30 lbs	60-354	44"	4330	19-24 lbs	60-433	52"	5120	14-19 lbs	60-512
29"	2840	23-28 lbs	60-284	36"	3550	30-35 lbs	60-3550	44"	4340	24-30 lbs	60-434	52"	5130	19-25 lbs	60-513
29"	2850	28-32 lbs	60-2850	36"	3560	35-39 lbs	60-3560	44"	4350	30-35 lbs	60-4350	52"	5140	25-32 lbs	60-514
29"	2860	32-35 lbs	60-2860	36"	3565	39-42 lbs	60-3565	44"	4360	35-39 lbs	60-4360	52"	5150	32-35 lbs	60-5150
29"	2865	35-39 lbs	60-2865	36"	3570	42-45 lbs	60-3570	44"	4365	39-42 lbs	60-4365	52"	5160	35-39 lbs	60-5160
29"	2870	39-42 lbs	60-2870	37"	3610	8-13 lbs	60-361	44"	4370	42-45 lbs	60-4370	52"	5165	39-42 lbs	60-5165
29"	2875	42-45 lbs	60-2875	37"	3620	13-18 lbs	60-362	45"	4410	9-14 lbs	60-441	52"	5170	42-45 lbs	60-5170
30"	2910	7-12 lbs	60-291	37"	3630	18-23 lbs	60-363	45"	4420	14-19 lbs	60-442	53"	5210	4-14 lbs	60-521
30"	2920	12-16 lbs	60-292	37"	3640	23-30 lbs	60-364	45"	4430	19-24 lbs	60-443	53"	5220	14-19 lbs	60-522
30"	2930	16-23 lbs	60-293	37"	3650	30-35 lbs	60-3650	45"	4440	24-30 lbs	60-444	53"	5230	19-25 lbs	60-523
30"	2940	23-28 lbs	60-294	37"	3660	35-39 lbs	60-3660	45"	4450	30-35 lbs	60-4450	53"	5240	25-32 lbs	60-524
30"	2950	28-32 lbs	60-2950	37"	3665	39-42 lbs	60-3665	45"	4460	35-39 lbs	60-4460	53"	5250	32-35 lbs	60-5250
30"	2960	32-35 lbs	60-2960	37"	3670	42-45 lbs	60-3670	45"	4465	39-42 lbs	60-4465	53"	5260	35-39 lbs	60-5260
30"	2965	35-39 lbs	60-2965	38"	3710	8-13 lbs	60-371	45"	4470	42-45 lbs	60-4470	53"	5265	39-42 lbs	60-5265
30"	2970	39-42 lbs	60-2970	38"	3720	13-18 lbs	60-372	46"	4510	9-14 lbs	60-451	53"	5270	42-45 lbs	60-5270
30"	2975	42-45 lbs	60-2975	38"	3730	18-23 lbs	60-373	46"	4520	14-19 lbs	60-452	54"	5310	4-14 lbs	60-531
31"	3010	7-12 lbs	60-301	38"	3740	23-30 lbs	60-374	46"	4530	19-24 lbs	60-453	54"	5320	14-19 lbs	60-532
31"	3020	12-16 lbs	60-302	38"	3750	30-35 lbs	60-3750	46"	4540	24-30 lbs	60-454	54"	5330	19-25 lbs	60-533
31"	3030	16-23 lbs	60-303	38"	3760	35-39 lbs	60-3760	46"	4550	30-35 lbs	60-4550	54"	5340	25-32 lbs	60-534
31"	3040	23-28 lbs	60-304	38"	3765	39-42 lbs	60-3765	46"	4560	35-39 lbs	60-4560	54"	5350	32-35 lbs	60-5350
31"	3050	28-32 lbs	60-3050	38"	3770	42-45 lbs	60-3770	46"	4565	39-42 lbs	60-4565	54"	5360	35-39 lbs	60-5360
31"	3060	32-35 lbs	60-3060	39"	3810	9-14 lbs	60-381	46"	4570	42-45 lbs	60-4570	54"	5365	39-42 lbs	60-5365
31"	3065	35-39 lbs	60-3065	39"	3820	14-19 lbs	60-382	47"	4610	9-14 lbs	60-461	54"	5370	42-45 lbs	60-5370
31"	3070	39-42 lbs	60-3070	39"	3830	19-24 lbs	60-383	47"	4620	14-19 lbs	60-462				
31"	3075	42-45 lbs	60-3075	39"	3840	24-30 lbs	60-384	47"	4630	19-24 lbs	60-463				
32"	3110	7-12 lbs	60-311	39"	3850	30-35 lbs	60-3850	47"	4640	24-30 lbs	60-464				
32"	3120	12-16 lbs	60-312	39"	3860	35-39 lbs	60-3860	47"	4650	30-35 lbs	60-4650				
32"	3130	16-23 lbs	60-313	39"	3865	39-42 lbs	60-3865	47"	4660	35-39 lbs	60-4660				
32"	3140	23-28 lbs	60-314	39"	3870	42-45 lbs	60-3870	47"	4665	39-42 lbs	60-4665				
32"	3150	28-32 lbs	60-3150	40"	3910	9-14 lbs	60-391	47"	4670	42-45 lbs	60-4670				
32"	3160	32-35 lbs	60-3160	40"	3920	14-19 lbs	60-392	48"	4710	9-14 lbs	60-471				
32"	3165	35-39 lbs	60-3165	40"	3930	19-24 lbs	60-393	48"	4720	14-19 lbs	60-472				
32"	3170	39-42 lbs	60-3170	40"	3940	24-30 lbs	60-394	48"	4730	19-24 lbs	60-473				
32"	3175	42-45 lbs	60-3175	40"	3950	30-35 lbs	60-3950	48"	4740	24-30 lbs	60-474				
33"	3210	8-13 lbs	60-321	40"	3960	35-39 lbs	60-3960	48"	4750	30-35 lbs	60-4750				
33"	3220	13-18 lbs	60-322	40"	3965	39-42 lbs	60-3965	48"	4760	35-39 lbs	60-4760				
33"	3230	18-23 lbs	60-323	40"	3970	42-45 lbs	60-3970	48"	4765	39-42 lbs	60-4765				
33"	3240	23-28 lbs	60-324	41"	4010	9-14 lbs	60-401	48"	4770	42-45 lbs	60-4770				
33"	3250	28-32 lbs	60-3250	41"	4020	14-19 lbs	60-402	49"	4810	9-14 lbs	60-481				
33"	3260	32-35 lbs	60-3260	41"	4030	19-23 lbs	60-403	49"	4820	14-19 lbs	60-482				
33"	3265	35-39 lbs	60-3265	41"	4040	23-30 lbs	60-404	49"	4830	19-24 lbs	60-483				
33"	3270	39-42 lbs	60-3270	41"	4050	30-35 lbs	60-4050	49"	4840	24-32 lbs	60-484				
33"	3275	42-45 lbs	60-3275	41"	4060	35-39 lbs	60-4060	49"	4850	30-35 lbs	60-4850				
34"	3310	8-13 lbs	60-331	41"	4065	39-42 lbs	60-4065	49"	4860	35-39 lbs	60-4860				
34"	3320	13-18 lbs	60-332	41"	4070	42-45 lbs	60-4070	49"	4865	39-42 lbs	60-4865				
34"	3330	18-23 lbs	60-333	42"	4110	9-14 lbs	60-411	49"	4870	42-45 lbs	60-4870				
34"	3340	23-28 lbs	60-334	42"	4120	14-19 lbs	60-412	50"	4910	9-14 lbs	60-491				
34"	3350	28-32 lbs	60-3350	42"	4130	19-24 lbs	60-413	50"	4920	14-19 lbs	60-492				
34"	3360	32-35 lbs	60-3360	42"	4140	24-30 lbs	60-414	50"	4930	19-24 lbs	60-493				
34"	3365	35-39 lbs	60-3365	42"	4150	30-35 lbs	60-4150	50"	4940	24-32 lbs	60-494				

# SASH SUPPORT SYSTEMS

## 60 SERIES BALANCE ACCESSORIES

### 60 SERIES MOST POPULAR COMBINATIONS

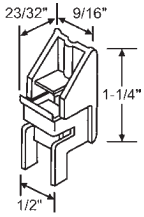

**60-507**  
Top

**Suffix -1**

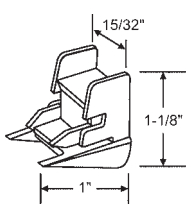

**60-501**  
Bottom

**SEASONSHIELD/ALECCO**

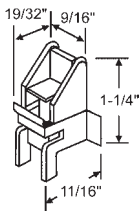

**60-508**  
Top

**Suffix -3**

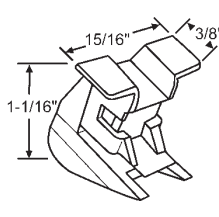

**60-503**  
Bottom

**CROSS EASTERN/PENCO/MILLER/REMINGTON**

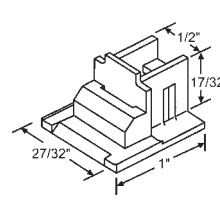

**60-595**  
Top

**Suffix -28**

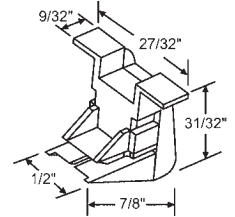

**60-596**  
Bottom

**PAN AM**

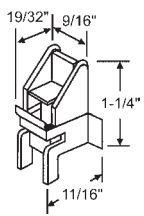

**60-508**  
Top

**Suffix -42**

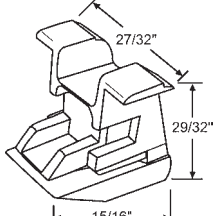

**60-5011**  
Bottom

**MILESTONE/FL EXTRUDERS**

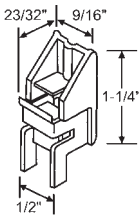

**60-507**  
Top

**Suffix -0**

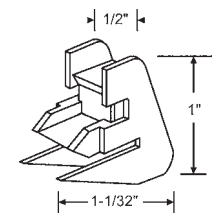

**60-500**  
Bottom

**OLD KINCO/HARCAN/NUAIR/SUNSHINE/EFCO**

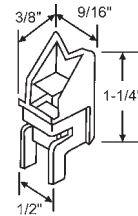

**60-936**  
Top

**Suffix -36**

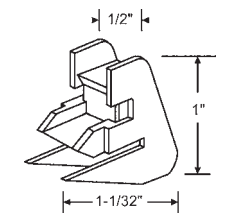

**60-500**  
Bottom

**YALE OGRON**

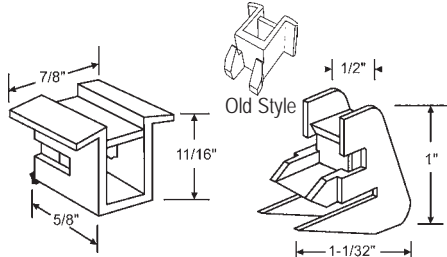

**60-506**  
Top

**Suffix -6**

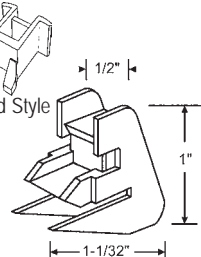

**60-500**  
Bottom

**CAPITOL**

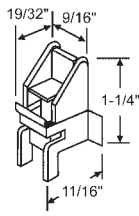

**60-508**  
Top

**Suffix -8**

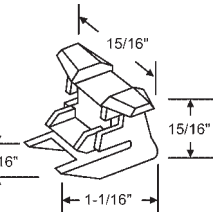

**60-516**  
Bottom

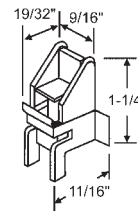

**60-508**  
Top

**Suffix -27**

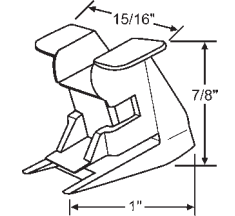

**60-943**  
Bottom

**ALCAN**

### 60 SERIES OTHER COMBINATIONS

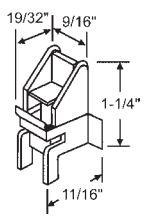

**60-508**  
Top

**Suffix -40**

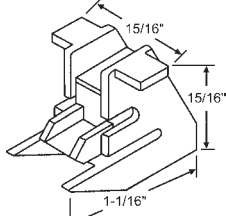

**60-904**  
Bottom

**NORANDEX**

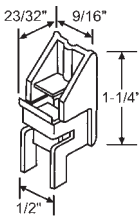

**60-507**  
Top

**Suffix -2**

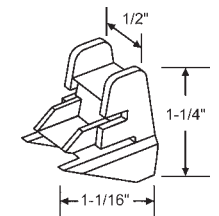

**60-502**  
Bottom

**CROSSLY 700 SERIES**

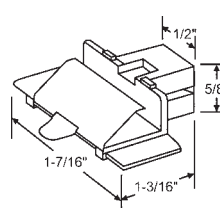

**60-510**  
Top

**Suffix -4**

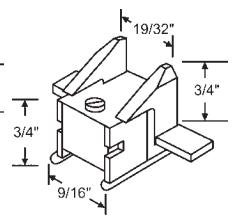

**60-504**  
Bottom

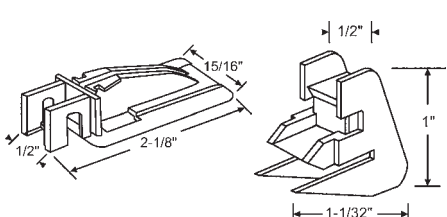

**60-509**  
Top

**Suffix -5**

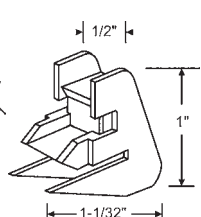

**60-500**  
Bottom

**WT INDUSTRIES (REPLACEMENT)**

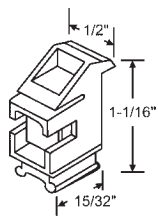

**60-560**  
Top

**Suffix -7**

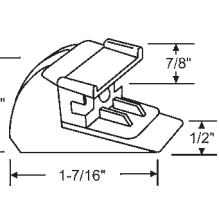

**60-561**  
Bottom

**ACORN**

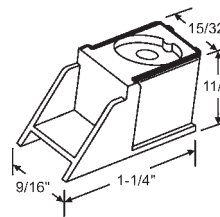

**60-907**  
Top

**Suffix -9**

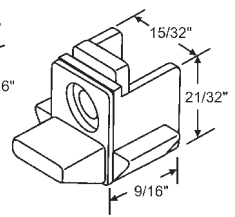

**60-908**  
Bottom

**AMERICAN CRAFTSMAN/SILVER LINE**



## 60 SERIES BALANCE ACCESSORIES

### 60 SERIES OTHER COMBINATIONS

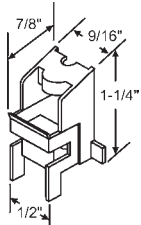

**60-916**  
Top

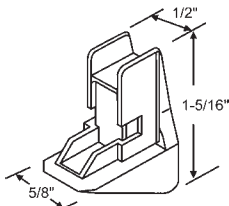

**60-915**  
Bottom

**CAPITOL/MILLER**

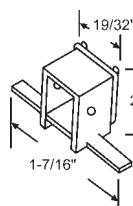

**60-569**  
Top

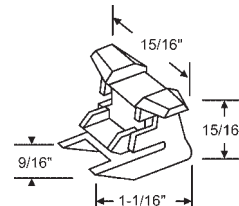

**Suffix -12**  
**60-516**  
Bottom

**ROLLYSON**

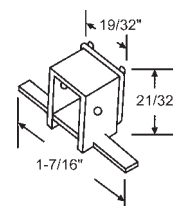

**60-569**  
Top

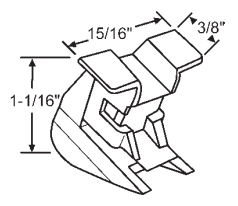

**Suffix -12R**  
**60-516**  
Bottom

**ROLLYSON**

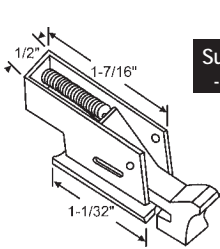

**60-513**  
Top

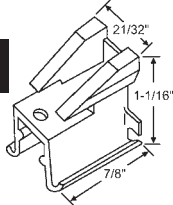

**60-505**

Bottom. Must be installed with screw 20-046 at time of installation.

**GTO 4 WINDOWS/GENERAL BRONZE**

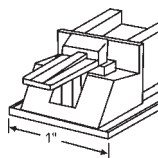

**60-575**  
Top

**Suffix -14**

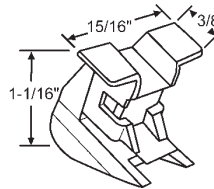

**60-503**  
Bottom

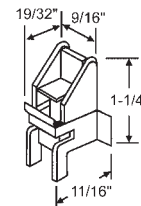

**60-508**  
Top

**Suffix -16**

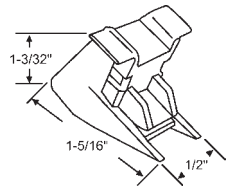

**60-598**  
Bottom

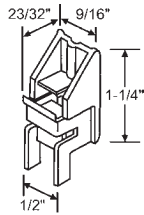

**60-507**  
Top

**Suffix -17**

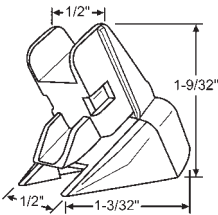

**60-597**  
Bottom

**ESP**

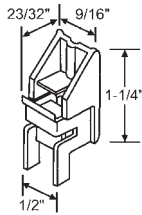

**60-507**  
Top

**Suffix -18**

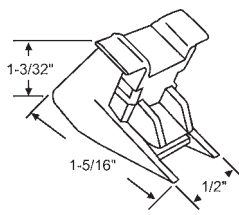

**60-598**  
Bottom

**FIBERLUX/BELLVIEW**

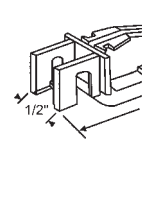

**60-509**  
Top

**Suffix -19**

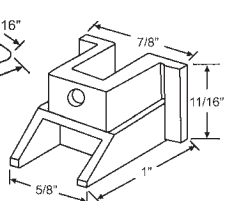

**60-576**  
Bottom

**WT INDUSTRIES (ORIGINAL VERSION)**

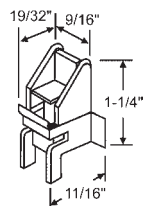

**60-508**  
Top

**Suffix -20**

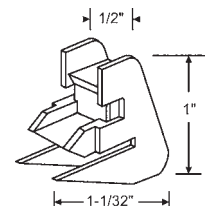

**60-500**  
Bottom

**CE ANDERSON/ALENCO/MILLER**

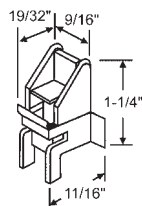

**60-508**  
Top

**Suffix -21**

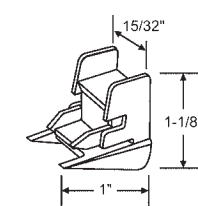

**60-501**  
Bottom

**PGT/VINYLTEC**

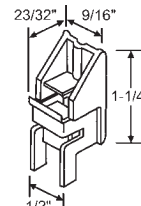

**60-507**  
Top

**Suffix -23**

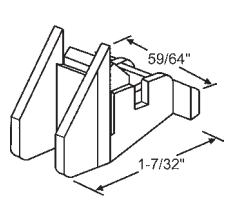

**60-987**  
Bottom

**ALCOA**

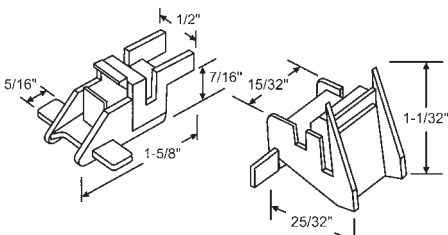

**60-901**  
Top

**Suffix -24**

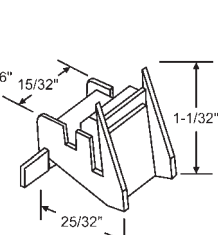

**60-902**  
Bottom

**CROSSLY 780 SERIES**

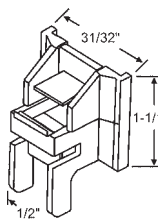

**900-10269**  
Top

**Suffix -25**

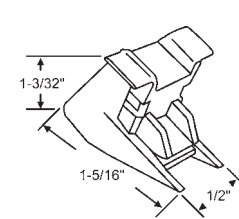

**60-598**  
Bottom

**BELLVIEW**

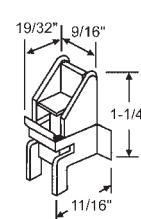

**60-508**  
Top

**Suffix -26**

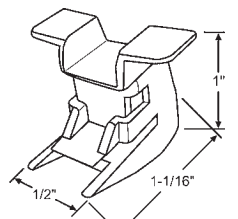

**60-980**  
Bottom

# SASH SUPPORT SYSTEMS

## 60 SERIES BALANCE ACCESSORIES

### 60 SERIES OTHER COMBINATIONS

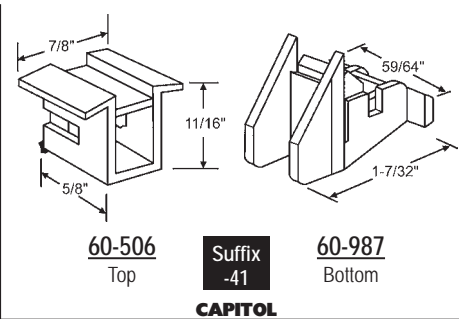
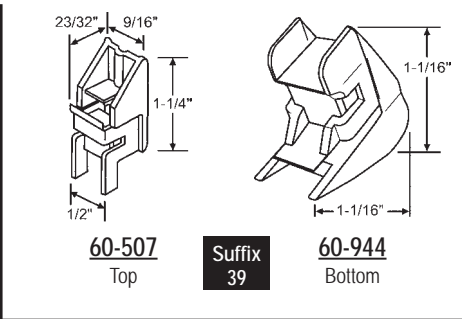
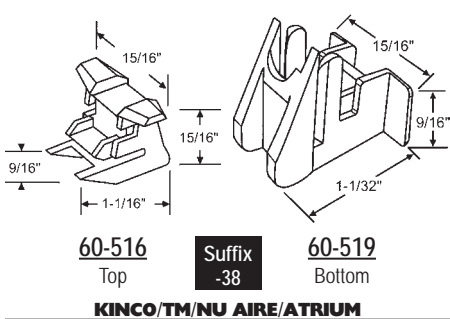
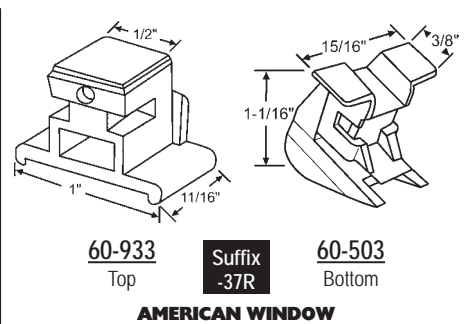
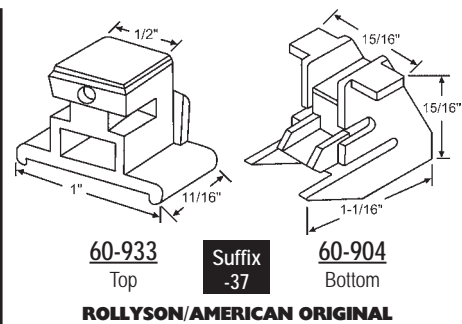
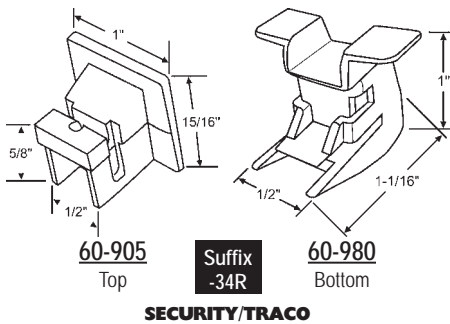
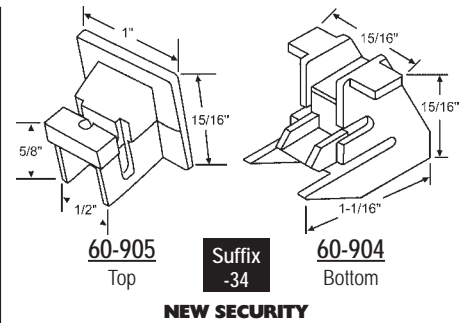
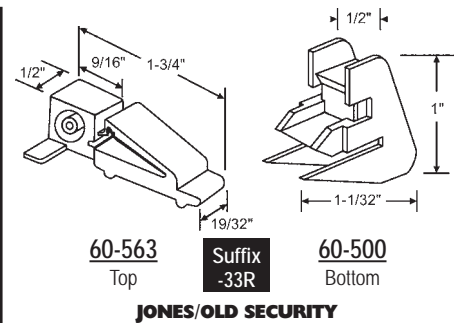
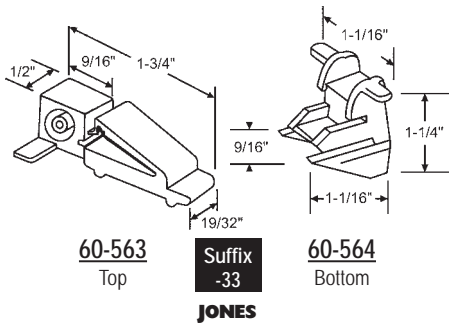
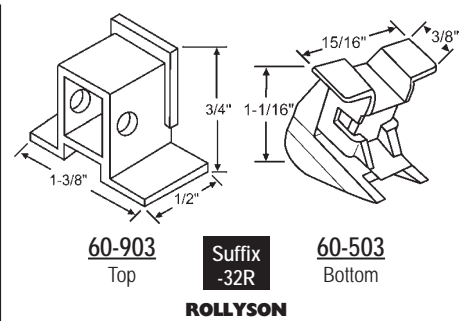
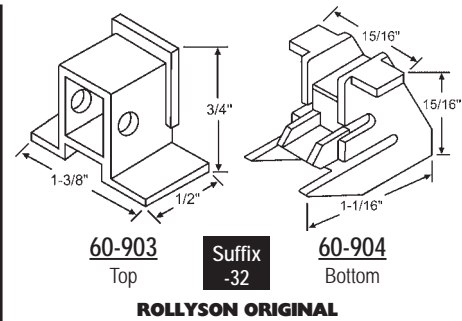
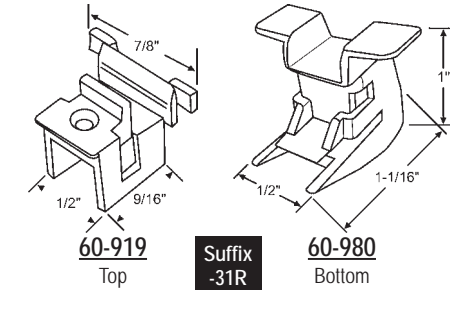
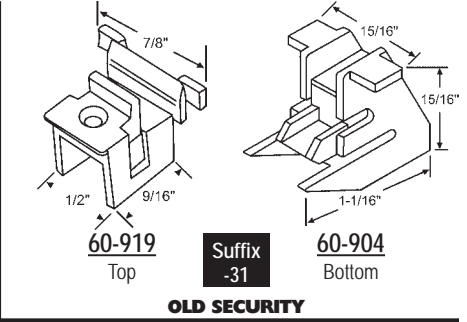
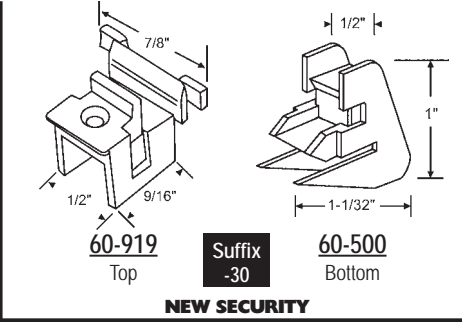
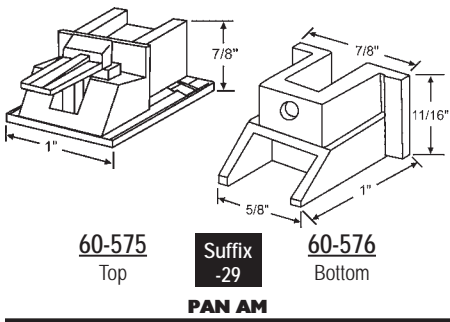

## 60 SERIES BALANCE ACCESSORIES

### 60 SERIES OTHER COMBINATIONS

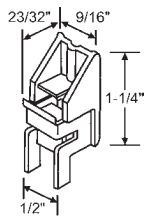

**60-507**  
Top

**Suffix -43**

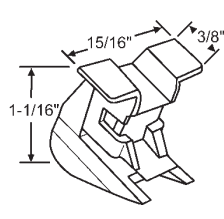

**60-503**  
Bottom

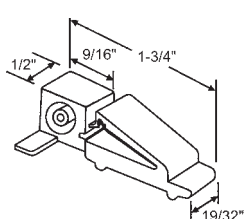

**60-563**  
Top

**Suffix -44**

**60-587**  
Bottom

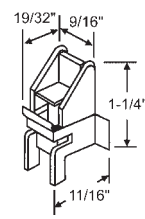
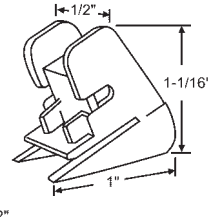

**60-508**  
Top

**Suffix -45**

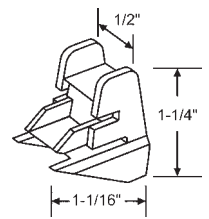

**60-502**  
Bottom

### TOP BRACKETS

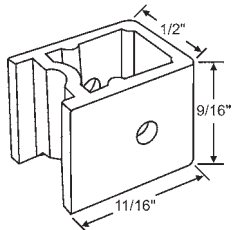

**60-568**  
**SWS**

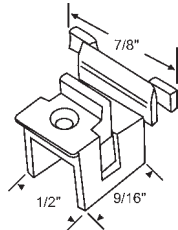

**60-919**  
**OLD SECURITY**

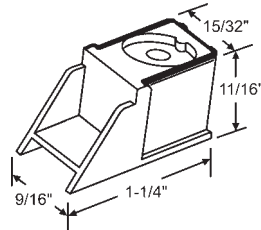

**60-907**  
**SILVERLINE**

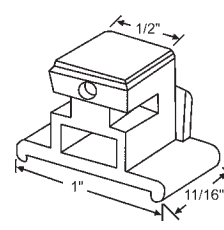

**60-933**

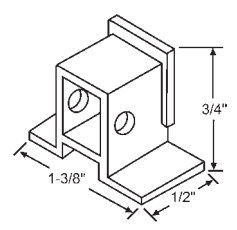

**60-903**  
**ROLLYSON**

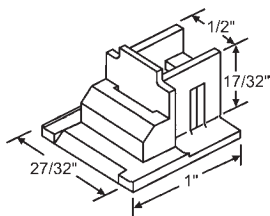

**60-595**  
**PAN AM**

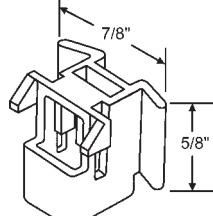

**60-591**  
**CAPITOL**

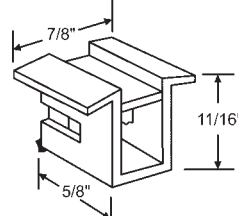

**60-506**  
**CAPITOL**

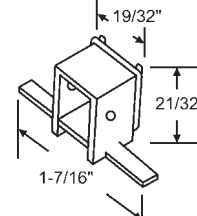

**60-569**  
**ROLLYSON**

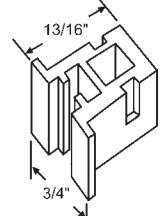

**900-15343**  
**WEATHERVANE**

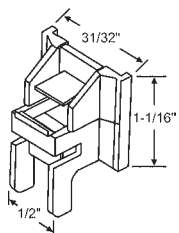

**900-10269**  
**BELLVIEW**

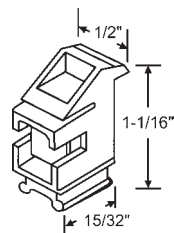

**60-560**  
**ACORN**

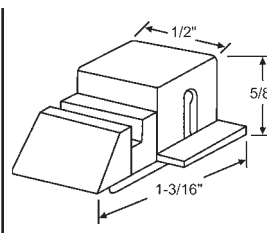

**60-578**  
**BELLHOUSE**

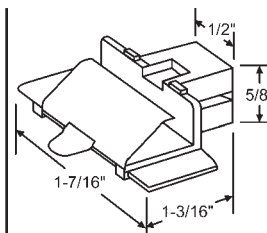

**60-510**  
**CROSSLY**

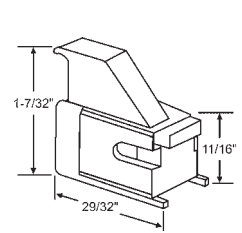

**60-511**  
**IDA**

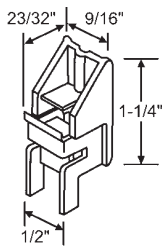

Part #	Color
60-507	White
60-507B	Black

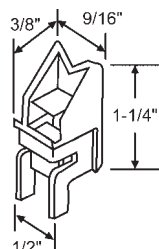

**60-936**  
**YALE OGRON**

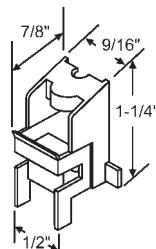

**60-916**  
**CAPITOL**

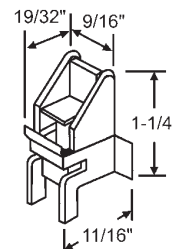

**60-508**

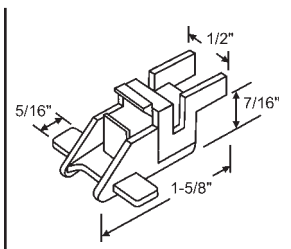

**60-901**  
**CROSSLY**

# SASH SUPPORT SYSTEMS

## 60 SERIES BALANCE ACCESSORIES

### TOP BRACKETS

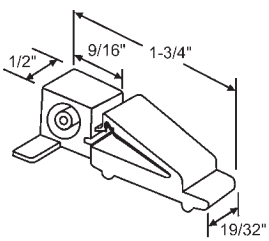

**60-563**  
**JONES**

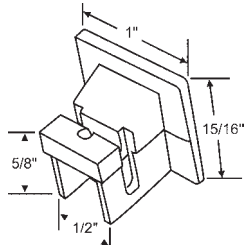

**60-905**  
**NEW SECURITY**

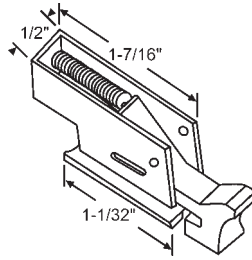

**60-513**  
**GENERAL BRONZE**

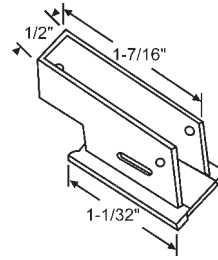

**60-513B**  
Body Only

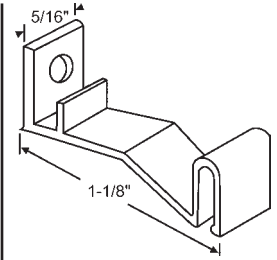

**60-592**  
Metal Toggle. Used with 60-513B

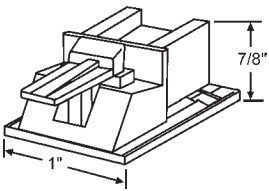

**60-575**  
**PAN AM**

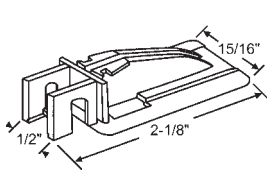

**60-509**  
**WT INDUSTRIES**

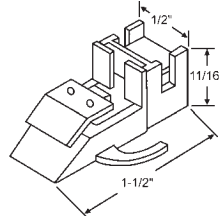

**60-583**  
**DARYL**

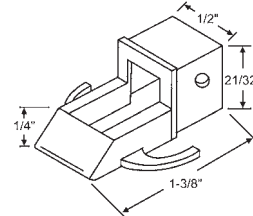

**60-586**  
**DARYL**

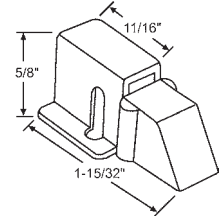

**60-562**  
**SWS**

### BOTTOM BRACKETS

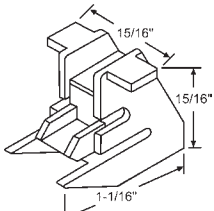

**60-904**  
**ROLLYSON**

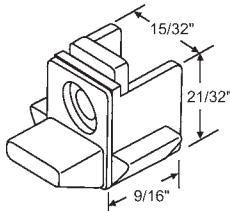

**60-908**  
**SILVERLINE**

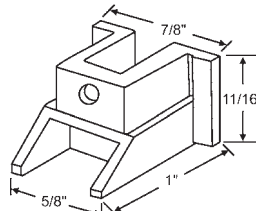

**60-576**  
**PAN AM**

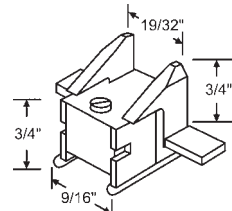

**60-504**  
**CROSSLY**

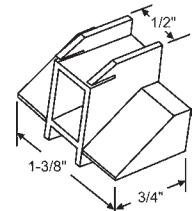

**900-15344**  
**WEATHERVANE**

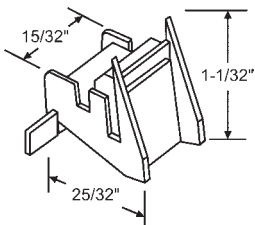

**60-902**  
**CROSSLY**

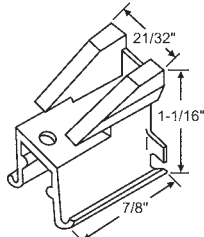

**60-505**  
Must be installed with screw  
20-046 at time of installation.  
**GENERAL BRONZE**

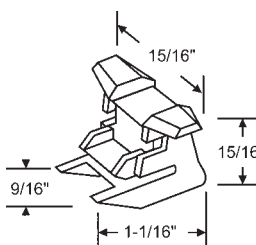

**60-516**  
**ROLLYSON**

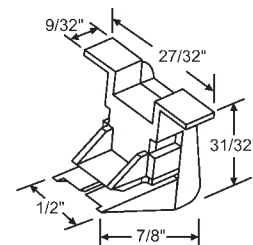

**60-596**  
**PAN AM**

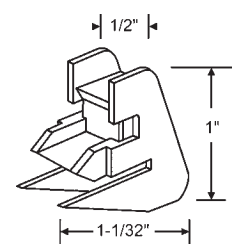

**60-500**  
**CAPITOL/WT INDUSTRIES**

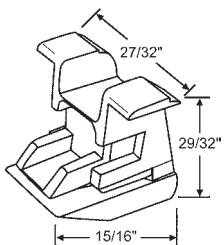

**60-5011**  
Nylon  
**UNIQUE**

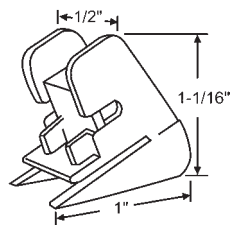

**60-587**  
**SEASONALL**

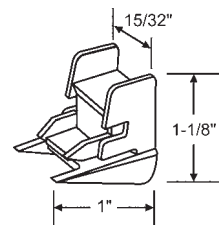

**60-501**  
**GENERAL BRONZE**

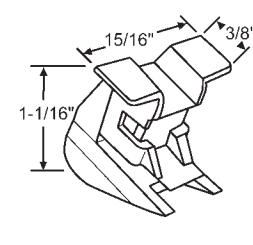

**60-503**

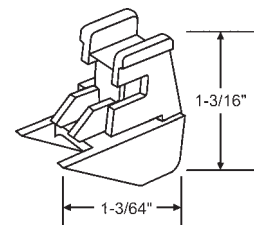

**60-590**  
**CAPITOL**

## 60 SERIES BALANCE ACCESSORIES

### BOTTOM BRACKETS

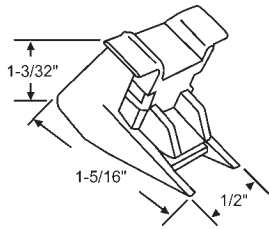

**60-598**  
**FIBERLUX**

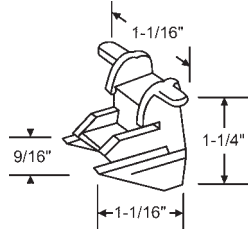

**60-564**  
**JONES**

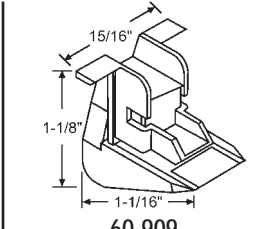

**60-909**  
No Longer Available. Use: 60-503  
**CAPITOL**

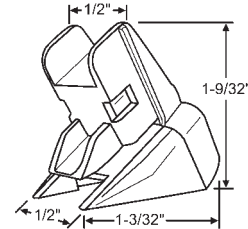

**60-597**

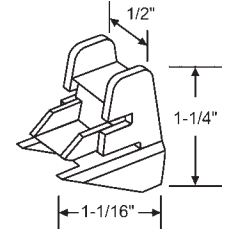

**60-502**  
**SEASONALL**

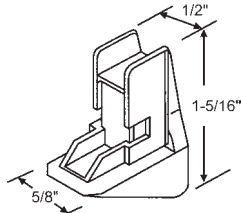

**60-915**  
**CAPITOL**

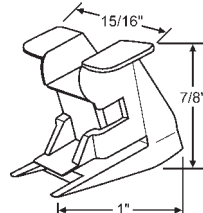

**60-943**  
Nylon  
**ALCAN**

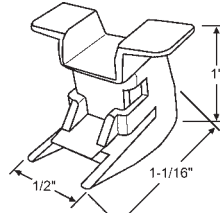

**60-980**  
Winged

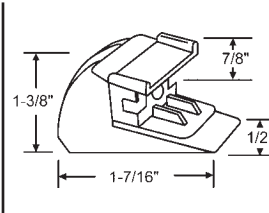

**60-561**  
**ACORN**

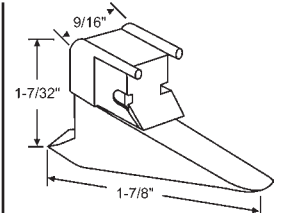

**60-512**  
**IDA**

### TERMINAL CLIP

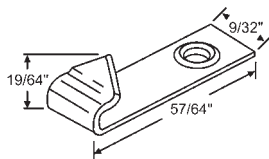

**60-518**

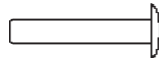

Part #	Description
60-514	3/32" Dia.
60-570	1/8" Dia., Heavy Duty

5/8" Length



**20-183**  
Rivet and Drive Screw Assy. Used when no rivet tool is available.

### PLASTIC TOP SASH GUIDES - In Order by Length

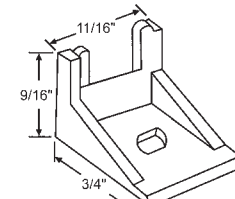

**60-616**  
**PAN AM**

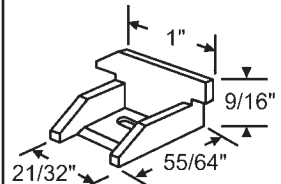

**60-619**  
LH & RH Set  
**PAN AM**

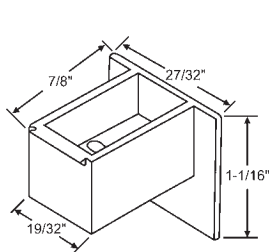

**60-632**  
**KING**

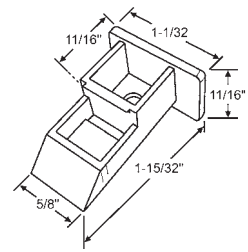

Part #	Color
60-957	Black
60-957W	White

LH & RH Set  
**YALE OGRON**

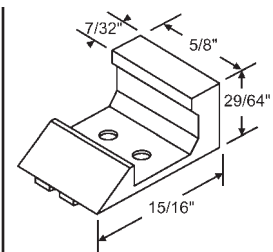

**60-640**  
Nylon  
**GENERAL ALUMINUM/PAN AM**

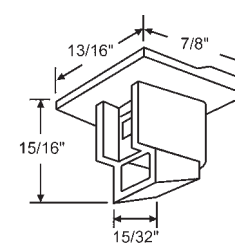

**60-600**  
**PENNCO**

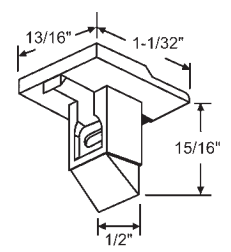

**60-601**  
**PENNCO**

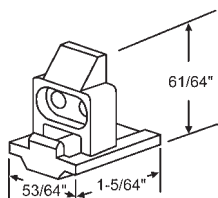

**60-630**  
**CAPITOL**

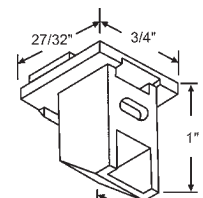

**60-621**

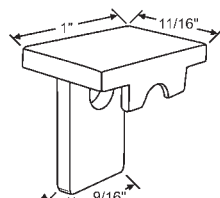

**900-9500P**  
White Nylon  
**SECURITY**

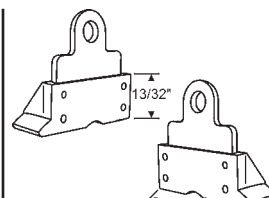

**60-620**  
Pair  
**CROSSLY**

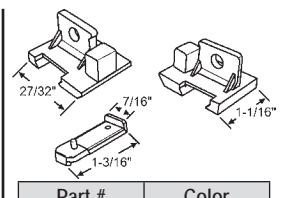

Part #	Color
900-5550A	Natural
900-5550BA	Black

Set  
**YALE OGRON**

# SASH SUPPORT SYSTEMS

## 60 SERIES BALANCE ACCESSORIES

### PLASTIC TOP SASH GUIDES - In Order by Length

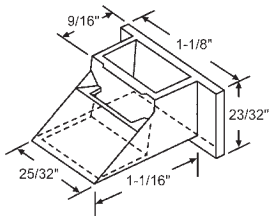

**60-629**

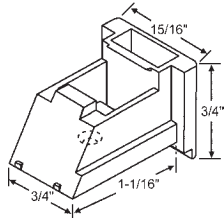

**900-14149BA**  
LH & RH Set, Black  
**BINNINGS**

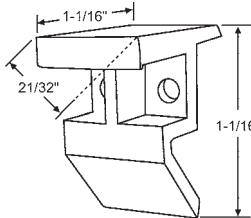

**60-672**  
White  
**CAPITOL**

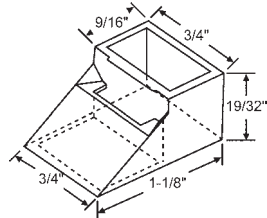

**60-643**

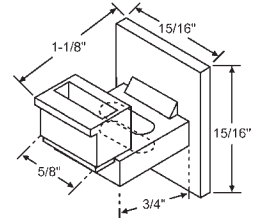

**900-18946**  
Black

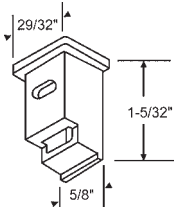

**60-733**  
Black  
**GALLATIN/GAPCO**

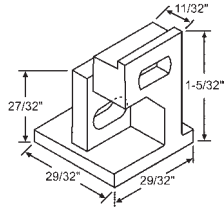

**900-6799A**  
LH & RH Set, White  
**GAPCO**

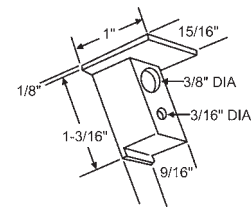

**60-727**  
Black  
**ALENCO**

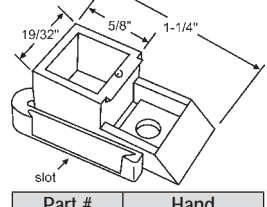

Part #	Hand
60-605	Shown
60-606	Opposite

Weatherstripping not included.  
**IDA**

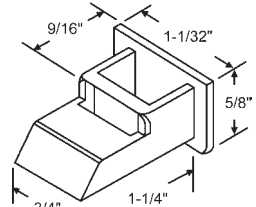

**60-645**

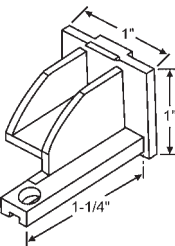

**60-676BA**  
LH & RH Set, Black

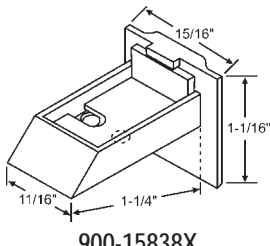

**900-15838X**  
Black Plastic  
**JORDAN**

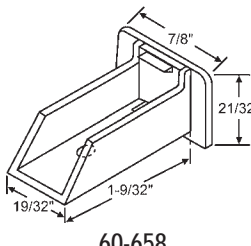

**60-658**  
**JORDAN**

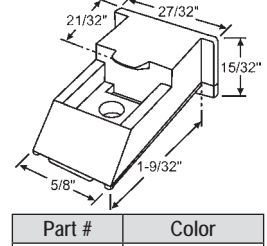

Part #	Color
900-20576	White
900-20576B	Black

**LAWSON**

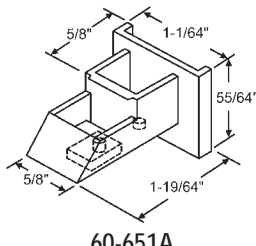

**60-651A**  
LH & RH Set  
**SUGAR CREEK**

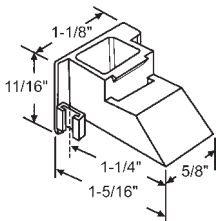

**900-9963**  
LH & RH Set

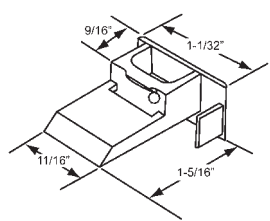

**60-732A**  
Nylon. Sold In Sets Only  
**NU-AIRE**

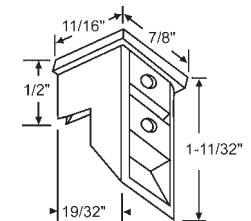

Part #	Color
60-602	White
60-602B	Black

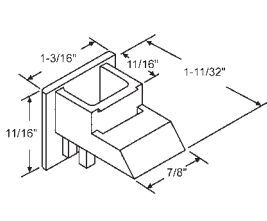

**900-13531A**  
LH & RH Set, Black  
**MANNIX**

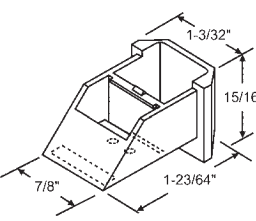

**60-661**  
Black

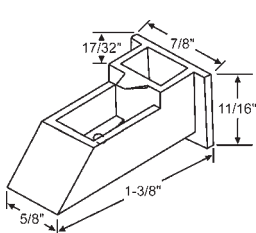

**900-10066**  
**KINCO**

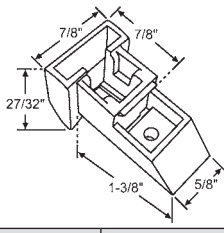

Part #	Color
60-935	White
60-935B	Black

**LAWSON**

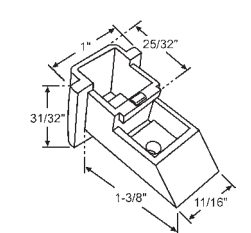

**900-10331**  
Black  
**MILLER**

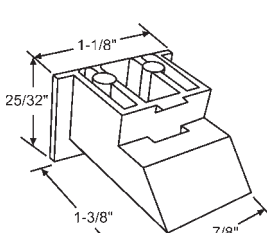

**60-958**  
Black Nylon

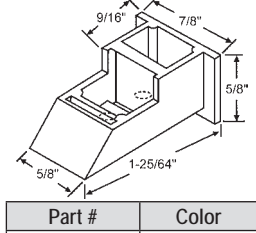

Part #	Color
60-6004	White
60-6004BG	Beige

**VBP / GENERAL ALUMINUM / BETTER BILT**

## 60 SERIES BALANCE ACCESSORIES

### PLASTIC TOP SASH GUIDES - In Order by Length

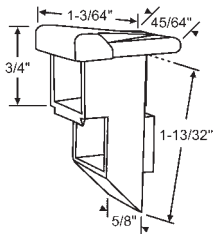

**60-624**  
White  
**GRAHAM**

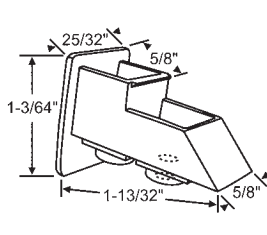

**60-653**  
**CROSSLY**

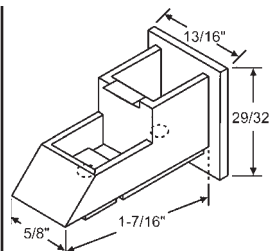

**900-13061**  
Black

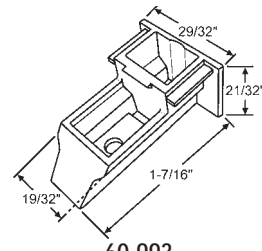

**60-993**  
Black  
**METAL INDUSTRIES**

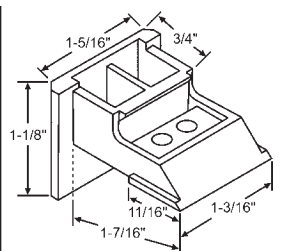

**900-15768**  
Black

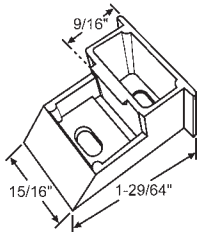

**60-963**  
Natural

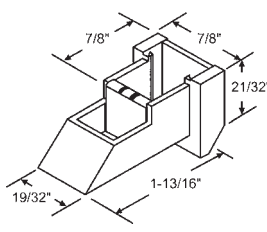

Old Style  
No Longer Available  
Use 60-654

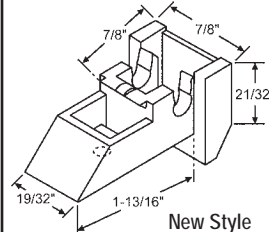

New Style  
**60-654**  
Old Style No Longer Available  
**SEASONALL**

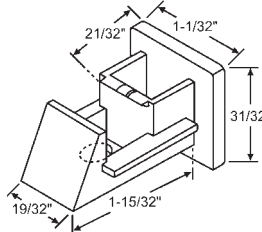

**60-641**  
**BINNINGS**

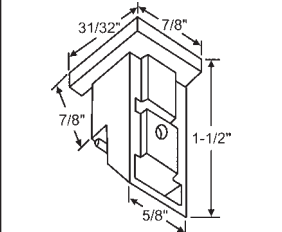

**900-1852**  
3/16" dia. hole. Hole center up  
17/32" from bottom.

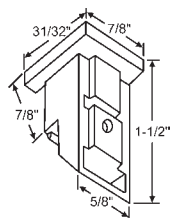

**60-612**  
Hole center  
up 9/16" from bottom.

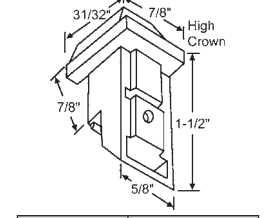

Part #	Color
60-613	Natural
60-613B	Black

Hole center up 9/16" from bottom.  
**CROSSLY**

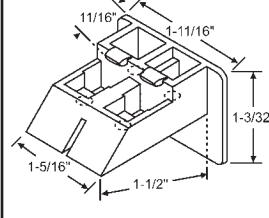

**900-19798**  
White

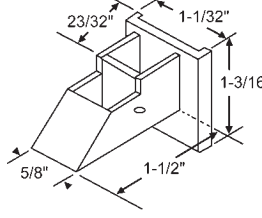

**60-652A**  
LH & RH Set  
**ALSCO/ANACONDA**

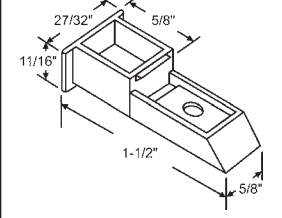

**60-618**  
White  
**SEASONALL**

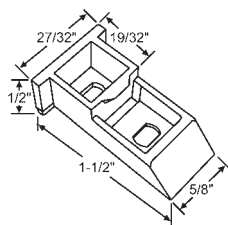

**900-10122**  
Natural  
**KINCO**

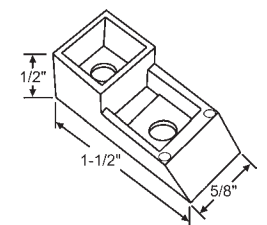

**900-10122-OS**  
Nylon  
**KINCO**

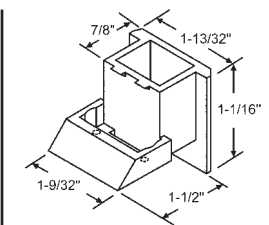

**60-646**  
Black  
**BINNINGS**

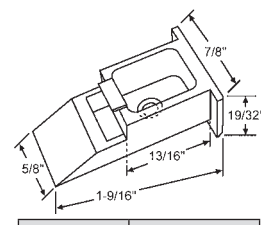

Part #	Color
900-16080	Black
900-16080W	White

**HARCAR**

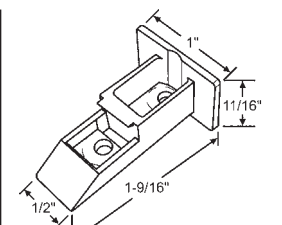

**60-971**  
White Nylon

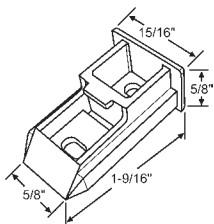

Part #	Color
60-633	Natural
60-633B	Black

**PGT 4000 SERIES**

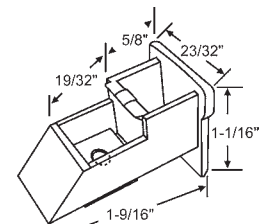

**60-604**  
**HOWMET**

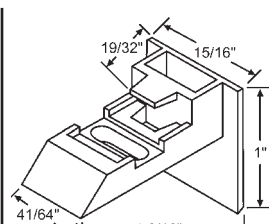

**60-675BL**  
Black  
**ROLLYSON**

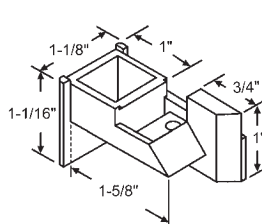

**60-666**  
LH & RH Set. Black  
**MANNIX**

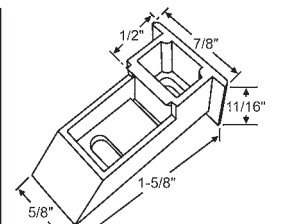

**900-1855**  
White Nylon

# SASH SUPPORT SYSTEMS

## 60 SERIES BALANCE ACCESSORIES

### PLASTIC TOP SASH GUIDES - In Order by Length

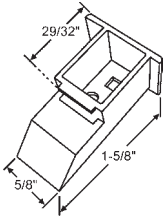

Part #	Hand
60-964LH	Shown
60-964RH	Opposite

White

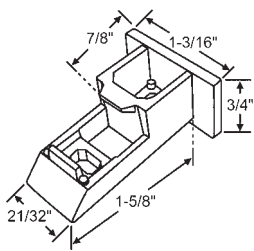

**60-962**  
White  
**LAWSON**

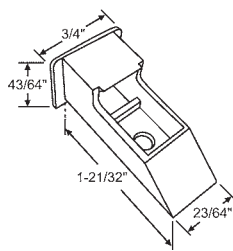

**900-20577**  
Nylon  
**SEASONSHIELD**

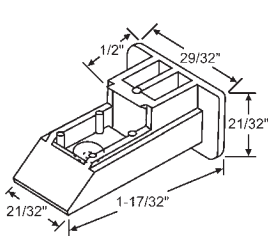

**900-11075**  
White  
**BELLVIEW**

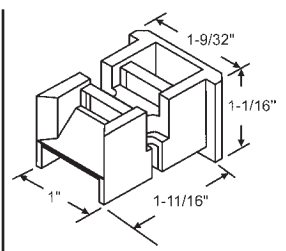

**60-648**  
Black  
**KAWNEER/WIDING**

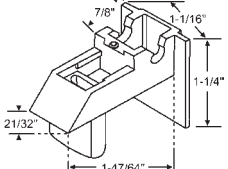

Part #	Color
60-657WH	White
60-657BL	Black
60-657BG	Beige
60-657BR	Brown

**FIBERLUX**

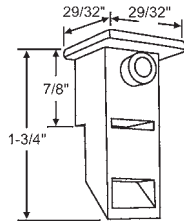

**60-622**  
**REYNOLDS**

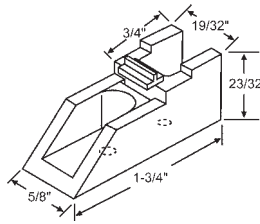

**60-647**  
White  
**MILCO**

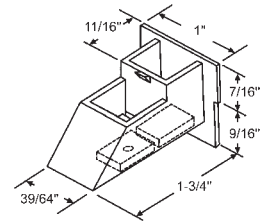

**60-659**  
White  
**KING**

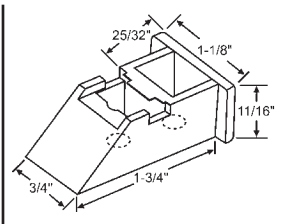

**60-642**

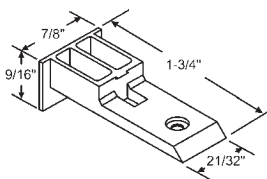

Part #	Color
900-18140W	White
900-18140B	Black

**NORANDEX**

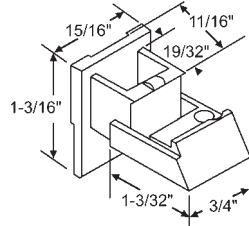

**900-1884A**  
LH & RH Set, Black  
**MANNIX**

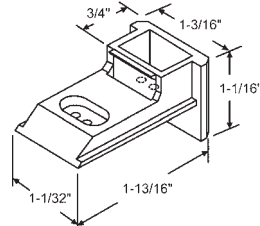

**60-644**  
Black  
**STORM WEATHER**

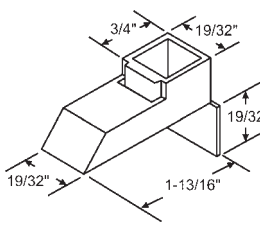

**60-656**  
Black  
**HOWARD**

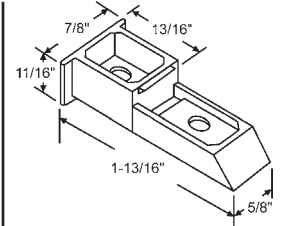

**60-617**  
White

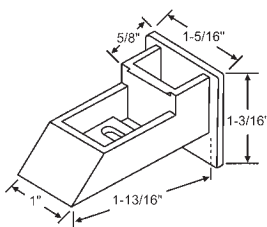

**900-14664**  
**SEASONALL**

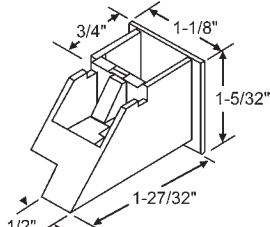

**60-649A**  
No Longer Available  
Use 60-649MODA

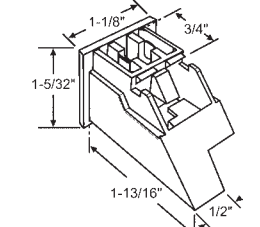

**60-649MODA**  
LH & RH Set, Black  
**THERMOTWIN**

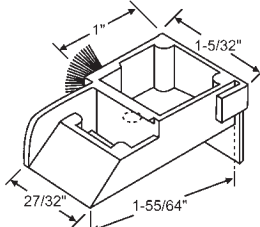

**900-16514A**  
LH & RH Set w/Weatherstrip, Black  
**ALENCO**

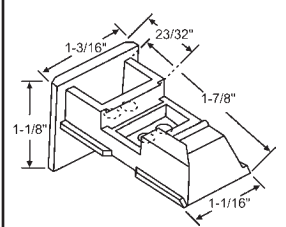

**900-15743BA**  
LH & RH Set, Black

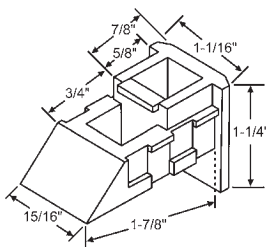

**60-660**  
Black

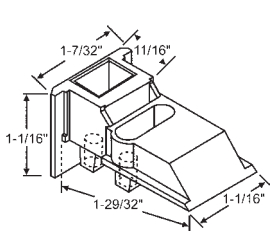

**900-15755BA**  
LH & RH Set, Black  
**STORM WEATHER**

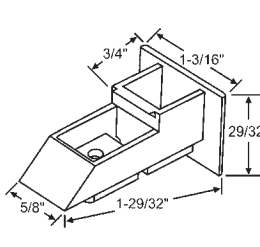

**900-11106**  
Black

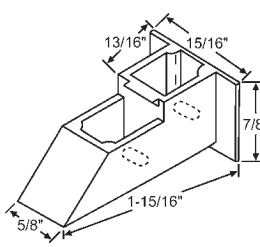

**900-16814**  
Black

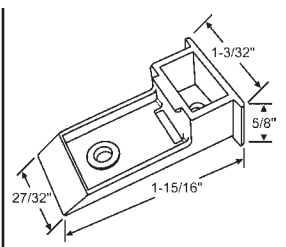

**60-6006**  
White Plastic



## 60 SERIES BALANCE ACCESSORIES

### PLASTIC TOP SASH GUIDES - In Order by Length

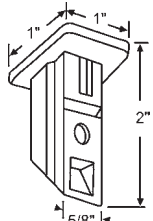

**60-582**  
White  
**SEASONALL**

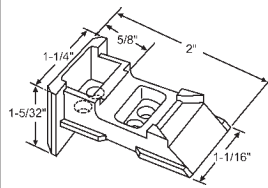

**60-941**  
Black  
**TRACO**

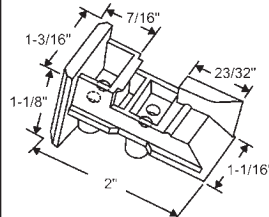

**900-15743BA**  
LH & RH Set  
Black

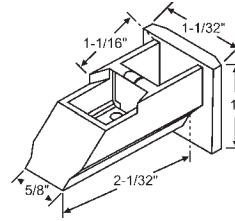

**900-15245**  
White (Original Color Gray)  
**AMACOR**

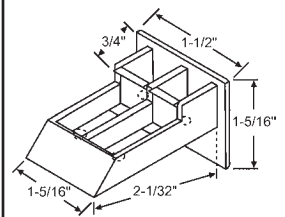

**900-12814**  
Black

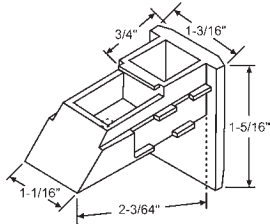

**60-650**  
Black

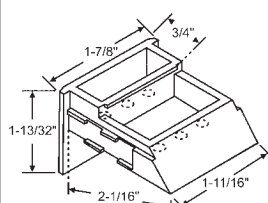

**900-15441B**  
Black

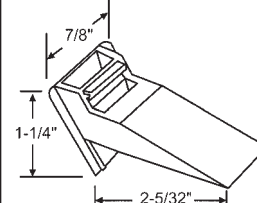

**60-610**  
Black  
**ACORN**

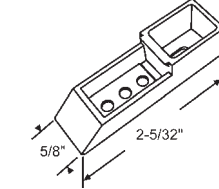

Part #	Color
60-603	White
60-603B	Black

**CLEARVIEW**

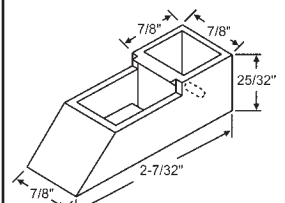

**900-14356**  
White

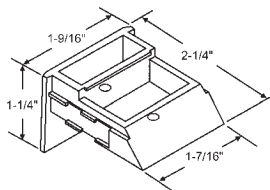

**900-1882B**  
Black

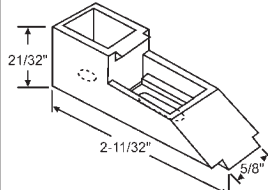

**60-623**  
Natural

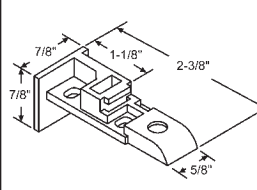

**60-684A**  
RH & LH Set. RH Shown  
White

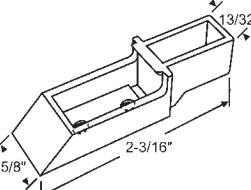

**60-668**  
**ALPINE**

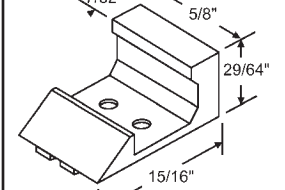

**60-640**  
Nylon  
**GENERAL**

### FACE GUIDE

### METAL SASH GUIDES

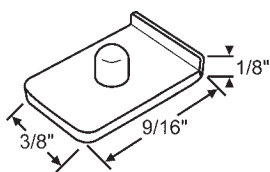

**2732P**  
**NU-AIR**

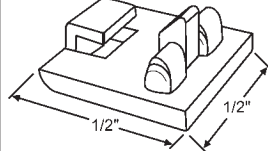

Part #	Color
900-19990	White
900-19990B	Black

Nylon Face Guide

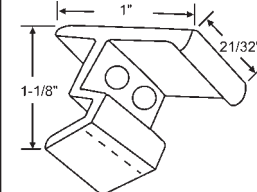

**900-14964-A**

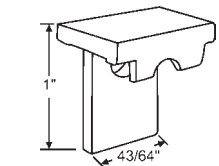

Part #	Color
900-9500AW	White
900-9500AB	Bronze
900-9500AL	Aluminum

Aluminum  
**SECURITY**

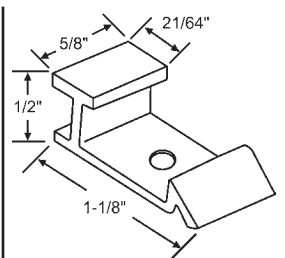

**60-609**  
**HOWARD**

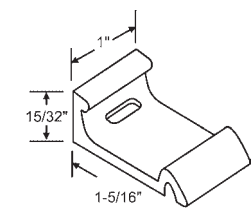

**60-665**  
**CROSSLY**

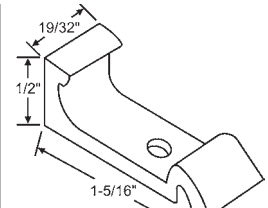

**60-611**

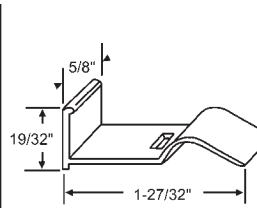

**60-663**  
**CAPITOL**

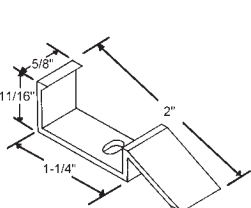

**900-10396**

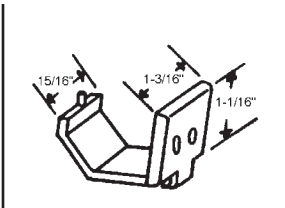

**900-9250**  
Bronze  
**CAPITOL**

# SASH SUPPORT SYSTEMS

## 60 SERIES BALANCE ACCESSORIES

### METAL SASH GUIDES

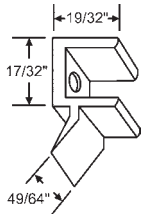

**60-608**  
CAPITOL

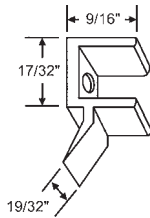

**60-607**  
CAPITOL

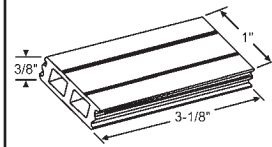

**60-705**  
White Rubber  
CAPITOL

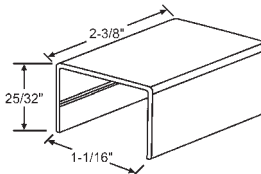

**60-6009WX**  
White  
PGT

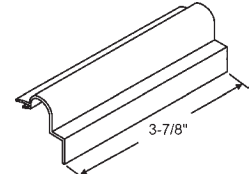

**900-18768**  
White  
SEASONALL

### SASH STOPS

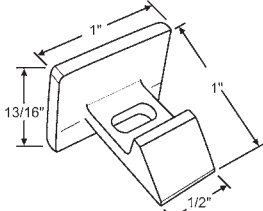

**60-721**  
Plastic

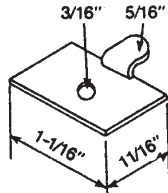

**900-16788**  
YALE OGRON

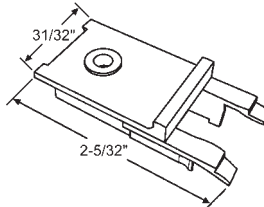

**900-9400**  
Black  
ACORN

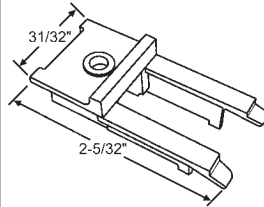

**900-9566**  
Black  
ACORN

### TAKE OUT CLIPS

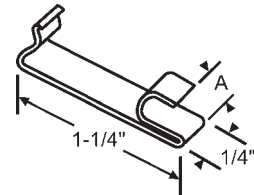

Part #	Description
60-700	A=1/4"
60-708	A=5/16"

### 60 SERIES MISCELLANEOUS

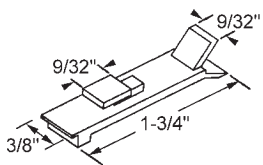

**60-662**  
Plastic  
PAN AM

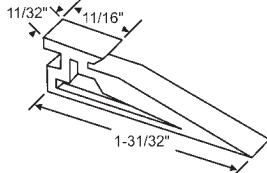

**60-701**  
Frame Guide  
IDA

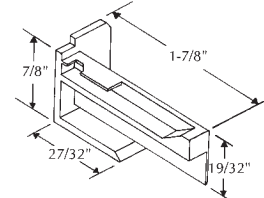

**900-14926WA**  
LH & RH Anti-Draft Plug Set. White  
SEASONALL

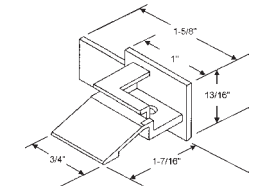

Part #	Color
60-673	White
60-673BL	Black

Vent Clip Sash Guides - Pair  
ROLLYSON

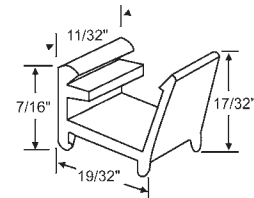

**60-515**  
Extender

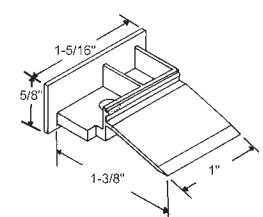

**60-674BA**  
Black Vent Clips - Pair  
ROLLYSON

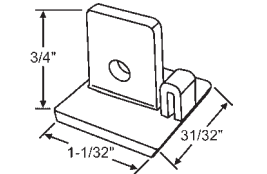

Part #	Color
60-664	White
60-664B	Black

Nylon Vent Bracket.  
YALE OGRON

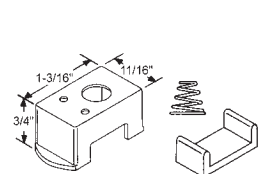

**60-906**  
3 Piece Balance Guide Assembly  
LOUISIANA PACIFIC

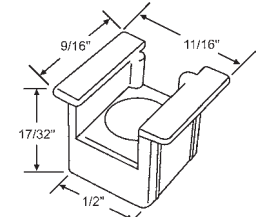

**60-614**  
Square Guide  
WT INDUSTRIES

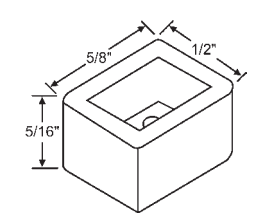

**900-13360**  
Black Face Guide  
SWS

### WINDOW BALANCE RIVET TOOLS

For Channel and Tube Balances "A Must for Repair and Assembly of Balance Brackets" (Tube & Channel)  
Professional Results! Say Good-bye to Hammered Fingers! FAST - EFFICIENT - COST EFFECTIVE

#### RIVET CRIMPING PLIERS

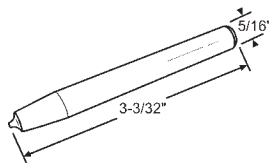

**59-81**  
Rivet Installation Tool

**59-1**  
Adjusts to accommodate both tube and channel balances.

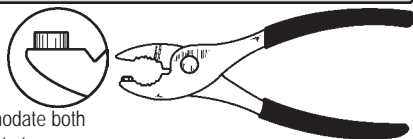

For tube balances, simply line up pin with peened rivet and squeeze. Rivet will be pushed out. For channel balances, grind or file rivet flush and then squeeze to remove rivet.

#### RIVET REMOVAL PLIERS

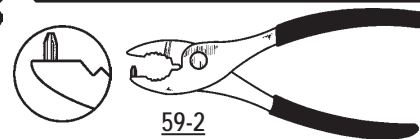

**59-2**



**59-3**

Replacement pin for rivet removal pliers

The Invisible Balance has been used for over 25 years, primarily for wood windows. They are an excellent choice for historic window renovations, eliminating exposed hardware and maintaining the original window appearance. This product is the favorite of the custom millwork industry when jambliner aesthetics are not acceptable.

### ORDERING INFORMATION:

- 1) Measure metal channel length.
- 2) Check number stamped on channel. (e.g. 101 or 101A or 101AX etc.)
- 3) Select our corresponding part numbers from the chart on following page and order accordingly.
- 4) Additional cord lengths are available: for 10" add "A" after part number, 5" add "B" and 8" add "C". Contact your account manager for other variations.

NOTE: If you have any unusual number/letter variations that are not shown in the chart, please consult your representative to be sure that your order will be filled correctly.

NOTE: With the 60A and 60AX series take out system, the sash balance becomes part of the sash. Therefore, when calculating sash weights, you must add the physical balance weight to the sash weights.

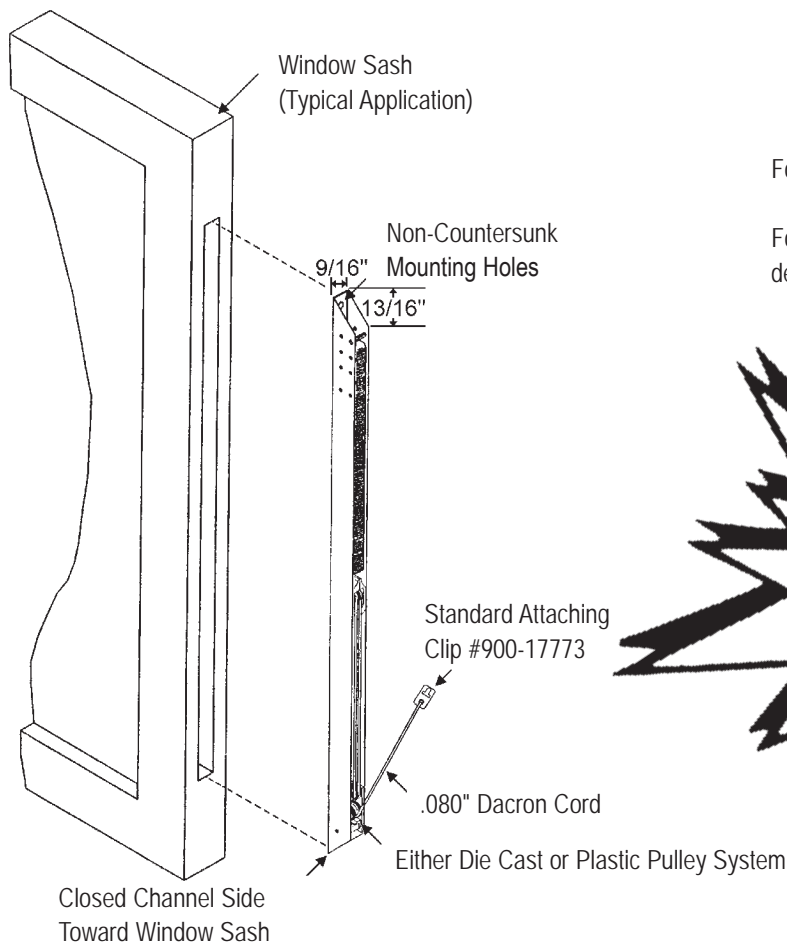

For "A" type balance make plough in sash 5/8" wide X 1" deep.

For "AX" type balance make plough in sash 5/8" wide X 1-1/8" deep to accommodate double spring.

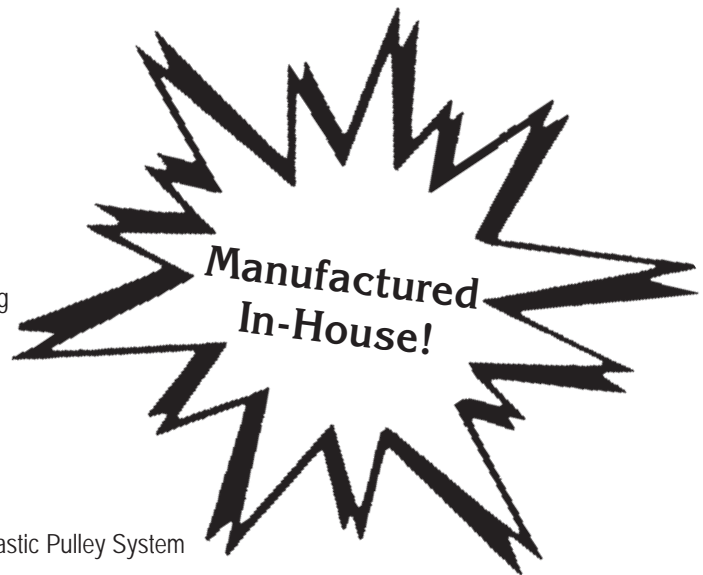

Refer to chart on following page.

### SERIES A/AX BALANCE INSTALLATION

- Both "A" and "AX" balances are designed to counterbalance certain weights, regardless of the thickness of the sash. Do not overload.
- For odd height glass use the next smaller balance.
- When ploughing for over 36" glass height start at bottom of each sash, as always, and make groove the same length as you do for 36" glass leaving extra wood at top of stiles.

# SASH SUPPORT SYSTEMS

## 60A AND 60AX SERIES - THE INVISIBLE BALANCE

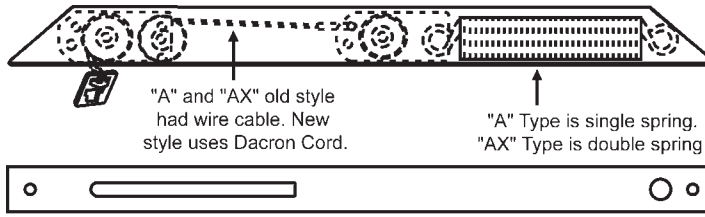
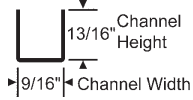

Old style is slotted;  
new style is not.



Bottom View

### End Brackets

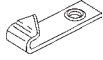

900-17773

60-518HD

900-21263

(Preferred) Brass Fitting with  
Round Screw Hole

### Attaching Clip

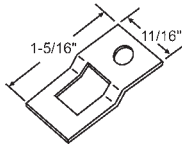

60-704M

### Example Ordering Chart

Length of Metal Channel	Number Stamped on Balance	Our Part Number	End Bracket	Cord Length	Complete Part Number
13-1/2"	101	60-A101	Standard	Standard	60-A101
13-1/2"	101	60-A101	1	Standard	60-A101-1
13-1/2"	101	60-A101	10	Standard	60-A101-10
13-1/2"	101	60-A101	10	+ 10"	60-A101-10A
13-1/2"	101	60-A101	10	+ 5"	60-A101-10B
13-1/2"	101	60-A101	10	+ 8"	60-A101-10C

Standard

-1

-10

### "A" TYPE (Single Spring)

Glass Height	Length of Metal Channel	Balance Number	Sash Weight Per Pair	Standard Cord Length	Our Part Number
12"	13-1/2"	101	5-7 lbs.	31"	60-A101
12"	13-1/2"	102	7-11 lbs.	31"	60-A102
14"	15-1/2"	111	5-8 lbs.	33"	60-A111
14"	15-1/2"	112	8-11 lbs.	33"	60-A112
16"	17-1/2"	121	5-9 lbs.	35"	60-A121
16"	17-1/2"	122	9-12 lbs.	35"	60-A122
18"	19-1/2"	131	5-9 lbs.	37"	60-A131
18"	19-1/2"	132	9-13 lbs.	37"	60-A132
20"	21-1/2"	141	5-9 lbs.	39"	60-A141
20"	21-1/2"	142	9-12 lbs.	39"	60-A142
20"	21-1/2"	143	12-14 lbs.	39"	60-A143
22"	23-1/2"	151	6-10 lbs.	41"	60-A151
22"	23-1/2"	152	10-12 lbs.	41"	60-A152
22"	23-1/2"	153	12-15 lbs.	41"	60-A153
24"	25-1/2"	161	6-10 lbs.	43"	60-A161
24"	25-1/2"	162	10-14 lbs.	43"	60-A162
24"	25-1/2"	163	14-18 lbs.	43"	60-A163
26"	27-1/2"	171	6-10 lbs.	45"	60-A171
26"	27-1/2"	172	10-14 lbs.	45"	60-A172
26"	27-1/2"	173	14-18 lbs.	45"	60-A173
28"	29-1/2"	181	7-12 lbs.	47"	60-A181
28"	29-1/2"	182	12-16 lbs.	47"	60-A182
28"	29-1/2"	183	16-20 lbs.	47"	60-A183
30"	31-1/2"	191	7-12 lbs.	49"	60-A191
30"	31-1/2"	192	12-16 lbs.	49"	60-A192
30"	31-1/2"	193	16-20 lbs.	49"	60-A193
32"	33-1/2"	201	8-14 lbs.	51"	60-A201
32"	33-1/2"	202	14-18 lbs.	51"	60-A202
32"	33-1/2"	203	18-22 lbs.	51"	60-A203
34"	35-1/2"	211	8-14 lbs.	53"	60-A211
34"	35-1/2"	212	14-18 lbs.	53"	60-A212
34"	35-1/2"	213	18-22 lbs.	53"	60-A213
36"	37-1/2"	221	8-15 lbs.	53"	60-A221
36"	37-1/2"	222	15-20 lbs.	55"	60-A222
36"	37-1/2"	223	20-24 lbs.	55"	60-A223
38"	37-1/2"	231	8-15 lbs.	57"	60-A231
38"	37-1/2"	232	15-20 lbs.	57"	60-A232
38"	37-1/2"	233	20-24 lbs.	57"	60-A233
40"	37-1/2"	241	8-15 lbs.	59"	60-A241
40"	37-1/2"	242	15-20 lbs.	59"	60-A242
40"	37-1/2"	243	20-24 lbs.	59"	60-A243
42"	37-1/2"	251	8-15 lbs.	61"	60-A251
42"	37-1/2"	252	15-20 lbs.	61"	60-A252
42"	37-1/2"	253	20-24 lbs.	61"	60-A253

NOTE: Whenever you add cord length to standard length you reduce the sash weight capacity and forfeit the warranty.

NOTE: Numbers stamped on balances may be the same -single spring designated by "A" -double spring designated by "AX".

NOTE: When determining sash weight, you need to include the weight of the balances. (e.g. Sash weighs 20 lbs. (2) balances weigh 3 lbs. Total sash weight is 23 lbs.)

### "AX" TYPE (Double Spring)

Glass Height	Length of Metal Channel	Balance Number	Sash Weight Per Pair	Standard Cord Length	Our Part Number
12"	13-1/2"	101AX	11-16 lbs.	31"	60-AX101
12"	13-1/2"	102AX	16-24 lbs.	31"	60-AX102
14"	15-1/2"	111AX	11-16 lbs.	33"	60-AX111
14"	15-1/2"	112AX	16-25 lbs.	33"	60-AX112
16"	17-1/2"	121AX	12-19 lbs.	35"	60-AX121
16"	17-1/2"	122AX	19-26 lbs.	35"	60-AX122
18"	19-1/2"	131AX	13-19 lbs.	37"	60-AX131
18"	19-1/2"	132AX	19-26 lbs.	37"	60-AX132
20"	21-1/2"	141AX	14-20 lbs.	39"	60-AX141
20"	21-1/2"	142AX	20-26 lbs.	39"	60-AX142
20"	21-1/2"	143AX	26-30 lbs.	39"	60-AX143
22"	23-1/2"	151AX	15-20 lbs.	41"	60-AX151
22"	23-1/2"	152AX	20-26 lbs.	41"	60-AX152
22"	23-1/2"	153AX	26-32 lbs.	41"	60-AX153
24"	25-1/2"	161AX	18-23 lbs.	43"	60-AX161
24"	25-1/2"	162AX	23-28 lbs.	43"	60-AX162
24"	25-1/2"	163AX	28-34 lbs.	43"	60-AX163
24"	25-1/2"	164AX	34-38 lbs.	43"	60-AX164
26"	27-1/2"	171AX	18-23 lbs.	45"	60-AX171
26"	27-1/2"	172AX	23-28 lbs.	45"	60-AX172
26"	27-1/2"	173AX	28-34 lbs.	45"	60-AX173
26"	27-1/2"	174AX	34-38 lbs.	45"	60-AX174
28"	29-1/2"	181AX	20-25 lbs.	47"	60-AX181
28"	29-1/2"	182AX	25-32 lbs.	47"	60-AX182
28"	29-1/2"	183AX	32-38 lbs.	47"	60-AX183
28"	29-1/2"	184AX	38-42 lbs.	47"	60-AX184
30"	31-1/2"	191AX	20-25 lbs.	49"	60-AX191
30"	31-1/2"	192AX	25-32 lbs.	49"	60-AX192
30"	31-1/2"	193AX	32-38 lbs.	49"	60-AX193
30"	31-1/2"	194AX	38-42 lbs.	49"	60-AX194
32"	33-1/2"	201AX	22-28 lbs.	51"	60-AX201
32"	33-1/2"	202AX	28-34 lbs.	51"	60-AX202
32"	33-1/2"	203AX	34-40 lbs.	51"	60-AX203
32"	33-1/2"	204AX	40-44 lbs.	51"	60-AX204
34"	35-1/2"	211AX	22-28 lbs.	53"	60-AX211
34"	35-1/2"	212AX	28-34 lbs.	53"	60-AX212
34"	35-1/2"	213AX	34-40 lbs.	53"	60-AX213
34"	35-1/2"	214AX	40-44 lbs.	53"	60-AX214
36"	37-1/2"	221AX	24-30 lbs.	55"	60-AX221
36"	37-1/2"	222AX	30-36 lbs.	55"	60-AX222
36"	37-1/2"	223AX	36-42 lbs.	55"	60-AX223
36"	37-1/2"	224AX	42-48 lbs.	55"	60-AX224
38"	37-1/2"	231AX	24-30 lbs.	57"	60-AX231
38"	37-1/2"	232AX	30-36 lbs.	57"	60-AX232
38"	37-1/2"	233AX	36-42 lbs.	57"	60-AX233
38"	37-1/2"	234AX	42-48 lbs.	57"	60-AX234
40"	37-1/2"	241AX	24-30 lbs.	59"	60-AX241
40"	37-1/2"	242AX	30-36 lbs.	59"	60-AX242
40"	37-1/2"	243AX	36-42 lbs.	59"	60-AX243
40"	37-1/2"	244AX	42-48 lbs.	59"	60-AX244
42"	37-1/2"	251AX	24-30 lbs.	61"	60-AX251
42"	37-1/2"	252AX	30-36 lbs.	61"	60-AX252
42"	37-1/2"	253AX	36-42 lbs.	61"	60-AX253
42"	37-1/2"	254AX	42-48 lbs.	61"	60-AX254

## 60P SERIES 1/2" CHANNEL BALANCE (PEACHTREE -ARIEL NON-TILT )

ACTUALLY 5/8" BUT CONSIDERED 1/2" IN THE TRADE

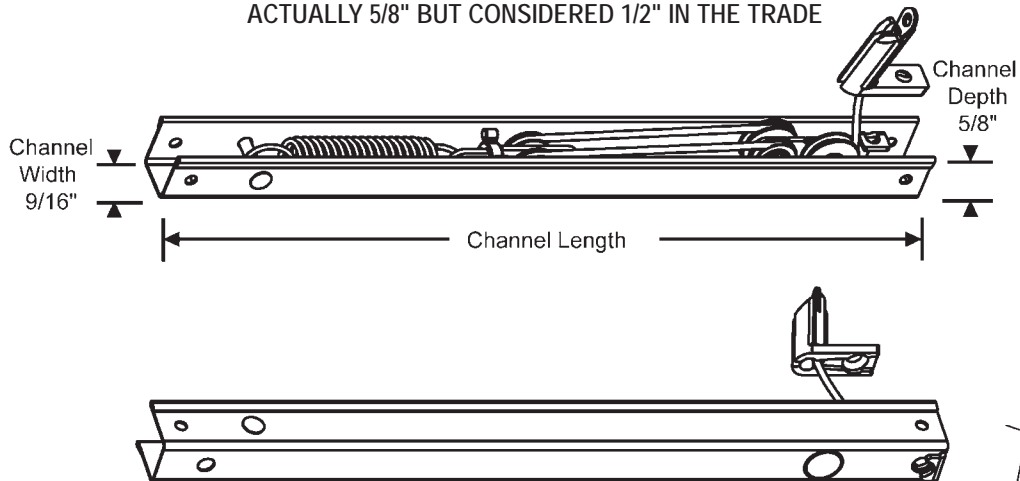

### Ordering Information

- 1) Measure metal channel length.
- 2) Identify number stamped on channel.
- 3) Select our corresponding part number from the chart below.

**Note:** Balances measuring 29-1/4" long are no longer manufactured. We recommend using the 32-1/4" balance. See chart below for weight ranges and select corresponding part number.

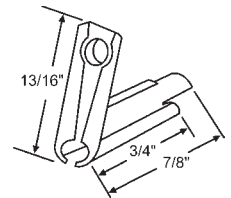

**60P-500**  
Black  
Balance Terminal Plug  
**PEACHTREE**

Peachtree Window Size	Our Part Number	Length of Metal Channel	Number Stamped on Balance	Weight Capacity
D2436	60P-134	14-1/4"	13-1/4 - 4	10 to 12
D2440	60P-154	16-1/4"	15-1/4 - 4	11 to 13
D2448	60P-194	20-1/4"	19-1/4 - 4	13 to 17
D2454	60P-223	23-1/4"	22-1/4 - 3	13 to 19
D2460	60P-253	26-1/4"	25-1/4 - 3	16 to 19
D2472	60P-313	32-1/4"	31-1/4 - 3	17 to 23
D3036	60P-134	14-1/4"	13-1/4 - 4	10 to 12
D3040	60P-154	16-1/4"	15-1/4 - 4	11 to 13
D3048	60P-194	20-1/4"	19-1/4 - 4	13 to 17
D3054	60P-223	23-1/4"	22-1/4 - 3	13 to 19
D3060	60P-253	26-1/4"	25-1/4 - 3	16 to 19
D3072	60P-314	32-1/4"	31-1/4 - 4	24 to 28
D3636	60P-135	14-1/4"	13-1/4 - 5	13 to 17
D3640	60P-155	16-1/4"	15-1/4 - 5	14 to 17
D3648	60P-194	20-1/4"	19-1/4 - 4	13 to 17
D3654	60P-224	23-1/4"	22-1/4 - 4	20 to 23
D3660	60P-254	26-1/4"	25-1/4 - 4	20 to 25
D3672	60P-314	32-1/4"	31-1/4 - 4	24 to 28
D4236	60P-135	14-1/4"	13-1/4 - 5	13 to 17
D4240	60P-156	16-1/4"	15-1/4 - 6	18 to 22
D4248	60P-199	20-1/4"	19-1/4 - 9	22 to 26
D4254	60P-224	23-1/4"	22-1/4 - 4	20 to 23
D4254	60P-229	23-1/4"	22-1/4 - 9	28 to 30
D4260	60P-254	26-1/4"	25-1/4 - 4	20 to 25
D4260	60P-255	26-1/4"	25-1/4 - 5	26 to 31
D4272	60P-315	32-1/4"	31-1/4 - 5	29 to 32
D4272	60P-316	32-1/4"	31-1/4 - 6	33 to 35
D4272	60P-319	32-1/4"	31-1/4 - 9	36 to 38

Actual size is 1" more than stamp on balances.

# SASH SUPPORT SYSTEMS

## 60G SERIES CHANNEL BALANCE (HURD MILWORK / THERMAL WINDOWS)



### INSTRUCTIONS

1. Measure metal channel length (do not include plastic ends, metal channel only)
2. Check number stamped on balance (e.g.: 24-1, 36-3, etc.)
3. Select our corresponding part number from chart below
4. Select your ends and clip combination from the list and add suffix to end of part number you choose from chart.

\*Note: When ordering balances where the number stamped on balance ends with DS (example 21DS) you need to specify the exact sash weight within the range listed on the chart.

Ordering Example: Number stamped on balance is 21DS, exact sash weight is 34 lbs. and the end clip combination is -1, you would then order part number 60G-21DS34

### Example Ordering Chart

Length of Metal Channel	Number Stamped on Balance	Our Part Number	End Clip Combination	Complete Part Number
24-5/8"	24-3	60G-243	-1	60G-243-1

Length of Metal Channel	Number Stamped on Balance	Sash Weight	Our Part Number	Length of Metal Channel	Number Stamped on Balance	Sash Weight	Our Part Number	Length of Metal Channel	Number Stamped on Balance	Sash Weight	Our Part Number	Length of Metal Channel	Number Stamped on Balance	Sash Weight	Our Part Number
12-5/8"	12-1	3-6	60G-121	19-5/8"	19-3	11-15	60G-193	26-5/8"	26DS*	34-45	60G-26DS*	33-5/8"	33-5	27-30	60G-335
12-5/8"	12-2	6-9	60G-122	19-5/8"	19-4	15-16	60G-194	27-5/8"	27-1	4-8	60G-271	33-5/8"	33-6	30-31	60G-336
12-5/8"	12-3	9-11	60G-123	19-5/8"	19-5	16-20	60G-195	27-5/8"	27-2	8-12	60G-272	33-5/8"	33-9	31-36	60G-339
12-5/8"	12-4	11-12	60G-124	19-5/8"	19-6	20-25	60G-196	27-5/8"	27-3	12-18	60G-273	33-5/8"	33DS*	37-45	60G-33DS*
12-5/8"	12-5	12-15	60G-125	19-5/8"	19-9	25-29	60G-199	27-5/8"	27-4	18-25	60G-274	34-5/8"	34-1	7-12	60G-341
12-5/8"	12-6	15-18	60G-126	19-5/8"	19DS*	30-40	60G-19DS*	27-5/8"	27-5	25-28	60G-275	34-5/8"	34-2	12-17	60G-342
12-5/8"	12-9	18-21	60G-129	20-5/8"	20-1	4-7	60G-201	27-5/8"	27-6	28-31	60G-276	34-5/8"	34-3	17-22	60G-343
12-5/8"	12DS*	22-30	60G-12DS*	20-5/8"	20-2	7-11	60G-202	27-5/8"	27-9	31-33	60G-279	34-5/8"	34-4	22-28	60G-344
13-5/8"	13-1	3-6	60G-131	20-5/8"	20-3	11-14	60G-203	27-5/8"	27DS*	34-45	60G-27DS*	34-5/8"	34-5	28-32	60G-345
13-5/8"	13-2	6-9	60G-132	20-5/8"	20-4	14-22	60G-204	28-5/8"	28-1	6-11	60G-281	34-5/8"	34-6	32-34	60G-346
13-5/8"	13-3	9-11	60G-133	20-5/8"	20-5	22-25	60G-205	28-5/8"	28-2	11-15	60G-282	34-5/8"	34-9	34-36	60G-349
13-5/8"	13-4	11-12	60G-134	20-5/8"	20-6	25-28	60G-206	28-5/8"	28-3	15-22	60G-283	34-5/8"	34DS*	37-45	60G-34DS*
13-5/8"	13-5	12-16	60G-135	20-5/8"	20-9	28-31	60G-209	28-5/8"	28-4	22-27	60G-284	35-5/8"	35-1	7-12	60G-351
13-5/8"	13-6	16-19	60G-136	20-5/8"	20DS*	31-40	60G-20DS*	28-5/8"	28-5	27-31	60G-285	35-5/8"	35-2	12-17	60G-352
13-5/8"	13-9	16-22	60G-139	21-5/8"	21-1	4-7	60G-211	28-5/8"	28-6	31-34	60G-286	35-5/8"	35-3	17-21	60G-353
13-5/8"	13DS*	22-35	60G-13DS*	21-5/8"	21-2	7-11	60G-212	28-5/8"	28-9	34-36	60G-289	35-5/8"	35-4	21-28	60G-354
14-5/8"	14-1	4-6	60G-141	21-5/8"	21-3	11-14	60G-213	28-5/8"	28DS*	37-45	60G-28DS*	35-5/8"	35-5	28-33	60G-355
14-5/8"	14-2	6-9	60G-142	21-5/8"	21-4	14-22	60G-214	29-5/8"	29-1	6-11	60G-291	35-5/8"	35-9	33-36	60G-359
14-5/8"	14-3	9-11	60G-143	21-5/8"	21-5	22-25	60G-215	29-5/8"	29-2	11-15	60G-292	35-5/8"	35DS*	37-45	60G-35DS*
14-5/8"	14-4	11-12	60G-144	21-5/8"	21-9	25-30	60G-219	29-5/8"	29-3	15-22	60G-293	36-5/8"	36-1	7-12	60G-361
14-5/8"	14-5	12-17	60G-145	21-5/8"	21DS*	31-40	60G-21DS*	29-5/8"	29-4	22-27	60G-294	36-5/8"	36-2	12-16	60G-362
14-5/8"	14-6	17-22	60G-146	22-5/8"	22-1	4-7	60G-221	29-5/8"	29-5	27-30	60G-295	36-5/8"	36-3	16-21	60G-363
14-5/8"	14-9	22-25	60G-149	22-5/8"	22-2	7-11	60G-222	29-5/8"	29-6	30-33	60G-296	36-5/8"	36-4	21-28	60G-364
14-5/8"	14DS*	26-35	60G-14DS*	22-5/8"	22-3	11-18	60G-223	29-5/8"	29-9	33-36	60G-299	36-5/8"	36-5	28-33	60G-365
15-5/8"	15-1	4-6	60G-151	22-5/8"	22-4	18-22	60G-224	29-5/8"	29DS*	37-45	60G-29DS*	36-5/8"	36-9	33-38	60G-369
15-5/8"	15-2	6-8	60G-152	22-5/8"	22-5	22-26	60G-225	30-5/8"	30-1	6-11	60G-301	36-5/8"	36DS*	39-45	60G-36DS*
15-5/8"	15-3	8-11	60G-153	22-5/8"	22-9	26-30	60G-229	30-5/8"	30-2	11-15	60G-302	37-5/8"	37-1	7-12	60G-371
15-5/8"	15-4	11-12	60G-154	22-5/8"	22DS*	31-40	60G-22DS*	30-5/8"	30-3	15-22	60G-303	37-5/8"	37-2	12-16	60G-372
15-5/8"	15-5	12-16	60G-155	23-5/8"	23-1	4-8	60G-231	30-5/8"	30-4	22-27	60G-304	37-5/8"	37-3	16-21	60G-373
15-5/8"	15-6	16-21	60G-156	23-5/8"	23-2	8-14	60G-232	30-5/8"	30-5	27-30	60G-305	37-5/8"	37-4	21-30	60G-374
15-5/8"	15-9	21-23	60G-159	23-5/8"	23-3	14-17	60G-233	30-5/8"	30-6	30-33	60G-306	37-5/8"	37-5	30-34	60G-375
15-5/8"	15DS*	24-35	60G-15DS*	23-5/8"	23-4	17-21	60G-234	30-5/8"	30-9	33-36	60G-309	37-5/8"	37-9	34-38	60G-379
16-5/8"	16-1	4-7	60G-161	23-5/8"	23-5	21-26	60G-235	30-5/8"	30DS*	37-45	60G-30DS*	37-5/8"	37DS*	39-45	60G-37DS*
16-5/8"	16-2	7-11	60G-162	23-5/8"	23-9	26-30	60G-239	31-5/8"	31-1	7-12	60G-311	38-5/8"	38-1	7-12	60G-381
16-5/8"	16-3	11-13	60G-163	23-5/8"	23DS*	31-40	60G-23DS*	31-5/8"	31-2	12-15	60G-312	38-5/8"	38-2	12-17	60G-382
16-5/8"	16-4	13-18	60G-164	24-5/8"	24-1	4-8	60G-241	31-5/8"	31-3	15-22	60G-313	38-5/8"	38-3	17-22	60G-383
16-5/8"	16-5	18-22	60G-165	24-5/8"	24-2	8-14	60G-242	31-5/8"	31-4	22-27	60G-314	38-5/8"	38-4	22-28	60G-384
16-5/8"	16-9	22-26	60G-169	24-5/8"	24-3	14-18	60G-243	31-5/8"	31-5	27-30	60G-315	38-5/8"	38-5	28-34	60G-385
16-5/8"	16DS*	27-35	60G-16DS*	24-5/8"	24-4	18-23	60G-244	31-5/8"	31-6	30-33	60G-316	38-5/8"	38-9	34-38	60G-389
17-5/8"	17-1	4-7	60G-171	24-5/8"	24-5	23-29	60G-245	31-5/8"	31-9	33-36	60G-319	38-5/8"	38DS*	39-45	60G-38DS*
17-5/8"	17-2	7-11	60G-172	24-5/8"	24-9	29-34	60G-249	31-5/8"	31DS*	37-45	60G-31DS*	39-5/8"	39-1	7-12	60G-391
17-5/8"	17-3	11-13	60G-173	24-5/8"	24DS*	35-45	60G-24DS*	32-5/8"	32-1	7-12	60G-321	39-5/8"	39-2	12-17	60G-392
17-5/8"	17-4	13-15	60G-174	25-5/8"	25-1	4-8	60G-251	32-5/8"	32-2	12-17	60G-322	39-5/8"	39-3	17-22	60G-393
17-5/8"	17-5	15-19	60G-175	25-5/8"	25-2	8-14	60G-252	32-5/8"	32-3	17-22	60G-323	39-5/8"	39-4	22-28	60G-394
17-5/8"	17-9	19-26	60G-179	25-5/8"	25-3	14-18	60G-253	32-5/8"	32-4	22-27	60G-324	39-5/8"	39-5	28-34	60G-395
17-5/8"	17DS*	27-35	60G-17DS*	25-5/8"	25-4	18-24	60G-254	32-5/8"	32-5	27-30	60G-325	39-5/8"	39-9	34-38	60G-399
18-5/8"	18-1	4-7	60G-181	25-5/8"	25-5	24-30	60G-255	32-5/8"	32-6	30-31	60G-326	39-5/8"	39DS*	39-45	60G-39DS*
18-5/8"	18-2	7-11	60G-182	25-5/8"	25-9	30-34	60G-259	32-5/8"	32-9	31-36	60G-329	40-5/8"	40-1	7-12	60G-401
18-5/8"	18-3	11-13	60G-183	25-5/8"	25DS*	35-45	60G-25DS*	32-5/8"	32DS*	37-45	60G-32DS*	40-5/8"	40-2	12-17	60G-402
18-5/8"	18-4	13-16	60G-184	26-5/8"	26-1	4-8	60G-261	33-5/8"	33-1	7-12	60G-331	40-5/8"	40-3	17-21	60G-403
18-5/8"	18-5	16-23	60G-185	26-5/8"	26-2	8-12	60G-262	33-5/8"	33-2	12-17	60G-332	40-5/8"	40-4	21-28	60G-404
18-5/8"	18-6	23-26	60G-186	26-5/8"	26-3	12-18	60G-263	33-5/8"	33-3	17-22	60G-333	40-5/8"	40-5	28-34	60G-405
18-5/8"	18-9	26-29	60G-189	26-5/8"	26-4	18-25	60G-264	33-5/8"	33-4	22-27	60G-334	40-5/8"	40-9	34-40	60G-409
18-5/8"	18DS*	30-35	60G-18DS*	26-5/8"	26-5	25-28	60G-265	33-5/8"	33-5	27-30	60G-335	40-5/8"	40DS*	41-45	60G-40DS*
19-5/8"	19-1	4-7	60G-191	26-5/8"	26-6	28-31	60G-266	33-5/8"	33-6	30-31	60G-336	41-5/8"	41-1	7-12	60G-411
19-5/8"	19-2	7-11	60G-192	26-5/8"	26-9	31-33	60G-269	33-5/8"	33-9	31-36	60G-339	41-5/8"	41-2	12-17	60G-412

Continued on next page

## 60G SERIES BALANCE ACCESSORIES

Continued from previous page

Length of Metal Channel	Number Stamped on Balance	Sash Weight	Our Part Number	Length of Metal Channel	Number Stamped on Balance	Sash Weight	Our Part Number	Length of Metal Channel	Number Stamped on Balance	Sash Weight	Our Part Number	Length of Metal Channel	Number Stamped on Balance	Sash Weight	Our Part Number
41-5/8"	41-3	17-22	60G-413	44-5/8"	44-5	28-35	60G-445	47-5/8"	47DS*	42-45	60G-47DS*	51-5/8"	51-1	7-12	60G-511
41-5/8"	41-4	22-28	60G-414	44-5/8"	44-9	35-40	60G-449	48-5/8"	48-1	7-12	60G-481	51-5/8"	51-2	12-17	60G-512
41-5/8"	41-5	28-34	60G-415	44-5/8"	44DS*	41-45	60G-44DS*	48-5/8"	48-2	12-17	60G-482	51-5/8"	51-3	17-22	60G-513
41-5/8"	41-9	34-41	60G-419	45-5/8"	45-1	7-12	60G-451	48-5/8"	48-3	17-22	60G-483	51-5/8"	51-4	22-29	60G-514
41-5/8"	41DS*	41-45	60G-41DS*	45-5/8"	45-2	12-17	60G-452	48-5/8"	48-4	22-30	60G-484	51-5/8"	51-5	29-34	60G-515
42-5/8"	42-1	7-12	60G-421	45-5/8"	45-3	17-22	60G-453	48-5/8"	48-5	30-34	60G-485	51-5/8"	51-9	34-41	60G-519
42-5/8"	42-2	12-17	60G-422	45-5/8"	45-4	22-28	60G-454	48-5/8"	48-9	35-41	60G-489	51-5/8"	51DS*	42-45	60G-51DS*
42-5/8"	42-3	17-22	60G-423	45-5/8"	45-5	28-35	60G-455	48-5/8"	48DS*	42-45	60G-48DS*	52-5/8"	52-1	7-12	60G-521
42-5/8"	42-4	22-28	60G-424	45-5/8"	45-9	35-40	60G-459	49-5/8"	49-1	7-12	60G-491	52-5/8"	52-2	12-17	60G-522
42-5/8"	42-5	28-34	60G-425	45-5/8"	45DS*	41-45	60G-45DS*	49-5/8"	49-2	12-17	60G-492	52-5/8"	52-3	17-22	60G-523
42-5/8"	42-9	34-40	60G-429	46-5/8"	46-1	7-12	60G-461	49-5/8"	49-3	17-22	60G-493	52-5/8"	52-4	22-29	60G-524
42-5/8"	42DS*	41-45	60G-42DS*	46-5/8"	46-2	12-17	60G-462	49-5/8"	49-4	22-29	60G-494	52-5/8"	52-5	29-34	60G-525
43-5/8"	43-1	7-12	60G-431	46-5/8"	46-3	17-22	60G-463	49-5/8"	49-5	29-34	60G-495	52-5/8"	52-9	34-41	60G-529
43-5/8"	43-2	12-17	60G-432	46-5/8"	46-4	22-28	60G-464	49-5/8"	49-9	34-41	60G-499	52-5/8"	52DS*	42-45	60G-52DS*
43-5/8"	43-3	17-22	60G-433	46-5/8"	46-5	28-35	60G-465	49-5/8"	49DS*	42-45	60G-49DS*	53-5/8"	53-1	7-12	60G-531
43-5/8"	43-4	22-28	60G-434	46-5/8"	46-9	35-41	60G-469	50-5/8"	50-1	7-12	60G-501	52-5/8"	53-2	12-17	60G-532
43-5/8"	43-5	28-34	60G-435	46-5/8"	46DS*	42-45	60G-46DS*	50-5/8"	50-2	12-17	60G-502	53-5/8"	53-3	17-23	60G-533
43-5/8"	43-9	34-40	60G-439	47-5/8"	47-1	7-12	60G-471	50-5/8"	50-3	17-22	60G-503	53-5/8"	53-4	23-31	60G-534
43-5/8"	43DS*	41-45	60G-43DS*	47-5/8"	47-2	12-17	60G-472	50-5/8"	50-4	22-29	60G-504	53-5/8"	53-5	31-36	60G-535
44-5/8"	44-1	7-12	60G-441	47-5/8"	47-3	17-22	60G-473	50-5/8"	50-5	29-34	60G-505	53-5/8"	53-9	36-41	60G-539
44-5/8"	44-2	12-17	60G-442	47-5/8"	47-4	22-28	60G-474	50-5/8"	50-9	34-41	60G-509	53-5/8"	53DS*	42-45	60G-53DS*
44-5/8"	44-3	17-22	60G-443	47-5/8"	47-5	28-35	60G-475	50-5/8"	51DS*	42-45	60G-51DS*				
44-5/8"	44-4	22-28	60G-444	47-5/8"	47-9	35-41	60G-479	51-5/8"	51-1	7-12	60G-511				

## 60G SERIES ENDS & CLIP COMBINATIONS

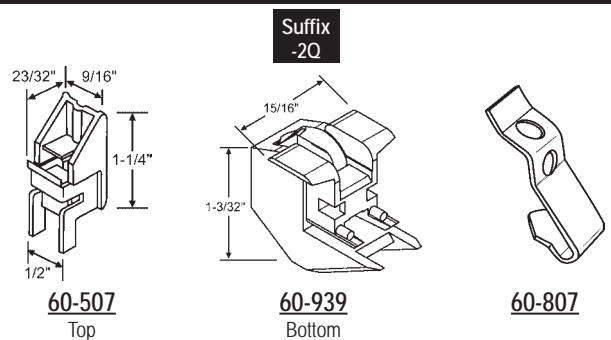
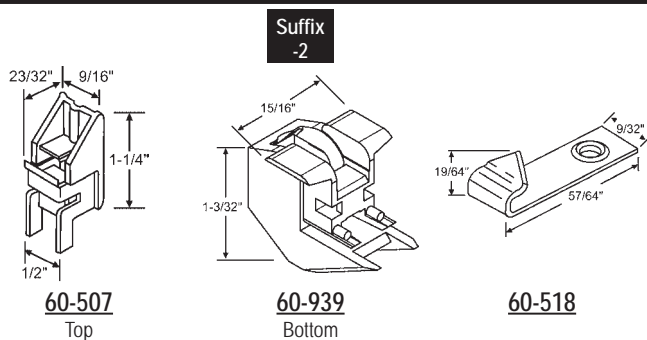
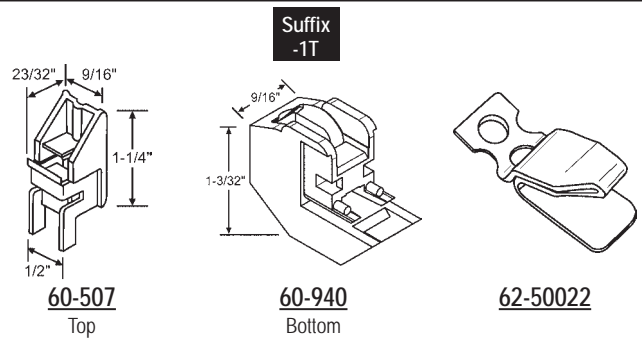
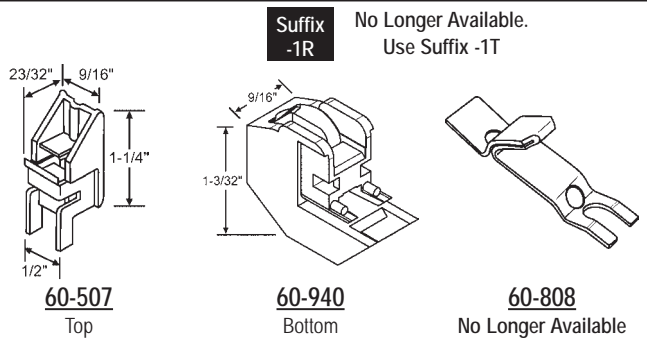
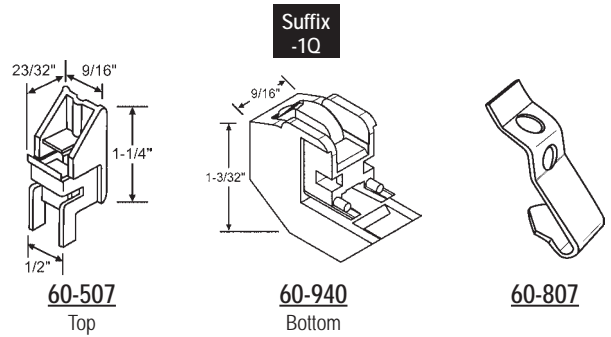
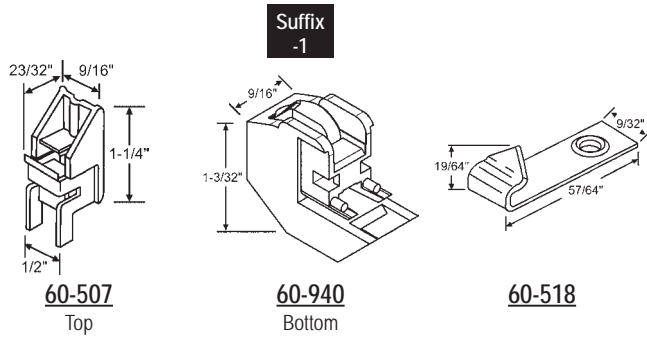

# SASH SUPPORT SYSTEMS

## 60G SERIES ENDS & CLIP COMBINATIONS

**Suffix  
-2R**

No Longer Available.  
Use Suffix -2T

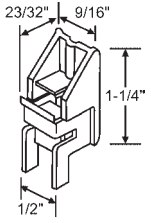

**60-507**  
Top

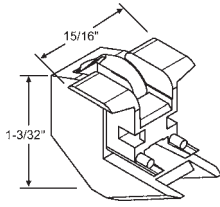

**60-939**  
Bottom

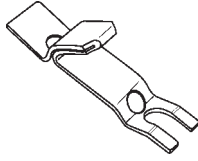

**60-808**  
No Longer Available

**Suffix  
-2T**

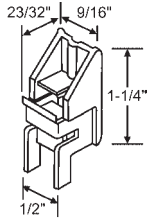

**60-507**  
Top

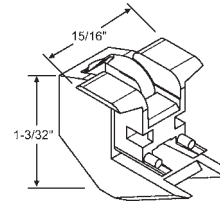

**60-939**  
Bottom



**62-50022**

**Suffix  
-3**

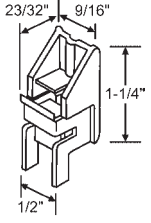

**60-507**  
Top

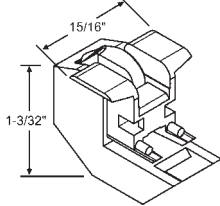

**60-938**  
Bottom

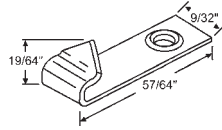

**60-518**

**Suffix  
-3Q**

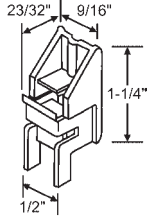

**60-507**  
Top

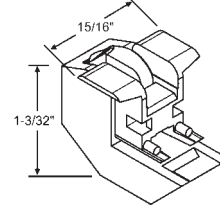

**60-938**  
Bottom



**60-807**

**Suffix  
-3R**

No Longer Available.  
Use Suffix -3T

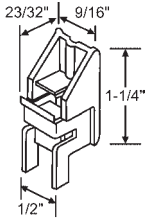

**60-507**  
Top

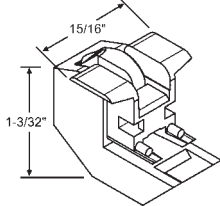

**60-938**  
Bottom

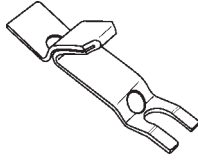

**60-808**  
No Longer Available

**Suffix  
-3T**

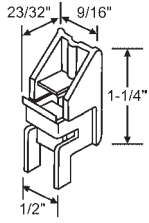

**60-507**  
Top

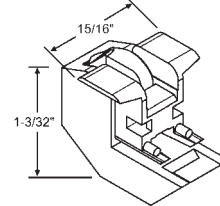

**60-938**  
Bottom

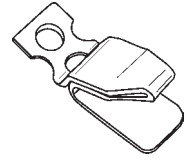

**62-50022**

**Suffix  
-4**

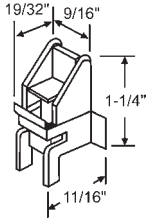

**60-508**  
Top

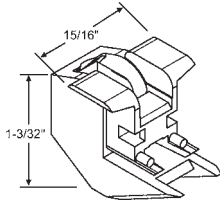

**60-939**  
Bottom

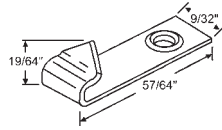

**60-518**

**Suffix  
-4Q**

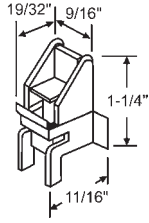

**60-508**  
Top

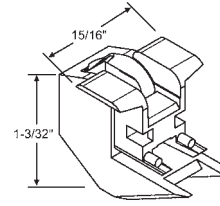

**60-939**  
Bottom



**60-807**

**Suffix  
-4R**

No Longer Available.  
Use Suffix -4T

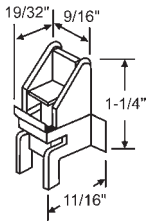

**60-508**  
Top

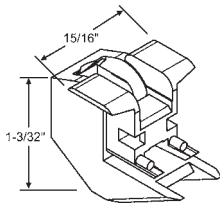

**60-939**  
Bottom

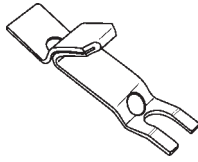

**60-808**  
No Longer Available

**Suffix  
-4T**

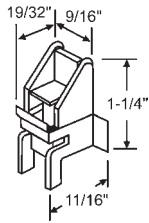

**60-508**  
Top

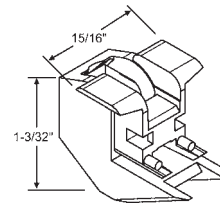

**60-939**  
Bottom



**62-50022**





## 61 SERIES CHANNEL BALANCE WITH HEMMED EDGE

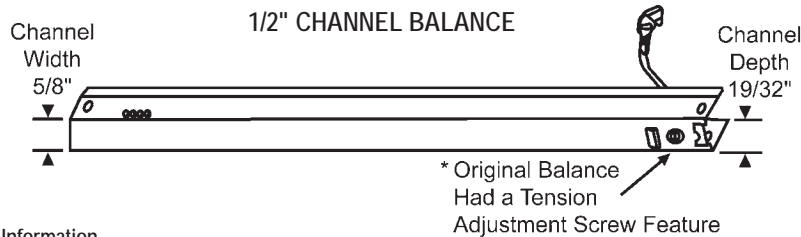

### Ordering Information

- 1) Measure metal channel length (do not include plastic ends).
- 2) Check number stamped on channel (e.g. 20-2, 30-5, etc.).
- 3) Select our corresponding part number from the chart below.
- 4) To identify the top and bottom ends to be attached, refer to page 31.

### General Information

- 1) Balance prices do not include attached bracket.
- \*2) The tension adjustment screw feature is no longer manufactured.
- 3) The top spring anchor is directly attached to the back wall of the balance channel with a porcupine pinning effect.
- 4) For special channel lengths, please consult your representative.

Note: Top and bottom balance ends must be ordered separately. If you want ends attached, add the letter "A" to the suffix of the part number when ordering.

Length of Metal Channel	Number Stamped on Balance	Sash Weight	Our Part Number	Length of Metal Channel	Number Stamped on Balance	Sash Weight	Our Part Number	Length of Metal Channel	Number Stamped on Balance	Sash Weight	Our Part Number	Length of Metal Channel	Number Stamped on Balance	Sash Weight	Our Part Number
11"	10-0	2 To 3 Lbs.	61-100	19"	18-5	17 To 24 Lbs.	61-185	28"	27-4	20 To 26 Lbs.	61-274	36"	35-5	30 To 35 Lbs.	61-355
11"	10-1	3 To 5 Lbs.	61-101	19"	18-6	24 To 27 Lbs.	61-186	28"	27-5	26 To 30 Lbs.	61-275	36"	35-9	35 To 40 Lbs.	61-359
11"	10-2	5 To 8 Lbs.	61-102	19"	18-9	27 To 30 Lbs.	61-189	28"	27-6	30 To 34 Lbs.	61-276	37"	36-1	8 To 13 Lbs.	61-361
11"	10-3	8 To 10 Lbs.	61-103	20"	19-1	5 To 8 Lbs.	61-191	28"	27-9	34 To 36 Lbs.	61-279	37"	36-2	13 To 18 Lbs.	61-362
11"	10-4	10 To 13 Lbs.	61-104	20"	19-2	8 To 12 Lbs.	61-192	29"	28-1	6 To 12 Lbs.	61-281	37"	36-3	18 To 24 Lbs.	61-363
11"	10-5	13 To 15 Lbs.	61-105	20"	19-3	12 To 15 Lbs.	61-193	29"	28-2	12 To 16 Lbs.	61-282	37"	36-4	24 To 31 Lbs.	61-364
11"	10-9	15 To 18 Lbs.	61-109	20"	19-4	15 To 17 Lbs.	61-194	29"	28-3	16 To 23 Lbs.	61-283	37"	36-5	31 To 36 Lbs.	61-365
12"	11-1	3 To 5 Lbs.	61-111	20"	19-5	17 To 21 Lbs.	61-195	29"	28-4	23 To 29 Lbs.	61-284	37"	36-9	36 To 40 Lbs.	61-369
12"	11-2	5 To 8 Lbs.	61-112	20"	19-6	21 To 26 Lbs.	61-196	29"	28-5	29 To 32 Lbs.	61-285	38"	37-1	8 To 13 Lbs.	61-371
12"	11-3	8 To 10 Lbs.	61-113	20"	19-9	26 To 30 Lbs.	61-199	29"	28-6	32 To 35 Lbs.	61-286	38"	37-2	13 To 19 Lbs.	61-372
12"	11-4	10 To 12 Lbs.	61-114	21"	20-1	4 To 8 Lbs.	61-201	29"	28-9	35 To 38 Lbs.	61-289	38"	37-3	19 To 24 Lbs.	61-373
12"	11-5	12 To 15 Lbs.	61-115	21"	20-2	8 To 12 Lbs.	61-202	30"	29-1	6 To 12 Lbs.	61-291	38"	37-4	24 To 32 Lbs.	61-374
12"	11-9	15 To 18 Lbs.	61-119	21"	20-3	12 To 16 Lbs.	61-203	30"	29-2	12 To 17 Lbs.	61-292	38"	37-5	32 To 36 Lbs.	61-375
13"	12-1	3 To 6 Lbs.	61-121	21"	20-4	16 To 23 Lbs.	61-204	30"	29-3	17 To 24 Lbs.	61-293	38"	37-9	36 To 40 Lbs.	61-379
13"	12-2	6 To 9 Lbs.	61-122	21"	20-5	23 To 26 Lbs.	61-205	30"	29-4	24 To 28 Lbs.	61-294	39"	38-1	9 To 14 Lbs.	61-381
13"	12-3	9 To 10 Lbs.	61-123	21"	20-9	26 To 30 Lbs.	61-209	30"	29-5	28 To 32 Lbs.	61-295	39"	38-2	14 To 19 Lbs.	61-382
13"	12-4	10 To 12 Lbs.	61-124	22"	21-1	4 To 8 Lbs.	61-211	30"	29-6	32 To 35 Lbs.	61-296	39"	38-3	19 To 25 Lbs.	61-383
13"	12-5	12 To 15 Lbs.	61-125	22"	21-2	8 To 12 Lbs.	61-212	30"	29-9	35 To 38 Lbs.	61-299	39"	38-4	25 To 30 Lbs.	61-384
13"	12-6	15 To 19 Lbs.	61-126	22"	21-3	12 To 15 Lbs.	61-213	31"	30-1	6 To 12 Lbs.	61-301	39"	38-5	30 To 36 Lbs.	61-385
13"	12-9	19 To 22 Lbs.	61-129	22"	21-4	15 To 23 Lbs.	61-214	31"	30-2	12 To 17 Lbs.	61-302	39"	38-9	36 To 40 Lbs.	61-389
14"	13-1	3 To 6 Lbs.	61-131	22"	21-5	23 To 26 Lbs.	61-215	31"	30-3	17 To 23 Lbs.	61-303	40"	39-1	9 To 14 Lbs.	61-391
14"	13-2	6 To 9 Lbs.	61-132	22"	21-9	26 To 30 Lbs.	61-219	31"	30-4	23 To 28 Lbs.	61-304	40"	39-2	14 To 19 Lbs.	61-392
14"	13-3	9 To 10 Lbs.	61-133	23"	22-1	4 To 8 Lbs.	61-221	31"	30-5	28 To 33 Lbs.	61-305	40"	39-3	19 To 25 Lbs.	61-393
14"	13-4	10 To 12 Lbs.	61-134	23"	22-2	8 To 12 Lbs.	61-222	31"	30-6	33 To 35 Lbs.	61-306	40"	39-4	25 To 31 Lbs.	61-394
14"	13-5	12 To 17 Lbs.	61-135	23"	22-3	12 To 19 Lbs.	61-223	31"	30-9	35 To 38 Lbs.	61-309	40"	39-5	31 To 36 Lbs.	61-395
14"	13-9	17 To 22 Lbs.	61-139	23"	22-4	19 To 23 Lbs.	61-224	32"	31-1	6 To 12 Lbs.	61-311	40"	39-9	36 To 40 Lbs.	61-399
15"	14-1	4 To 6 Lbs.	61-141	23"	22-5	23 To 27 Lbs.	61-225	32"	31-2	12 To 16 Lbs.	61-312	41"	40-1	9 To 14 Lbs.	61-401
15"	14-2	6 To 9 Lbs.	61-142	23"	22-9	27 To 30 Lbs.	61-229	32"	31-3	16 To 23 Lbs.	61-313	41"	40-2	14 To 20 Lbs.	61-402
15"	14-3	9 To 11 Lbs.	61-143	24"	23-1	4 To 9 Lbs.	61-231	32"	31-4	23 To 28 Lbs.	61-314	41"	40-3	20 To 25 Lbs.	61-403
15"	14-4	11 To 13 Lbs.	61-144	24"	23-2	9 To 15 Lbs.	61-232	32"	31-5	28 To 32 Lbs.	61-315	41"	40-4	25 To 31 Lbs.	61-404
15"	14-5	13 To 18 Lbs.	61-145	24"	23-3	15 To 18 Lbs.	61-233	32"	31-6	32 To 35 Lbs.	61-316	41"	40-5	31 To 36 Lbs.	61-405
15"	14-6	18 To 23 Lbs.	61-146	24"	23-4	18 To 22 Lbs.	61-234	32"	31-9	35 To 38 Lbs.	61-319	41"	40-9	36 To 42 Lbs.	61-409
15"	14-9	23 To 26 Lbs.	61-149	24"	23-5	22 To 27 Lbs.	61-235	33"	32-1	7 To 13 Lbs.	61-321	42"	41-1	9 To 14 Lbs.	61-411
16"	15-1	4 To 6 Lbs.	61-151	24"	23-9	27 To 30 Lbs.	61-239	33"	32-2	13 To 19 Lbs.	61-322	42"	41-2	14 To 19 Lbs.	61-412
16"	15-2	6 To 9 Lbs.	61-152	25"	24-1	4 To 9 Lbs.	61-241	33"	32-3	19 To 23 Lbs.	61-323	42"	41-3	19 To 25 Lbs.	61-413
16"	15-3	9 To 11 Lbs.	61-153	25"	24-2	9 To 15 Lbs.	61-242	33"	32-4	23 To 29 Lbs.	61-324	42"	41-4	25 To 31 Lbs.	61-414
16"	15-4	11 To 13 Lbs.	61-154	25"	24-3	15 To 19 Lbs.	61-243	33"	32-5	29 To 32 Lbs.	61-325	42"	41-5	31 To 37 Lbs.	61-415
16"	15-5	13 To 17 Lbs.	61-155	25"	24-4	19 To 24 Lbs.	61-244	33"	32-6	32 To 34 Lbs.	61-326	42"	41-9	37 To 42 Lbs.	61-419
16"	15-6	17 To 22 Lbs.	61-156	25"	24-5	24 To 30 Lbs.	61-245	33"	32-9	34 To 38 Lbs.	61-329	43"	42-1	9 To 14 Lbs.	61-421
16"	15-9	22 To 26 Lbs.	61-159	25"	24-9	30 To 34 Lbs.	61-249	34"	33-1	8 To 13 Lbs.	61-331	43"	42-2	14 To 20 Lbs.	61-422
17"	16-1	5 To 8 Lbs.	61-161	26"	25-1	4 To 9 Lbs.	61-251	34"	33-2	13 To 18 Lbs.	61-332	43"	42-3	20 To 25 Lbs.	61-423
17"	16-2	8 To 11 Lbs.	61-162	26"	25-2	9 To 15 Lbs.	61-252	34"	33-3	18 To 24 Lbs.	61-333	43"	42-4	25 To 31 Lbs.	61-424
17"	16-3	11 To 14 Lbs.	61-163	26"	25-3	15 To 20 Lbs.	61-253	34"	33-4	24 To 29 Lbs.	61-334	43"	42-5	31 To 36 Lbs.	61-425
17"	16-4	14 To 19 Lbs.	61-164	26"	25-4	20 To 25 Lbs.	61-254	34"	33-5	29 To 32 Lbs.	61-335	43"	42-9	36 To 42 Lbs.	61-429
17"	16-5	19 To 23 Lbs.	61-165	26"	25-5	25 To 31 Lbs.	61-255	34"	33-6	32 To 35 Lbs.	61-336	44"	43-1	9 To 14 Lbs.	61-431
17"	16-9	23 To 26 Lbs.	61-169	26"	25-9	31 To 34 Lbs.	61-259	34"	33-9	35 To 38 Lbs.	61-339	44"	43-2	14 To 19 Lbs.	61-432
18"	17-1	5 To 8 Lbs.	61-171	27"	26-1	5 To 9 Lbs.	61-261	35"	34-1	8 To 13 Lbs.	61-341	44"	43-3	19 To 24 Lbs.	61-433
18"	17-2	8 To 11 Lbs.	61-172	27"	26-2	9 To 13 Lbs.	61-262	35"	34-2	13 To 18 Lbs.	61-342	44"	43-4	24 To 30 Lbs.	61-434
18"	17-3	11 To 14 Lbs.	61-173	27"	26-3	13 To 19 Lbs.	61-263	35"	34-3	18 To 24 Lbs.	61-343	44"	43-5	30 To 36 Lbs.	61-435
18"	17-4	14 To 17 Lbs.	61-174	27"	26-4	19 To 26 Lbs.	61-264	35"	34-4	24 To 31 Lbs.	61-344	44"	43-9	36 To 42 Lbs.	61-439
18"	17-5	17 To 20 Lbs.	61-175	27"	26-5	26 To 30 Lbs.	61-265	35"	34-5	31 To 34 Lbs.	61-345	45"	44-1	9 To 14 Lbs.	61-441
18"	17-9	20 To 26 Lbs.	61-179	27"	26-6	30 To 33 Lbs.	61-266	35"	34-9	34 To 38 Lbs.	61-349	45"	44-2	14 To 20 Lbs.	61-442
19"	18-1	5 To 8 Lbs.	61-181	27"	26-9	33 To 34 Lbs.	61-269	36"	35-1	8 To 13 Lbs.	61-351	45"	44-3	20 To 24 Lbs.	61-443
19"	18-2	8 To 11 Lbs.	61-182	28"	27-1	5 To 9 Lbs.	61-271	36"	35-2	13 To 18 Lbs.	61-352	45"	44-4	24 To 31 Lbs.	61-444
19"	18-3	11 To 14 Lbs.	61-183	28"	27-2	9 To 13 Lbs.	61-272	36"	35-3	18 To 23 Lbs.	61-353	45"	44-5	31 To 36 Lbs.	61-445
19"	18-4	14 To 17 Lbs.	61-184	28"	27-3	13 To 20 Lbs.	61-273	36"	35-4	23 To 30 Lbs.	61-354	45"	44-9	36 To 42 Lbs.	61-449

Continued on next page

## 61 SERIES CHANNEL BALANCE WITH HEMMED EDGE

Continued from previous page.

Length of Metal Channel	Number Stamped on Balance	Sash Weight	Our Part Number	Length of Metal Channel	Number Stamped on Balance	Sash Weight	Our Part Number	Length of Metal Channel	Number Stamped on Balance	Sash Weight	Our Part Number	Length of Metal Channel	Number Stamped on Balance	Sash Weight	Our Part Number
46"	45-1	9 To 14 Lbs.	61-451	48"	47-4	24 To 30 Lbs.	61-474	51"	50-1	9 To 15 Lbs.	61-5010	53"	52-4	24 To 32 Lbs.	61-5240
46"	45-2	14 To 19 Lbs.	61-452	48"	47-5	30 To 37 Lbs.	61-475	51"	50-2	15 To 19 Lbs.	61-5020	53"	52-5	32 To 37 Lbs.	61-5250
46"	45-3	19 To 24 Lbs.	61-453	48"	47-9	37 To 44 Lbs.	61-479	51"	50-3	19 To 25 Lbs.	61-5030	53"	52-9	37 To 44 Lbs.	61-5290
46"	45-4	24 To 31 Lbs.	61-454	49"	48-1	9 To 14 Lbs.	61-481	51"	50-4	25 To 32 Lbs.	61-5040	54"	53-1	9 To 14 Lbs.	61-5310
46"	45-5	31 To 37 Lbs.	61-455	49"	48-2	14 To 19 Lbs.	61-482	51"	50-5	32 To 37 Lbs.	61-5050	54"	53-2	14 To 19 Lbs.	61-5320
46"	45-9	37 To 42 Lbs.	61-459	49"	48-3	19 To 24 Lbs.	61-483	51"	50-9	37 To 44 Lbs.	61-5090	54"	53-3	19 To 25 Lbs.	61-5330
47"	46-1	9 To 14 Lbs.	61-461	49"	48-4	24 To 32 Lbs.	61-484	52"	51-1	9 To 14 Lbs.	61-5110	54"	53-4	25 To 34 Lbs.	61-5340
47"	46-2	14 To 19 Lbs.	61-462	49"	48-5	32 To 37 Lbs.	61-485	52"	51-2	14 To 19 Lbs.	61-5120	54"	53-5	34 To 39 Lbs.	61-5350
47"	46-3	19 To 25 Lbs.	61-463	49"	48-9	37 To 44 Lbs.	61-489	52"	51-3	19 To 24 Lbs.	61-5130	54"	53-9	39 To 44 Lbs.	61-5390
47"	46-4	25 To 31 Lbs.	61-464	50"	49-1	9 To 14 Lbs.	61-491	52"	51-4	24 To 32 Lbs.	61-5140	55"	54-3	19 To 24 Lbs.	61-5430
47"	46-5	31 To 37 Lbs.	61-465	50"	49-2	14 To 19 Lbs.	61-492	52"	51-5	32 To 37 Lbs.	61-5150	55"	54-5	32 To 37 Lbs.	61-5450
47"	46-9	37 To 44 Lbs.	61-469	50"	49-3	19 To 24 Lbs.	61-493	52"	51-9	37 To 44 Lbs.	61-5190	55"	54-9	37 To 44 Lbs.	61-5490
48"	47-1	9 To 14 Lbs.	61-471	50"	49-4	24 To 32 Lbs.	61-494	53"	52-1	9 To 14 Lbs.	61-5210	57"	56-5	32 To 37 Lbs.	61-5650
48"	47-2	14 To 19 Lbs.	61-472	50"	49-5	32 To 37 Lbs.	61-495	53"	52-2	14 To 19 Lbs.	61-5220	59"	58-3	19 To 24 Lbs.	61-5830
48"	47-3	19 To 24 Lbs.	61-473	50"	49-9	37 To 44 Lbs.	61-499	53"	52-3	19 To 24 Lbs.	61-5230				

### TOP BRACKETS

60-Series top brackets are all interchangeable with 61-Series balances. Use 61-Series bottom brackets listed below.

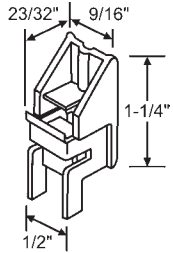

Part #	Color
60-507	White
60-507B	Black

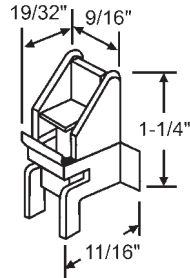

**60-508**

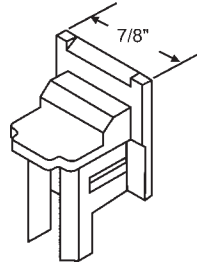

**61-503**  
Use 60-595

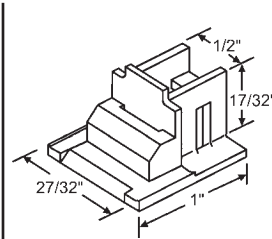

**60-595**

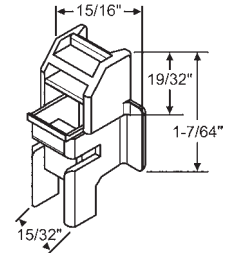

**61-516**  
Nylon  
**PGT/ATRIUM**

### BOTTOM BRACKETS

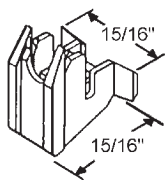

**61-508**

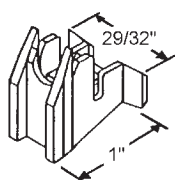

**61-512**

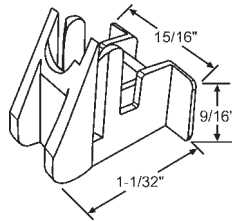

**61-519**  
Nylon  
**PGT/ATRIUM**

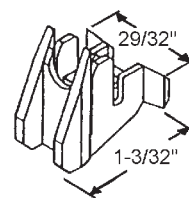

**61-510**

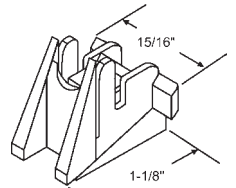

**61-507**

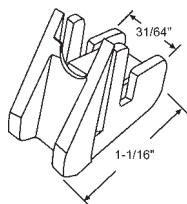

**61-515**  
No Longer Available  
Use: 61-501

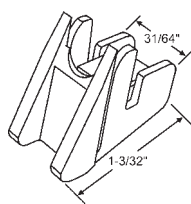

**61-501**

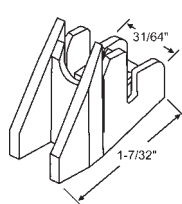

**61-509**

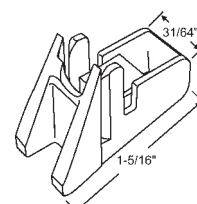

**61-513**

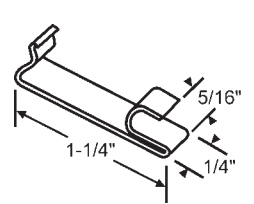

**60-708**  
Take out clip  
**SILVERLINE**

# SASH SUPPORT SYSTEMS

## 61TI SERIES INVERTED TILT BALANCE

### SILVERLINE

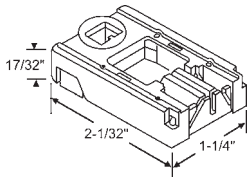

**85-516**  
**SILVERLINE**

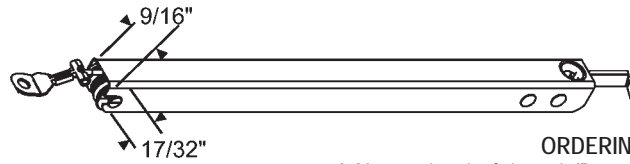

### GENERAL INFORMATION

All Accessories such as pivot lock shoes and pivot bars must be purchased separately. Refer to 85 Series balance accessory pages.

### ORDERING INFORMATION

1. Measure length of channel. (Do not include any attached ends)
2. Check number stamped on channel: e.g. 23-5, 25-7 etc.
3. Check for corresponding sash weight.
4. Select our corresponding part number from the chart below and order accordingly.

Length of Metal Channel	Number Stamped on Balance	Sash Weight	Our Part Number	Length of Metal Channel	Number Stamped on Balance	Sash Weight	Our Part Number	Length of Metal Channel	Number Stamped on Balance	Sash Weight	Our Part Number
10"	9-1	2 - 5	61TI-091	22"	21-5	15 - 19	61TI-215	34"	33-5	25 - 30	61TI-335
10"	9-3	5 - 7	61TI-093	22"	21-7	19 - 24	61TI-217	34"	33-7	30 - 34	61TI-337
10"	9-5	7 - 9	61TI-095	22"	21-9	24 - 28	61TI-219	34"	33-9	34 - 40	61TI-339
10"	9-7	9 - 11	61TI-097	23"	22-1	6 - 10	61TI-221	35"	34-1	14 - 19	61TI-341
11"	10-1	2 - 5	61TI-101	23"	22-3	10 - 14	61TI-223	35"	34-3	19 - 25	61TI-343
11"	10-3	5 - 7	61TI-103	23"	22-5	14 - 18	61TI-225	35"	34-5	25 - 30	61TI-345
11"	10-5	7 - 11	61TI-105	23"	22-7	18 - 24	61TI-227	35"	34-7	30 - 34	61TI-347
11"	10-7	11 - 13	61TI-107	23"	22-9	24 - 28	61TI-229	35"	34-9	34 - 42	61TI-349
11"	10-9	13 - 15	61TI-109	24"	23-1	7 - 10	61TI-231	36"	35-1	14 - 19	61TI-351
12"	11-1	4 - 7	61TI-111	24"	23-3	10 - 14	61TI-233	36"	35-3	19 - 25	61TI-353
12"	11-3	7 - 9	61TI-113	24"	23-5	14 - 19	61TI-235	36"	35-5	25 - 30	61TI-355
12"	11-5	9 - 13	61TI-115	24"	23-7	19 - 25	61TI-237	36"	35-7	30 - 34	61TI-357
12"	11-7	13 - 15	61TI-117	24"	23-9	25 - 30	61TI-239	36"	35-9	34 - 42	61TI-359
12"	11-9	15 - 18	61TI-119	25"	24-1	7 - 11	61TI-241	37"	36-1	14 - 19	61TI-361
13"	12-1	5 - 9	61TI-121	25"	24-3	11 - 17	61TI-243	37"	36-3	19 - 25	61TI-363
13"	12-3	9 - 12	61TI-123	25"	24-5	17 - 24	61TI-245	37"	36-5	25 - 30	61TI-365
13"	12-5	12 - 14	61TI-125	25"	24-7	24 - 30	61TI-247	37"	36-7	30 - 34	61TI-367
13"	12-7	14 - 16	61TI-127	25"	24-9	30 - 34	61TI-249	37"	36-9	34 - 42	61TI-369
13"	12-9	16 - 19	61TI-129	26"	25-1	8 - 13	61TI-251	38"	37-1	14 - 19	61TI-371
14"	13-1	5 - 9	61TI-131	26"	25-3	13 - 19	61TI-253	38"	37-3	19 - 25	61TI-373
14"	13-5	9 - 12	61TI-135	26"	25-5	19 - 24	61TI-255	38"	37-5	25 - 30	61TI-375
14"	13-7	12 - 14	61TI-137	26"	25-7	24 - 30	61TI-257	38"	37-7	30 - 35	61TI-377
14"	13-9	16 - 19	61TI-139	26"	25-9	30 - 34	61TI-259	38"	37-9	35 - 42	61TI-379
15"	14-1	5 - 8	61TI-141	27"	26-1	9 - 12	61TI-261	39"	38-1	14 - 19	61TI-381
15"	14-3	8 - 12	61TI-143	27"	26-3	12 - 17	61TI-263	39"	38-3	19 - 25	61TI-383
15"	14-5	12 - 16	61TI-145	27"	26-5	17 - 23	61TI-265	39"	38-5	25 - 30	61TI-385
15"	14-7	16 - 19	61TI-147	27"	26-7	23 - 30	61TI-267	39"	38-7	30 - 35	61TI-387
15"	14-9	19 - 25	61TI-149	27"	26-9	30 - 34	61TI-269	39"	38-9	35 - 42	61TI-389
16"	15-1	5 - 8	61TI-151	28"	27-1	10 - 14	61TI-271	40"	39-1	14 - 19	61TI-391
16"	15-3	8 - 12	61TI-153	28"	27-3	14 - 19	61TI-273	40"	39-3	19 - 25	61TI-393
16"	15-5	12 - 16	61TI-155	28"	27-5	19 - 24	61TI-275	40"	39-5	25 - 31	61TI-395
16"	15-7	16 - 19	61TI-157	28"	27-7	24 - 31	61TI-277	40"	39-7	31 - 35	61TI-397
16"	15-9	19 - 25	61TI-159	28"	27-9	31 - 34	61TI-279	40"	39-9	35 - 42	61TI-399
17"	16-1	5 - 8	61TI-161	29"	28-1	10 - 14	61TI-281	41"	40-1	14 - 19	61TI-401
17"	16-3	8 - 12	61TI-163	29"	28-3	14 - 20	61TI-283	41"	40-3	19 - 25	61TI-403
17"	16-5	12 - 16	61TI-165	29"	28-5	20 - 27	61TI-285	41"	40-5	25 - 31	61TI-405
17"	16-7	16 - 20	61TI-167	29"	28-7	27 - 34	61TI-287	41"	40-7	31 - 35	61TI-407
17"	16-9	20 - 24	61TI-169	29"	28-9	34 - 38	61TI-289	41"	40-9	35 - 42	61TI-409
18"	17-1	5 - 8	61TI-171	30"	29-1	10 - 14	61TI-291	42"	41-1	13 - 19	61TI-411
18"	17-3	8 - 12	61TI-173	30"	29-3	14 - 21	61TI-293	42"	41-3	19 - 25	61TI-413
18"	17-5	12 - 16	61TI-175	30"	29-5	21 - 27	61TI-295	42"	41-5	25 - 31	61TI-415
18"	17-7	16 - 20	61TI-177	30"	29-7	27 - 34	61TI-297	42"	41-7	31 - 36	61TI-417
18"	17-9	20 - 25	61TI-179	30"	29-9	34 - 38	61TI-299	42"	41-9	36 - 42	61TI-419
19"	18-1	5 - 9	61TI-181	31"	30-1	12 - 16	61TI-301	43"	42-1	14 - 19	61TI-421
19"	18-3	9 - 12	61TI-183	31"	30-3	16 - 23	61TI-303	43"	42-3	19 - 25	61TI-423
19"	18-5	12 - 16	61TI-185	31"	30-5	23 - 28	61TI-305	43"	42-5	25 - 31	61TI-425
19"	18-7	16 - 20	61TI-187	31"	30-7	28 - 34	61TI-307	43"	42-7	31 - 36	61TI-427
19"	18-9	20 - 26	61TI-189	31"	30-9	34 - 38	61TI-309	43"	42-9	36 - 42	61TI-429
20"	19-1	5 - 8	61TI-191	32"	31-1	13 - 17	61TI-311	44"	43-1	14 - 19	61TI-431
20"	19-3	8 - 12	61TI-193	32"	31-3	17 - 23	61TI-313	44"	43-3	19 - 25	61TI-433
20"	19-5	12 - 16	61TI-195	32"	31-5	23 - 28	61TI-315	44"	43-5	25 - 31	61TI-435
20"	19-7	16 - 21	61TI-197	32"	31-7	28 - 34	61TI-317	44"	43-7	31 - 37	61TI-437
20"	19-9	21 - 26	61TI-199	32"	31-9	34 - 38	61TI-319	44"	43-9	37 - 42	61TI-439
21"	20-1	6 - 10	61TI-201	33"	32-1	13 - 18	61TI-321	45"	44-1	14 - 19	61TI-441
21"	20-3	10 - 15	61TI-203	33"	32-3	18 - 24	61TI-323	45"	44-3	19 - 25	61TI-443
21"	20-5	15 - 19	61TI-205	33"	32-5	24 - 29	61TI-325	45"	44-5	25 - 31	61TI-445
21"	20-7	19 - 24	61TI-207	33"	32-7	29 - 34	61TI-327	45"	44-7	31 - 37	61TI-447
21"	20-9	24 - 28	61TI-209	33"	32-9	34 - 40	61TI-329	45"	44-9	37 - 42	61TI-449
22"	21-1	6 - 10	61TI-211	34"	33-1	13 - 19	61TI-331				
22"	21-3	10 - 15	61TI-213	34"	33-3	19 - 25	61TI-333				

## 62 SERIES CHANNEL BALANCES

### 1/2" TILT WINDOW CHANNEL BALANCE

Actually 5/8" but considered 1/2" in the trade.

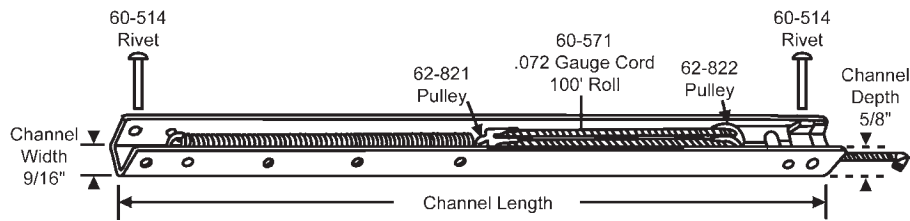

#### Ordering Information

1. Measure channel length (do not include any attached ends).
2. Check number stamped on channel. (e.g., 2210, 22DS, etc.)
3. Select our corresponding part number from the chart below.
4. If the number stamped on the balance ends with DS (double spring), you will need to select the exact weight from the weight range in the chart. An example would be if the number stamped on your balance is 19DS, you'll need to select the exact weight of the sash between 30-40 lbs. (ex. 32lbs). Then add the weight to the part number from the chart below. Ex: 62-19DS32
5. Balances that are 29" & above that have 90 stamped on the balance (ex. 3090) are no longer available. These balances are being substituted with the 50 weight range balances (ex. 3050). Balances that are below 29" & have 90 stamped on the balance (ex. 2590) they will need to be ordered by replacing the 90 that is stamped on the balance with the letter "S" (ex. 2590 to 25S). Then you will need the exact weight of the sash (usually stamped on balance. If not, you'll need to weigh the sash) & add the weight after the letter "S" (ex: if the sash weighs 28lbs, the part number would be 62-25S28).
6. Some balances may be stamped with the letter "U" or "L" that indicates Upper sash or Lower sash. If your balance is stamped with the letter U or L, please add the letter to the end of the part number (ex. 62-305L or 62-25S28U).
7. Identify the appropriate end bracket to be attached from the illustrations shown; then add -1, -2, -3, etc suffix to complete our part number.

**Note:** If your balance has a rivet in the first hole at the top, order separately as part number 60-514A.

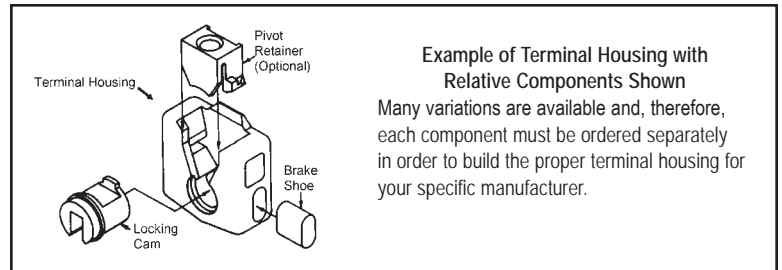

**Example of Terminal Housing with Relative Components Shown**  
Many variations are available and, therefore, each component must be ordered separately in order to build the proper terminal housing for your specific manufacturer.

#### General Information

- 1) Any other number/letter variations which may be stamped on your balance should first be discussed with your representative to ensure that your order will be filled correctly.
- 2) Balance prices include attached bracket

#### END BRACKETS

Add suffix to complete part number.  
Must choose end to be attached directly to cord.

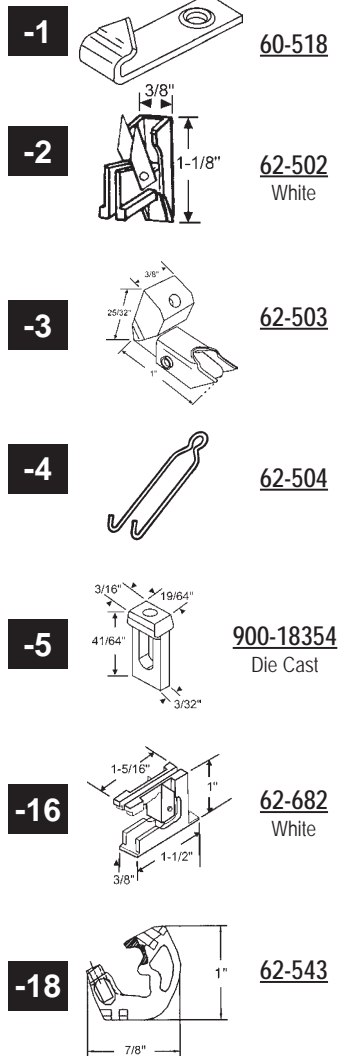

Balance Length	Number Stamped on Balance	Weight Range	Our Part Number	Balance Length	Number Stamped on Balance	Weight Range	Our Part Number
13"	1210	3-8	62-121-	21"	20DS	- 40	see instructions 4 and 6
13"	1220	8-11	62-122-	22"	2110	5-9	62-211-
13"	1230	11-13	62-123-	22"	2120	9-13	62-212-
13"	1240	13-17	62-124-	22"	2130	13-17	62-213-
13"	1290	- 20	see instructions 5 and 6	22"	2140	17-25	62-214-
14"	1310	4-8	62-131-	22"	2190	- 30	see instructions 5 and 6
14"	1320	8-11	62-132-	22"	21DS	- 40	see instructions 4 and 6
14"	1330	11-13	62-133-	23"	2210	5-9	62-221-
14"	1340	13-17	62-134-	23"	2220	9-14	62-222-
14"	1390	- 20	see instructions 5 and 6	23"	2230	14-18	62-223-
15"	1410	4-7	62-141-	23"	2240	18-26	62-224-
15"	1420	7-11	62-142-	23"	2290	- 30	see instructions 5 and 6
15"	1430	11-14	62-143-	23"	22DS	- 40	see instructions 4 and 6
15"	1440	14-20	62-144-	24"	2310	5-10	62-231-
15"	1490	- 20	see instructions 5 and 6	24"	2320	10-16	62-232-
16"	1510	4-7	62-151-	24"	2330	16-20	62-233-
16"	1520	7-11	62-152-	24"	2340	20-27	62-234-
16"	1530	11-14	62-153-	24"	2390	- 30	see instructions 5 and 6
16"	1540	14-20	62-154-	24"	23DS	- 40	see instructions 4 and 6
16"	1590	- 20	see instructions 5 and 6	25"	2410	5-10	62-241-
17"	1610	4-8	62-161-	25"	2420	10-16	62-242-
17"	1620	8-11	62-162-	25"	2430	16-20	62-244-
17"	1630	11-14	62-163-	25"	2440	20-27	62-245-
17"	1640	14-20	62-164-	25"	2490	- 30	see instructions 5 and 6
17"	1690	- 25	see instructions 5 and 6	25"	24DS	- 45	see instructions 4 and 6
17"	16DS	- 35	see instructions 4 and 6	26"	2510	5-10	62-251-
18"	1710	4-8	62-171-	26"	2520	10-15	62-252-
18"	1720	8-11	62-172-	26"	2530	15-20	62-253-
18"	1730	11-14	62-173-	26"	2540	20-27	62-254-
18"	1740	14-20	62-174-	26"	2590	- 30	see instructions 5 and 6
18"	1790	- 25	see instructions 5 and 6	26"	25DS	- 45	see instructions 4 and 6
18"	17DS	- 35	see instructions 4 and 6	27"	2610	5-10	62-261-
19"	1810	4-8	62-181-	27"	2620	10-16	62-262-
19"	1820	8-11	62-182-	27"	2630	16-20	62-263-
19"	1830	11-14	62-183-	27"	2640	20-27	62-264-
19"	1840	14-20	62-184-	27"	2690	- 30	see instructions 5 and 6
19"	1890	- 25	see instructions 5 and 6	27"	26DS	- 45	see instructions 4 and 6
19"	18DS	- 35	see instructions 4 and 6	28"	2710	5-10	62-271-
20"	1910	4-7	62-191-	28"	2720	10-16	62-272-
20"	1920	7-11	62-192-	28"	2730	16-20	62-273-
20"	1930	11-14	62-193-	28"	2740	20-27	62-274-
20"	1940	14-20	62-194-	28"	2790	- 30	see instructions 5 and 6
20"	1990	- 30	see instructions 5 and 6	28"	27DS	- 45	see instructions 4 and 6
20"	19DS	- 40	see instructions 4 and 6	29"	2810	7-13	62-281-
21"	2010	4-8	62-201-	29"	2820	13-17	62-282-
21"	2020	8-13	62-202-	29"	2830	17-24	62-283-
21"	2030	13-17	62-203-	29"	2840	24-30	62-284-
21"	2040	17-25	62-204-	29"	2850	30-36	62-285-
21"	2090	- 30	see instructions 5 and 6	29"	2890	- 35	62-285-

Continued on next page

Continued from previous page.

Balance Length	Number Stamped on Balance	Weight Range	Our Part Number
29"	28DS	- 45	see instructions 4 and 6
30"	2910	8-13	62-291-
30"	2920	13-17	62-293-
30"	2930	17-24	62-293-
30"	2940	24-30	62-294-
30"	2950	30-36	62-295-
30"	2990	- 35	62-295-
30"	29DS	- 45	see instructions 4 and 6
31"	3010	8-13	62-301-
31"	3020	13-18	62-302-
31"	3030	18-24	62-303-
31"	3040	24-30	62-304-
31"	3050	30-36	62-305-
31"	3090	- 35	62-305-
31"	30DS	- 45	see instructions 4 and 6
32"	3110	8-13	62-311-
32"	3120	13-17	62-312-
32"	3130	17-24	62-313-
32"	3140	24-30	62-314-
32"	3150	30-36	62-315-
32"	3190	- 35	62-315-
32"	31DS	- 45	see instructions 4 and 6
33"	3210	8-14	62-321-
33"	3220	14-19	62-322-
33"	3230	19-24	62-323-
33"	3240	24-30	62-324-
33"	3250	30-36	62-325-
33"	3290	- 35	62-325-
33"	32DS	- 45	see instructions 4 and 6
34"	3310	9-15	62-331-
34"	3320	15-19	62-332-
34"	3330	19-23	62-333-
34"	3340	23-30	62-334-
34"	3350	30-36	62-335-
34"	3390	- 35	62-335-
34"	33DS	- 45	see instructions 4 and 6
35"	3410	9-15	62-341-
35"	3420	15-19	62-342-
35"	3430	19-25	62-343-
35"	3440	25-30	62-344-
35"	3450	30-36	62-345-
35"	3490	- 35	62-345-
35"	34DS	- 45	see instructions 4 and 6
36"	3510	9-15	62-351-
36"	3520	15-19	62-352-
36"	3530	19-25	62-353-
36"	3540	25-30	62-354-
36"	3550	30-36	62-355-
36"	35DS	- 45	see instructions 4 and 6
37"	3610	9-15	62-361-
37"	3620	15-19	62-362-
37"	3630	19-25	62-363-
37"	3640	25-32	62-364-
37"	3650	32-38	62-365-
37"	36DS	- 45	see instructions 4 and 6
38"	3710	9-15	62-371-
38"	3720	15-19	62-372-
38"	3730	19-25	62-373-
38"	3740	25-32	62-374-
38"	3750	32-38	62-375-
38"	37DS	- 45	see instructions 4 and 6
39"	3810	9-15	62-381-
39"	3820	15-20	62-382-
39"	3830	20-25	62-383-
39"	3840	28-32	62-384-
39"	3850	32-38	62-385-
39"	38DS	- 45	see instructions 4 and 6
40"	3910	9-15	62-391-
40"	3920	15-20	62-392-
40"	3930	20-25	62-393-
40"	3940	25-32	62-394-
40"	3950	32-38	62-395-
40"	39DS	- 45	see instructions 4 and 6
41"	4010	9-15	62-401-
41"	4020	15-20	62-402-
41"	4030	20-25	62-403-
41"	4040	25-32	62-404-
41"	4050	32-38	62-405-
41"	40DS	- 45	see instructions 4 and 6
42"	4110	9-16	62-411-
42"	4120	16-20	62-412-
42"	4130	20-25	62-413-
42"	4140	25-32	62-414-
42"	4150	32-38	62-415-
42"	41DS	- 45	see instructions 4 and 6
43"	4210	9-16	62-421-
43"	4220	16-20	62-422-
43"	4230	20-26	62-423-

Balance Length	Number Stamped on Balance	Weight Range	Our Part Number
43"	4240	26-32	62-424-
43"	4250	32-38	62-425-
43"	42DS	- 45	see instructions 4 and 6
44"	4310	9-15	62-431-
44"	4320	15-20	62-432-
44"	4330	20-26	62-433-
44"	4340	26-32	62-434-
44"	4350	32-38	62-435-
44"	43DS	- 45	see instructions 4 and 6
45"	4410	9-15	62-441-
45"	4420	15-20	62-442-
45"	4430	20-26	62-443-
45"	4440	26-32	62-444-
45"	4450	32-38	62-445-
45"	44DS	- 45	see instructions 4 and 6
46"	4510	9-15	62-451-
46"	4520	15-20	62-452-
46"	4530	20-26	62-453-
46"	4540	26-32	62-454-
46"	4550	32-40	62-455-
46"	45DS	- 45	see instructions 4 and 6
47"	4610	9-15	62-461-
47"	4620	15-20	62-462-
47"	4630	20-26	62-463-
47"	4640	26-32	62-464-
47"	4650	32-40	62-465-
47"	46DS	- 45	see instructions 4 and 6
48"	4710	9-15	62-471-
48"	4720	15-20	62-472-
48"	4730	20-26	62-473-
48"	4740	26-32	62-474-
48"	4750	32-40	62-475-
48"	47DS	- 45	see instructions 4 and 6
49"	4810	9-15	62-481-
49"	4820	15-21	62-482-
49"	4830	21-26	62-483-
49"	4840	26-32	62-484-
49"	4850	32-40	62-485-
49"	48DS	- 45	see instructions 4 and 6
50"	4910	9-15	62-491-
50"	4920	15-20	62-492-
50"	4930	20-26	62-493-
50"	4940	26-32	62-494-
50"	4950	32-40	62-495-
50"	49DS	- 45	see instructions 4 and 6
51"	5010	9-15	62-501-
51"	5020	15-20	62-502-
51"	5030	20-26	62-503-
51"	5040	26-32	62-504-
51"	5050	32-40	62-505-
51"	50DS	- 45	see instructions 4 and 6
52"	5110	9-15	62-511-
52"	5120	15-21	62-512-
52"	5130	21-26	62-513-
52"	5140	26-32	62-514-
52"	5150	32-40	62-515-
52"	51DS	- 45	see instructions 4 and 6
53"	5210	9-15	62-521-
53"	5220	15-20	62-522-
53"	5230	20-26	62-523-
53"	5240	26-32	62-524-
53"	5250	32-40	62-525-
53"	52DS	- 45	see instructions 4 and 6
54"	5310	9-15	62-531-
54"	5320	15-20	62-532-
54"	5330	20-26	62-533-
54"	5340	26-32	62-534-
54"	5350	32-40	62-535-
54"	53DS	- 45	see instructions 4 and 6

## 62A SERIES BALANCES FOR JAMBLINERS

1/2" RIBBED CHANNEL BALANCE FOR JAMBLINERS COMMONLY REFERRED TO AS D70 BALANCES.

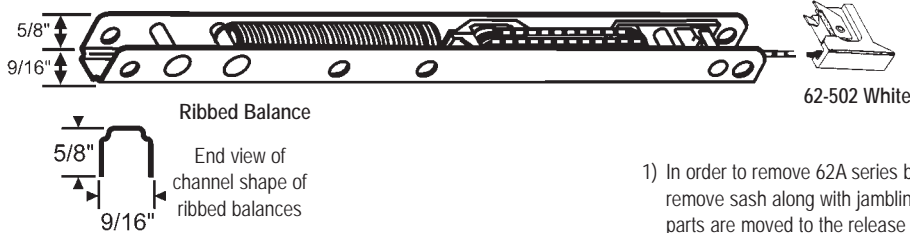

Ribbed Balance

End view of channel shape of ribbed balances

### General Information

- 1) In order to remove 62A series balances, you must first remove all window trim and remove sash along with jambliners. Balances can then be slid out of jambliner sleeve once parts are moved to the release position. (Forcing balances out of jambliner pocket will most likely destroy vinyl extrusion!)
- 2) Balances can be special ordered in beige or white finishes. Contact your account manager for part numbers.

### Ordering Information

- 1) Measure metal channel length. Do not include any attached ends.
- 2) Check number stamped on channel. (e.g. 16, 16HD, 16TG, etc.)
- 3) Select our corresponding part number from the chart below.
- 4) Identify the appropriate end bracket to be attached from illustration at right of chart. Select -2, -5, -9, -12, -14, -16, -17.
- 5) Note -2, -12 are available in white and black. White will automatically be attached to regular balances; black will automatically be attached to HD, TG and XHD balances.

Length of Metal Channel	Number Stamped on Balance	Weight Range	Our Part Number
13"	12L	5 - 8	62A-12L-
13"	12 or 12R	8 - 11	62A-12-
13"	12HD	11-14	62A-12HD-
13"	12TG or 12XHD or 12XH	14-17	62A-12TG-
14"	13L	5-8	62A-13L-
14"	13 or 13R	8-11	62A-13-
14"	13HD	11-14	62A-13HD-
14"	13TG or 13XHD or 13XH	14-17	62A-13TG-
15"	14L	6-10	62A-14L-
15"	14 or 14R	10-15	62A-14-
15"	14HD	15-22	62A-14HD-
15"	14TG or 14XHD or 14XH	22-24	62A-14TG-
16"	15L	6-10	62A-15L-
16"	15 or 15R	10-15	62A-15-
16"	15HD	15-22	62A-15HD-
16"	15TG or 15XHD or 15XH	22-24	62A-15TG-
17"	16L	6-10	62A-16L-
17"	16 or 16R	10-17	62A-16-
17"	16HD	17-22	62A-16HD-
17"	16TG or 16XHD or 16XH	22-24	62A-16TG-
18"	17L	6-10	62A-17L-
18"	17 or 17R	10-17	62A-17-
18"	17HD	17-22	62A-17HD-
18"	17TG or 17XHD or 17XH	22-24	62A-17TG-
19"	18L	6-10	62A-18L-
19"	18 or 18R	10-17	62A-18-
19"	18HD	17-22	62A-18HD-
19"	18TG or 18XHD or 18XH	22-24	62A-18TG-
20"	19L	6-10	62A-19L-
20"	19 or 19R	10-17	62A-19-
20"	19HD	17-22	62A-19HD-
20"	19TG or 19XHD or 19XH	22-24	62A-19TG-
21'	20L	6-10	62A-20L-
21'	20 or 20R	10-17	62A-20-
21'	20HD	17-20	62A-20HD-
21'	20TG or 20XHD or 20XH	20-30	62A-20TG-
22"	21L	6-10	62A-21L-
22"	21 or 21R	10-17	62A-21-
22"	21HD	17-20	62A-21HD-
22"	21TG or 21XHD or 21XH	20-30	62A-21TG-
23"	22L	6-10	62A-22L-

Continued on next page

## END BRACKETS

Add suffix to complete part number.

**-2**

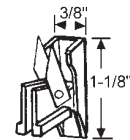

**62-511**  
Black

**-5**

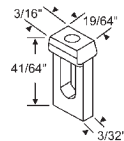

**900-18354**  
Die Cast

**-9**

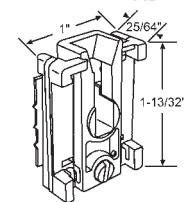

**62-530**  
w/Adjustment Screw

**-12**

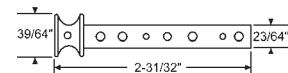

**62-520**  
White

**-14**

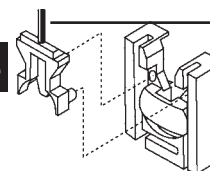

**62-528**  
Die Cast

**62-526**

Sold and Attached Separately

**-15**

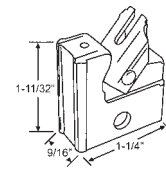

**62-531**  
Zinc Die Cast  
Magnum Locking Terminal

**-16**

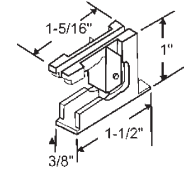

**62-682**  
White

**-17**

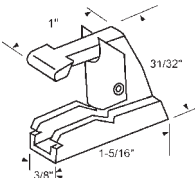

**62-684B**  
Black

Continued from previous page.

Length of Metal Channel	Number Stamped on Balance	Weight Range	Our Part Number	Length of Metal Channel	Number Stamped on Balance	Weight Range	Our Part Number
23"	22 or 22R	10-18	62A-22-	38"	37 or 37R	15-24	62A-37-
23"	22HD	18-22	62A-22HD-	38"	37HD	24-29	62A-37HD-
23"	22TG or 22XHD or 22XH	22-30	62A-22TG-	38"	37TG or 37XHD or 37XH	29-38	62A-37TG-
24"	23L	6-10	62A-23L-	39"	38L	10-15	62A-38L-
24"	23 or 23R	10-18	62A-23-	39"	38 or 38R	15-24	62A-38-
24"	23HD	18-22	62A-23HD-	39"	38HD	24-29	62A-38HD-
24"	23TG or 23XHD or 23XH	22-30	62A-23TG-	39"	38TG or 38XHD or 38XH	29-38	62A-38TG-
25"	24L	6-10	62A-24L-	40"	39L	10-15	62A-39L-
25"	24 or 24R	10-18	62A-24-	40"	39 or 39R	15-25	62A-39-
25"	24HD	18-22	62A-24HD-	40"	39HD	25-30	62A-39HD-
25"	24TG or 24XHD or 24XH	22-30	62A-24TG-	40"	39TG or 39XHD or 39XH	30-38	62A-39TG-
26"	25L	6-10	62A-25L-	41"	40L	10-15	62A-40L-
26"	25 or 25R	10-20	62A-25-	41"	40 or 40R	15-25	62A-40-
26"	25TG or 25XHD or 25XH	24-30	62A-25TG-	41"	40HD	25-30	62A-40HD-
27"	26L	6-10	62A-26L-	41"	40TG or 40XHD or 40XH	30-38	62A-40TG-
27"	26 or 26R	10-19	62A-26-	42"	41L	10-15	62A-41L-
27"	26HD	19-24	62A-26HD-	42"	41 or 41R	15-25	62-41-
27"	26TG or 26XHD or 26XH	24-31	62A-26TG-	42"	41HD	25-30	62A-41HD-
28"	27L	6-10	62A-27L-	42"	41TG or 41XHD or 41XH	30-38	62A-41TG-
28"	27 or 27R	10-19	62A-27-	43"	42L	10-15	62A-42L-
28"	27HD	19-24	62A-27HD-	43"	42 or 42R	15-25	62A-42-
28"	27TG or 27XHD or 27XH	24-31	62A-27TG-	43"	42HD	25-30	62A-42HD-
29"	28L	10-15	62A-28L-	43"	42TG or 42XHD or 42XH	30-38	62A-42TG-
29"	28 or 28R	15-22	62A-28-	44"	43L	10-15	62A-43L-
29"	28HD	22-28	62A-28HD-	44"	43 or 43R	15-25	62A-43-
29"	28TG or 28XHD or 28XH	28-35	62A-28TG-	44"	43HD	25-30	62A-43HD-
30"	29L	10-15	62A-29L-	44"	43TG or 43XHD or 43XH	30-38	62A-43TG-
30"	29 or 29R	15-22	62A-29-	45"	44L	10-15	62A-44L-
30"	29HD	22-28	62A-29HD-	45"	44 or 44R	15-25	62A-44-
30"	29TG or 29XHD or 29XH	28-35	62A-29TG-	45"	44HD	25-30	62A-44HD-
31"	30L	10-15	62A-30L-	45"	44TG or 44XHD or 44XH	30-38	62A-44TG-
31"	30 or 30R	15-23	62A-30-	46"	45L	10-15	62A-45L-
31"	30HD	23-29	62A-30HD-	46"	45 or 45R	15-25	62A-45-
31"	30TG or 30XHD or 30XH	29-36	62A-30TG-	46"	45HD	25-30	62A-45HD-
32"	31L	10-15	62A-31L-	46"	45TG or 45XHD or 45XH	30-38	62A-45TG-
32"	31 or 31R	15-23	62A-31-	47"	46L	10-15	62A-46L-
32"	31HD	23-29	62A-31HD-	47"	46 or 46R	15-25	62A-46-
32"	31TG or 31XHD or 31XH	29-36	62A-31TG-	47"	46HD	25-30	62A-46HD-
33"	32L	10-15	62A-32L-	47"	46TG or 46XHD or 46XH	30-38	62A-46TG-
33"	32 or 32R	15-24	62A-32-	48"	47L	10-15	62A-47L-
33"	32HD	24-29	62A-32HD-	48"	47 or 47R	15-25	62A-47-
33"	32TG or 32XHD or 32XH	29-36	62A-32TG-	48"	47HD	25-30	62A-47HD-
34"	33L	10-15	62A-33L-	48"	47TG or 47XHD or 47XH	30-38	62A-47TG-
34"	33 or 33R	15-24	62A-33-	49"	48L	10-15	62A-48L-
34"	33HD	24-29	62A-33HD-	49"	48 or 48R	15-25	62A-48-
34"	33TG or 33XHD or 33XH	29-36	62A-33TG-	49"	48HD	25-30	62A-48HD-
35"	34L	10-15	62A-34L-	49"	48TG or 48XHD or 48XH	30-38	62A-48TG-
35"	34 or 34R	15-24	62A-34-	50"	49L	10-15	62A-49L-
35"	34HD	24-29	62A-34HD-	50"	49 or 49R	15-25	62A-49-
35"	34TG or 34XHD or 34XH	29-36	62A-34TG-	50"	49HD	25-30	62A-49HD-
36"	35L	10-15	62A-35L-	50"	49TG or 49XHD or 49XH	30-38	62A-49TG-
36"	35 or 35R	15-24	62A-35-	51"	50L	10-15	62A-50L-
36"	35HD	24-29	62A-35HD-	51"	50 or 50R	15-25	62A-50-
36"	35TG or 35XHD or 35XH	29-36	62A-35TG-	51"	50HD	25-30	62A-50HD-
37"	36L	10-15	62A-36L-	51"	50TG or 50XHD or 50XH	30-38	62A-50TG-
37"	36 or 36R	15-24	62A-36-	52"	51L	10-15	62A-51L-
37"	36HD	24-29	62A-36HD-	52"	51 or 51R	15-25	62A-51-
37"	36TG or 36XHD or 36XH	29-38	62A-36TG-	52"	51HD	25-30	62A-51HD-
38"	37L	10-15	62A-37L-	52"	51TG or 51XHD or 51XH	30-38	62A-51TG-



## 62 SERIES CHANNEL BALANCES ACCESSORIES

### BALANCE ATTACHMENTS

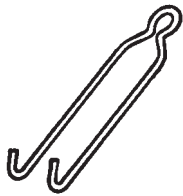

**62-504**

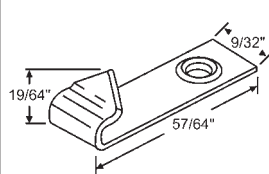

Part #	Description
60-518	1/32" Thick
60-518HD	3/64" Thick

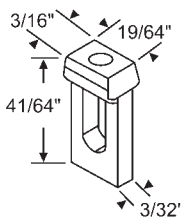

**900-18354**  
Die Cast

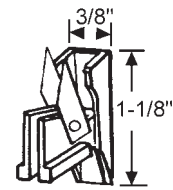

Part #	Color
62-502	White
62-511	Black

Locking Terminals  
Plastic with Metal Lock

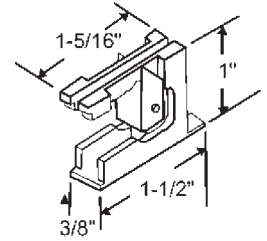

**62-682**

White. Locking Terminals  
Plastic with Metal Lock

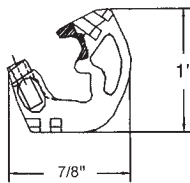

**62-543**

Wedge Locking Shoe  
Only Available Attached  
to Balance

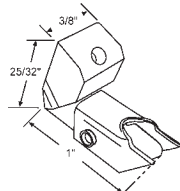

**62-503**

Locking Terminals  
Plastic with Metal Lock

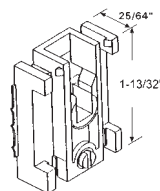

Part #	Color
62-530	White

Includes Adjustment Screw

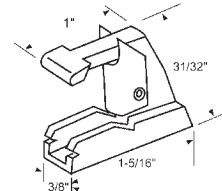

**62-684B**

Black

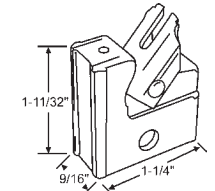

**62-531**

Zinc Die Cast  
Magnum Locking Terminal  
**WEATHERSHIELD**

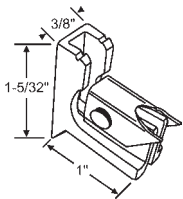

**62-502SP**

Locking Terminal Assembly  
White

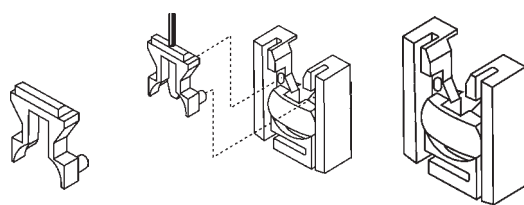

**62-528**

Die Cast

Tie Bar Guide

**62-526**

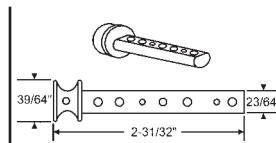

Part #	Color
62-520	White
62-521	Black

Plastic

### INVERTED BALANCE T-LOCKS

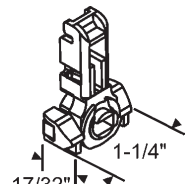

**62-50000**

w/ 1.30 Extension  
Red Puck Open Cam

### "S" CLIPS

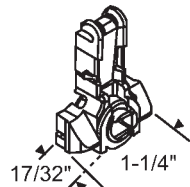

**62-50034**

T-Lock with Spring  
**LOCKHEED**

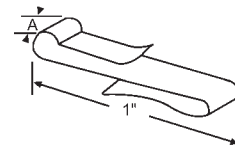

Part #	"A"
62-517	1/4"
62-517HD	3/8"

Short "S" Clip

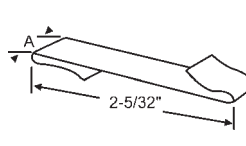

Part #	"A"
62-518	1/4"
62-518HD	3/8"

Long "S" Clip

### TERMINAL HOUSINGS

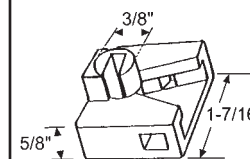

Part #	Hand	Use With
62-532	Shown	15/16" Cam
62-533	Opposite	15/16" Cam
62-535	Shown	5/8" Cam
62-534	Opposite	5/8" Cam

Housing Assembly.  
Includes Cam and Shoe  
**GRAHAM**

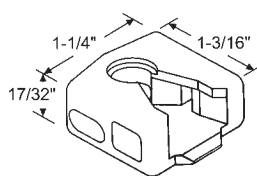

**62-512**

9/16" Dia. Hole  
**GRAHAM**

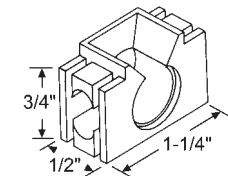

**62-505**

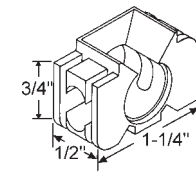

Part #	Hand
62-507	Shown
62-506	Opposite

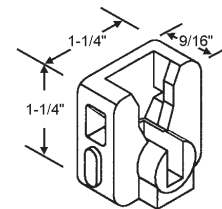

**900-9312A**

**GRAHAM**

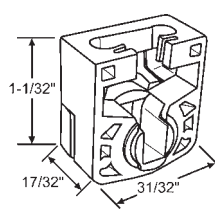

**62-834**

Front to Back 1"  
**SUPER SEAL**

# SASH SUPPORT SYSTEMS

## 62 SERIES CHANNEL BALANCES ACCESSORIES

### TERMINAL HOUSINGS

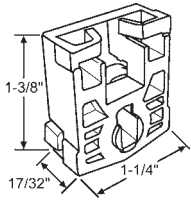

**62-831**

White Puck

**THERMAL INDUSTRIES**

### LOCKING CAMS

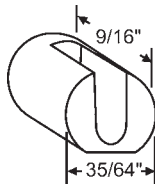

**62-509**

Die Cast

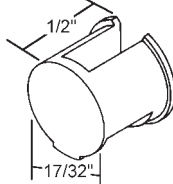

**62-513**

Die Cast

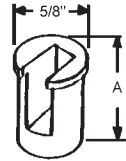

Part #	A
900-9447	15/16"
900-9447M	5/8"

Die Cast

**GRAHAM**

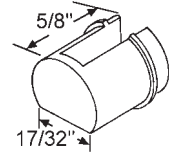

**62-516**

Die Cast

### PIVOT RETAINERS

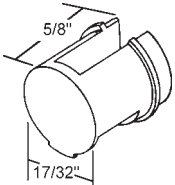

**62-514**

Die Cast

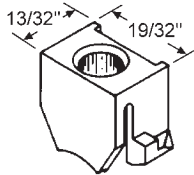

**62-519**

Die Cast

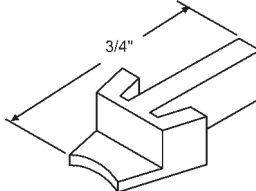

**62-660**

Non Take Out Retainer

### BRAKE SHOES

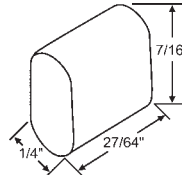

**62-510**

White

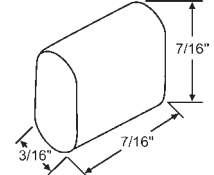

**900-9310**

Used with 62-532, 533, 534 & 535

**GRAHAM**

### PIVOT LOCK SHOES

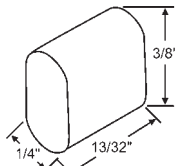

**62-614**

Black

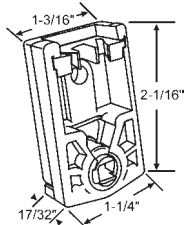

**62-565**

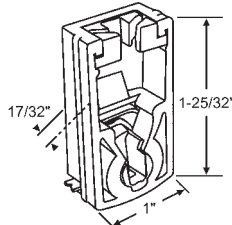

**62-546**

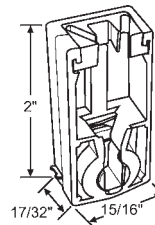

**62-698OS**

Metal Cam. Old Style

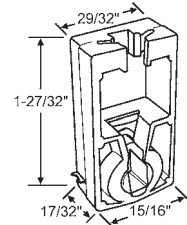

**62-698**

### OMEGA PIVOT LOCK SHOE

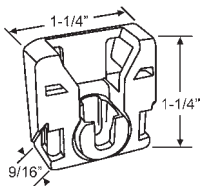

**62-595**

Pivot Lock Shoe with Slate Blue Puck

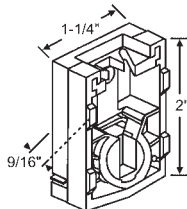

**62-695**

1.250" X .575" Metal .030" Spring Zinc Plate

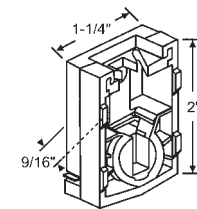

**62-679**

1.250" X .575" Metal Spring Zinc Plate

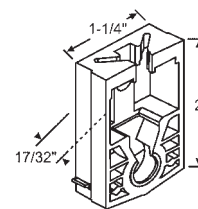

**62-693**

1.250" X .530" Metal Spring Molded Plate

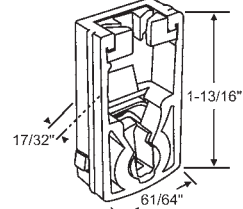

**62-568**

Molded Spring. Zinc Plate  
**GREAT LAKES**

### TILT STUDS

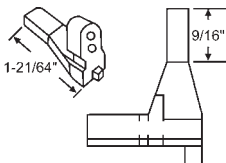

Part #	Hand
62-612	Shown
62-611	Opposite

Above item has Left/Right marked on part. Die Cast

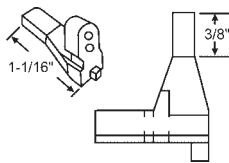

Part #	Hand
62-616	Shown
62-617	Opposite

Above item has Left/Right marked on part. Die Cast

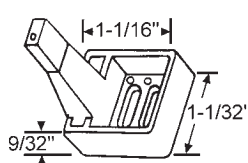

Part #	Hand
62-620	Shown
62-621	Opposite

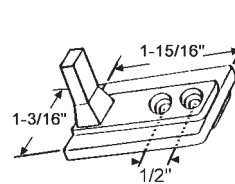

**900-9443**

Zinc

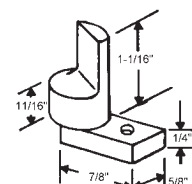

**62-622A**

Plastic Set

**REPCO**

## 62 SERIES CHANNEL BALANCES ACCESSORIES

### TILT STUDS

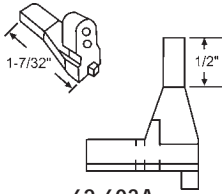

**62-603A**

LH & RH Set (LH Shown). Above item has Left/Right marked on part. Die Cast

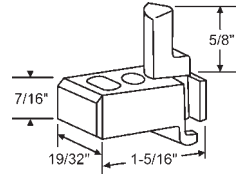

Part #	Hand
62-600	Shown
62-601	Opposite

Plastic

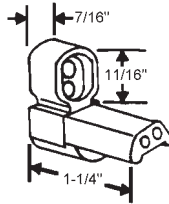

**62-602**  
Plastic

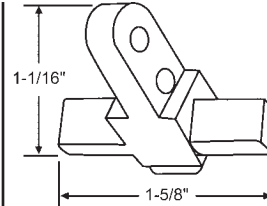

**62-663**  
Tilt Stud Dual Arm  
Die Cast

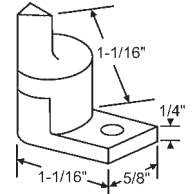

Part #	Hand
62-625	Shown
62-626	Opposite

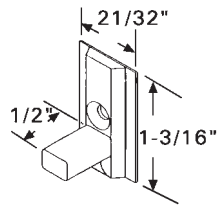

**62-654**

Die Cast  
Square Plough

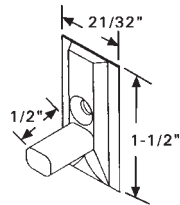

**62-652**

Die Cast  
Square Plough

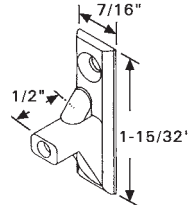

**62-653**

Die Cast  
V Plough

### CAM PIVOTS

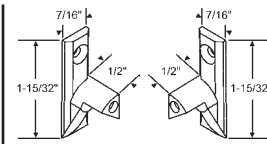

Part #	Hand	Description
62-649LW	LH	Natural Plastic
62-649RB	RH	Black Plastic
62-650RH	RH	Zinc
62-650LH	LH	Zinc

### PIVOT BARS

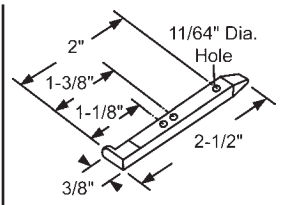

**62-540F**

Die Cast

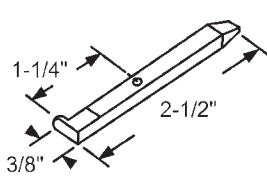

**62-540**

Non-Pull-Out. Die Cast

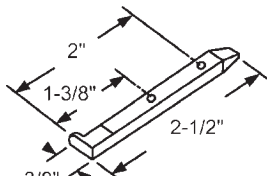

**62-540A**

Die Cast

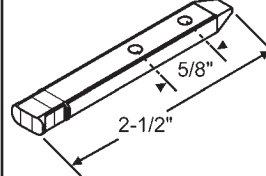

**62-550**

T-Head Pivot Bar Zinc

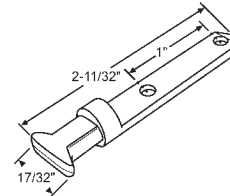

**62-833**

Die Cast  
**REPUBLIC**

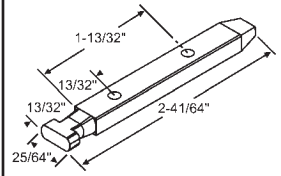

**62-828**

T-Head Pivot Bar  
**SIMONTON**

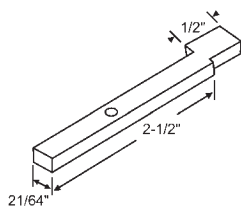

**62-624**

Die Cast

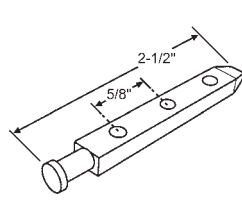

**62-541**

Zinc

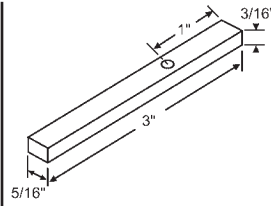

Part #	Description
900-14396	No Thread, Die Cast
900-13506	With Thread, Stainless Steel

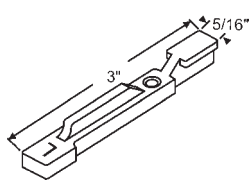

Part #	Hand
62-618	Shown
62-619	Opposite

Die Cast

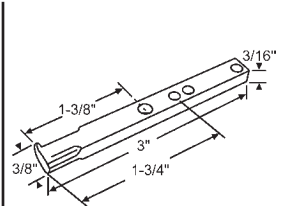

**62-545**

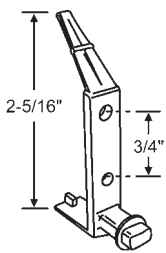

**62-711**

Pivot Bar Die cast  
**HARVEY**

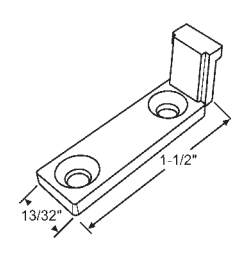

**62-832**

**SCHERER**

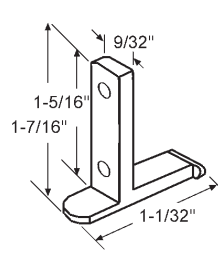

**900-21862A**

LH (shown). Sold in Sets Only  
Die Cast

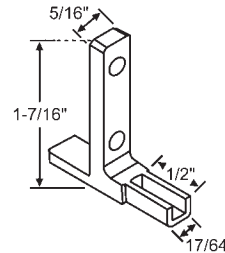

**900-22082**

Zinc. Die Cast  
**REHAUF**

### SASH RETAINERS

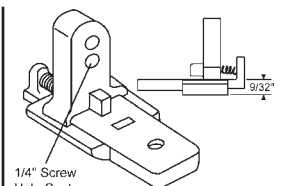

1/4" Screw  
Hole Centers

Part #	Color
62-605	White
62-615	Black

# SASH SUPPORT SYSTEMS

## 62 SERIES CHANNEL BALANCES ACCESSORIES

### SASH RETAINERS

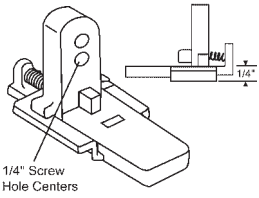

1/4" Screw Hole Centers

**62-610**

Black

Used with 62-602 and 62-501  
**NORANDEX**

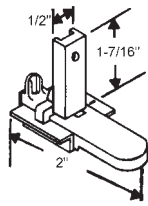

No Longer Available

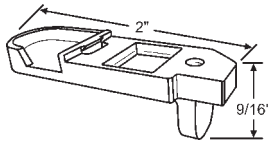

Part #	Hand
62-639	Shown
62-640	Opposite

Nylon Slide Only  
For 62-636 & 62-637.

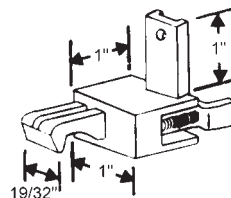

Part #	Hand
62-607	Shown
62-606	Opposite

**HOWMET**

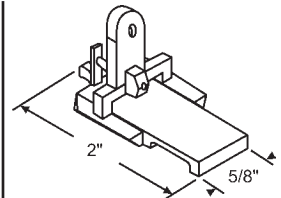

Part #	Hand
62-644	Shown
62-645	Opposite

Clear Plastic

### SASH STOPS

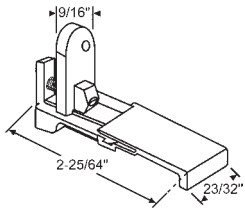

No Longer Available

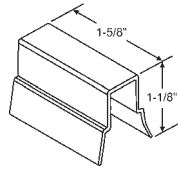

Part #	Color
62-702	White
62-702BG	Beige

Vinyl

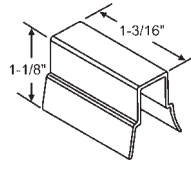

Part #	Color
62-701BG	Beige
62-701	White

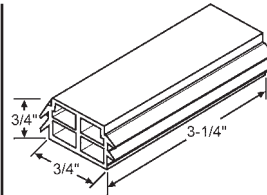

**900-19369**

Black Rubber Sash Stop

### SASH LOCK

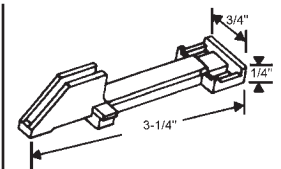

**62-633**

Lower  
Nylon

### BUSHINGS

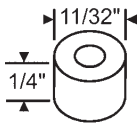

**62-613**

**KELLER**

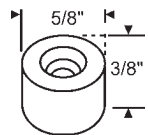

**62-658**

Metal, Mill Finish

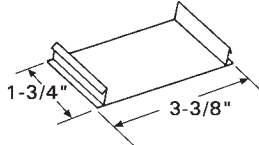

**86-21**

Vinyl Release

### INSTALLATION BRACKETS

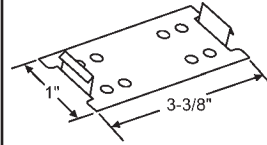

**86-22**

Metal

### RELEASE LEVER

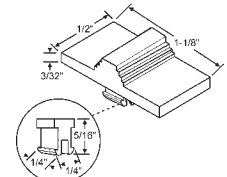

Part #	Color
62-643BR	Brown
62-643BG	Beige
62-643	White
62-643BL	Black

### GUIDE

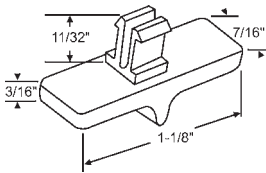

Part #	Finish
62-635	Natural
62-635B	Black

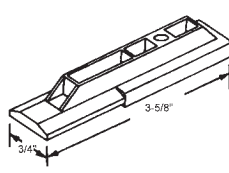

**900-11376**

**GRAHAM**

### BALANCE STOP

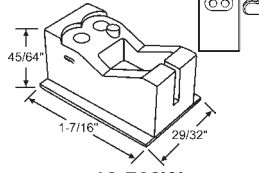

**62-708W**

White Balance Stop

**62-709W**

White Screw Cover

### INTERLOCKING PLUNGER

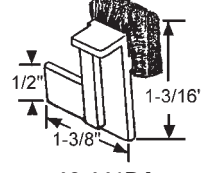

**62-641BA**

Black

Sold in Sets Only, RH Shown

**AIRMASTER**

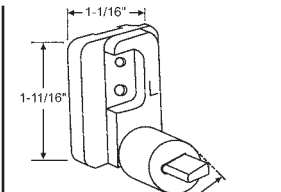

**900-20924A**

Pivot Assy. Set (LH Shown & Opposite)

## 64T SERIES TILT CHANNEL BALANCES ACCESSORIES

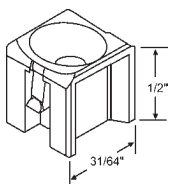

**62-689**

Mounting Screw Support

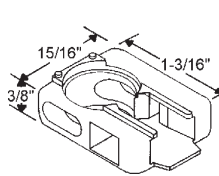

**64T-500**

Terminal Housing



**64T-503**

Brake Shoe



**64T-504**

Brake Shoe

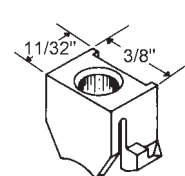

**64T-505**

Pivot Retainer

## 62-716 SERIES 1/2" X 1/2" INVERTED TILT CHANNEL BALANCES

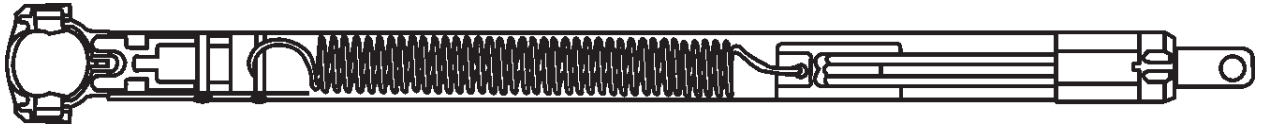

Length of Metal Channel	Number Stamped on Balance	Sash Weight	Our Part Number	Length of Metal Channel	Number Stamped on Balance	Sash Weight	Our Part Number	Length of Metal Channel	Number Stamped on Balance	Sash Weight	Our Part Number	Length of Metal Channel	Number Stamped on Balance	Sash Weight	Our Part Number
10"	10A	1-6 LBS.	62-716-10A-	22"	22D	21-24 LBS.	62-716-22D-	30"	30E	29-33 LBS.	62-716-30E-	38"	38B	16-22 LBS.	62-716-38B-
10"	10B	6-10 LBS.	62-716-10B-	22"	22E	24-27 LBS.	62-716-22E-	30"	30F	33-37 LBS.	62-716-30F-	38"	38C	22-27 LBS.	62-716-38C-
10"	10C	10-13LBS.	62-716-10C-	22"	22F	27-30 LBS.	62-716-22F-	30"	30G	37-40 LBS.	62-716-30G-	38"	38D	27-32 LBS.	62-716-38D-
11"	11A	3-7 LBS.	62-716-11A-	22"	22G	30-34 LBS.	62-716-22G-	30"	30H	40-43 LBS.	62-716-30H-	38"	38E	32-34 LBS.	62-716-38E-
11"	11B	7-10 LBS.	62-716-11B-	22"	22H	34-37 LBS.	62-716-22H-	31"	31A	8-13 LBS.	62-716-31A-	38"	38F	34-37 LBS.	62-716-38F-
11"	11C	10-16 LBS.	62-716-11C-	23"	23A	5-10 LBS.	62-716-23A-	31"	31B	13-19 LBS.	62-716-31B-	38"	38G	37-40 LBS.	62-716-38G-
12"	12A	3-7 LBS.	62-716-12A-	23"	23B	10-16 LBS.	62-716-23B-	31"	31C	19-24 LBS.	62-716-31C-	38"	38H	40-43 LBS.	62-716-38H-
12"	12B	7-10 LBS.	62-716-12B-	23"	23C	16-21 LBS.	62-716-23C-	31"	31D	24-29 LBS.	62-716-31D-	38"	38I	43-45 LBS.	62-716-38I-
12"	12C	10-16 LBS.	62-716-12C-	23"	23D	21-24 LBS.	62-716-23D-	31"	31E	29-33 LBS.	62-716-31E-	39"	39A	11-16 LBS.	62-716-39A-
12"	12D	16-18 LBS.	62-716-12D-	23"	23E	24-27 LBS.	62-716-23E-	31"	31F	33-37 LBS.	62-716-31F-	39"	39B	16-22 LBS.	62-716-39B-
13"	13A	3-7 LBS.	62-716-13A-	23"	23F	27-30 LBS.	62-716-23F-	31"	31G	37-40 LBS.	62-716-31G-	39"	39C	22-27 LBS.	62-716-39C-
13"	13B	7-10 LBS.	62-716-13B-	23"	23G	30-34 LBS.	62-716-23G-	31"	31H	40-43 LBS.	62-716-31H-	39"	39D	27-32 LBS.	62-716-39D-
13"	13C	10-16 LBS.	62-716-13C-	23"	23H	34-37 LBS.	62-716-23H-	32"	32A	8-14 LBS.	62-716-32A-	39"	39E	32-34 LBS.	62-716-39E-
13"	13D	16-18 LBS.	62-716-13D-	24"	24A	6-11 LBS.	62-716-24A-	32"	32B	14-20 LBS.	62-716-32B-	39"	39F	34-37 LBS.	62-716-39F-
14"	14A	3-7 LBS.	62-716-14A-	24"	24B	11-17 LBS.	62-716-24B-	32"	32C	20-25 LBS.	62-716-32C-	39"	39G	37-40 LBS.	62-716-39G-
14"	14B	7-10 LBS.	62-716-14B-	24"	24C	17-22 LBS.	62-716-24C-	32"	32D	25-30 LBS.	62-716-32D-	39"	39H	40-43 LBS.	62-716-39H-
14"	14C	10-16 LBS.	62-716-14C-	24"	24D	22-25 LBS.	62-716-24D-	32"	32E	30-34 LBS.	62-716-32E-	39"	39I	43-45 LBS.	62-716-39I-
14"	14D	16-19 LBS.	62-716-14D-	24"	24E	25-28 LBS.	62-716-24E-	32"	32F	34-37 LBS.	62-716-32F-	40"	40A	11-16 LBS.	62-716-40A-
15"	15A	3-7 LBS.	62-716-15A-	24"	24F	28-30 LBS.	62-716-24F-	32"	32G	37-40 LBS.	62-716-32G-	40"	40B	16-22 LBS.	62-716-40B-
15"	15B	7-10 LBS.	62-716-15B-	24"	24G	30-34 LBS.	62-716-24G-	32"	32H	40-43 LBS.	62-716-32H-	40"	40C	22-27 LBS.	62-716-40C-
15"	15C	10-16 LBS.	62-716-15C-	24"	24H	34-37 LBS.	62-716-24H-	33"	33A	8-14 LBS.	62-716-33A-	40"	40D	27-32 LBS.	62-716-40D-
15"	15D	16-19 LBS.	62-716-15D-	25"	25A	6-11 LBS.	62-716-25A-	33"	33B	14-20 LBS.	62-716-33B-	40"	40E	32-34 LBS.	62-716-40E-
16"	16A	3-7 LBS.	62-716-16A-	25"	25B	11-17 LBS.	62-716-25B-	33"	33C	20-25 LBS.	62-716-33C-	40"	40F	34-37 LBS.	62-716-40F-
16"	16B	7-10 LBS.	62-716-16B-	25"	25C	17-22 LBS.	62-716-25C-	33"	33D	25-30 LBS.	62-716-33D-	40"	40G	37-40 LBS.	62-716-40G-
16"	16C	10-16 LBS.	62-716-16C-	25"	25D	22-25 LBS.	62-716-25D-	33"	33E	30-34 LBS.	62-716-33E-	40"	40H	40-43 LBS.	62-716-40H-
16"	16D	16-19 LBS.	62-716-16D-	25"	25E	25-28 LBS.	62-716-25E-	33"	33F	34-37 LBS.	62-716-33F-	40"	40I	43-45 LBS.	62-716-40I-
16"	16E	19-22 LBS.	62-716-16E-	25"	25F	28-30 LBS.	62-716-25F-	33"	33G	37-40 LBS.	62-716-33G-	41"	41A	11-16 LBS.	62-716-41A-
17"	17A	3-7 LBS.	62-716-17A-	25"	25G	30-34 LBS.	62-716-25G-	33"	33H	40-43 LBS.	62-716-33H-	41"	41B	16-22 LBS.	62-716-41B-
17"	17B	7-10 LBS.	62-716-17B-	25"	25H	34-37 LBS.	62-716-25H-	34"	34A	11-16 LBS.	62-716-34A-	41"	41C	22-27 LBS.	62-716-41C-
17"	17C	10-16 LBS.	62-716-17C-	26"	26A	6-11 LBS.	62-716-26A-	34"	34B	16-22 LBS.	62-716-34B-	41"	41D	27-32 LBS.	62-716-41D-
17"	17D	16-19 LBS.	62-716-17D-	26"	26B	11-17 LBS.	62-716-26B-	34"	34C	22-27 LBS.	62-716-34C-	41"	41E	32-34 LBS.	62-716-41E-
17"	17E	19-22 LBS.	62-716-17E-	26"	26C	17-22 LBS.	62-716-26C-	34"	34D	27-32 LBS.	62-716-34D-	41"	41F	34-37 LBS.	62-716-41F-
17"	17F	22-24 LBS.	62-716-17F-	26"	26D	22-26 LBS.	62-716-26D-	34"	34E	32-34 LBS.	62-716-34E-	41"	41G	37-40 LBS.	62-716-41G-
17"	17G	24-28 LBS.	62-716-17G-	26"	26E	26-30 LBS.	62-716-26E-	34"	34F	34-37 LBS.	62-716-34F-	41"	41H	40-43 LBS.	62-716-41H-
18"	18A	4-9 LBS.	62-716-18A-	26"	26F	30-34 LBS.	62-716-26F-	34"	34G	37-40 LBS.	62-716-34G-	41"	41I	43-45 LBS.	62-716-41I-
18"	18B	9-13 LBS.	62-716-18B-	26"	26G	34-38 LBS.	62-716-26G-	34"	34H	40-43 LBS.	62-716-34H-	42"	42A	11-16 LBS.	62-716-42A-
18"	18C	13-18 LBS.	62-716-18C-	26"	26H	38-42 LBS.	62-716-26H-	34"	34I	43-45 LBS.	62-716-34I-	42"	42B	16-22 LBS.	62-716-42B-
18"	18D	18-21 LBS.	62-716-18D-	27"	27A	6-11 LBS.	62-716-27A-	35"	35A	11-16 LBS.	62-716-35A-	42"	42C	22-27 LBS.	62-716-42C-
18"	18E	21-24 LBS.	62-716-18E-	27"	27B	11-17 LBS.	62-716-27B-	35"	35B	16-22 LBS.	62-716-35B-	42"	42D	27-32 LBS.	62-716-42D-
18"	18F	24-26 LBS.	62-716-18F-	27"	27C	17-22 LBS.	62-716-27C-	35"	35C	22-27 LBS.	62-716-35C-	42"	42E	32-34 LBS.	62-716-42E-
18"	18G	26-29 LBS.	62-716-18G-	27"	27D	22-26 LBS.	62-716-27D-	35"	35D	27-32 LBS.	62-716-35D-	42"	42F	34-37 LBS.	62-716-42F-
19"	19A	4-9 LBS.	62-716-19A-	27"	27E	26-30 LBS.	62-716-27E-	35"	35E	32-34 LBS.	62-716-35E-	42"	42G	37-40 LBS.	62-716-42G-
19"	19B	9-13 LBS.	62-716-19B-	27"	27F	30-34 LBS.	62-716-27F-	35"	35F	34-37 LBS.	62-716-35F-	42"	42H	40-43 LBS.	62-716-42H-
19"	19C	13-18 LBS.	62-716-19C-	27"	27G	34-38 LBS.	62-716-27G-	35"	35G	37-40 LBS.	62-716-35G-	42"	42I	43-45 LBS.	62-716-42I-
19"	19D	18-21 LBS.	62-716-19D-	27"	27H	38-42 LBS.	62-716-27H-	35"	35H	40-43 LBS.	62-716-35H-	43"	43A	11-16 LBS.	62-716-43A-
19"	19E	21-24 LBS.	62-716-19E-	28"	28A	7-12 LBS.	62-716-28A-	35"	35I	43-45 LBS.	62-716-35I-	43"	43B	16-22 LBS.	62-716-43B-
19"	19F	24-26 LBS.	62-716-19F-	28"	28B	12-18 LBS.	62-716-28B-	36"	36A	11-16 LBS.	62-716-36A-	43"	43C	22-27 LBS.	62-716-43C-
19"	19G	26-29 LBS.	62-716-19G-	28"	28C	18-23 LBS.	62-716-28C-	36"	36B	16-22 LBS.	62-716-36B-	43"	43D	27-32 LBS.	62-716-43D-
20"	20A	5-10 LBS.	62-716-20A-	28"	28D	23-28 LBS.	62-716-28D-	36"	36C	22-27 LBS.	62-716-36C-	43"	43E	32-34 LBS.	62-716-43E-
20"	20B	10-14 LBS.	62-716-20B-	28"	28E	28-32 LBS.	62-716-28E-	36"	36D	27-32 LBS.	62-716-36D-	43"	43F	34-37 LBS.	62-716-43F-
20"	20C	14-18 LBS.	62-716-20C-	28"	28F	32-36 LBS.	62-716-28F-	36"	36E	32-34 LBS.	62-716-36E-	43"	43G	37-40 LBS.	62-716-43G-
20"	20D	18-22 LBS.	62-716-20D-	28"	28G	36-40 LBS.	62-716-28G-	36"	36F	34-37 LBS.	62-716-36F-	43"	43H	40-43 LBS.	62-716-43H-
20"	20E	22-26 LBS.	62-716-20E-	28"	28H	40-43 LBS.	62-716-28H-	36"	36G	37-40 LBS.	62-716-36G-	43"	43I	43-45 LBS.	62-716-43I-
20"	20F	26-30 LBS.	62-716-20F-	29"	29A	7-12 LBS.	62-716-29A-	36"	36H	40-43 LBS.	62-716-36H-	44"	44A	11-16 LBS.	62-716-44A-
20"	20G	30-34 LBS.	62-716-20G-	29"	29B	12-18 LBS.	62-716-29B-	36"	36I	43-45 LBS.	62-716-36I-	44"	44B	16-22 LBS.	62-716-44B-
21"	21A	5-10 LBS.	62-716-21A-	29"	29C	18-23 LBS.	62-716-29C-	37"	37A	11-16 LBS.	62-716-37A-	44"	44C	22-27 LBS.	62-716-44C-
21"	21B	10-14 LBS.	62-716-21B-	29"	29D	23-28 LBS.	62-716-29D-	37"	37B	16-22 LBS.	62-716-37B-	44"	44D	27-32 LBS.	62-716-44D-
21"	21C	14-18 LBS.	62-716-21C-	29"	29E	28-32 LBS.	62-716-29E-	37"	37C	22-27 LBS.	62-716-37C-	44"	44E	32-34 LBS.	62-716-44E-
21"	21D	18-22 LBS.	62-716-21D-	29"	29F	32-36 LBS.	62-716-29F-	37"	37D	27-32 LBS.	62-716-37D-	44"	44F	34-37 LBS.	62-716-44F-
21"	21E	22-26 LBS.	62-716-21E-	29"	29G	36-40 LBS.	62-716-29G-	37"	37E	32-34 LBS.	62-716-37E-	44"	44G	37-40 LBS.	62-716-44G-
21"	21F	26-30 LBS.	62-716-21F-	29"	29H	40-43 LBS.	62-716-29H-	37"	37F	34-37 LBS.	62-716-37F-	44"	44H	40-43 LBS.	62-716-44H-
21"	21G	30-34 LBS.	62-716-21G-	30"	30A	8-13 LBS.	62-716-30A-	37"	37G	37-40 LBS.	62-716-37G-	44"	44I	43-45 LBS.	62-716-44I-
22"	22A	5-10 LBS.	62-716-22A-	30"	30B	13-19 LBS.	62-716-30B-	37"	37H	40-43 LBS.	62-716-37H-				
22"	22B	10-16 LBS.	62-716-22B-	30"	30C	19-24 LBS.	62-716-30C-	37"	37I	43-45 LBS.	62-716-37I-				
22"	22C	16-21 LBS.	62-716-22C-	30"	30D	24-29 LBS.	62-716-30D-	38"	38A	11-16 LBS.	62-716-38A-				

See Next Page for Ordering Instructions

# SASH SUPPORT SYSTEMS

## 62-766 SERIES 1/2" X 1/2" INVERTED TILT CHANNEL BALANCE

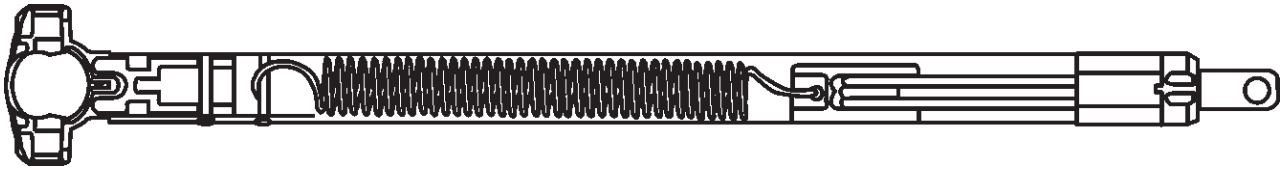

For Windows 36" or Less				For Windows Wider than 36"			
Length of Metal Channel	Number Stamped on Balance	Sash Weight	Our Part Number	Length of Metal Channel	Number Stamped on Balance	Sash Weight	Our Part Number
9"	900	3-10 LBS.	62-766-900-	9"	901	10-11 LBS.	62-766-901-
10"	1000	3-10 LBS.	62-766-1000-	10"	1001	10-11 LBS.	62-766-1001-
11"	1100	3-10 LBS.	62-766-1100-	11"	1101	10-11 LBS.	62-766-1101-
12"	1200	3-11 LBS.	62-766-1200-	12"	1201	11-13 LBS.	62-766-1201-
13"	1300	3-11 LBS.	62-766-1300-	13"	1301	11-13 LBS.	62-766-1301-
14"	1400	4-12 LBS.	62-766-1400-	14"	1401	12-15 LBS.	62-766-1401-
15"	1500	4-12 LBS.	62-766-1500-	15"	1501	12-15 LBS.	62-766-1501-
16"	1600	4-13 LBS.	62-766-1600-	16"	1601	13-16 LBS.	62-766-1601-
17"	1700	4-13 LBS.	62-766-1700-	17"	1701	13-16 LBS.	62-766-1701-
18"	1800	5-14 LBS.	62-766-1800-	18"	1801	14-18 LBS.	62-766-1801-
19"	1900	5-14 LBS.	62-766-1900-	19"	1901	14-18 LBS.	62-766-1901-
20"	2000	5-16 LBS.	62-766-2000-	20"	2001	16-19 LBS.	62-766-2001-
21"	2100	5-16 LBS.	62-766-2100-	21"	2101	16-19 LBS.	62-766-2101-
22"	2200	6-17 LBS.	62-766-2200-	22"	2201	17-21 LBS.	62-766-2201-
23"	2300	6-17 LBS.	62-766-2300-	23"	2301	17-21 LBS.	62-766-2301-
24"	2400	6-18 LBS.	62-766-2400-	24"	2401	18-23 LBS.	62-766-2401-
25"	2500	6-18 LBS.	62-766-2500-	25"	2501	18-23 LBS.	62-766-2501-
26"	2600	7-19 LBS.	62-766-2600-	26"	2601	19-24 LBS.	62-766-2601-
27"	2700	7-19 LBS.	62-766-2700-	27"	2701	19-24 LBS.	62-766-2701-
28"	2800	7-21 LBS.	62-766-2800-	28"	2801	21-26 LBS.	62-766-2801-
29"	2900	7-21 LBS.	62-766-2900-	29"	2901	21-26 LBS.	62-766-2901-
30"	3000	8-22 LBS.	62-766-3000-	30"	3001	22-28 LBS.	62-766-3001-
31"	3100	8-22 LBS.	62-766-3100-	31"	3101	22-28 LBS.	62-766-3101-
32"	3200	8-23 LBS.	62-766-3200-	32"	3201	23-29 LBS.	62-766-3201-
33"	3300	8-23 LBS.	62-766-3300-	33"	3301	23-29 LBS.	62-766-3301-
34"	3400	9-24 LBS.	62-766-3400-	34"	3401	24-31 LBS.	62-766-3401-
35"	3500	9-24 LBS.	62-766-3500-	35"	3501	24-31 LBS.	62-766-3501-
36"	3600	9-24 LBS.	62-766-3600-	36"	3601	25-32 LBS.	62-766-3601-
37"	3700	9-24 LBS.	62-766-3700-	37"	3701	25-32 LBS.	62-766-3701-
38"	3800	10-27 LBS.	62-766-3800-	38"	3801	27-33 LBS.	62-766-3801-
39"	3900	10-27 LBS.	62-766-3900-	39"	3901	27-33 LBS.	62-766-3901-
40"	4000	10-28 LBS.	62-766-4000-	40"	4001	28-34 LBS.	62-766-4001-
41"	4100	10-28 LBS.	62-766-4100-	41"	4101	28-34 LBS.	62-766-4101-
42"	4200	10-28 LBS.	62-766-4200-	42"	4201	28-34 LBS.	62-766-4201-
43"	4300	10-28 LBS.	62-766-4300-	43"	4301	28-34 LBS.	62-766-4301-
44"	4400	10-28 LBS.	62-766-4400-	44"	4401	28-34 LBS.	62-766-4401-

### ORDERING INSTRUCTIONS FOR 62-716 & 62-766

#### Ordering Information

- 1) Measure metal channel length (Do not include any attached ends.)
- 2) Check number stamped on channel: e.g., 23C, 29A etc.
- 3) Select our corresponding part number from chart on previous page or above.
- 4) Select clip from list on next page and add suffix to end of part number.
- 5) Select the appropriate "T" lock option from next page and add suffix to end of part number.

#### Example Ordering Chart

Channel Length	Number Stamped on Balance	Our Part Number	Clip Attached	Tilt Shoe Attached	Complete Part Number
28"	28A	62-716-28A-	60-950	62-50007	62-716-28A-34C

These balances are special order  
Contact Your Account Manager For Delivery Schedules

## 62-716 & 62-766 SERIES BALANCES ACCESSORIES

### CLIPS

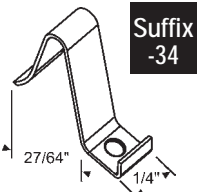

Suffix  
-34

**60-950**

Form Fit Hanger  
Use with Traditional Pulley

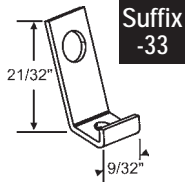

Suffix  
-33

**60-937**

Form Fit Screw-in  
Use with Traditional Pulley



Suffix  
-20

**60-952**

Snap-in

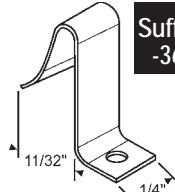

Suffix  
-36

**62-50041**

Hanger  
Use with Reverse Lace

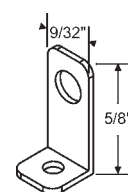

Suffix  
-19

**60-951**

Screw-in  
Use with Reverse Lace



Suffix  
-31

**62-50051**

Hanger  
Use with Reverse Lace

### TILT SHOES

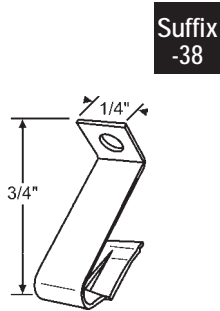

Suffix  
-38

**60-965**

Not Sold Separately  
**REPUBLIC**

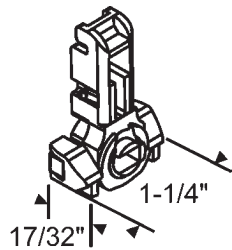

Part #	Puck Color	Cam	Suffix
62-50002	White	Open	H
62-50003	White	Closed	D
62-50004	Black	Closed	I
62-50005	Blue	Closed	B
62-50015	Black	Open	J

T-Lock/Molded Spring  
Stamped Pivot

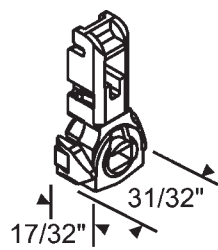

Part #	Puck Color	Cam	Suffix
62-50006	Green	Closed	A
62-50007	Green	Open	C

T-Lock

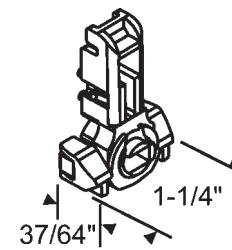

Part #	Puck Color	Cam	Suffix
62-50008	White	Closed	K
62-50010	Blue	Closed	L

T-Lock

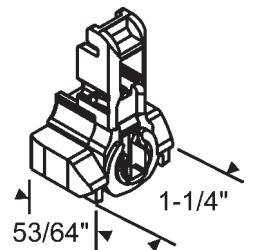

Part #	Puck Color	Cam	Suffix
62-50012	Tan	Open	P

Front-to-Back T-Lock  
Twin Cam

### PIVOT SHOE

### PIVOT BARS

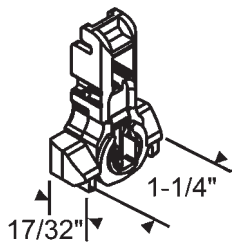

Part #	Puck Color	Cam	Suffix
62-50011	Tan	Open	N

Front-to-Back T-Lock

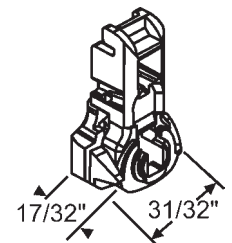

Part #	Puck Color	Cam	Suffix
62-50033	Black	Open	W

Front-to-Back T-Lock



Suffix  
M

**62-50013**

Inverted Link  
Used with 62-50014

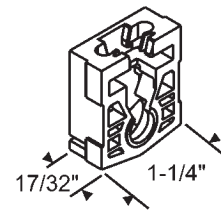

**62-50014**

Sold Separately

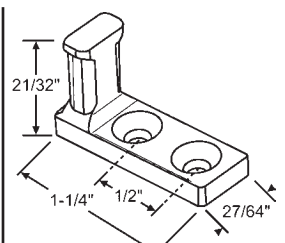

**62-824**

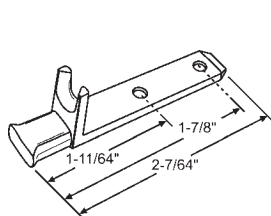

**62-825**

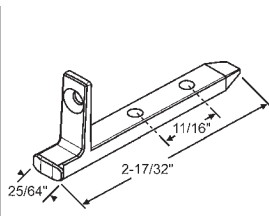

**62-50046**

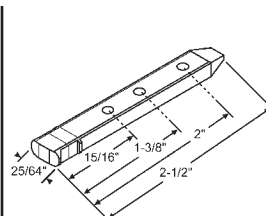

**62-826**

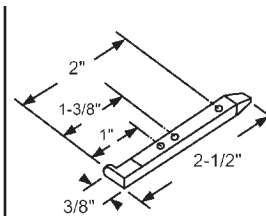

**62-540D**

No Longer Available  
Use 62-540K

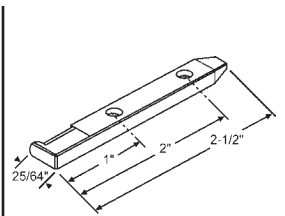

**62-540K**

# SASH SUPPORT SYSTEMS

## 62-716 & 62-766 SERIES BALANCES ACCESSORIES

### PIVOT BARS

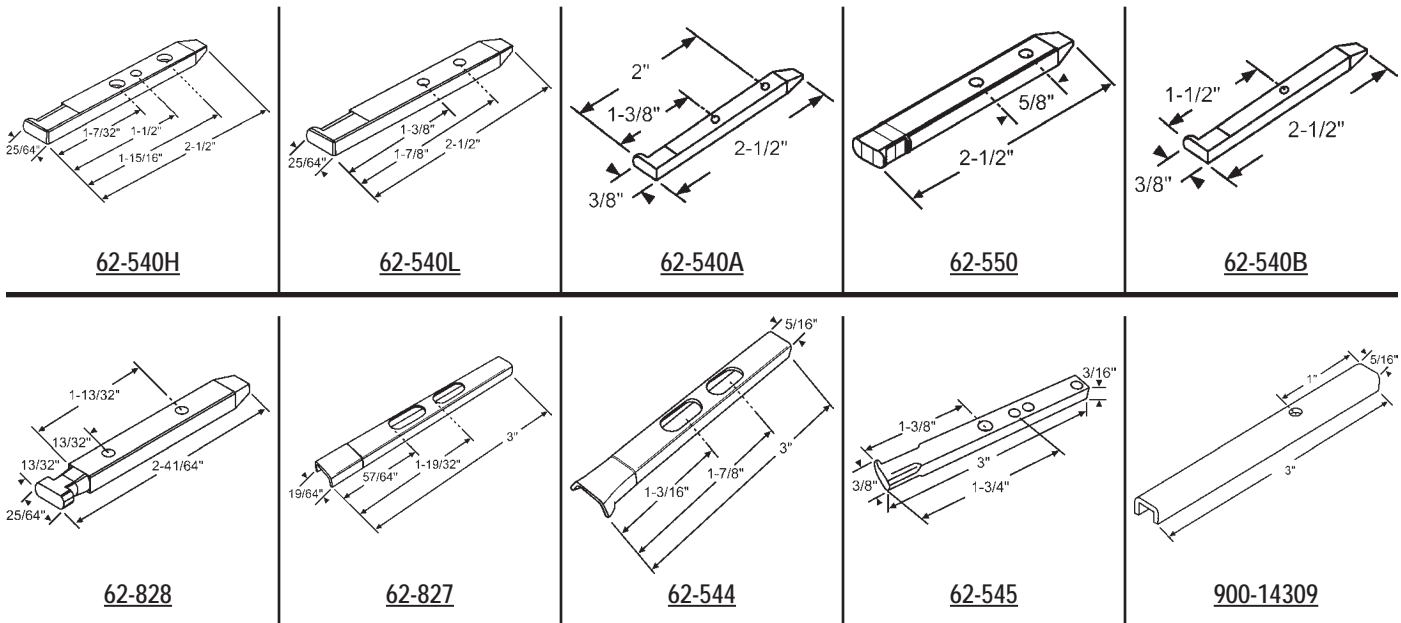

62-540H

62-540L

62-540A

62-550

62-540B

62-828

62-827

62-544

62-545

900-14309

### ADHESIVE SEALANT



Part #	Color
59-100	Clear
59-100W	White



#### Adheres To

- Vinyl • Aluminum • Wood • Steel
- Brick • Concrete • Stone • Ceramics
- Fiberglass • Masonry • Building Paper

#### Product Description

- Waterproof, Premium All-Weather Silicone
- Excellent Tooling Characteristics
- UV and Mildew Resistant
- Permanently Flexible
- Will Not Shrink, Crack, Sag or Slump
- Service Temperature -40°F to +400°F
- Application Temperature +32°F to +120°F

#### Flex Facts

- Permanently flexible
- Will not shrink & crack
- Will not sag or slump
- Weather tight seal
- Excellent adhesion to all building substrates
- Waterproof
- Mold/Mildew resistant
- Easily gunned at all temperatures—Winter and Summer
- VOC compliant in all 50 states
- Excellent tooling
- Low odor
- Solvent free
- Invisible to UV light
- Tack free in 10 minutes
- Completely cured within 2 days
- AAMA verified for all Window installations
- Will not freeze
- Can be used on interior and exterior
- Plastic tubes-will not fall apart
- Removable tips-No wasted sealant left in fixed tips
- Ability to use entire tube-or can save with end cap - No waste
- Available in all major siding and window manufacturer colors

**Other colors available in carton only (12 per carton): Blue White, Antique White, Canvas, Black, Gray, Dark Bronze, Lincoln Bronze, Imperial Brown, Earthtone, Terratone, Dark Sand, Beige, Tan, Almond, Sandstone, Forest Green**



### GLASS CLEANER



**59-101**  
19 oz. can  
12 cans per case

#### Foaming Glass Cleaner

- Industrial Strength
- The most versatile glass cleaner available
- Cleans glass, windows, mirrors, windshields, enamel surfaces, chrome, tile, porcelain and other hard surfaces.
- Sprays in any position
- Dissolves dirt, grease, grit and grime
- Heavy-Duty Foam clings to vertical surfaces
- Non-ammoniated
- Guaranteed to leave no film - "Streak Free"
- Safe on tinted glass, plastic and mirrors
- Contains cosmetic-grade alcohol for best performance
- Superior quality at competitive pricing
- Patent Pending Formulation

Spray X Glass Cleaner contains less water and more cleaning power. Our patent pending formulation allows us to meet the current VOC regulations and deliver maximum cleaning performance for our customers. Compare our alcohol content to other national brands and you'll notice our quality is significantly higher

Spray X Glass Cleaner uses SD-40B cosmetic grade alcohol that is 200 proof and 99.9% pure. This type of alcohol requires a registration with the US Department of Alcohol, Tobacco and Firearms, and each Spray-X Glass Cleaner can is marked with our registration number. Compare our registration to other brands and you'll quickly agree this product has been performance engineered to meet all your glass cleaning needs.

Spray X Glass Cleaner for cleaning and polishing glass, mirrors and other nonporous surfaces. This easy-to-use, fast-acting product uses clinging foam to break up soils and hold them -even on vertical surfaces. There's no dripping, no running and no streaking. With an exclusive industrial strength formulation, this product cleans thoroughly, dries quickly, requires no rinsing and leaves a pleasant, fresh aroma.

Spray-X Glass Cleaner utilizes a 360 degree valve for ease of use. This allows our product to be sprayed right side up or upside down. Other brands cannot spray upside down, but we have this solid valve feature, plus the anti-fatigue finger pad makes this packaging very attractive to all users.

Spray-X Glass Cleaner is alcohol based. It does not contain ammonia. When comparing our performance on tinted glass to ammoniated brands most professional installers praise the difference.

Spray-X Glass Cleaner is packaged in a two-piece steel can. No side seam means we use less energy and material and generate less waste. Our can weighs 10% less than the three-piece equivalent and is 100% recyclable. You will appreciate the new contemporary can design.



## 62DV SERIES DEVAC OVERHEAD CHANNEL BALANCES

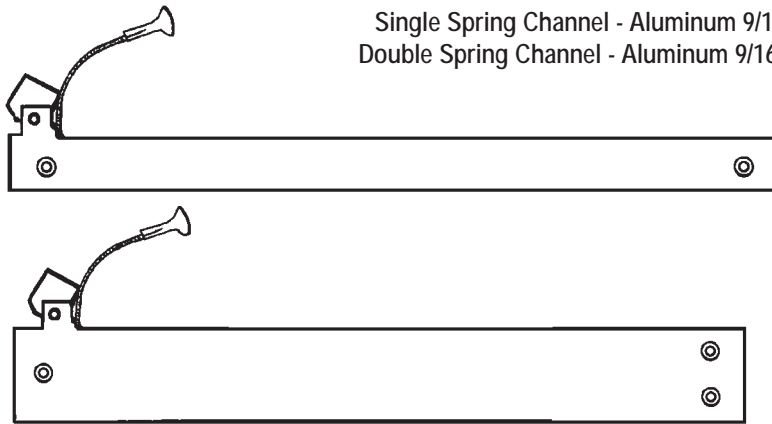

Single Spring Channel - Aluminum 9/16" Wide x 5/8" Deep  
 Double Spring Channel - Aluminum 9/16" Wide x 13/16" Deep

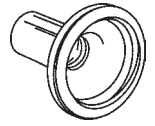
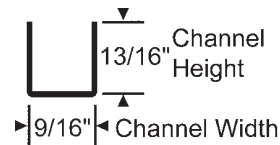
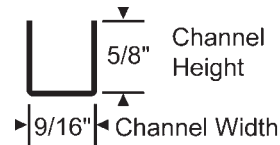

**900-9036**  
 Standard Bell Clip Attached

### Ordering Information

- 1) Measure metal channel length.
- 2) Check number old or new stamped on balance (e.g. 111 or 1210).
- 3) Select our corresponding part number from the chart below and order accordingly.
- 4) All balances come with 900-9036 attached.

### General Information

- 1) All balances now use Dacron cord. Stainless steel cable with copper hook terminal is no longer being produced.
- 2) It is important to note how much cord extends from your balance to the window sill (in inches) in order to ensure the proper amount of cord travel. Our chart will indicate standard lengths but if additional inches of cord are required, add a plus (+) sign after the part number and indicate the number of extra inches of cord required.
- 3) When the letter "D" alone is stamped on your balance, it denotes a double spring. "HD", on the other hand, simply denotes heavy duty.

**Note: Minimum order required for this series.  
 Must order minimum of four (4) of the same size balance.**

Old Balance Number	Old Balance Length	New Balance Number	New Balance Length	Standard Cord Length in Balance	Sash Weight Per Pair	Our Part #
111	12-3/4"	1210 HD	13"	31"	4-7 lbs.	62DV-1210HD
112	12-3/4"	1220 HD	13"	31"	7-11 lbs.	62DV-1220HD
112-D	13-1/4"	112 D	13-1/4"	36"	11-18 lbs.	62DV-112D
121	15-1/4"	1510 HD	16"	37"	5-9 lbs.	62DV-1510HD
122	15-1/4"	1520 HD	16"	37"	9-13 lbs.	62DV-1520HD
122-D	16-1/4"	122-D	16-1/4"	42"	12-22 lbs.	62DV-122D
151	19-1/4"	1910 HD	20"	41"	5-11 lbs.	62DV-1910HD
152	19-1/4"	1920 HD	20"	41"	8-14 lbs.	62DV-1920HD
153	19-1/4"	1930 HD	20"	41"	14-18 lbs.	62DV-1930HD
153-D	19-3/4"	153-D	19-3/4"	47"	16-28 lbs.	62DV-153D
162	23-1/4"	2320 HD	24"	47"	9-14 lbs.	62DV-2320HD
163	23-1/4"	2330 HD	24"	47"	12-20 lbs.	62DV-2330HD
163-D	23-1/4"	163-D	23-3/4"	53"	20-32 lbs.	62DV-163D
183	27-1/4"	2730 HD	28"	50"	16-25 lbs.	62DV-2730HD
183-D	28-1/4"	183-D	28-1/4"	58"	22-34 lbs.	62DV-183D

### DEVAC SASH STOPS

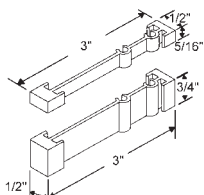

**900-10445B**  
 2 Piece Set - Black,  
 Aluminum

### PIN LOCKING SPRING

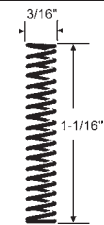

**900-14913**

### LOCKING PINS

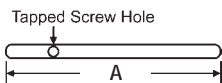

Part #	A
900-9678	2-1/4"
900-9677	2-1/2"

### CUSHION BLOCK SPRING

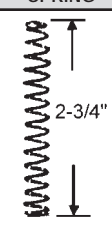

**900-9676**

### NYLON CUSHION SHOE



**900-10443**  
 Red

### NYLON CUSHION BLOCK

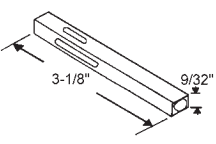

**900-9675**  
 Red

### NYLON BALANCE CUSHION

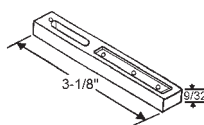

**900-10442**  
 Red

### PIN LOCK SCREW

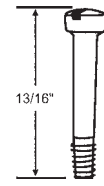

**900-10444**

### LATCH ASSEMBLY HOUSING

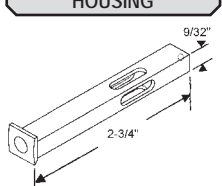

**900-9674**

### PIN LOCKING HANDLE

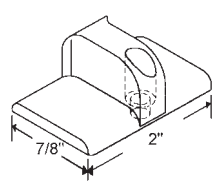

**900-9679**  
 Black

### SASH CLIPS

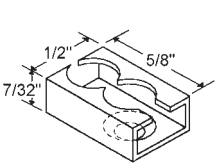

**900-15841**

### SPRING

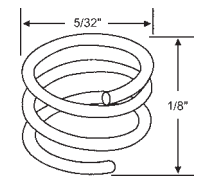

**900-14743**

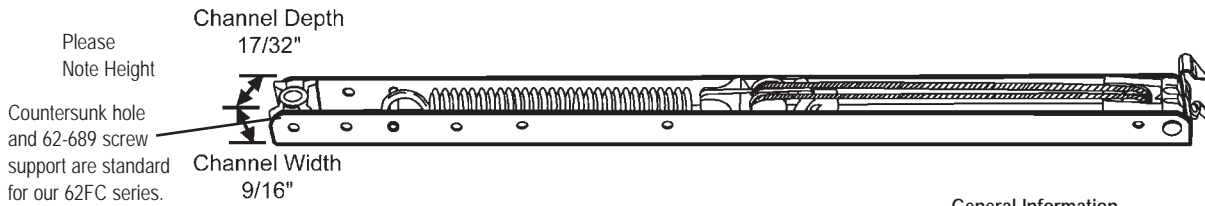

### Ordering Information

- 1) Measure metal channel length (Do not include any attached ends).
- 2) Identify number stamped on channel. (e.g., 21A, 24B, etc.)
- 3) Select our corresponding part number from the chart below.
- 4) Identify the appropriate balance end to be attached; add the appropriate suffix -1 (60-518) or -5 (900-18354) after the part number and order accordingly.
- 5) If the letter "T" appears after the number stamped, it indicates a top sash balance; when ordering, add the letter "T" at the end of our part number.

- ### General Information
- 1) Please note that the 1/2" channel height is smaller than the usual 19/32" height on standard balances.
  - 2) If metal channel length does not correspond with the number stamped on balance, consult your representative since your balance may be a special order.

### Example Ordering Chart

Channel Length	Number Stamped	Part Number	End Attached	Complete Part Number
21"	21A	62FC-21A	-1	62FC-21A-1
24"	24B	62FC-24B	-5	62FC-24B-5

Length of Metal Channel	Number Stamped on Balance	Sash Weight	Our Part Number	Length of Metal Channel	Number Stamped on Balance	Sash Weight	Our Part Number
10"	10A	2-6 lbs.	62FC-10A-	18"	18A	4-9 lbs.	62FC-18A-
10"	10B	6-10 lbs.	62FC-10B-	18"	18B	9-13 lbs.	62FC-18B-
10"	10C	10-13 lbs.	62FC-10C-	18"	18C	13-18 lbs.	62FC-18C-
11"	11A	3-7 lbs.	62FC-11A-	18"	18D	18-21 lbs.	62FC-18D-
11"	11B	7-10 lbs.	62FC-11B-	18"	18E	21-24 lbs.	62FC-18E-
11"	11C	10-16 lbs.	62FC-11C-	18"	18F	24-26 lbs.	62FC-18F-
11"	11D	16-18 lbs.	62FC-11D-	18"	18G	26-29 lbs.	62FC-18G-
12"	12A	3-7 lbs.	62FC-12A-	18"	18H	29-32 lbs.	62FC-18H-
12"	12B	7-10 lbs.	62FC-12B-	18"	18I	32-34 lbs.	62FC-18I-
12"	12C	10-16 lbs.	62FC-12C-	19"	19A	4-9 lbs.	62FC-19A-
12"	12D	16-18 lbs.	62FC-12D-	19"	19B	9-13 lbs.	62FC-19B-
13"	13A	3-7 lbs.	62FC-13A-	19"	19C	13-18 lbs.	62FC-19C-
13"	13B	7-10 lbs.	62FC-13B-	19"	19D	18-21 lbs.	62FC-19D-
13"	13C	10-16 lbs.	62FC-13C-	19"	19E	21-24 lbs.	62FC-19E-
13"	13D	16-18 lbs.	62FC-13D-	19"	19F	24-26 lbs.	62FC-19F-
14"	14A	3-7 lbs.	62FC-14A-	19"	19G	26-29 lbs.	62FC-19G-
14"	14B	7-10 lbs.	62FC-14B-	19"	19H	29-32 lbs.	62FC-19H-
14"	14C	10-16 lbs.	62FC-14C-	19"	19I	32-34 lbs.	62FC-19I-
14"	14D	16-19 lbs.	62FC-14D-	20"	20A	5-10 lbs.	62FC-20A-
14"	14E	19-22 lbs.	62FC-14E-	20"	20B	10-14 lbs.	62FC-20B-
14"	14F	22-25 lbs.	62FC-14F-	20"	20C	14-18 lbs.	62FC-20C-
14"	14G	25-28 lbs.	62FC-14G-	20"	20D	18-22 lbs.	62FC-20D-
14"	14H	28-31 lbs.	62FC-14H-	20"	20E	22-26 lbs.	62FC-20E-
14"	14I	31-34 lbs.	62FC-14I-	20"	20F	26-30 lbs.	62FC-20F-
15"	15A	3-7 lbs.	62FC-15A-	20"	20G	30-34 lbs.	62FC-20G-
15"	15B	7-10 lbs.	62FC-15B-	20"	20H	34-37 lbs.	62FC-20H-
15"	15C	10-16 lbs.	62FC-15C-	20"	20I	37-40 lbs.	62FC-20I-
15"	15D	16-19 lbs.	62FC-15D-	21"	21A	5-10 lbs.	62FC-21A-
15"	15E	19-22 lbs.	62FC-15E-	21"	21B	10-14 lbs.	62FC-21B-
15"	15F	22-25 lbs.	62FC-15F-	21"	21C	14-18 lbs.	62FC-21C-
15"	15G	25-28 lbs.	62FC-15G-	21"	21D	18-22 lbs.	62FC-21D-
15"	15H	28-31 lbs.	62FC-15H-	21"	21E	22-26 lbs.	62FC-21E-
15"	15I	31-34 lbs.	62FC-15I-	21"	21F	26-30 lbs.	62FC-21F-
16"	16A	3-7 lbs.	62FC-16A-	21"	21G	30-34 lbs.	62FC-21G-
16"	16B	7-10 lbs.	62FC-16B-	21"	21H	34-37 lbs.	62FC-21H-
16"	16C	10-16 lbs.	62FC-16C-	21"	21I	37-40 lbs.	62FC-21I-
16"	16D	16-19 lbs.	62FC-16D-	22"	22A	5-10 lbs.	62FC-22A-
16"	16E	19-22 lbs.	62FC-16E-	22"	22B	10-14 lbs.	62FC-22B-
16"	16F	22-24 lbs.	62FC-16F-	22"	22C	14-18 lbs.	62FC-22C-
16"	16G	24-28 lbs.	62FC-16G-	22"	22D	18-22 lbs.	62FC-22D-
16"	16H	28-31 lbs.	62FC-16H-	22"	22E	22-26 lbs.	62FC-22E-
16"	16I	31-34 lbs.	62FC-16I-	22"	22F	26-30 lbs.	62FC-22F-
17"	17A	3-7 lbs.	62FC-17A-	22"	22G	30-34 lbs.	62FC-22G-
17"	17B	7-10 lbs.	62FC-17B-	22"	22H	34-37 lbs.	62FC-22H-
17"	17C	10-16 lbs.	62FC-17C-	22"	22I	37-40 lbs.	62FC-22I-
17"	17D	16-19 lbs.	62FC-17D-	23"	23A	5-10 lbs.	62FC-23A-
17"	17E	19-22 lbs.	62FC-17E-	23"	23B	10-14 lbs.	62FC-23B-
17"	17F	22-24 lbs.	62FC-17F-	23"	23C	14-18 lbs.	62FC-23C-
17"	17G	24-28 lbs.	62FC-17G-	23"	23D	18-22 lbs.	62FC-23D-
17"	17H	28-31 lbs.	62FC-17H-	23"	23E	22-26 lbs.	62FC-23E-
17"	17I	31-34 lbs.	62FC-17I-	23"	23F	26-30 lbs.	62FC-23F-

### END BRACKETS

Add suffix to complete part number.

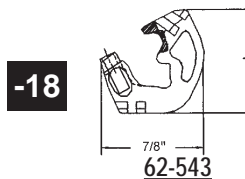
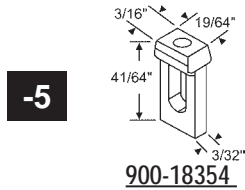
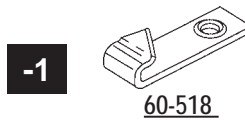

Note: Old manufacturer (Jim Walters) of this series balance stamped it with a four digit number (e.g. 2130). These balances are no longer manufactured with that stamping. To identify your balance and match up properly with the new manufacturer's balances, you must take the following steps:

1. Measure exact length of channel.
2. Identify the weight range you require.
  - Weighing your sash is the only way to get the exact weight range required.
  - The old balance with the 4 digit number has a different weight range than the new balances.
  - Consult your account manager if you have any questions.
3. Select our corresponding part number from the chart.
4. Identify the appropriate balance end that needs to be attached.

Chart continued on next page.

## 62FC SERIES 1/2" X 1/2" TILT CHANNEL BALANCE

Chart continued from previous page.

Length of Metal Channel	Number Stamped on Balance	Sash Weight	Our Part Number	Length of Metal Channel	Number Stamped on Balance	Sash Weight	Our Part Number	Length of Metal Channel	Number Stamped on Balance	Sash Weight	Our Part Number
23"	23G	30-34 lbs.	62FC-23G-	31"	31C	19-24 lbs.	62FC-31C-	38"	38H	40-43 lbs.	62FC-38H-
23"	23H	34-37 lbs.	62FC-23H-	31"	31D	24-29 lbs.	62FC-31D-	38"	38I	43-45 lbs.	62FC-38I-
23"	23I	37-40 lbs.	62FC-23I-	31"	31E	29-33 lbs.	62FC-31E-	39"	39A	11-16 lbs.	62FC-39A-
24"	24A	6-11 lbs.	62FC-24A-	31"	31F	33-37 lbs.	62FC-31F-	39"	39B	16-22 lbs.	62FC-39B-
24"	24B	11-17 lbs.	62FC-24B-	31"	31G	37-40 lbs.	62FC-31G-	39"	39C	22-27 lbs.	62FC-39C-
24"	24C	17-22 lbs.	62FC-24C-	31"	31H	40-43 lbs.	62FC-31H-	39"	39D	27-32 lbs.	62FC-39D-
24"	24D	22-25 lbs.	62FC-24D-	31"	31I	43-45 lbs.	62FC-31I-	39"	39E	32-34 lbs.	62FC-39E-
24"	24E	25-28 lbs.	62FC-24E-	32"	32A	8-14 lbs.	62FC-32A-	39"	39F	34-37 lbs.	62FC-39F-
24"	24F	28-30 lbs.	62FC-24F-	32"	32B	14-20 lbs.	62FC-32B-	39"	39G	37-40 lbs.	62FC-39G-
24"	24G	30-34 lbs.	62FC-24G-	32"	32C	20-25 lbs.	62FC-32C-	39"	39H	40-43 lbs.	62FC-39H-
24"	24H	34-37 lbs.	62FC-24H-	32"	32D	25-30 lbs.	62FC-32D-	39"	39I	43-45 lbs.	62FC-39I-
24"	24I	37-40 lbs.	62FC-24I-	32"	32E	30-34 lbs.	62FC-32E-	40"	40A	11-16 lbs.	62FC-40A-
25"	25A	6-11 lbs.	62FC-25A-	32"	32F	34-37 lbs.	62FC-32F-	40"	40B	16-22 lbs.	62FC-40B-
25"	25B	11-17 lbs.	62FC-25B-	32"	32G	37-40 lbs.	62FC-32G-	40"	40C	22-27 lbs.	62FC-40C-
25"	25C	17-22 lbs.	62FC-25C-	32"	32H	40-43 lbs.	62FC-32H-	40"	40D	27-32 lbs.	62FC-40D-
25"	25D	22-25 lbs.	62FC-25D-	32"	32I	43-45 lbs.	62FC-32I-	40"	40E	32-34 lbs.	62FC-40E-
25"	25E	25-28 lbs.	62FC-25E-	33"	33A	8-14 lbs.	62FC-33A-	40"	40F	34-37 lbs.	62FC-40F-
25"	25F	28-30 lbs.	62FC-25F-	33"	33B	14-20 lbs.	62FC-33B-	40"	40G	37-40 lbs.	62FC-40G-
25"	25G	30-34 lbs.	62FC-25G-	33"	33C	20-25 lbs.	62FC-33C-	40"	40H	40-43 lbs.	62FC-40H-
25"	25H	34-37 lbs.	62FC-25H-	33"	33D	25-30 lbs.	62FC-33D-	40"	40I	43-45 lbs.	62FC-40I-
25"	25I	37-40 lbs.	62FC-25I-	33"	33E	30-34 lbs.	62FC-33E-	41"	41A	11-16 lbs.	62FC-41A-
26"	26A	6-11 lbs.	62FC-26A-	33"	33F	34-37 lbs.	62FC-33F-	41"	41B	16-22 lbs.	62FC-41B-
26"	26B	11-17 lbs.	62FC-26B-	33"	33G	37-40 lbs.	62FC-33G-	41"	41C	22-27 lbs.	62FC-41C-
26"	26C	17-22 lbs.	62FC-26C-	33"	33H	40-43 lbs.	62FC-33H-	41"	41D	27-32 lbs.	62FC-41D-
26"	26D	22-26 lbs.	62FC-26D-	33"	33I	43-45 lbs.	62FC-33I-	41"	41E	32-34 lbs.	62FC-41E-
26"	26E	26-30 lbs.	62FC-26E-	34"	34A	11-16 lbs.	62FC-34A-	41"	41F	34-37 lbs.	62FC-41F-
26"	26F	30-34 lbs.	62FC-26F-	34"	34B	16-22 lbs.	62FC-34B-	41"	41G	37-40 lbs.	62FC-41G-
26"	26G	34-38 lbs.	62FC-26G-	34"	34C	22-27 lbs.	62FC-34C-	41"	41H	40-43 lbs.	62FC-41H-
26"	26H	38-42 lbs.	62FC-26H-	34"	34D	27-32 lbs.	62FC-34D-	41"	41I	43-45 lbs.	62FC-41I-
26"	26I	42-45 lbs.	62FC-26I-	34"	34E	32-34 lbs.	62FC-34E-	42"	42A	11-16 lbs.	62FC-42A-
27"	27A	6-11 lbs.	62FC-27A-	34"	34F	34-37 lbs.	62FC-34F-	42"	42B	16-22 lbs.	62FC-42B-
27"	27B	11-17 lbs.	62FC-27B-	34"	34G	37-40 lbs.	62FC-34G-	42"	42C	22-27 lbs.	62FC-42C-
27"	27C	17-22 lbs.	62FC-27C-	34"	34H	40-43 lbs.	62FC-34H-	42"	42D	27-32 lbs.	62FC-42D-
27"	27D	22-26 lbs.	62FC-27D-	34"	34I	43-45 lbs.	62FC-34I-	42"	42E	32-34 lbs.	62FC-42E-
27"	27E	26-30 lbs.	62FC-27E-	35"	35A	11-16 lbs.	62FC-35A-	42"	42F	34-37 lbs.	62FC-42F-
27"	27F	30-34 lbs.	62FC-27F-	35"	35B	16-22 lbs.	62FC-35B-	42"	42G	37-40 lbs.	62FC-42G-
27"	27G	34-38 lbs.	62FC-27G-	35"	35C	22-27 lbs.	62FC-35C-	42"	42H	40-43 lbs.	62FC-42H-
27"	27H	38-42 lbs.	62FC-27H-	35"	35D	27-32 lbs.	62FC-35D-	42"	42I	43-45 lbs.	62FC-42I-
27"	27I	42-45 lbs.	62FC-27I-	35"	35E	32-34 lbs.	62FC-35E-	43"	43A	11-16 lbs.	62FC-43A-
28"	28A	7-12 lbs.	62FC-28A-	35"	35F	34-37 lbs.	62FC-35F-	43"	43B	16-22 lbs.	62FC-43B-
28"	28B	12-18 lbs.	62FC-28B-	35"	35G	37-40 lbs.	62FC-35G-	43"	43C	22-27 lbs.	62FC-43C-
28"	28C	18-23 lbs.	62FC-28C-	35"	35H	40-43 lbs.	62FC-35H-	43"	43D	27-32 lbs.	62FC-43D-
28"	28D	23-28 lbs.	62FC-28D-	35"	35I	43-45 lbs.	62FC-35I-	43"	43E	32-34 lbs.	62FC-43E-
28"	28E	28-32 lbs.	62FC-28E-	36"	36A	11-16 lbs.	62FC-36A-	43"	43F	34-37 lbs.	62FC-43F-
28"	28F	32-36 lbs.	62FC-28F-	36"	36B	16-22 lbs.	62FC-36B-	43"	43G	37-40 lbs.	62FC-43G-
28"	28G	36-40 lbs.	62FC-28G-	36"	36C	22-27 lbs.	62FC-36C-	43"	43H	40-43 lbs.	62FC-43H-
28"	28H	40-43 lbs.	62FC-28H-	36"	36D	27-32 lbs.	62FC-36D-	43"	43I	43-45 lbs.	62FC-43I-
28"	28I	43-45 lbs.	62FC-28I-	36"	36E	32-34 lbs.	62FC-36E-	44"	44A	11-16 lbs.	62FC-44A-
29"	29A	7-12 lbs.	62FC-29A-	36"	36F	34-37 lbs.	62FC-36F-	44"	44B	16-22 lbs.	62FC-44B-
29"	29B	12-18 lbs.	62FC-29B-	36"	36G	37-40 lbs.	62FC-36G-	44"	44C	22-27 lbs.	62FC-44C-
29"	29C	18-23 lbs.	62FC-29C-	36"	36H	40-43 lbs.	62FC-36H-	44"	44D	27-32 lbs.	62FC-44D-
29"	29D	23-28 lbs.	62FC-29D-	36"	36I	43-45 lbs.	62FC-36I-	44"	44E	32-34 lbs.	62FC-44E-
29"	29E	28-32 lbs.	62FC-29E-	37"	37A	11-16 lbs.	62FC-37A-	44"	44F	34-37 lbs.	62FC-44F-
29"	29F	32-36 lbs.	62FC-29F-	37"	37B	16-22 lbs.	62FC-37B-	44"	44G	37-40 lbs.	62FC-44G-
29"	29G	36-40 lbs.	62FC-29G-	37"	37C	22-27 lbs.	62FC-37C-	44"	44H	40-43 lbs.	62FC-44H-
29"	29H	40-43 lbs.	62FC-29H-	37"	37D	27-32 lbs.	62FC-37D-	44"	44I	43-45 lbs.	62FC-44I-
29"	29I	43-45 lbs.	62FC-29I-	37"	37E	32-34 lbs.	62FC-37E-				
30"	30A	8-13 lbs.	62FC-30A-	37"	37F	34-37 lbs.	62FC-37F-				
30"	30B	13-19 lbs.	62FC-30B-	37"	37G	37-40 lbs.	62FC-37G-				
30"	30C	19-24 lbs.	62FC-30C-	37"	37H	40-43 lbs.	62FC-37H-				
30"	30D	24-29 lbs.	62FC-30D-	37"	37I	43-45 lbs.	62FC-37I-				
30"	30E	29-33 lbs.	62FC-30E-	38"	38A	11-16 lbs.	62FC-38A-				
30"	30F	33-37 lbs.	62FC-30F-	38"	38B	16-22 lbs.	62FC-38B-				
30"	30G	37-40 lbs.	62FC-30G-	38"	38C	22-27 lbs.	62FC-38C-				
30"	30H	40-43 lbs.	62FC-30H-	38"	38D	27-32 lbs.	62FC-38D-				
30"	30I	43-45 lbs.	62FC-30I-	38"	38E	32-34 lbs.	62FC-38E-				
31"	31A	8-13 lbs.	62FC-31A-	38"	38F	34-37 lbs.	62FC-38F-				
31"	31B	13-19 lbs.	62FC-31B-	38"	38G	37-40 lbs.	62FC-38G-				

For balances larger than sizes shown and balances stamped with additional numbers that indicate special sash weights, please consult your account manager. Please contact account manager for pricing.

# SASH SUPPORT SYSTEMS

## 62R SERIES CHANNEL BALANCE (RUSCO)



62-538

Balance Foot

Included with balance purchase.

### Ordering Information

- 1) Measure metal channel length.
- 2) Identify number stamped on channel.
- 3) Select our corresponding part number from the chart below.

Note: Minimum order required for this series.

Must order minimum of four (4) of the same size balance.

### 62R SERIES BALANCE ACCESSORIES

Length of Metal Channel	Number Stamped on Balance	Weight Range	Our Part Number	Length of Metal Channel	Number Stamped on Balance	Weight Range	Our Part Number
10-1/2"	10A-C	3-6 lbs.	62R-10A	24"	23E	10-15 lbs.	62R-23E
10-1/2"	10B-C	7-9 lbs.	62R-10B	24"	23F	16-18 lbs.	62R-23F
10-1/2"	10D-C	10-12 lbs.	62R-10D	23-1/16"	23S		62R-23S
10-3/16"	10-S		62R-10S				
11-7/8"	11A	3-6 lbs.	62R-11A	24-3/8"	24F		62R-24F
11-7/8"	11B	7-9 lbs.	62R-11B	24-11/32"	24S		62R-24S
11-7/8"	11D	10-12 lbs.	62R-11D	26"	25B	10-15 lbs.	62R-25B
				26"	25C	16-19 lbs.	62R-25C
14-3/8"	14A		62R-14A	26"	25D	20-25 lbs.	62R-25D
15-7/8"	15A	4-6 lbs.	62R-15A	25-5/8"	25S		62R-25S
15-7/8"	15B	7-10 lbs.	62R-15B	26-1/2"	26C		62R-26C
				26-25/32"	26S		62R-26S
15-7/8"	15D	11-13 lbs.	62R-15D	27-7/8"	27A	5-9 lbs.	62R-27A
				27-7/8"	27B	10-13 lbs.	62R-27B
16-11/16"	16A-C	5-8 lbs.	62R-16A	27-7/8"	27C	14-19 lbs.	62R-27C
16-11/16"	16B-C	9-12 lbs.	62R-16B	27-7/8"	27D	20-26 lbs.	62R-27D
16-11/16"	16D-C	13-19 lbs.	62R-16D	27-15/16"	27S		62R-27S
16-11/16"	16E-C	20-22 lbs.	62R-16E	27-7/8"	27E	27-30 lbs.	62R-27E
16-1/8"	16F		62R-16F	29"	28A-C	7-12 lbs.	62R-28A
16-13/32"	16S		62R-16S	29"	28B-C	13-16 lbs.	62R-28B
16-11/16"	16S-11		62R-16S-11	29"	28C-C	17-23 lbs.	62R-28C
16-11/16"	16S-18		62R-16S-18	29"	28D-C	24-28 lbs.	62R-28D
18"	17A	9-12 lbs.	62R-17A	29"	28E-C	29-32 lbs.	62R-28E
18"	17B	13-17 lbs.	62R-17B	28-9/16"	28S-28		62R-28S
18"	17D		62R-17D	29"	28F-C	32-35 lbs.	62R-28F
18"	17C		62R-17C	32"	31B	13-16 lbs.	62R-31B
18-1/4"	18B		62R-18B	32"	31C	17-23 lbs.	62R-31C
18-21/32"	18S		62R-18S	32"	31D	24-28 lbs.	62R-31D
19-7/8"	19A	5-8 lbs.	62R-19A	32"	31E	29-32 lbs.	62R-31E
19-7/8"	19B	9-12 lbs.	62R-19B				
19-7/8"	19D	13-17 lbs.	62R-19D	33-7/8"	33A	8-13 lbs.	62R-33A
19-7/8"	19S		62R-19S	33-7/8"	33B	14-18 lbs.	62R-33B
20-5/8"	20C		62R-20C	33-7/8"	33C	19-23 lbs.	62R-33C
20-5/8"	20D		62R-20D	33-7/8"	33D	24-28 lbs.	62R-33D
20-3/4"	20E		62R-20E	33-7/8"	33E	29-32 lbs.	62R-33E
20-3/8"	20S		62R-20S				
21-7/8"	21A	5-8 lbs.	62R-21A	35-7/8"	35A-C	8-13 lbs.	62R-35A
21-7/8"	21B	9-12 lbs.	62R-21B	35-7/8"	35B-C	14-18 lbs.	62R-35B
21-7/8"	21C	13-15 lbs.	62R-21C	35-7/8"	35C-C	19-23 lbs.	62R-35C
21-7/8"	21D	16-23 lbs.	62R-21D	35-7/8"	35D-C	24-30 lbs.	62R-35D
21-15/16"	21S		62R-21S	35-7/8"	35E-C	31-35 lbs.	62R-35E
22-13/16"	22A-C	5-8 lbs.	62R-22A	39-7/8"	39A	9-14 lbs.	62R-39A
22-13/16"	22B-C	9-12 lbs.	62R-22B	39-7/8"	39B	15-19 lbs.	62R-39B
22-13/16"	22C-C	13-19 lbs.	62R-22C	39-7/8"	39C	20-24 lbs.	62R-39C
22-13/16"	22D-C	20-23 lbs.	62R-22D	39-7/8"	39D	25-30 lbs.	62R-39D
22-13/16"	22F		62R-22F	39-7/8"	39E	31-35 lbs.	62R-39E
22-9/16"	22S-23		62R-22S	42-7/8"	42A	9-14 lbs.	62R-42A
22-13/16"	22E-C	24-28 lbs.	62R-22E	42-7/8"	42B	15-19 lbs.	62R-42B
23-7/8"	23A	5-9 lbs.	62R-23A	42-7/8"	42C	20-24 lbs.	62R-42C
23-7/8"	23B	10-15 lbs.	62R-23B	42-7/8"	42D	25-30 lbs.	62R-42D
23-7/8"	23C	16-18 lbs.	62R-23C	42-7/8"	42E	31-36 lbs.	62R-42E
23-7/8"	23D	19-22 lbs.	62R-23D				

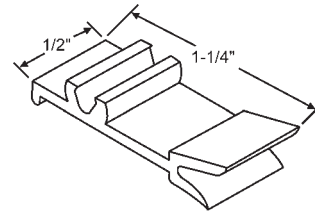

900-19165

Balance Frame Retainer

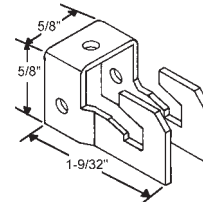

900-19163

Balance Mounting Hook

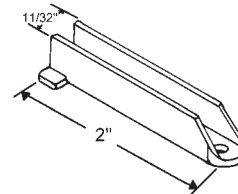

900-19107

Sash Stop  
Black

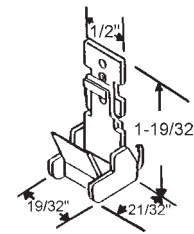

62-538

Balance Foot

Please contact account manager for pricing

## 62V SERIES CHANNEL BALANCE (RUSCO)

OBSOLETE BALANCE AND RELATED COMPONENTS ARE SHOWN FOR REFERENCE ONLY

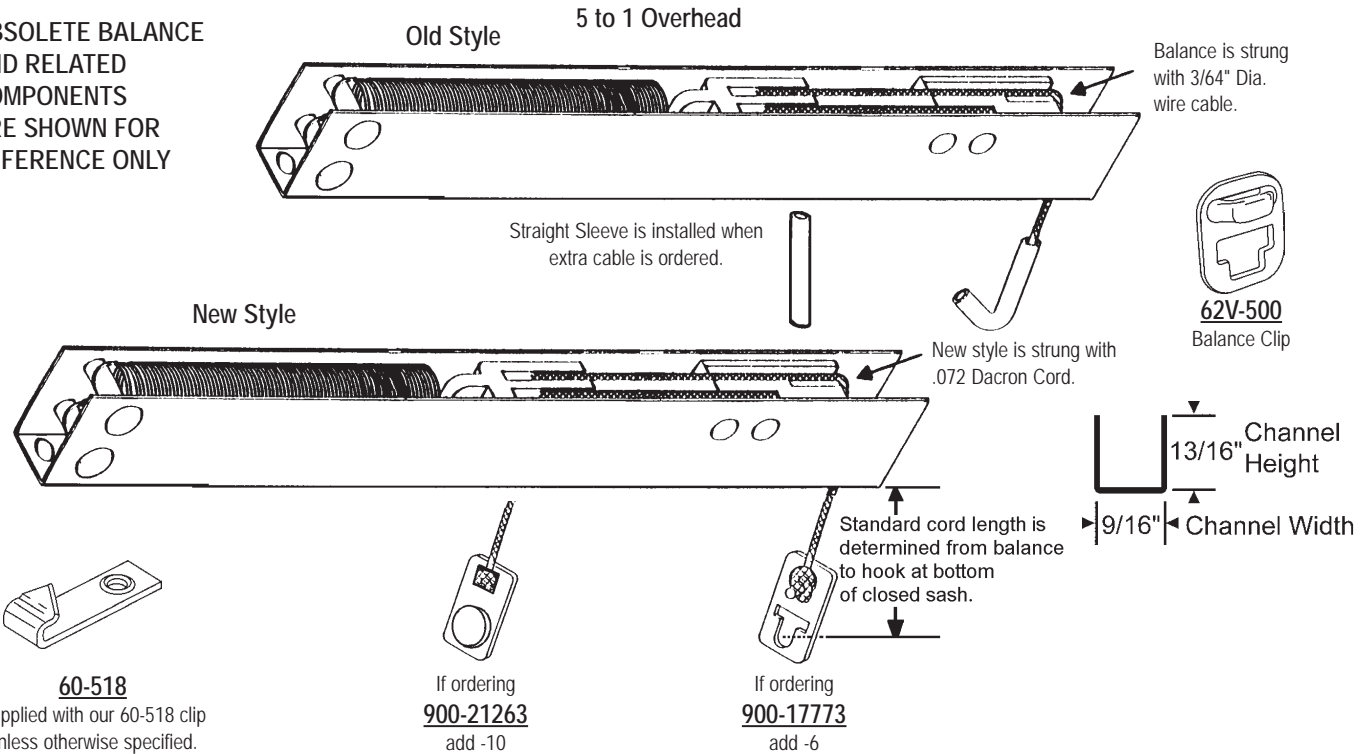

### Ordering Information

- 1) Measure channel length.
- 2) Identify number stamped on balance.
- 3) Customer must determine how much cord hangs down from the balance when the window is closed. If more cord than the standard lengths shown is required, specify number of extra inches required when ordering by adding a plus sign (+) followed by number of extra inches needed.
- 4) Determine the clip to be attached to balance. If ordering with our 900-17773 attached, add -6 after our part number.  
(e.g. If ordering a 153-D balance with our 900-17773 clip attached and 40" of cord is required, the part number would be 62-153D+10-6.)

### General Information

- 1) Balances are supplied with either one or two springs. If the number stamped on your balance is followed by the letter "D" it denotes a double spring.

**Note: Minimum order required for this series.  
Must order minimum of four (4) of the same size balance.**

Length of Metal Channel	Number Stamped on Balance	Our Part Number		Weight Range (2 Balances)
13-1/4"	112	62V-112	Standard extended cord length from balance 20"	4 to 10 lbs.
13-1/4"	112	62V-112+	(Specify extra inches of cord required)	
13-1/4"	112-D	62V-112D	Standard extended cord length from balance 20"	10 to 18 lbs.
13-1/4"	112-D	62V-112D+	(Specify extra inches of cord required)	
16-1/4"	122	62V-122	Standard extended cord length from balance 25"	6 to 12 lbs.
16-1/4"	122	62V-122+	(Specify extra inches of cord required)	
16-1/4"	122-D	62V-122D	Standard extended cord length from balance 25"	12 to 22 lbs.
16-1/4"	122-D	62V-122D+	(Specify extra inches of cord required)	
19-3/4"	153	62V-153	Standard extended cord length from balance 30"	8 to 16 lbs.
19-3/4"	153	62V-153+	(Specify extra inches of cord required)	
19-3/4"	153-D	62V-153D	Standard extended cord length from balance 30"	16 to 28 lbs.
19-3/4"	153-D	62V-153D+	(Specify extra inches of cord required)	
23-3/4"	163	62V-163	Standard extended cord length from balance 36"	10 to 18 lbs.
23-3/4"	163	62V-163+	(Specify extra inches of cord required)	
23-3/4"	163-D	62V-163D	Standard extended cord length from balance 36"	18 to 32 lbs.
23-3/4"	163-D	62V-163D+	(Specify extra inches of cord required)	
28-1/4"	183	62V-183	Standard extended cord length from balance 40"	10 to 16 lbs.
28-1/4"	183	62V-183+	(Specify extra inches of cord required)	
28-1/4"	183-D	62V-183D	Standard extended cord length from balance 40"	16 to 34 lbs.
28-1/4"	183-D	62V-183D+	(Specify extra inches of cord required)	

Please contact account manager for pricing.

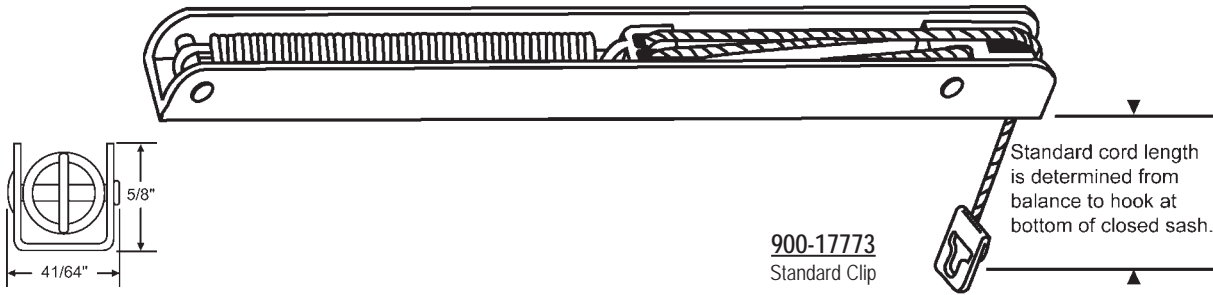

**900-17773**  
Standard Clip

### Ordering Information

- 1) Measure metal channel length.
- 2) Identify number stamped on balance.
- 3) Select our corresponding part number from the chart below and order accordingly.
- 4) Standard clip shown will be attached unless otherwise specified.

### General Information

- 1) If cord lengths are different from the standard lengths shown, a plus sign (+) and the extra number of inches should be added after the part number.
- 2) Determine the balance clip to be attached and order accordingly: standard, 60-518 or 900-18354.

Note: If your balance is stamped with the letters "DBS", refer to our DS balances, since their manufacturing specifications are the same.

### Example Ordering Chart

Channel Length	Number Stamped	Part Number	Extra Cord (In Inches)	End Attached	Complete Part Number
15-1/4"	122	62W-122	10"	-5	62W-122+10-5
19-1/4"	152	62W-152	--	-1	62W-152-1

Length of Metal Channel	Number Stamped on Balance	Our Part Number		Sash Weight Per Pair
12-3/4"	111	62W-111	Standard Cord 20" with standard clip attached	4- 7 lbs.
12-3/4"	111	62W-111+	(Specify extra inches of cord length)	4- 7 lbs.
12-3/4"	112	62W-112	Standard Cord 20" with standard clip attached	7-11 lbs.
12-3/4"	112	62W-112+	(Specify extra inches of cord length)	7-11 lbs.
15-1/4"	121	62W-121	Standard Cord 25" with standard clip attached	4-8 lbs.
15-1/4"	121	62W-121+	(Specify extra inches of cord length)	4-8 lbs.
15-1/4"	122	62W-122	Standard Cord 25" with standard clip attached	8-12 lbs.
15-1/4"	122	62W-122+	(Specify extra inches of cord length)	8-12 lbs.
15-1/4"	122DS	62W-122DS*	Standard Cord 32" with standard clip attached	-
15-1/4"	122DS	62W-122DS+ *	(Specify extra inches of cord length)	-
19-1/4"	151	62W-151	Standard Cord 33" with standard clip attached	5-9 lbs.
19-1/4"	151	62W-151+	(Specify extra inches of cord length)	5-9 lbs.
19-1/4"	152	62W-152	Standard Cord 33" with standard clip attached	9-13 lbs.
19-1/4"	152	62W-152+	(Specify extra inches of cord length)	9-13 lbs.
19-1/4"	153	62W-153	Standard Cord 33" with standard clip attached	13-16 lbs.
19-1/4"	153	62W-153+	(Specify extra inches of cord length)	13-16 lbs.
19-1/4"	153HD	62W-153HD	Standard Cord 30" with standard clip attached	16-18 lbs.
19-1/4"	153HD	62W-153HD+	(Specify extra inches of cord length)	16-18 lbs.
23-1/4"	162	62W-162	Standard Cord 36" with standard clip attached	9-14 lbs.
23-1/4"	162	62W-162+	(Specify extra inches of cord length)	9-14 lbs.
23-1/4"	163	62W-163	Standard Cord 36" with standard clip attached	13-16 lbs.
23-1/4"	163	62W-163+	(Specify extra inches of cord length)	13-16 lbs.
23-1/4"	163HD	62W-163HD	Standard Cord 36" with standard clip attached	15-17 lbs.
23-1/4"	163HD	62W-163HD+	(Specify extra inches of cord length)	15-17 lbs.
25"	24DS	62W-24DS	Standard Cord 36" with standard clip attached	-
25"	24DS	62W-24DS+*	(Specify extra inches of cord length)	-
27-1/4"	183	62W-183	Standard Cord 40" with standard clip attached	17-20 lbs.
27-1/4"	183	62W-183+	(Specify extra inches of cord length)	17-20 lbs.
27-1/4"	183HD	62W-183HD	Standard Cord 36" with standard clip attached	24-27 lbs.
27-1/4"	183HD	62W-183HD+	(Specify extra inches of cord length)	24-27 lbs.
29"	28DS	62W-28DS*	Standard Cord 36" with standard clip attached	-
29"	28DS	62W-28DS+*	(Specify extra inches of cord length)	-
31"	30DS	62W-30DS*	Standard Cord 36" with standard clip attached	-
31"	30DS	62W-30DS+*	(Specify extra inches of cord length)	-
34"	33DS	62W-33DS*	Standard Cord 38" with standard clip attached	-
34"	33DS	62W-33DS+*	(Specify extra inches of cord length)	-
36"	35DS	62W-35DS*	Standard Cord 36" with standard clip attached	-
36"	35DS	62W-35DS+*	(Specify extra inches of cord length)	-

\*Note: When ordering balances where the number stamped on balance ends with DS (example 24DS) you need to specify the exact sash weight within the range listed on the chart.

### END BRACKETS

Add suffix to complete part number.

**-1**

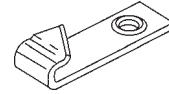

**60-518**

If ordering with our optional 60-518 clip attached, please add "-1" after the part number.

**-5**

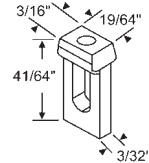

**900-18354**

If ordering with our optional 900-18354 clip attached, please add "-5" after the part number.

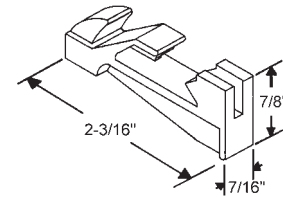

**62W-500**

Black

Primarily used on West Coast by International and other manufacturers.  
Must be ordered separately.

## 64 SERIES CHANNEL BALANCES

### 3/8" CHANNEL BALANCE NON-TILT

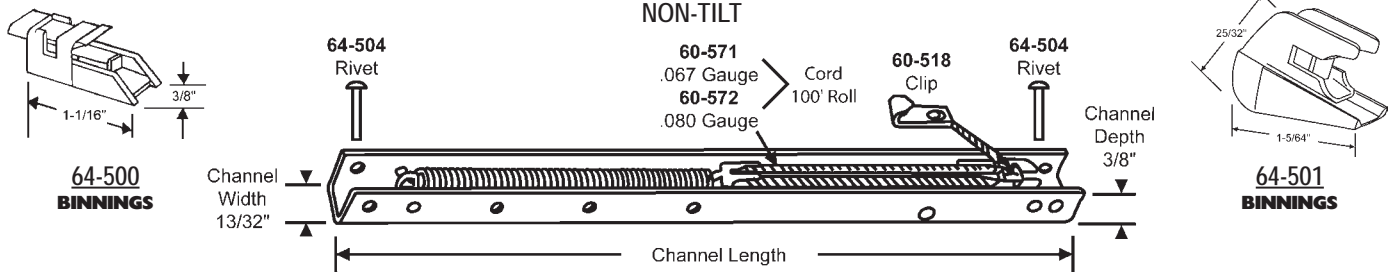

Length of Metal Channel	Number Stamped on Balance	Sash Weight	Our Part Number	Number Stamped on Balance	Sash Weight	Our Part Number	Number Stamped on Balance	Sash Weight	Our Part Number
10"	9A		64-091				9C		64-093
11"	10A	2 through 5	64-101	10B	4 through 7	64-102	10C	8 through 12	64-103
12"	11A	3 through 6	64-111	11B	7 through 9	64-112	11C	10 through 12	64-113
13"	12A	3 through 7	64-121	12B	8 through 12	64-122	12C	13 through 15	64-123
14"	13A	3 through 7	64-131	13B	8 through 12	64-132	13C	13 through 15	64-133
15"	14A	3 through 7	64-141	14B	8 through 12	64-142	14C	13 through 16	64-143
16"	15A	3 through 7	64-151	15B	8 through 12	64-152	15C	13 through 16	64-153
17"	16A	3 through 7	64-161	16B	8 through 12	64-162	16C	13 through 18	64-163
18"	17A	3 through 7	64-171	17B	8 through 12	64-172	17C	13 through 18	64-173
19"	18A	4 through 8	64-181	18B	9 through 12	64-182	18C	13 through 18	64-183
20"	19A	4 through 8	64-191	19B	9 through 12	64-192	19C	13 through 18	64-193
21"	20A	4 through 8	64-201	20B	9 through 13	64-202	20C	14 through 18	64-203
22"	21A	4 through 8	64-211	21B	9 through 13	64-212	21C	14 through 18	64-213
23"	22A	4 through 8	64-221	22B	9 through 12	64-222	22C	13 through 18	64-223
24"	23A	4 through 8	64-231	23B	9 through 13	64-232	23C	14 through 20	64-233
25"	24A	4 through 8	64-241	24B	9 through 13	64-242	24C	14 through 23	64-243
26"	25A	4 through 8	64-251	25B	9 through 14	64-252	25C	15 through 23	64-253
27"	26A	4 through 8	64-261	26B	9 through 14	64-262	26C	15 through 23	64-263
28"	27A	4 through 8	64-271	27B	9 through 14	64-272	27C	15 through 23	64-273
29"	28A	4 through 8	64-281	28B	9 through 14	64-282	28C	15 through 23	64-283
30"	29A	4 through 8	64-291	29B	9 through 14	64-292	29C	15 through 23	64-293
31"	30A	4 through 8	64-301	30B	9 through 14	64-302	30C	15 through 23	64-303
32"	31A	4 through 8	64-311	31B	9 through 14	64-312	31C	15 through 23	64-313
33"	32A	4 through 8	64-321	32B	9 through 14	64-322	32C	15 through 23	64-323
34"	33A	4 through 8	64-331	33B	9 through 14	64-332	33C	15 through 23	64-333
35"	34A	4 through 8	64-341	34B	9 through 14	64-342	34C	15 through 23	64-343
36"	35A	4 through 8	64-351	35B	9 through 14	64-352	35C	15 through 23	64-353
37"	36A	4 through 8	64-361	36B	9 through 14	64-362	36C	15 through 23	64-363
38"	37A	4 through 8	64-371	37B	9 through 14	64-372	37C	15 through 23	64-373

#### Ordering Information

- 1) Measure metal channel length (do not include plastic ends).
- 2) Identify number stamped on channel. (e.g. 19A, 22B, 28C, etc.)
- 3) Select our corresponding part number from the chart below.
- 4) Identify the top and bottom ends to be attached.

Note: Top and bottom balance ends must be ordered separately. If you want ends attached, add the letter "A" to the suffix of the part number when ordering.

Popular in Southeast; primarily used by Binnings and Moss.

## 64 SERIES BALANCES ACCESSORIES

### TOP BRACKETS

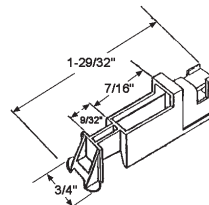

**900-15469  
LAWSON**

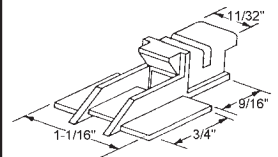

**64-506**

### TOP BRACKETS

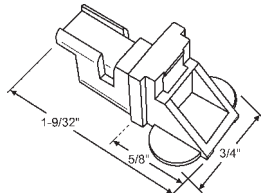

**64-508  
LAWSON**

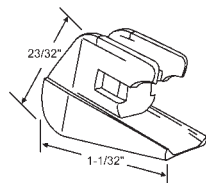

**64-502**

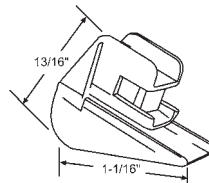

**64-503**

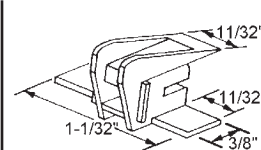

**64-505**

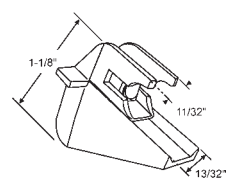

**900-15468  
LAWSON**

### BOTTOM BRACKETS

### BALANCE CLIP

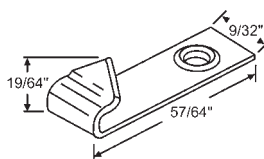

**60-518**

### RIVET



**64-504**  
3/32" Diameter 13/32" Length

### SASH GUIDES

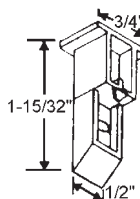

Part #	Color
64-600	White

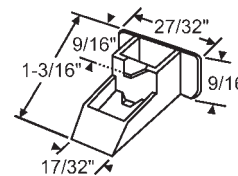

**64-602**  
White

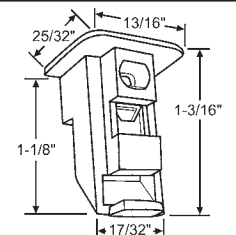

Part #	Color
64-601	White
64-601B	Black

# SASH SUPPORT SYSTEMS

## 64-841 SERIES RIBBED INVERTED TILT BALANCES

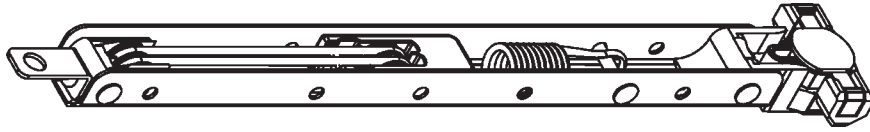
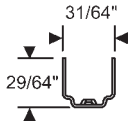

### Ordering Information

1. Measure metal channel length. (Do not include attached clip and T-Lock.)
2. Check number stamped on balance.
3. Select our corresponding part number from the chart below.
4. Select clip from list and add suffix to end of part number
5. Select the appropriate T-Lock from list and add suffix to end of part number

### Example Ordering Chart

Channel Length	Number Stamped on Balance	Our Part Number	Clip Attached	Tilt Lock Attached	Complete Part Number
24"	24A	64-841-24A	60-651	64-50000	64-841-24A-19Q

Length of Metal Channel	Number Stamped on Balance	Sash Weight	Our Part Number	Length of Metal Channel	Number Stamped on Balance	Sash Weight	Our Part Number	Length of Metal Channel	Number Stamped on Balance	Sash Weight	Our Part Number
8"	8A	4 - 6	64-841-8A	22"	22B	11 - 17	64-841-22B	32"	32F	33 - 36	64-841-32F
8"	8B	6 - 8	64-841-8B	22"	22C	17 - 21	64-841-22C	33"	33A	15 - 19	64-841-33A
8"	8C	8 - 10	64-841-8C	22"	22D	21 - 25	64-841-22D	33"	33B	19 - 23	64-841-33B
9"	9A	5 - 7	64-841-9A	22"	22E	25 - 28	64-841-22E	33"	33C	23 - 26	64-841-33C
9"	9B	7 - 9	64-841-9B	23"	23A	5 - 11	64-841-23A	33"	33D	26 - 30	64-841-33D
9"	9C	9 - 11	64-841-9C	23"	23B	11 - 17	64-841-23B	33"	33E	30 - 33	64-841-33E
10"	10A	5 - 8	64-841-10A	23"	23C	17 - 21	64-841-23C	33"	33F	33 - 36	64-841-33F
10"	10B	8 - 11	64-841-10B	23"	23D	21 - 25	64-841-23D	34"	34A	16 - 21	64-841-34A
10"	10C	11 - 14	64-841-10C	23"	23E	25 - 28	64-841-23E	34"	34B	21 - 25	64-841-34B
11"	11A	5 - 9	64-841-11A	24"	24A	5 - 13	64-841-24A	34"	34C	25 - 26	64-841-34C
11"	11B	9 - 13	64-841-11B	24"	24B	13 - 18	64-841-24B	34"	34D	26 - 30	64-841-34D
11"	11C	13 - 16	64-841-11C	24"	24C	18 - 22	64-841-24C	34"	34E	30 - 34	64-841-34E
12"	12A	5 - 9	64-841-12A	24"	24D	22 - 26	64-841-24D	34"	34F	34 - 36	64-841-34F
12"	12B	9 - 13	64-841-12B	24"	24E	26 - 29	64-841-24E	35"	35A	18 - 21	64-841-35A
12"	12C	13 - 16	64-841-12C	25"	25A	5 - 13	64-841-25A	35"	35B	21 - 24	64-841-35B
13"	13A	5 - 9	64-841-13A	25"	25B	13 - 19	64-841-25B	35"	35C	24 - 26	64-841-35C
13"	13B	9 - 13	64-841-13B	25"	25C	19 - 23	64-841-25C	35"	35D	26 - 30	64-841-35D
13"	13C	13 - 16	64-841-13C	25"	25D	23 - 27	64-841-25D	35"	35E	30 - 34	64-841-35E
13"	13D	16 - 18	64-841-13D	25"	25E	27 - 30	64-841-25E	36"	36A	18 - 21	64-841-36A
14"	14A	5 - 9	64-841-14A	26"	26A	6 - 14	64-841-26A	36"	36B	21 - 24	64-841-36B
14"	14B	9 - 13	64-841-14B	26"	26B	14 - 19	64-841-26B	36"	36C	24 - 26	64-841-36C
14"	14C	13 - 16	64-841-14C	26"	26C	19 - 23	64-841-26C	36"	36D	26 - 30	64-841-36D
14"	14D	16 - 18	64-841-14D	26"	26D	23 - 28	64-841-26D	37"	37A	18 - 21	64-841-37A
15"	15A	5 - 9	64-841-15A	26"	26E	28 - 31	64-841-26E	37"	37B	21 - 24	64-841-37B
15"	15B	9 - 13	64-841-15B	27"	27A	7 - 14	64-841-27A	37"	37C	24 - 26	64-841-37C
15"	15C	13 - 16	64-841-15C	27"	27B	14 - 20	64-841-27B	37"	37D	26 - 30	64-841-37D
15"	15D	16 - 18	64-841-15D	27"	27C	20 - 24	64-841-27C	38"	38A	18 - 21	64-841-38A
16"	16A	5 - 9	64-841-16A	27"	27D	24 - 28	64-841-27D	38"	38B	21 - 24	64-841-38B
16"	16B	9 - 14	64-841-16B	27"	27E	28 - 30	64-841-27E	38"	38C	24 - 26	64-841-38C
16"	16C	14 - 17	64-841-16C	28"	28A	8 - 14	64-841-28A	38"	38D	26 - 30	64-841-38D
16"	16D	17 - 20	64-841-16D	28"	28B	14 - 20	64-841-28B	39"	39A	18 - 21	64-841-39A
17"	17A	4 - 9	64-841-17A	28"	28C	20 - 23	64-841-28C	39"	39B	21 - 24	64-841-39B
17"	17B	9 - 14	64-841-17B	28"	28D	23 - 28	64-841-28D	39"	39C	24 - 26	64-841-39C
17"	17C	14 - 18	64-841-17C	28"	28E	28 - 30	64-841-28E	39"	39D	26 - 28	64-841-39D
17"	17D	18 - 20	64-841-17D	28"	28F	30 - 34	64-841-28F	40"	40A	18 - 21	64-841-40A
18"	18A	4 - 9	64-841-18A	29"	29A	9 - 15	64-841-29A	40"	40B	21 - 24	64-841-40B
18"	18B	9 - 15	64-841-18B	29"	29B	15 - 21	64-841-29B	40"	40C	24 - 26	64-841-40C
18"	18C	15 - 18	64-841-18C	29"	29C	21 - 26	64-841-29C	40"	40D	26 - 28	64-841-40D
18"	18D	18 - 20	64-841-18D	29"	29D	26 - 30	64-841-29D	41"	41A	18 - 21	64-841-41A
18"	18E	20 - 22	64-841-18E	29"	29E	30 - 33	64-841-29E	41"	41B	21 - 24	64-841-41B
19"	19A	3 - 9	64-841-19A	30"	30A	13 - 18	64-841-30A	41"	41C	24 - 26	64-841-41C
19"	19B	9 - 15	64-841-19B	30"	30B	18 - 23	64-841-30B	41"	41D	26 - 28	64-841-41D
19"	19C	15 - 18	64-841-19C	30"	30C	23 - 26	64-841-30C	42"	42A	18 - 21	64-841-42A
19"	19D	18 - 20	64-841-19D	30"	30D	26 - 30	64-841-30D	42"	42B	21 - 24	64-841-42B
19"	19E	20 - 22	64-841-19E	30"	30E	30 - 33	64-841-30E	42"	42C	24 - 26	64-841-42C
20"	20A	4 - 10	64-841-20A	30"	30F	33 - 35	64-841-30F	42"	42D	26 - 28	64-841-42D
20"	20B	10 - 16	64-841-20B	31"	31A	13 - 18	64-841-31A	43"	43A	18 - 21	64-841-43A
20"	20C	16 - 19	64-841-20C	31"	31B	18 - 23	64-841-31B	43"	43B	21 - 24	64-841-43B
20"	20D	19 - 22	64-841-20D	31"	31C	23 - 26	64-841-31C	43"	43C	24 - 26	64-841-43C
20"	20E	22 - 25	64-841-20E	31"	31D	26 - 30	64-841-31D	43"	43D	26 - 28	64-841-43D
21"	21A	4 - 10	64-841-21A	31"	31E	30 - 33	64-841-31E	44"	44A	18 - 21	64-841-44A
21"	21B	10 - 16	64-841-21B	32"	32A	15 - 20	64-841-32A	44"	44B	21 - 24	64-841-44B
21"	21C	16 - 20	64-841-21C	32"	32B	20 - 24	64-841-32B	44"	44C	24 - 26	64-841-44C
21"	21D	20 - 24	64-841-21D	32"	32C	24 - 27	64-841-32C	44"	44D	26 - 28	64-841-44D
21"	21E	24 - 27	64-841-21E	32"	32D	27 - 30	64-841-32D				
22"	22A	5 - 11	64-841-22A	32"	32E	30 - 33	64-841-32E				

Suffix -19

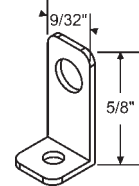

60-951  
Clip

Suffix -34

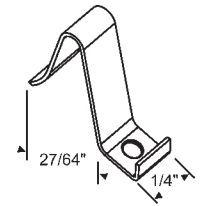

60-950  
Clip

Suffix -Q

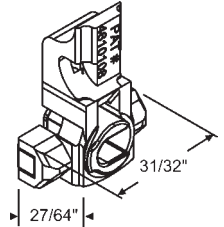

64-50000  
T-Lock. Beige

Suffix -AZ

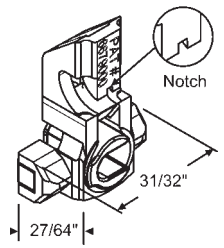

64-50001  
T-Lock. Black

### PIVOT BAR

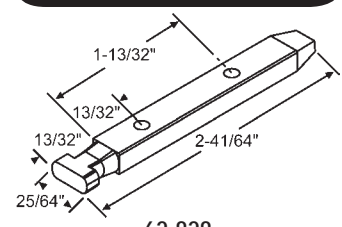

62-828  
Zinc



## 64B SERIES RIBBED TILT CHANNEL BALANCES

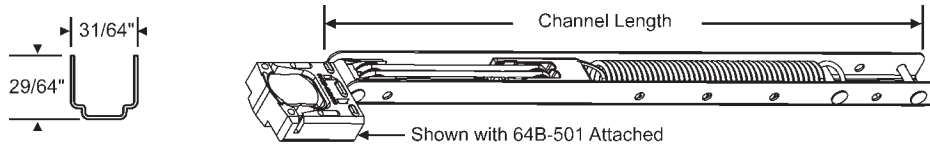

### Ordering Information

1. Measure metal channel balance length. (Do not include any attachments.)
2. Identify number stamped on channel. (e.g. 21A, 24B, etc.)
3. Select our corresponding part number from the chart below.
4. Identify the appropriate end to be attached from list and add the appropriate suffix. (e.g.. -1, -5, -22)
5. If white balance is needed add "W" to end of part number

### Example Ordering Chart

Length of Metal Channel	Number Stamped on Balance	Our Part Number	End Clip Combination	Color	Complete Part Number
21"	21A	64B-21A	-22	White	64B-21A-22W
24"	24B	64B-24B	-22	Mill	64B-21A-22

Length of Metal Channel	Number Stamped on Balance	Sash Weight	Our Part Number	Length of Metal Channel	Number Stamped on Balance	Sash Weight	Our Part Number	Length of Metal Channel	Number Stamped on Balance	Sash Weight	Our Part Number
8"	8A	4 - 6	64B-8A	22"	22B	11 - 17	64B-22B	32"	32F	33 - 36	64B-32F
8"	8B	6 - 8	64B-8B	22"	22C	17 - 21	64B-22C	33"	33A	15 - 19	64B-33A
8"	8C	8 - 10	64B-8C	22"	22D	21 - 25	64B-22D	33"	33B	19 - 23	64B-33B
9"	9A	5 - 7	64B-9A	22"	22E	25 - 28	64B-22E	33"	33C	23 - 26	64B-33C
9"	9B	7 - 9	64B-9B	23"	23A	5 - 11	64B-23A	33"	33D	26 - 30	64B-33D
9"	9C	9 - 11	64B-9C	23"	23B	11 - 17	64B-23B	33"	33E	30 - 33	64B-33E
10"	10A	5 - 8	64B-10A	23"	23C	17 - 21	64B-23C	33"	33F	33 - 36	64B-33F
10"	10B	8 - 11	64B-10B	23"	23D	21 - 25	64B-23D	34"	34A	16 - 21	64B-34A
10"	10C	11 - 14	64B-10C	23"	23E	25 - 28	64B-23E	34"	34B	21 - 25	64B-34B
11"	11A	5 - 9	64B-11A	24"	24A	5 - 13	64B-24A	34"	34C	25 - 26	64B-34C
11"	11B	9 - 13	64B-11B	24"	24B	13 - 18	64B-24B	34"	34D	26 - 30	64B-34D
11"	11C	13 - 16	64B-11C	24"	24C	18 - 22	64B-24C	34"	34E	30 - 34	64B-34E
12"	12A	5 - 9	64B-12A	24"	24D	22 - 26	64B-24D	34"	34F	34 - 36	64B-34F
12"	12B	9 - 13	64B-12B	24"	24E	26 - 29	64B-24E	35"	35A	18 - 21	64B-35A
12"	12C	13 - 16	64B-12C	25"	25A	5 - 13	64B-25A	35"	35B	21 - 24	64B-35B
13"	13A	5 - 9	64B-13A	25"	25B	13 - 19	64B-25B	35"	35C	24 - 26	64B-35C
13"	13B	9 - 13	64B-13B	25"	25C	19 - 23	64B-25C	35"	35D	26 - 30	64B-35D
13"	13C	13 - 16	64B-13C	25"	25D	23 - 27	64B-25D	35"	35E	30 - 34	64B-35E
13"	13D	16 - 18	64B-13D	25"	25E	27 - 30	64B-25E	36"	36A	18 - 21	64B-36A
14"	14A	5 - 9	64B-14A	26"	26A	6 - 14	64B-26A	36"	36B	21 - 24	64B-36B
14"	14B	9 - 13	64B-14B	26"	26B	14 - 19	64B-26B	36"	36C	24 - 26	64B-36C
14"	14C	13 - 16	64B-14C	26"	26C	19 - 23	64B-26C	36"	36D	26 - 30	64B-36D
14"	14D	16 - 18	64B-14D	26"	26D	23 - 28	64B-26D	37"	37A	18 - 21	64B-37A
15"	15A	5 - 9	64B-15A	26"	26E	28 - 31	64B-26E	37"	37B	21 - 24	64B-37B
15"	15B	9 - 13	64B-15B	27"	27A	7 - 14	64B-27A	37"	37C	24 - 26	64B-37C
15"	15C	13 - 16	64B-15C	27"	27B	14 - 20	64B-27B	37"	37D	26 - 30	64B-37D
15"	15D	16 - 18	64B-15D	27"	27C	20 - 24	64B-27C	38"	38A	18 - 21	64B-38A
16"	16A	5 - 9	64B-16A	27"	27D	24 - 28	64B-27D	38"	38B	21 - 24	64B-38B
16"	16B	9 - 14	64B-16B	27"	27E	28 - 30	64B-27E	38"	38C	24 - 26	64B-38C
16"	16C	14 - 17	64B-16C	28"	28A	8 - 14	64B-28A	38"	38D	26 - 30	64B-38D
16"	16D	17 - 20	64B-16D	28"	28B	14 - 20	64B-28B	39"	39A	18 - 21	64B-39A
17"	17A	4 - 9	64B-17A	28"	28C	20 - 23	64B-28C	39"	39B	21 - 24	64B-39B
17"	17B	9 - 14	64B-17B	28"	28D	23 - 28	64B-28D	39"	39C	24 - 26	64B-39C
17"	17C	14 - 18	64B-17C	28"	28E	28 - 30	64B-28E	39"	39D	26 - 28	64B-39D
17"	17D	18 - 20	64B-17D	28"	28F	30 - 34	64B-28F	40"	40A	18 - 21	64B-40A
18"	18A	4 - 9	64B-18A	29"	29A	9 - 15	64B-29A	40"	40B	21 - 24	64B-40B
18"	18B	9 - 15	64B-18B	29"	29B	15 - 21	64B-29B	40"	40C	24 - 26	64B-40C
18"	18C	15 - 18	64B-18C	29"	29C	21 - 26	64B-29C	40"	40D	26 - 28	64B-40D
18"	18D	18 - 20	64B-18D	29"	29D	26 - 30	64B-29D	41"	41A	18 - 21	64B-41A
18"	18E	20 - 22	64B-18E	29"	29E	30 - 33	64B-29E	41"	41B	21 - 24	64B-41B
19"	19A	3 - 9	64B-19A	30"	30A	13 - 18	64B-30A	41"	41C	24 - 26	64B-41C
19"	19B	9 - 15	64B-19B	30"	30B	18 - 23	64B-30B	41"	41D	26 - 28	64B-41D
19"	19C	15 - 18	64B-19C	30"	30C	23 - 26	64B-30C	42"	42A	18 - 21	64B-42A
19"	19D	18 - 20	64B-19D	30"	30D	26 - 30	64B-30D	42"	42B	21 - 24	64B-42B
19"	19E	20 - 22	64B-19E	30"	30E	30 - 33	64B-30E	42"	42C	24 - 26	64B-42C
20"	20A	4 - 10	64B-20A	30"	30F	33 - 35	64B-30F	42"	42D	26 - 28	64B-42D
20"	20B	10 - 16	64B-20B	31"	31A	13 - 18	64B-31A	43"	43A	18 - 21	64B-43A
20"	20C	16 - 19	64B-20C	31"	31B	18 - 23	64B-31B	43"	43B	21 - 24	64B-43B
20"	20D	19 - 22	64B-20D	31"	31C	23 - 26	64B-31C	43"	43C	24 - 26	64B-43C
20"	20E	22 - 25	64B-20E	31"	31D	26 - 30	64B-31D	43"	43D	26 - 28	64B-43D
21"	21A	4 - 10	64B-21A	31"	31E	30 - 33	64B-31E	44"	44A	18 - 21	64B-44A
21"	21B	10 - 16	64B-21B	32"	32A	15 - 20	64B-32A	44"	44B	21 - 24	64B-44B
21"	21C	16 - 20	64B-21C	32"	32B	20 - 24	64B-32B	44"	44C	24 - 26	64B-44C
21"	21D	20 - 24	64B-21D	32"	32C	24 - 27	64B-32C	44"	44D	26 - 28	64B-44D
21"	21E	24 - 27	64B-21E	32"	32D	27 - 30	64B-32D				
22"	22A	5 - 11	64B-22A	32"	32E	30 - 33	64B-32E				

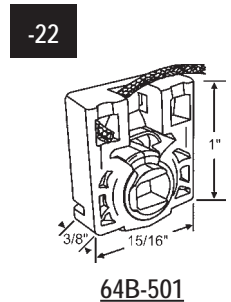
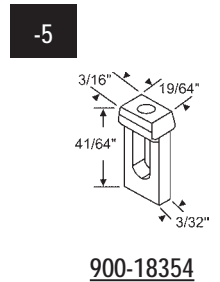
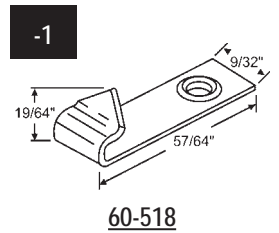

## 64T SERIES CHANNEL BALANCE

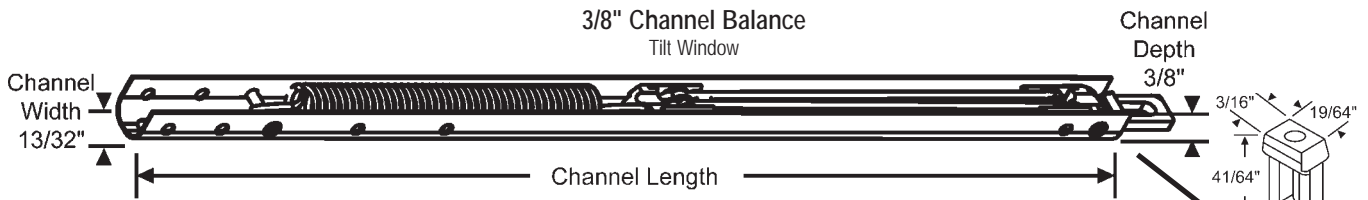

### INSTRUCTIONS

1. Measure metal channel length (do not include attached clip)
2. Check number stamped on balance
3. Select our corresponding part number from chart below
4. Select related accessories (see bottom of page)

**900-18354**  
Attached

Length of Metal Channel	Number Stamped on Balance	Sash Weight	Our Part Number	Length of Metal Channel	Number Stamped on Balance	Sash Weight	Our Part Number
11"	10A	2 - 4 lbs	64T-101-5	26"	25A	4 - 8 lbs	64T-251-5
11"	10B	4 - 7 lbs	64T-102-5	26"	25B	8 - 14 lbs	64T-252-5
11"	10C	7 - 12 lbs	64T-103-5	26"	25C	14 - 20 lbs	64T-253-5
12"	11A	3 - 6 lbs	64T-111-5	27"	26A	4 - 8 lbs	64T-261-5
12"	11B	6 - 9 lbs	64T-112-5	27"	26B	8 - 14 lbs	64T-262-5
12"	11C	9 - 12 lbs	64T-113-5	27"	26C	14 - 20 lbs	64T-263-5
13"	12A	3 - 7 lbs	64T-121-5	28"	27A	4 - 8 lbs	64T-271-5
13"	12B	7 - 12 lbs	64T-122-5	28"	27B	8 - 14 lbs	64T-272-5
13"	12C	12 - 15 lbs	64T-123-5	28"	27C	14 - 20 lbs	64T-273-5
14"	13A	3 - 7 lbs	64T-131-5	29"	28A	4 - 8 lbs	64T-281-5
14"	13B	7 - 12 lbs	64T-132-5	29"	28B	8 - 14 lbs	64T-282-5
14"	13C	12 - 15 lbs	64T-133-5	29"	28C	14 - 20 lbs	64T-283-5
15"	14A	3 - 7 lbs	64T-141-5	30"	29A	4 - 8 lbs	64T-291-5
15"	14B	7 - 12 lbs	64T-142-5	30"	29B	8 - 14 lbs	64T-292-5
15"	14C	12 - 16 lbs	64T-143-5	30"	29C	14 - 20 lbs	64T-293-5
16"	15A	3 - 7 lbs	64T-151-5	31"	30A	4 - 8 lbs	64T-301-5
16"	15B	7 - 12 lbs	64T-152-5	31"	30B	8 - 14 lbs	64T-302-5
16"	15C	12 - 16 lbs	64T-153-5	31"	30C	14 - 20 lbs	64T-303-5
17"	16A	3 - 7 lbs	64T-161-5	32"	31A	4 - 8 lbs	64T-311-5
17"	16B	7 - 12 lbs	64T-162-5	32"	31B	8 - 14 lbs	64T-312-5
17"	16C	12 - 18 lbs	64T-163-5	32"	31C	14 - 20 lbs	64T-313-5
18"	17A	3 - 7 lbs	64T-171-5	33"	32A	4 - 8 lbs	64T-321-5
18"	17B	7 - 12 lbs	64T-172-5	33"	32B	8 - 14 lbs	64T-322-5
18"	17C	12 - 18 lbs	64T-173-5	33"	32C	14 - 20 lbs	64T-323-5
19"	18A	4 - 8 lbs	64T-181-5	34"	33A	4 - 8 lbs	64T-331-5
19"	18B	8 - 12 lbs	64T-182-5	34"	33B	8 - 14 lbs	64T-332-5
19"	18C	12 - 18 lbs	64T-183-5	34"	33C	14 - 20 lbs	64T-333-5
20"	19A	4 - 8 lbs	64T-191-5	35"	34A	4 - 8 lbs	64T-341-5
20"	19B	8 - 12 lbs	64T-192-5	35"	34B	8 - 14 lbs	64T-342-5
20"	19C	12 - 18 lbs	64T-193-5	35"	34C	14 - 20 lbs	64T-343-5
21"	20A	4 - 8 lbs	64T-201-5	36"	35A	4 - 8 lbs	64T-351-5
21"	20B	8 - 13 lbs	64T-202-5	36"	35B	8 - 14 lbs	64T-352-5
21"	20C	13 - 18 lbs	64T-203-5	36"	35C	14 - 20 lbs	64T-353-5
22"	21A	4 - 8 lbs	64T-211-5	37"	36A	4 - 8 lbs	64T-361-5
22"	21B	8 - 13 lbs	64T-212-5	37"	36B	8 - 14 lbs	64T-362-5
22"	21C	13 - 18 lbs	64T-213-5	37"	36C	14 - 20 lbs	64T-363-5
23"	22A	4 - 8 lbs	64T-221-5	38"	37A	4 - 8 lbs	64T-371-5
23"	22B	8 - 12 lbs	64T-222-5	38"	37B	8 - 14 lbs	64T-372-5
23"	22C	12 - 18 lbs	64T-223-5	38"	37C	14 - 20 lbs	64T-373-5
24"	23A	4 - 8 lbs	64T-231-5	39"	38A	4 - 8 lbs	64T-381-5
24"	23B	8 - 13 lbs	64T-232-5	39"	38B	8 - 14 lbs	64T-382-5
24"	23C	13 - 20 lbs	64T-233-5	39"	38C	14 - 20 lbs	64T-383-5
25"	24A	4 - 8 lbs	64T-241-5				
25"	24B	8 - 13 lbs	64T-241-5				
25"	24C	13 - 20 lbs	64T-243-5				

## 64T SERIES TILT CHANNEL BALANCES ACCESSORIES

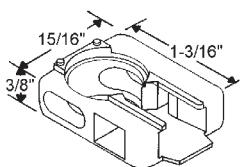

**64T-500**  
Terminal Housing



**64T-504**  
Brake Shoe

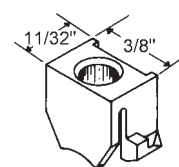

**64T-505**  
Pivot Retainer

## 70 SERIES BALANCES

### 5/8" TUBE BALANCE

Tube diameter 9/16" but considered 5/8" in the trade.

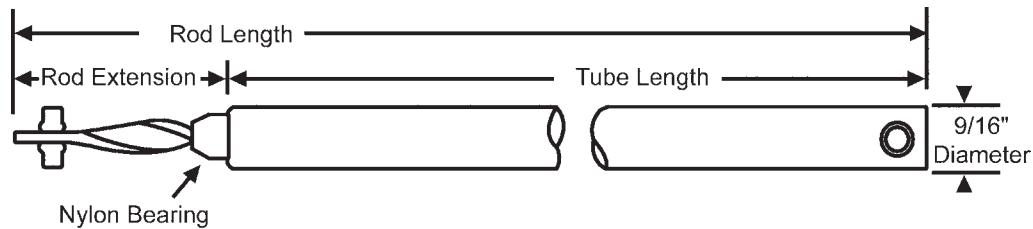

#### Ordering Information

- 1) Measure metal tube length. (Do not include nylon bearing.)
- 2) Measure spiral rod length. (Make sure rod is flush with screw hole end of tube before measuring.)
- 3) Identify the color of the bearing (e.g., white, red, blue or black) and select our corresponding part number from the chart below.
- 4) To identify any attaching brackets or accessories used with your balance, refer to pages 58-60.

**Note:** Brackets and accessories must be ordered separately.

#### General Information

- 1) Maximum tube balance length available is 60".
- 2) White, red and blue bearings are for sashes weighing up to 30 lbs; the black bearing with nyclud tip is for sashes weighing up to 40 lbs. Please consult your sales representative for special ordering information.
- 3) The appropriate tensioning tools are 70-515 and 70-516 as shown on pages 60 and 96.

#### Standard Rod

Tube Length	Rod Length	Red Bearing	Blue Bearing	Black Bearing
9"	9-3/4"	70-N9SR	---	---
10"	10-3/4"	70-N10SR	---	---
11"	11-3/4"	70-N11SR	---	---
12"	12-3/4"	70-N12SR	70-N12SB	---
13"	13-3/4"	70-N13SR	70-N13SB	---
14"	14-3/4"	70-N14SR	70-N14SB	---
15"	15-3/4"	70-N15SR	70-N15SB	---
16"	16-3/4"	70-N16SR	---	---
17"	17-3/4"	70-N17SR	70-N17SB	70-L17S
18"	18-3/4"	70-N18SR	70-N18SB	70-L18S
19"	19-3/4"	70-N19SR	70-N19SB	70-L19S
20"	20-3/4"	70-N20SR	70-N20SB	70-L20S
21"	21-3/4"	70-N21SR	70-N21SB	70-L21S
22"	22-3/4"	70-N22SR	70-N22SB	70-L22S
23"	23-3/4"	70-N23SR	70-N23SB	70-L23S
24"	24-3/4"	70-N24SR	70-N24SB	70-L24S
25"	25-3/4"	70-N25SR	70-N25SB	70-L25S
26"	26-3/4"	70-N26SR	70-N26SB	70-L26S
27"	27-3/4"	70-N27SR	70-N27SB	70-L27S
28"	28-3/4"	70-N28SR	70-N28SB	70-L28S
29"	29-3/4"	70-N29SR	70-N29SB	70-L29S
30"	30-3/4"	70-N30SR	70-N30SB	70-L30S
31"	31-3/4"	70-N31SR	70-N31SB	70-L31S
32"	32-3/4"	70-N32SR	70-N32SB	70-L32S
33"	33-3/4"	70-N33SR	---	70-L33S
34"	34-3/4"	70-N34SR	---	70-L34S
35"	35-3/4"	70-N35SR	---	70-L35S
36"	36-3/4"	70-N36SR	---	70-L36S
37"	37-3/4"	70-N37SR	---	70-L37S
38"	38-3/4"	70-N38SR	---	70-L38S
39"	39-3/4"	70-N39SR	---	70-L39S
40"	40-3/4"	70-N40SR	---	70-L40S
41"	41-3/4"	70-N41SR	---	70-L41S
42"	42-3/4"	70-N42SR	---	70-L42S
43"	43-3/4"	70-N43SR	---	70-L43S
44"	44-3/4"	70-N44SR	---	70-L44S
45"	45-3/4"	70-N45SR	---	70-L45S
46"	46-3/4"	70-N46SR	---	70-L46S
47"	47-3/4"	70-N47SR	---	70-L47S
48"	48-3/4"	70-N48SR	---	70-L48S
49"	49-3/4"	70-N49SR	---	70-L49S
50"	50-3/4"	70-N50SR	---	70-L50S

#### Extended Rod

Tube Length	Rod Length	Red Bearing	Blue Bearing
9"	10-3/4"	70-N9RR	---
10"	11-3/4"	70-N10RR	---
11"	12-3/4"	70-N11RR	---
12"	13-3/4"	70-N12RR	70-N12RB
13"	14-3/4"	70-N13RR	70-N13RB
14"	15-3/4"	70-N14RR	70-N14RB
15"	16-3/4"	70-N15RR	70-N15RB
16"	17-3/4"	70-N16RR	70-N16RB
17"	18-3/4"	70-N17RR	70-N17RB
18"	19-3/4"	70-N18RR	70-N18RB
19"	20-3/4"	70-N19RR	70-N19RB
20"	21-3/4"	70-N20RR	70-N20RB
21"	22-3/4"	70-N21RR	70-N21RB
22"	23-3/4"	70-N22RR	70-N22RB
23"	24-3/4"	70-N23RR	70-N23RB
24"	25-3/4"	70-N24RR	70-N24RB
25"	26-3/4"	70-N25RR	70-N25RB
26"	27-3/4"	70-N26RR	70-N26RB
27"	28-3/4"	70-N27RR	70-N27RB
28"	29-3/4"	70-N28RR	70-N28RB
29"	30-3/4"	70-N29RR	70-N29RB
30"	31-3/4"	70-N30RR	70-N30RB
31"	32-3/4"	70-N31RR	70-N31RB
32"	33-3/4"	70-N32RR	70-N32RB
33"	34-3/4"	70-N33RR	---
34"	35-3/4"	70-N34RR	---
35"	36-3/4"	70-N35RR	---
36"	37-3/4"	70-N36RR	---
37"	38-3/4"	70-N37RR	---
38"	39-3/4"	70-N38RR	---
39"	40-3/4"	70-N39RR	---
40"	41-3/4"	70-N40RR	---
41"	42-3/4"	70-N41RR	---
42"	43-3/4"	70-N42RR	---
43"	44-3/4"	70-N43RR	---
44"	45-3/4"	70-N44RR	---
45"	46-3/4"	70-N45RR	---
46"	47-3/4"	70-N46RR	---
47"	48-3/4"	70-N47RR	---
48"	49-3/4"	70-N48RR	---
49"	50-3/4"	70-N49RR	---
50"	51-3/4"	70-N50RR	---

# SASH SUPPORT SYSTEMS

## 70 SERIES BALANCE ACCESSORIES

### METAL BRACKETS

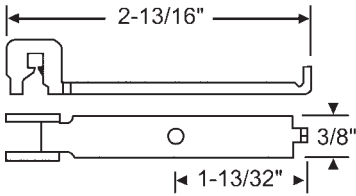

Part #	Description
70-503	Metal
70-503SS	Stainless Steel

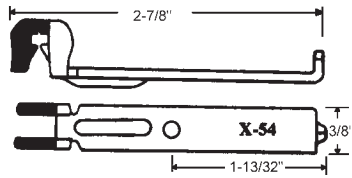

Part #	Description
70-502N	Nyclad Coated
70-502	Not Coated

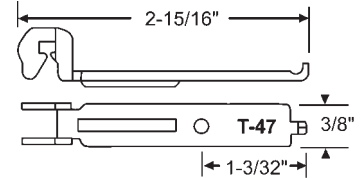

**70-501**

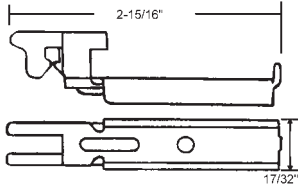

**70-504**

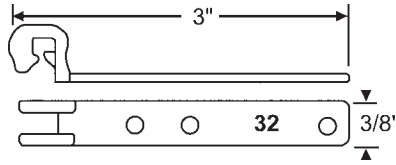

**70-500**

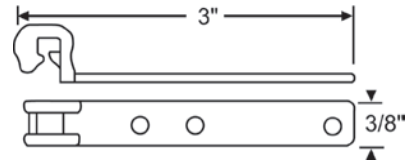

**70-524**

Used with Retainer Guide 70-626

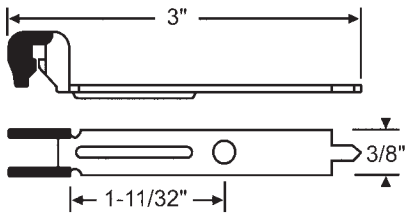

**70-534N**  
Nyclad Coated

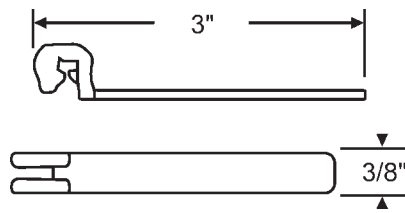

**70-526**

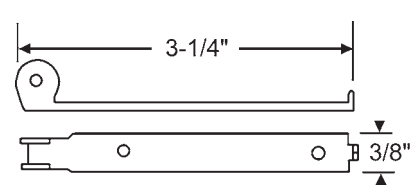

**70-523**  
Riveted Type  
Used with Rivet 74-509

### BALANCE SHOES

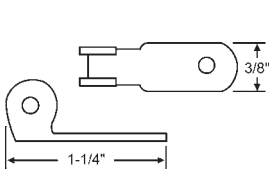

**70-523C**

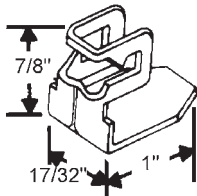

**70-521**  
Metal  
**ALWINSEAL**

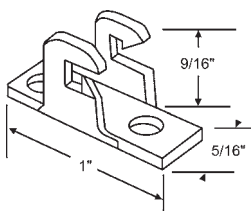

Part #	Description
70-505	Metal
70-505SS	Stainless Steel

Side Mount

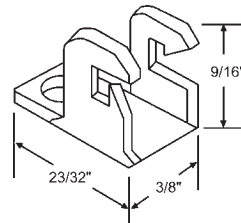

**70-506**  
Metal  
Side Mount

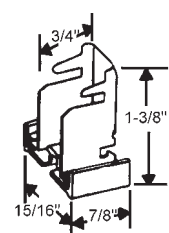

Part #	Hand
70-514RH	Shown

**STANLEY**

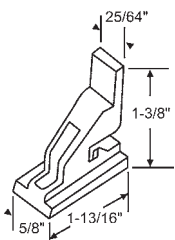

**70-510**  
**TUCKER/**  
**GEORGIA PALM BEACH**

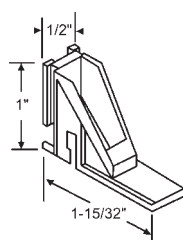

**70-513**  
Use with 70-600 Sash Clip  
**ABC/HARCAR**

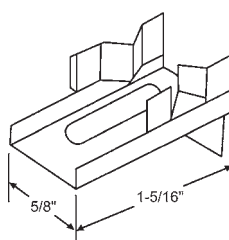

**70-600**  
Metal Sash Clip for 70-513  
**ABC/HARCAR**

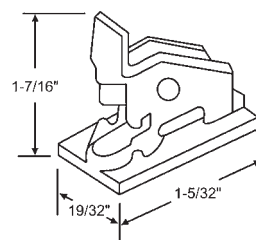

**70-509**  
**TUCKER/**  
**GEORGIA PALM BEACH**

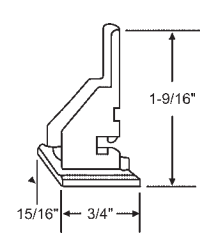

**70-508**  
Use with 70-629 Retainer  
**CROSSLY**

## 70 SERIES BALANCE ACCESSORIES

### BALANCE SHOES

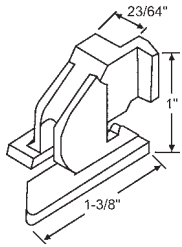

**70-511A**  
Sold in Sets Only  
**CUPPLES**

### BALANCE BRACKET

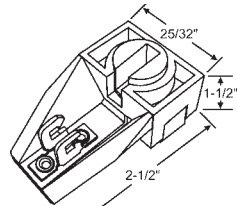

**900-10697A**  
Balance Bracket Assembly w/  
Cam and Pawl  
**SWS**

### TOP SASH CAMS

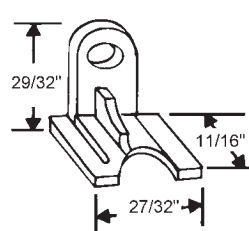

**70-602**

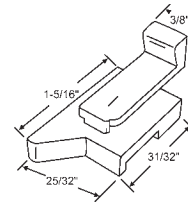

Part #	Hand
70-615	Shown
70-616	Opposite

Black, Plastic  
**CALCO ALUM. CO.**

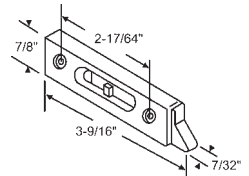

Part #	Hand
70-617	Shown
70-618	Opposite

Top Sash Cam Assembly  
New Style, Black  
**CALCO ALUM. CO.**

### BALANCE CAPS

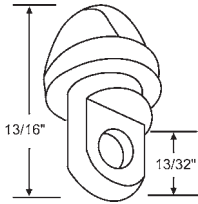

**70-517**

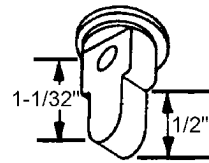

**70-528**  
**GEORGIA PALM BEACH**

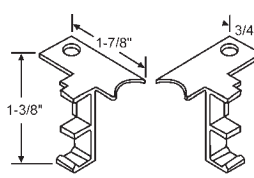

**70-627**  
Two Piece  
Die Cast

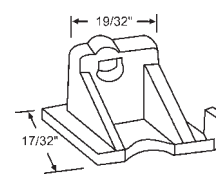

**70-606A**  
Sold in Sets Only. Nylon  
**CROSSLY**

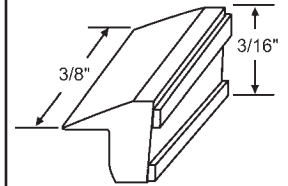

**70-624**  
Nylon

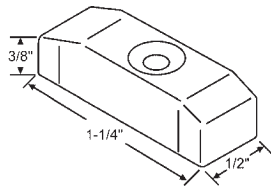

**900-5095**  
Nylon

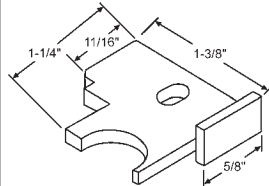

**70-639**  
Nylon

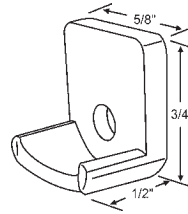

**70-603**  
White Plastic  
**GEORGIA PALM BEACH**

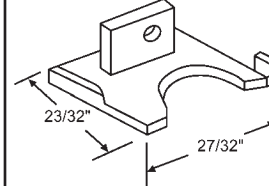

**70-612**  
Sold in Sets Only. RH Shown.  
Nylon. Use with Balance Shoes  
70-514LH & RH  
**STANLEY**

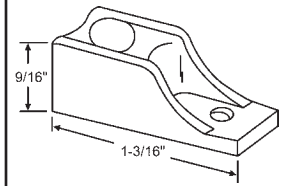

**70-620**  
Nylon

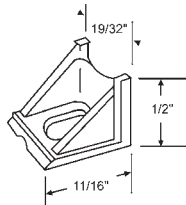

**70-601**  
Off White Plastic

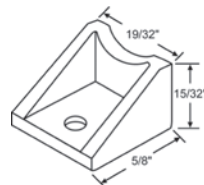

**70-605**  
Gray Plastic

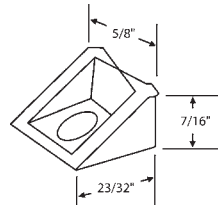

**70-625**  
Nylon

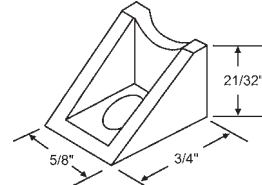

**70-635**  
Nylon

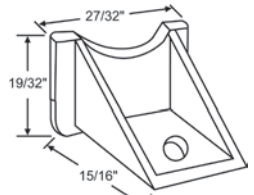

**70-622**  
Nylon

### SCREW BUSHING

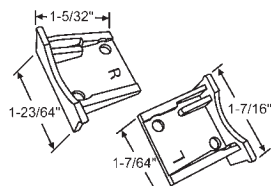

**70-655B**  
Sash Guide Set. Black  
**PGT**

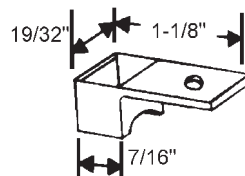

**70-623**  
Nylon. Use with 72-500 Carrier  
and 72-603 Sash Clip

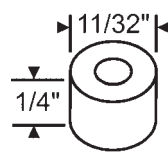

**62-613**  
Used with Screw 20-048  
**CALCO ALUM. CO.**

### RETAINER

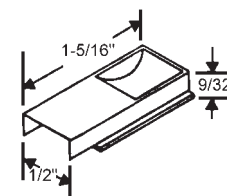

**70-629**  
Nylon

### TILT PIVOT

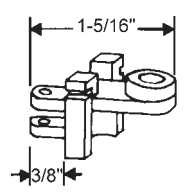

**70-519**  
Black Plastic  
**CALCO ALUM. CO.**

# SASH SUPPORT SYSTEMS

## 70 SERIES BALANCE ACCESSORIES

### SASH STOPS

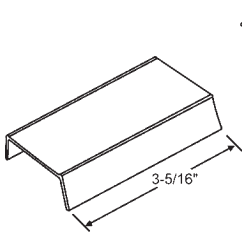

**70-712**  
Black  
**YALE/ OGRON**

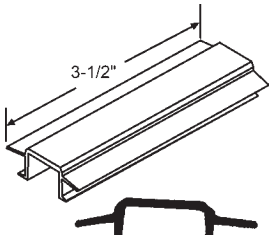

**900-20095BE-3.5**  
Beige, Plastic

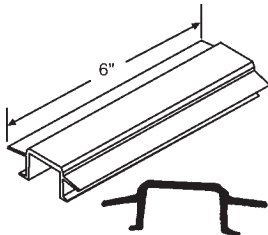

Part #	Color
900-20095W	White
900-20095	Beige
900-20095B	Black

Plastic

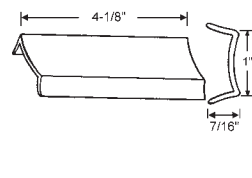

**70-702**  
White Plastic

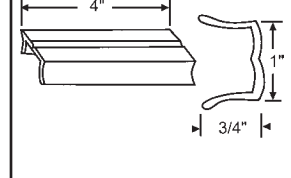

**70-700**  
White Plastic

### BALANCE TENSION TOOLS

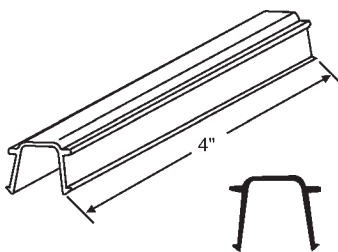

Part #	Color
70-710B	Black
70-710	White

Plastic

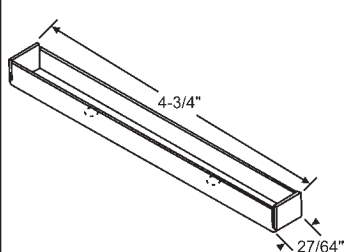

**70-707**  
Metal

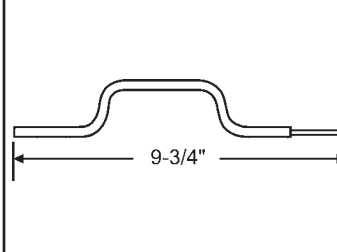

**70-515**

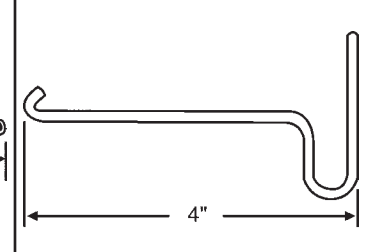

**70-516**

### BALANCE EXTENDER TOOL

### INSTALLATION KIT

### MISCELLANEOUS ACCESSORIES

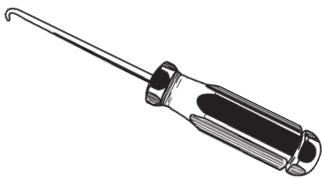

**59-42**

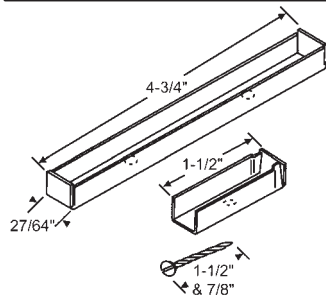

**70-708**  
For Stop/Balance bracket installation.  
Contains: brackets and assorted screws  
and nails; enough for 1 window.

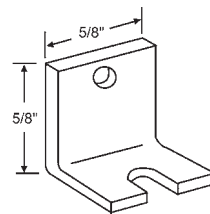

**70-704**  
Metal Angle Clip  
**GEORGIA PALM BEACH**

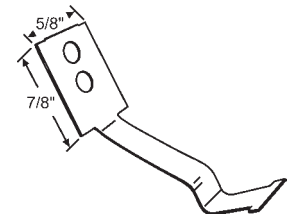

**70-705**  
Metal Vent Spring  
**GEORGIA PALM BEACH**

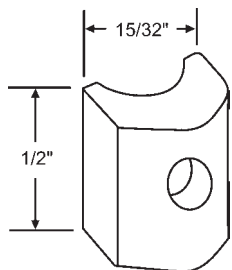

**70-709**  
Nylon Backing Block  
**GEORGIA PALM BEACH**

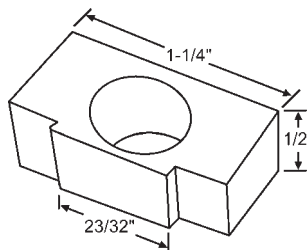

Part #	Color
900-11391	White

Rubber Balance Plug

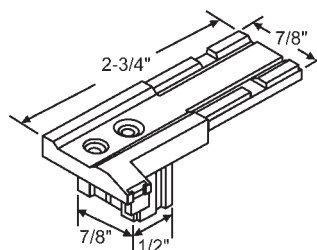

Part #	Hand
900-2350	Shown
900-2349	Opposite

Corner Assembly, Black Plastic

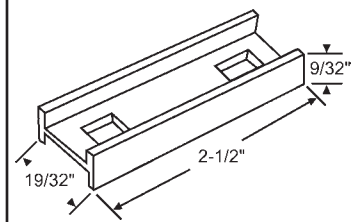

**70-604**  
Sash Carrier Lock, Aluminum  
**GEORGIA PALM BEACH**

## 72 SERIES BALANCES

### 5/8" TUBE BALANCE

Tube diameter 9/16" but considered 5/8" in the trade.

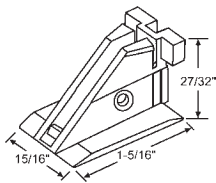

**Balance Carrier**

See page 62

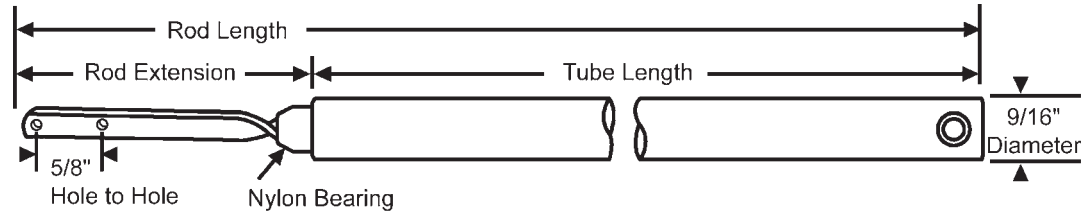

#### Ordering Information

- 1) Measure metal tube length (Do not include nylon bearing).
- 2) Measure spiral rod length (Make sure rod is flush with screw hole end of tube before measuring).
- 3) Identify the color of the bearing (e.g., white, red or blue) and select our corresponding part number from the chart below.
- 4) To identify the appropriate carrier or shoe to be attached and other related accessories, see page 62.

Note: Attached carriers and related accessories must be ordered separately. If you want the ends attached, add the letter "A" to the suffix of the accessory part number when ordering.

#### Standard Rod

Tube Length	Rod Length	White Bearing	Red Bearing
10"	11-5/8"	72-P10SW	---
11"	12-5/8"	72-P11SW	---
12"	13-5/8"	72-P12SW	72-P12SR
13"	14-5/8"	72-P13SW	72-P13SR
14"	15-5/8"	72-P14SW	72-P14SR
15"	16-5/8"	72-P15SW	72-P15SR
16"	17-5/8"	---	72-P16SR
17"	18-5/8"	---	72-P17SR
18"	19-5/8"	---	72-P18SR
19"	20-5/8"	---	72-P19SR
20"	21-5/8"	---	72-P20SR
21"	22-5/8"	---	72-P21SR
22"	23-5/8"	---	72-P22SR
23"	24-5/8"	---	72-P23SR
24"	25-5/8"	---	72-P24SR
25"	26-5/8"	---	72-P25SR
26"	27-5/8"	---	72-P26SR
27"	28-5/8"	---	72-P27SR
28"	29-5/8"	---	72-P28SR
29"	30-5/8"	72-P29SW	72-P29SR
30"	31-5/8"	---	72-P30SR
31"	32-5/8"	72-P31SW	72-P31SR
32"	33-5/8"	---	72-P32SR
33"	34-5/8"	---	72-P33SR
34"	35-5/8"	---	72-P34SR
35"	36-5/8"	72-P35SW	72-P35SR
36"	37-5/8"	---	72-P36SR
37"	38-5/8"	72-P37SW	72-P37SR
38"	39-5/8"	72-P38SW	72-P38SR
39"	40-5/8"	---	72-P39SR
40"	41-5/8"	72-P40SW	72-P40SR
41"	42-5/8"	72-P41SW	72-P41SR
42"	43-5/8"	72-P42SW	72-P42SR
43"	44-5/8"	---	72-P43SR
44"	45-5/8"	72-P44SW	72-P44SR
45"	46-5/8"	72-P45SW	72-P45SR
46"	47-5/8"	72-P46SW	72-P46SR
47"	48-5/8"	72-P47SW	72-P47SR
48"	49-5/8"	72-P48SW	72-P48SR
49"	50-5/8"	72-P49SW	72-P49SR
50"	51-5/8"	72-P50SW	72-P50SR

#### Extended Rod

Tube Length	Rod Length	White Bearing	Red Bearing
10"	12-5/8"	72-P10RW	---
11"	13-5/8"	72-P11RW	---
12"	14-5/8"	72-P12RW	72-P12RR
13"	15-5/8"	---	72-P13RR
14"	16-5/8"	72-P14RW	72-P14RR
15"	17-5/8"	72-P15RW	72-P15RR
16"	18-5/8"	---	72-P16RR
17"	19-5/8"	---	72-P17RR
18"	20-5/8"	---	72-P18RR
19"	21-5/8"	---	72-P19RR
20"	22-5/8"	---	72-P20RR
21"	23-5/8"	---	72-P21RR
22"	24-5/8"	---	72-P22RR
23"	25-5/8"	---	72-P23RR
24"	26-5/8"	---	72-P24RR
25"	27-5/8"	---	72-P25RR
26"	28-5/8"	---	72-P26RR
27"	29-5/8"	---	72-P27RR
28"	30-5/8"	---	72-P28RR
29"	31-5/8"	---	72-P29RR
30"	32-5/8"	72-P30RW	72-P30RR
31"	33-5/8"	72-P31RW	72-P31RR
32"	34-5/8"	72-P32RW	72-P32RR
33"	35-5/8"	72-P33RW	72-P33RR
34"	36-5/8"	72-P34RW	72-P34RR
35"	37-5/8"	72-P35RW	72-P35RR
36"	38-5/8"	72-P36RW	72-P36RR
37"	39-5/8"	72-P37RW	72-P37RR
38"	40-5/8"	---	72-P38RR
39"	41-5/8"	---	72-P39RR
40"	42-5/8"	---	72-P40RR
41"	43-5/8"	---	72-P41RR
42"	44-5/8"	72-P42RW	72-P42RR
43"	45-5/8"	72-P43RW	72-P43RR
44"	46-5/8"	72-P44RW	72-P44RR
45"	47-5/8"	72-P45RW	72-P45RR
46"	48-5/8"	72-P46RW	72-P46RR
47"	49-5/8"	72-P47RW	72-P47RR
48"	50-5/8"	72-P48RW	72-P48RR
49"	51-5/8"	72-P49RW	72-P49RR
50"	52-5/8"	72-P50RW	72-P50RR

An extra long extended rod is available with red bearings on the following sizes only:

#### Double Extended Rod

Tube Length	Rod Length	Part Number
15"	18-5/8"	72-P15RRR
19"	22-5/8"	72-P19RRR
21"	24-5/8"	72-P21RRR
23"	26-5/8"	72-P23RRR
27"	30-5/8"	72-P27RRR
33"	36-5/8"	72-P33RRR

#### Used Primarily by Keller

- The appropriate tensioning tools are 70-515 and 70-516 as shown on pages 60 and 96.
- Many customers confuse this series with our 85 tilt series on page 79.
- 72 series always comes with a plastic guide attachment to the 2nd hole.

Note: Mostly "red bearings" are used for repairs. "Blue bearings" were not used on original windows but used when heavier glass was added. Blue bearing balances can be special ordered.

# SASH SUPPORT SYSTEMS

## 72 SERIES BALANCE ACCESSORIES

### CARRIERS

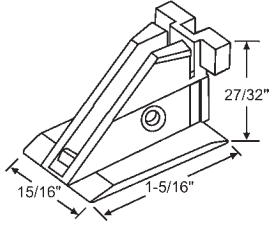

Part #	Color
72-500	White

#### PORTALUME

Part #	Color
72-501	Black

#### KELLER

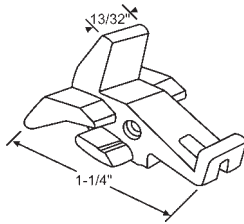

**72-503**  
White  
**SILVERLINE**

### RIVETS



**72-504**  
3/32" Diameter  
3/8" Length



**72-502**  
5/64" Diameter  
3/8" Length

### TOP SASH GUIDE

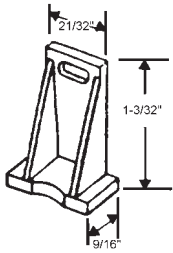

**72-604**

#### KELLER

### SASH CLIPS

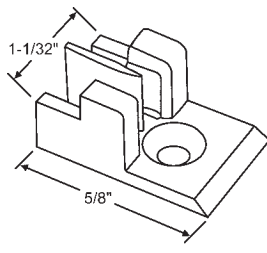

**72-607**

#### HOWARD

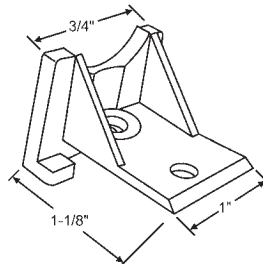

Part #	Hand
72-609	Shown
72-608	Opposite

#### HOWARD

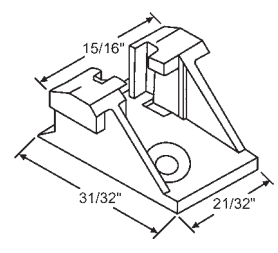

**72-605A**

Sold in Sets Only

#### KELLER

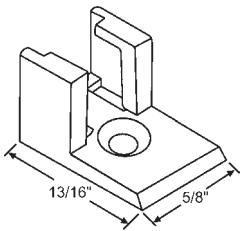

**72-600**

#### PORTALUME

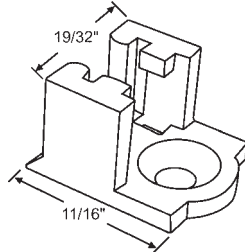

**72-601**

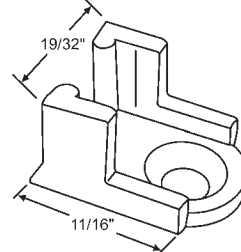

**72-602**

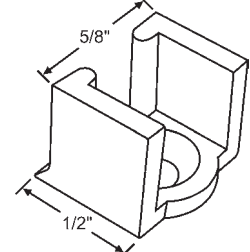

**72-603**

Sash clip

### BUSHING

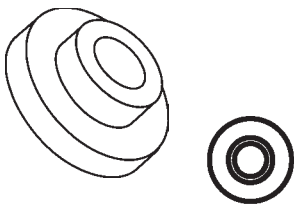

**72-800**

### BALANCE CAP

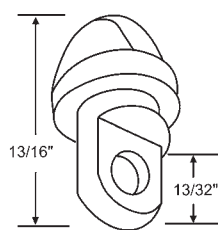

**70-517**

### SIDE RAIL GUIDE

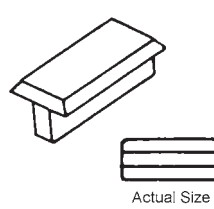

Part #	Finish
72-802	White
72-803	Black

### RETAINER

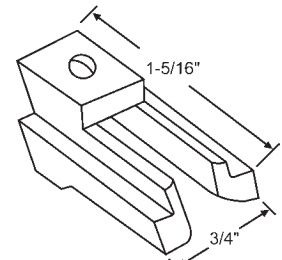

**74-715**

Nylon, White

#### AIR CONTROL



## 74 SERIES BALANCES

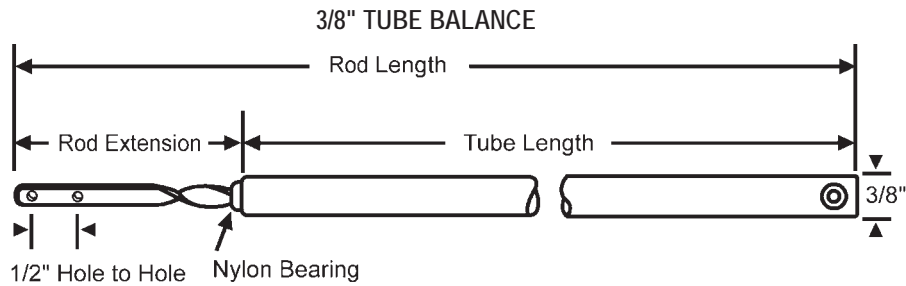
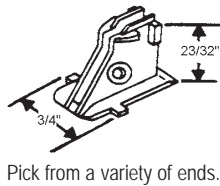

### Ordering Information

- 1) Measure metal tube length (Do not include nylon bearing).
- 2) Measure spiral rod length. (Make sure rod is flush with screw hole end of tube before measuring.)
- 3) Identify the color of the bearing (e.g., white, red or blue) and select our corresponding part number from the chart below.
- 4) To identify the appropriate carrier or shoe to be attached and other related accessories, see page 64.

Note: Attached carriers and related accessories must be ordered separately. If you want the ends attached, add the letter "A" to the suffix of the part number when ordering.

### General Information

- 1) White, red and blue bearings are for sashes weighing up to 22 lbs; green bearings are for sashes weighing up to 26 lbs. Consult your sales representative for ordering information.
- 2) The appropriate tensioning tools are 70-515 and 70-516 as shown on pages 60 and 96.

This series always comes with a shoe or bracket attached. Some customers confuse this series with our 83 series tilt balances on page 73.

### Standard Rod

Tube Length	Rod Length	White Bearing	Red Bearing	Blue Bearing	Green* Bearing
10"	10-3/4"	74-S10	---	---	---
11"	11-3/4"	74-S11	---	---	---
12"	12-3/4"	74-S12	---	---	---
13"	13-3/4"	74-S13	74-S13R	---	---
14"	14-3/4"	74-S14	74-S14R	---	---
15"	15-3/4"	74-S15	74-S15R	74-S15B	---
16"	16-3/4"	---	74-S16R	74-S16B	---
17"	17-3/4"	---	74-S17R	74-S17B	---
18"	18-3/4"	---	74-S18R	74-S18B	---
19"	19-3/4"	---	74-S19R	74-S19B	---
20"	20-3/4"	---	74-S20R	74-S20B	---
21"	21-3/4"	---	74-S21R	74-S21B	---
22"	22-3/4"	---	74-S22R	74-S22B	---
23"	23-3/4"	---	74-S23R	74-S23B	74-S23G
24"	24-3/4"	---	74-S24R	74-S24B	---
25"	25-3/4"	---	74-S25R	74-S25B	74-S25G
26"	26-3/4"	---	74-S26R	---	---
27"	27-3/4"	74-S27	74-S27R	---	---
28"	28-3/4"	---	74-S28R	---	74-S28G
29"	29-3/4"	---	74-S29R	---	74-S29G
30"	30-3/4"	---	74-S30R	---	74-S30G
31"	31-3/4"	---	74-S31R	---	---
32"	32-3/4"	---	74-S32R	---	---
33"	33-3/4"	74-S33	---	---	---
34"	34-3/4"	74-S34	---	---	74-S34G
35"	35-3/4"	74-S35	---	---	---
36"	36-3/4"	74-S36	---	---	74-S36G
37"	37-3/4"	74-S37	---	---	---
38"	38-3/4"	74-S38	---	---	---
39"	39-3/4"	74-S39	---	---	---
40"	40-3/4"	74-S40	---	---	---

### Extended Rod

Tube Length	Rod Length	White Bearing	Red Bearing	Blue Bearing	Green* Bearing
10"	11-3/4"	74-10	---	---	---
11"	12-3/4"	---	---	---	---
12"	13-3/4"	74-12	---	---	---
13"	14-3/4"	74-13	74-13R	---	---
14"	15-3/4"	74-14	74-14R	---	---
15"	16-3/4"	74-15	74-15R	74-15B	---
16"	17-3/4"	---	74-16R	74-16B	---
17"	18-3/4"	---	74-17R	74-17B	---
18"	19-3/4"	---	74-18R	74-18B	---
19"	20-3/4"	---	74-19R	74-19B	---
20"	21-3/4"	---	74-20R	74-20B	---
21"	22-3/4"	---	74-21R	74-21B	---
22"	23-3/4"	---	74-22R	74-22B	---
23"	24-3/4"	---	74-23R	74-23B	---
24"	25-3/4"	---	74-24R	74-24B	---
25"	26-3/4"	---	74-25R	74-25B	---
26"	27-3/4"	---	74-26R	---	---
27"	28-3/4"	---	74-27R	---	---
28"	29-3/4"	---	74-28R	---	74-28G
29"	30-3/4"	---	74-29R	---	74-29G
30"	31-3/4"	74-30	74-30R	---	74-30G
31"	32-3/4"	74-31	74-31R	---	74-31G
32"	33-3/4"	74-32	74-32R	---	---
33"	34-3/4"	74-33	---	---	---
34"	35-3/4"	74-34	---	---	---
35"	36-3/4"	74-35	---	---	---
36"	37-3/4"	74-36	---	---	---
37"	38-3/4"	74-37	---	---	---
38"	39-3/4"	74-38	---	---	---
39"	40-3/4"	74-39	---	---	---
40"	41-3/4"	74-40	---	---	---

\*Other sizes available upon request.

# SASH SUPPORT SYSTEMS

## 74 SERIES BALANCE ACCESSORIES

### CARRIERS

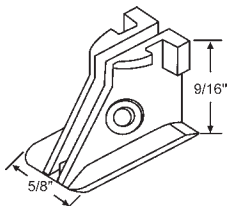

**74-501**

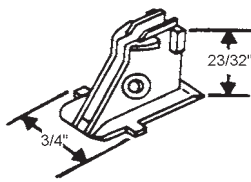

**74-502  
AIRMASTER**

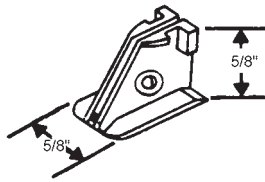

**74-503  
KELLER**

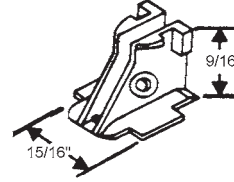

**74-504**

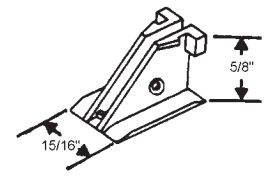

**74-510  
KELLER**

### BALANCE CAP

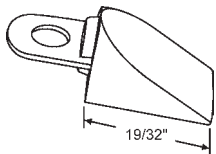

**74-505**

### BALANCE SHOE

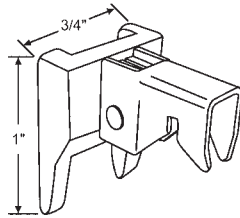

**74-508  
LOOK**

### RIVETS

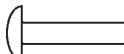

**74-509**  
3/32" Diameter  
13/32" Length



**74-500**  
3/32" Diameter  
9/32" Length

### NYLON RETAINER

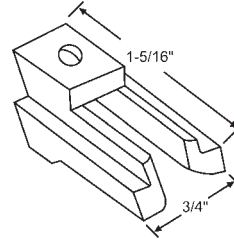

**74-715**  
Nylon, White  
All metal retainers are  
obsolete. 74-715 will work  
in most applications.

### TOP SASH GUIDES

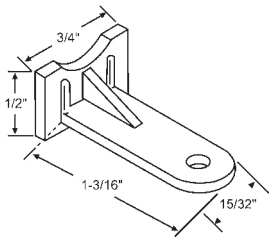

**900-5955**

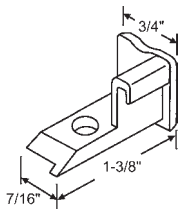

**74-602A**  
Set, LH and RH  
**AIRMASTER**

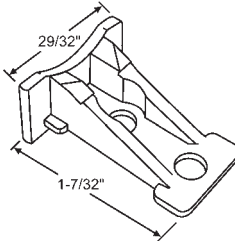

**74-607  
KELLER**

### FACE GUIDE

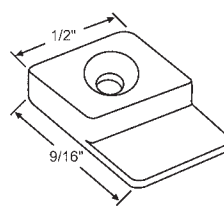

**76-600**  
Uses Screw 20-004

### ROUND FACE GUIDE

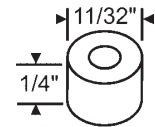

**62-613**  
Nylon Bushing  
**KELLER**

### WINDOW GUIDE

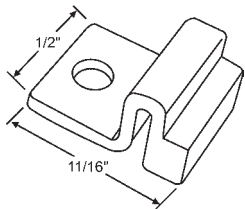

**74-612**

### SASH STOP

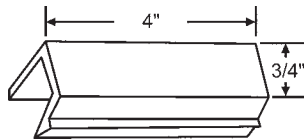

**74-713**  
White

### SASH CLIPS

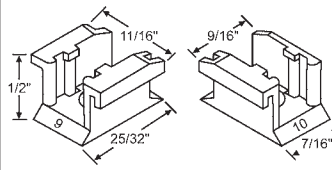

**74-600A**  
Set, LH and RH  
**AIRMASTER**

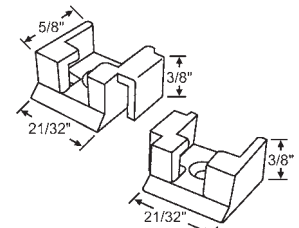

**74-611**  
Set, LH and RH  
**KELLER**

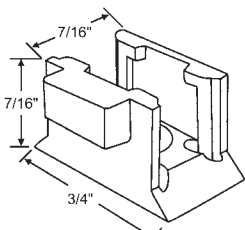

**74-604**

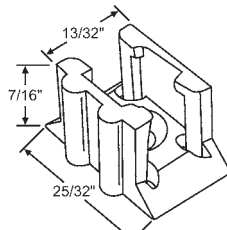

**74-605**

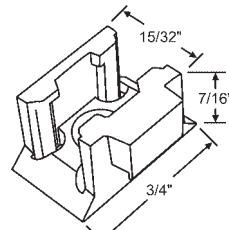

**74-606**

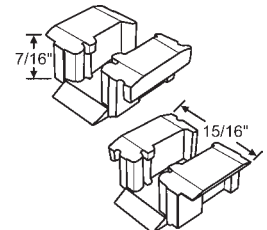

**74-609  
KELLER**

## 75 SERIES BALANCES

### 3/8" TUBE BALANCE

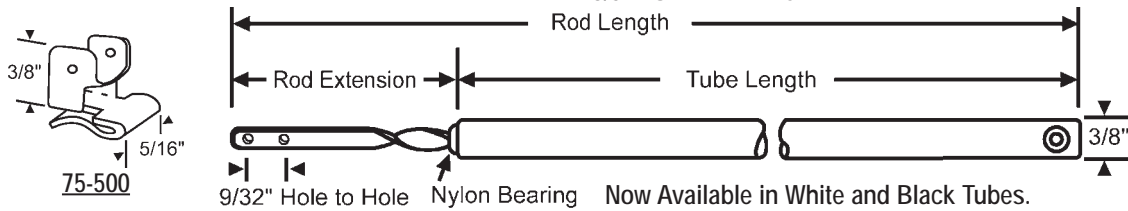

Note: The difference between our "74" and "75" series balances is in the hole center distance in the spiral rod.

#### Ordering Information

1. Measure metal tube length. (Do not include nylon bearing.)
2. Measure spiral rod length. (Make sure rod is flush with screw hole end of tube before measuring.)
3. Identify the color of the bearing (e.g., white, red or blue) and select our corresponding part number from the chart below.
4. To identify the appropriate carrier or shoe to be attached and other related accessories, see bottom of the page.

Note: Attached carriers and related accessories must be ordered separately. If you want the ends attached, add the letter "A" to the suffix of the part number when ordering.

#### Standard Rod

Tube Length	Rod Length	White Bearing	Red Bearing	Blue Bearing	Green Bearing*
10"	10-9/16"	75-S10	---	---	---
11"	11-9/16"	75-S11	---	---	---
12"	12-9/16"	75-S12	---	---	---
13"	13-9/16"	75-S13	75-S13R	---	---
14"	14-9/16"	75-S14	75-S14R	---	---
15"	15-9/16"	75-S15	75-S15R	75-S15B	---
16"	16-9/16"	---	75-S16R	75-S16B	---
17"	17-9/16"	---	75-S17R	75-S17B	---
18"	18-9/16"	---	75-S18R	75-S18B	75-S18G
19"	19-9/16"	75-S19	75-S19R	75-S19B	75-S19G
20"	20-9/16"	75-S20	75-S20R	75-S20B	---
21"	21-9/16"	75-S21	75-S21R	75-S21B	---
22"	22-9/16"	75-S22	75-S22R	75-S22B	75-S22G
23"	23-9/16"	75-S23	75-S23R	75-S23B	75-S23G
24"	24-9/16"	75-S24	75-S24R	75-S24B	75-S24G
25"	25-9/16"	75-S25	75-S25R	75-S25B	---
26"	26-9/16"	75-S26	75-S26R	---	---
27"	27-9/16"	75-S27	75-S27R	---	---
28"	28-9/16"	75-S28	75-S28R	---	75-S28G
29"	29-9/16"	---	75-S29R	---	75-S29G
30"	30-9/16"	75-S30	75-S30R	---	75-S30G
31"	31-9/16"	---	75-S31R	---	75-S31G
32"	32-9/16"	75-S32	75-S32R	---	---
33"	33-9/16"	75-S33	---	---	---
34"	34-9/16"	75-S34	---	---	---
35"	35-9/16"	75-S35	---	---	75-S35G
36"	36-9/16"	75-S36	---	---	75-S36G
37"	37-9/16"	75-S37	---	---	---
38"	38-9/16"	75-S38	---	---	---
39"	39-9/16"	75-S39	---	---	---
40"	40-9/16"	75-S40	---	---	---

#### General Information

1. White, red and blue bearings are for sashes weighing up to 22 lbs; green bearings are for sashes weighing up to 26 lbs; yellow bearings are for sashes weighing 26-34 lbs. Consult your sales representative for ordering information.
2. The appropriate tensioning tools are 70-515 and 70-516 as shown on pages 60 and 96.
3. A pre-tensioned balance whose rod length is 1-7/8" longer than the tube is also available on a SPECIAL ORDER, NON-RETURNABLE BASIS. These are generally used by manufacturers' specifications. Consult your sales representative for inquiries or questions. (If you have a pre-tensioned balance and want to use our standard 75 SERIES balance, order 1" longer balance with a standard rod. (e.g. If your pre-tensioned balance is 30" with red bearing, order our 75-S31R.)

#### Extended Rod

Tube Length	Rod Length	White Bearing	Red Bearing	Blue Bearing	Green Bearing*
10"	11-9/16"	75-10	---	---	---
11"	12-9/16"	75-11	---	---	---
12"	13-9/16"	75-12	---	---	---
13"	14-9/16"	75-13	---	---	---
14"	15-9/16"	75-14	---	---	---
15"	16-9/16"	75-15	---	---	---
16"	17-9/16"	75-16	---	---	---
17"	18-9/16"	75-17	75-17R	---	---
18"	19-9/16"	---	---	---	---
19"	18-9/16"	75-19	---	---	---
20"	21-9/16"	---	---	---	---
21"	22-9/16"	75-21	---	---	---
22"	23-9/16"	75-22	---	---	---
23"	24-9/16"	75-23	75-23R	---	---
24"	25-9/16"	75-24	75-24R	---	75-24G
25"	26-9/16"	75-25	75-25R	---	---
26"	27-9/16"	75-26	75-26R	---	---
27"	28-9/16"	75-27	75-27R	---	---
28"	29-9/16"	75-28	75-28R	---	75-28G
29"	30-9/16"	75-29	75-29R	---	---
30"	31-9/16"	75-30	75-30R	---	---
31"	32-9/16"	75-31	75-31R	---	---
32"	33-9/16"	75-32	75-32R	---	---
33"	34-9/16"	75-33	---	---	---
34"	35-9/16"	75-34	---	---	---
35"	36-9/16"	75-35	---	---	---
36"	37-9/16"	75-36	---	---	---
37"	38-9/16"	75-37	---	---	---

\*Other Sizes Available Upon Request.

## 75 SERIES BALANCE ACCESSORIES

### CARRIER BRACKETS

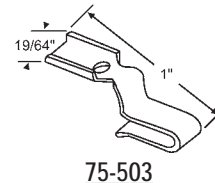
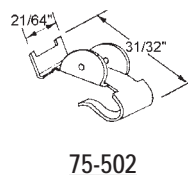
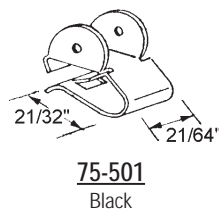
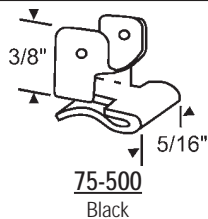

### BALANCE CAP

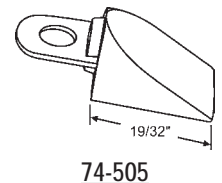

### RIVETS

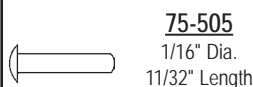
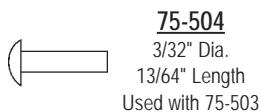

### VENT GUIDE

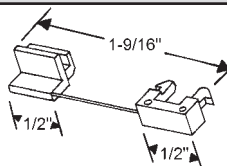

### BALANCE SCREW

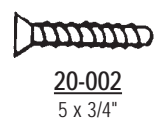

## 76 SERIES BALANCES

### 3/8" TUBE BALANCE

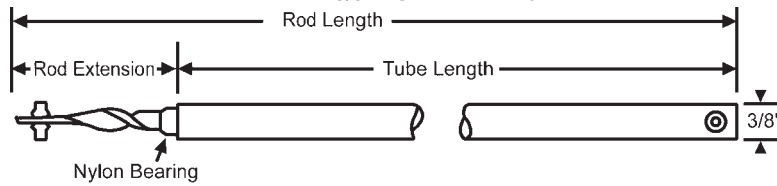

#### Ordering Information

1. Measure metal tube length. (Do not include nylon bearing.)
2. Measure spiral rod length. (Make sure rod is flush with screw hole end of tube before measuring.)
3. Identify the color of the bearing (e.g., white, red, yellow or blue) and select our corresponding part number from the chart below.
4. To identify the appropriate carrier or shoe to be attached and other related accessories, see pages 66-67.

**Note:** Attached carriers and related accessories must be ordered separately. If you want the ends attached, add the letter "A" to the suffix of the part number when ordering.

#### General Information

1. White, red and blue bearings are for sashes weighing up to 22 lbs; green bearings are for sashes weighing up to 26 lbs; yellow-green bearings are for sashes weighing 26-34 lbs. Consult your sales representative for ordering information.
2. The appropriate tensioning tools are 70-515 and 70-516 as shown on pages 60 and 96.

#### Standard Rod

Tube Length	Rod Length	White Bearing	Red Bearing	Blue Bearing	Green* Bearing	Yellow Bearing
10"	10-5/8"	76-SMS10	---	---	---	---
11"	11-5/8"	76-SMS11	---	---	---	---
12"	12-5/8"	76-SMS12	---	---	---	---
13"	13-5/8"	76-SMS13	76-SMS13R	---	---	---
14"	14-5/8"	76-SMS14	76-SMS14R	---	---	---
15"	15-5/8"	76-SMS15	76-SMS15R	76-SMS15B	---	---
16"	16-5/8"	---	76-SMS16R	---	---	---
17"	17-5/8"	---	76-SMS17R	76-SMS17B	---	---
18"	18-5/8"	---	76-SMS18R	76-SMS18B	---	---
19"	19-5/8"	76-SMS19	76-SMS19R	76-SMS19B	76-SMS19G	---
20"	20-5/8"	---	76-SMS20R	76-SMS20B	---	---
21"	21-5/8"	---	76-SMS21R	76-SMS21B	76-SMS21G	---
22"	22-5/8"	76-SMS22	76-SMS22R	76-SMS22B	---	---
23"	23-5/8"	---	76-SMS23R	76-SMS23B	---	76-SMS23Y
24"	24-5/8"	---	76-SMS24R	76-SMS24B	---	---
25"	25-5/8"	---	76-SMS25R	76-SMS25B	---	76-SMS25Y
26"	26-5/8"	76-SMS26	76-SMS26R	---	---	---
27"	27-5/8"	---	76-SMS27R	---	---	---
28"	28-5/8"	---	76-SMS28R	---	76-SMS28G	---
29"	29-5/8"	---	76-SMS29R	---	76-SMS29G	76-SMS29Y
30"	30-5/8"	---	76-SMS30R	---	76-SMS30G	76-SMS30Y
31"	31-5/8"	---	76-SMS31R	---	76-SMS31G	---
32"	32-5/8"	---	76-SMS32R	---	---	---
33"	33-5/8"	76-SMS33	---	---	---	76-SMS33Y
34"	34-5/8"	76-SMS34	---	---	---	---
35"	35-5/8"	76-SMS35	---	---	76-SMS35G	76-SMS35Y
36"	36-5/8"	76-SMS36	---	---	76-SMS36G	76-SMS36Y
37"	37-5/8"	76-SMS37	---	---	---	---
38"	38-5/8"	76-SMS38	---	---	---	76-SMS38Y
39"	39-5/8"	76-SMS39	---	---	---	---
40"	40-5/8"	76-SMS40	---	---	---	76-SMS40Y

#### Extended Rod

Tube Length	Rod Length	White Bearing	Red Bearing	Blue Bearing	Green* Bearing	Yellow Bearing
10"	11-5/8"	76-SM10	---	---	---	---
11"	12-5/8"	76-SM11	---	---	---	---
12"	13-5/8"	76-SM12	---	---	---	---
13"	14-5/8"	76-SM13	76-SM13R	---	---	---
14"	15-5/8"	76-SM14	76-SM14R	---	---	---
15"	16-5/8"	76-SM15	76-SM15R	76-SM15B	---	---
16"	17-5/8"	76-SM16	76-SM16R	76-SM16B	---	---
17"	18-5/8"	76-SM17	76-SM17R	76-SM17B	---	---
18"	19-5/8"	76-SM18	76-SM18R	76-SM18B	---	---
19"	20-5/8"	---	76-SM19R	76-SM19B	---	---
20"	21-5/8"	---	76-SM20R	76-SM20B	---	---
21"	22-5/8"	---	76-SM21R	76-SM21B	---	---
22"	23-5/8"	---	76-SM22R	76-SM22B	---	---
23"	24-5/8"	---	76-SM23R	76-SM23B	---	---
24"	25-5/8"	---	76-SM24R	76-SM24B	---	---
25"	26-5/8"	---	76-SM25R	76-SM25B	---	---
26"	27-5/8"	76-SM26	76-SM26R	---	---	---
27"	28-5/8"	---	76-SM27R	---	---	---
28"	29-5/8"	76-SM28	76-SM28R	---	---	---
29"	30-5/8"	---	76-SM29R	---	---	---
30"	31-5/8"	76-SM30	76-SM30R	---	---	---
31"	32-5/8"	76-SM31	---	---	---	---
32"	33-5/8"	76-SM32	76-SM32R	---	---	---
33"	34-5/8"	76-SM33	---	---	---	---
34"	35-5/8"	76-SM34	---	---	---	---
35"	36-5/8"	76-SM35	---	---	---	---
36"	37-5/8"	76-SM36	---	---	76-SM36G	76-SM36Y
37"	38-5/8"	76-SM37	---	---	---	---
38"	39-5/8"	76-SM38	---	---	---	76-SM38G
39"	40-5/8"	76-SM39	---	---	---	---
40"	41-5/8"	76-SM40	---	---	---	---

\*Other sizes available upon request.

## 76 SERIES BALANCE ACCESSORIES

### HINGE LEAF ASSEMBLY

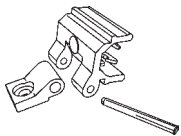

Hinge Assembly w/Metal Bracket

Part #	Color
76-518	White
76-518B	Black

Hinge Assembly - No Metal Bracket

Part #	Color
76-523	White
76-523B	Black

**SILVERLINE**

### INSTALLATION KIT

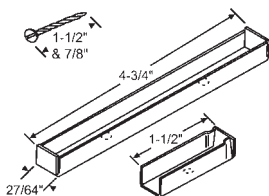

#### 70-708

For stop/balance bracket installation. Contains brackets, assorted screws and nails; enough for 1 window.

#### 76-500

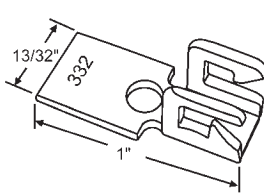

### METAL SASH CLIPS

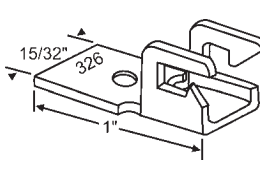

#### 76-501

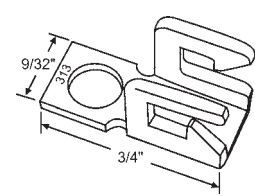

#### 76-502

**KINRO/SILVERLINE**

## 76 SERIES BALANCE ACCESSORIES

### METAL SASH CLIPS

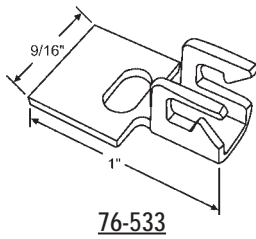

**76-533**

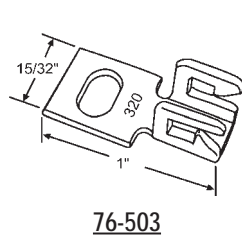

**76-503**

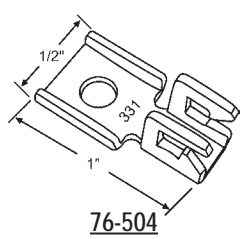

**76-504**

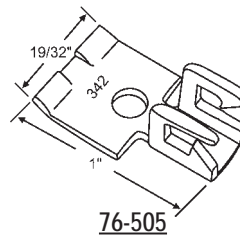

**76-505**

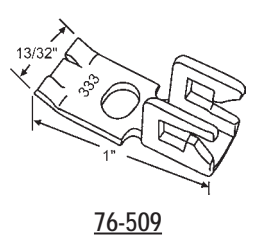

**76-509**

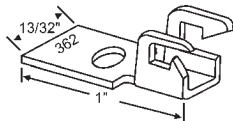

**76-510**

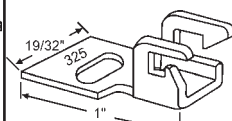

**76-511**

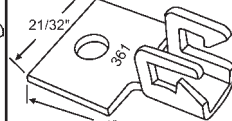

**76-513**

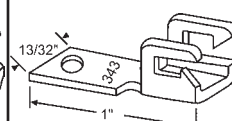

**76-514**

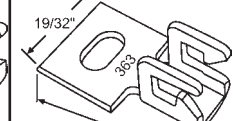

**76-515**

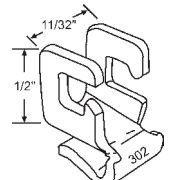

**76-516**

Clip On

**GENERAL ALUMINUM**

### CARRIER

### BALANCE CAP

### TOP SASH GUIDES

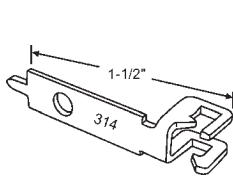

**76-506**

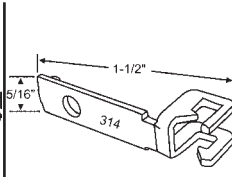

**76-507**

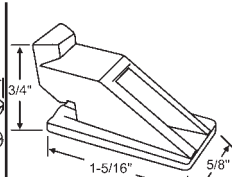

**76-517**

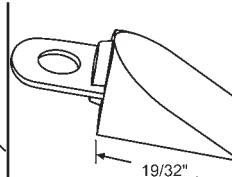

**74-505**

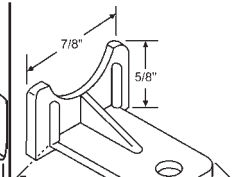

**900-5013**  
Natural Nylon

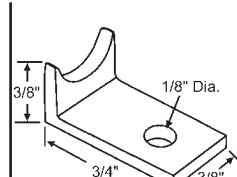

**900-6861**  
Nylon

### SNAP-IN SASH GUIDES

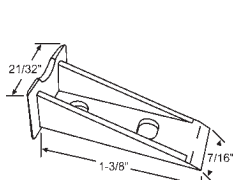

**76-603**

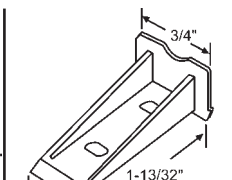

**76-604**  
New Style. (Old Style only had 1 mounting hole.)

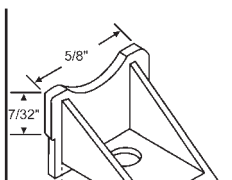

**900-5522**  
**CROWN**

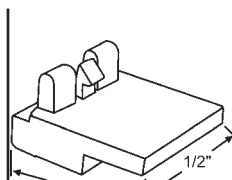

**76-602**  
Natural  
**KELLER**

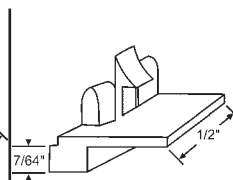

Part #	Color
76-607	Black
76-607W	White

**HARCAR**

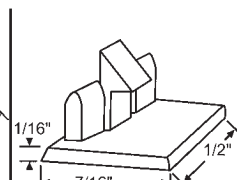

**900-9966**  
Natural  
**HARCAR**

### FACE GUIDES

### SPRING GUIDES

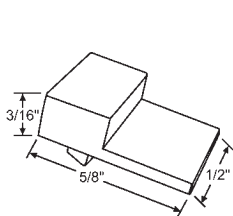

**HWP956 WH**  
White  
**PGT**

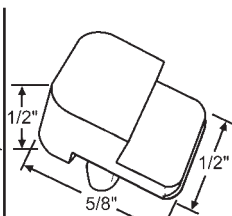

**HWP959 WH**  
White  
**PGT**

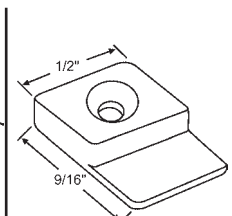

**76-600**  
Uses 20-004 Screw

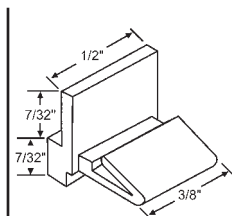

Part #	Color
76-608	Black
76-608W	White

**HARCAR**

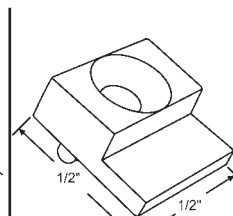

**76-611**  
Black  
**KELLER**

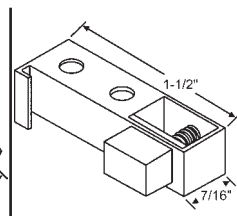

Part #	Hand
76-610RH	Shown
76-610LH	Opposite

**RUSCO**

## 78A SERIES BALANCES

### 3/8" PLASTIC TUBE BALANCE

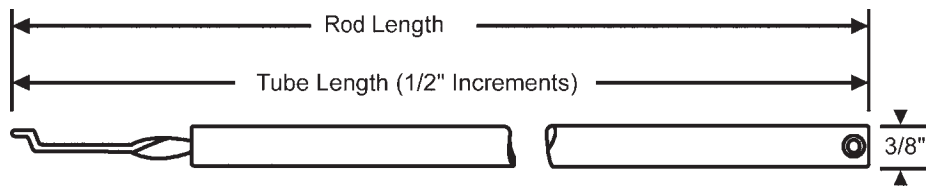

Tube Length	Part Number
14"	78A-14
15"	78A-15
16"	78A-16
16-1/2"	78A-16.5
17"	78A-17
17-1/2"	78A-17.5
18"	78A-18
18-1/2"	78A-18.5
19"	78A-19
19-1/2"	78A-19.5
20"	78A-20
20-1/2"	78A-20.5
21"	78A-21
21-1/2"	78A-21.5
22"	78A-22
22-1/2"	78A-22.5
23"	78A-23
23-1/2"	78A-23.5
24"	78A-24
24-1/2"	78A-24.5
25"	78A-25
25-1/2"	78A-25.5

Tube Length	Part Number
26"	78A-26
26-1/2"	78A-26.5
27"	78A-27
27-1/2"	78A-27.5
28"	78A-28
28-1/2"	78A-28.5
29"	78A-29
29-1/2"	78A-29.5
30"	78A-30
30-1/2"	78A-30.5
31"	78A-31
31-1/2"	78A-31.5
32"	78A-32
32-1/2"	78A-32.5
33"	78A-33
33-1/2"	78A-33.5
34"	78A-34
34-1/2"	78A-34.5
35"	78A-35
35-1/2"	78A-35.5
36"	78A-36

#### Ordering Information

1. Measure length of the plastic tube.
2. Select corresponding part number from the chart below.
3. To identify any attaching brackets or accessories used with your balance refer to bottom of the page.

Note: Accessories must be ordered separately.

#### General Information

1. Gray tubes are standard stock items, all other colors must be special order.

## 78A SERIES BALANCE ACCESSORIES

### BRACKET

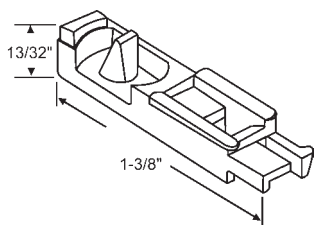

**78-508**

### METAL SASH CLIP

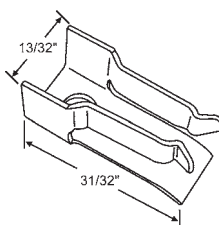

**78-600**

### TOP SASH GUIDE

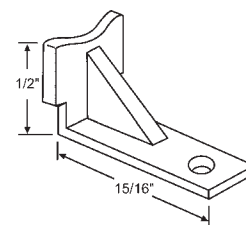

**78-602**

### RETAINER LATCH

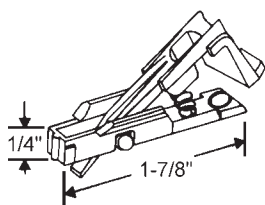

**78-603**

### SASH CLIPS

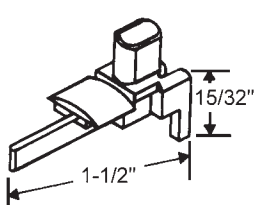

**78-604**

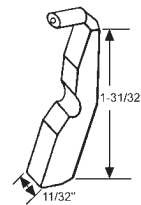

**78-605**

## 80 SERIES BALANCES

### 5/8" PLASTIC TUBE BALANCE

Tube diameter 9/16" but considered 5/8" in the trade.

NOTE: In most cases, the 72 series balances can be used as a direct substitute. Consult your account representative.

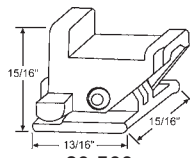

**80-500**

Order Separately.  
If Needed Attached, Add Suffix A

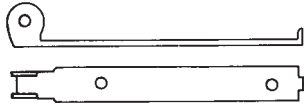

**70-523**

Comes Attached to Balance

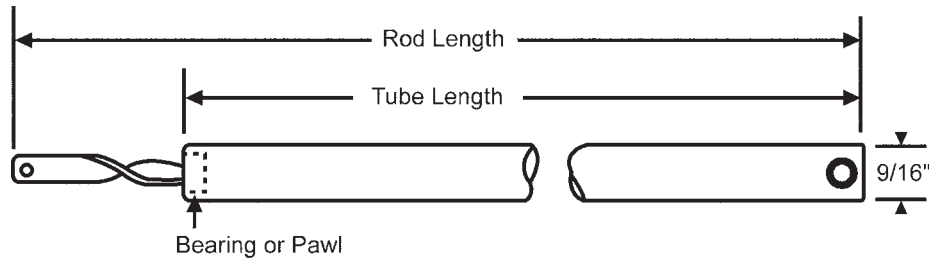

**83-502**  
Lock Screw

#### General Information

- In the past, various bearing (or pawl) colors were used to indicate different weight ranges for these balances. The colors used were white, red, blue, black and yellow. Currently the standard color for sashes weighing up to 30 lbs. is red and for 30 to 40 lbs, sash is yellow. If your sash weighs between 30 and up to 40 lbs., please specify HD after the part number.
- Gray tubes are standard. All other colors must be special order.

#### Ordering Information

- Measure length of the plastic tube.
- Select corresponding part number from the chart.
- Identify which carrier or shoe to be attached as well as accessories needed with your balance.

**Note:** 80-500 must be ordered separately. If you want the end attached, add the letter "A" to the suffix of the part number of the attached when ordering.

#### Ordering Example

If ordering a 22" extended rod balance with an 80-500 foot attached and your sash weighs 30 to 40 lbs., your part # is 80-22P-1HD for the balance and 80-500A for the foot attached.

#### When 80-500 is Attached

Rod length is 1-3/4" longer than tube.

Tube Length	Part Number
16"	80-16P-1
18"	80-18P-1
20"	80-20P-1
22"	80-22P-1
23"	80-23P-1
24"	80-24P-1
25"	80-25P-1
26"	80-26P-1
27"	80-27P-1
28"	80-28P-1
29"	80-29P-1
30"	80-30P-1
32"	80-32P-1
34"	80-34P-1
36"	80-36P-1

#### When 70-523 is Attached

Rod length is 3/4" longer than tube.

Tube Length	Part Number
16"	80-S16P-1
18"	80-S18P-1
20"	80-S20P-1
22"	80-S22P-1
23"	80-S23P-1
24"	80-S24P-1
25"	80-S25P-1
26"	80-S26P-1
27"	80-S27P-1
28"	80-S28P-1
29"	80-S29P-1
30"	80-S30P-1
32"	80-S32P-1
34"	80-S34P-1
36"	80-S36P-1

## 80 SERIES BALANCE ACCESSORIES

### FOOT ATTACHMENT

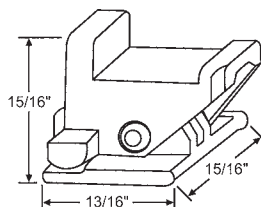

Part #	Description
80-500	No Rivet
80-500R	Includes Rivet

### BRACKETS

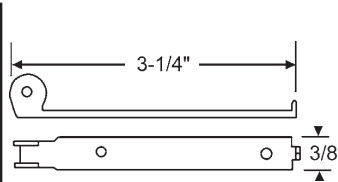

**70-523**  
Uses Rivet 74-509

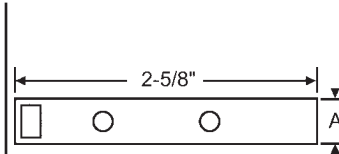

Part #	"A"
900-9939	3/8"

### BALANCE SCREW

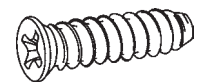

**20-001**  
10 x 3/4", Phillips Head

### RIVET

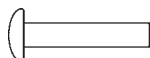

**80-501**  
1/8" Diameter, 1/2" Length  
Used With: 80-500

### SASH CLIPS

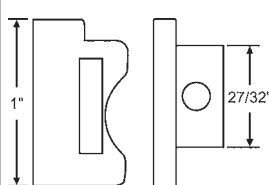

**80-600A**  
Sash Guide Set, LH and RH

### LOWER SASH BLOCK

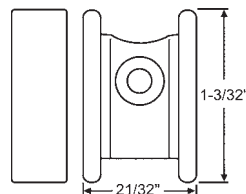

**80-602**

### FRAME RETAINER

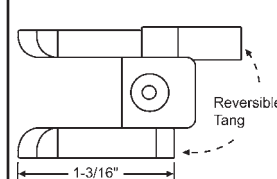

**80-700**  
Nylon

### TOP SASH GUIDE

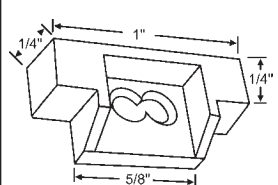

**900-21614**  
**ANDERSON**

## 80A SERIES BALANCES

### 5/8" PLASTIC TUBE BALANCE

Tube diameter 9/16" but considered 5/8" in the trade.

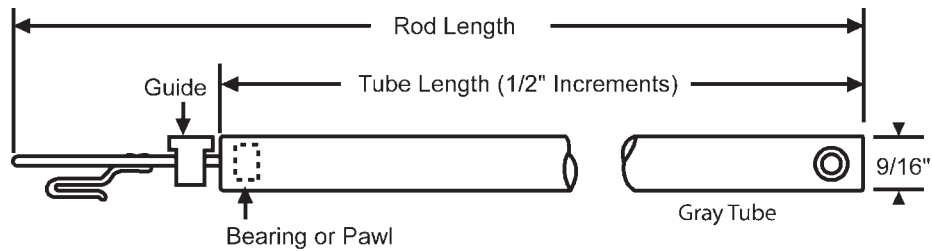

Tube Length	Part Number
15"	80A-15
15-1/2"	80A-15.5
16"	80A-16
16-1/2"	80A-16.5
17"	80A-17
17-1/2"	80A-17.5
18"	80A-18
18-1/2"	80A-18.5
19"	80A-19
19-1/2"	80A-19.5
20"	80A-20
20-1/2"	80A-20.5
21"	80A-21
21-1/2"	80A-21.5
22"	80A-22
22-1/2"	80A-22.5
23"	80A-23
23-1/2"	80A-23.5
24"	80A-24
24-1/2"	80A-24.5
25"	80A-25

Tube Length	Part Number
25-1/2"	80A-25.5
26"	80A-26
26-1/2"	80A-26.5
27"	80A-27
27-1/2"	80A-27.5
28"	80A-28
28-1/2"	80A-28.5
29"	80A-29
29-1/2"	80A-29.5
30"	80A-30
30-1/2"	80A-30.5
31"	80A-31
31-1/2"	80A-31.5
32"	80A-32
32-1/2"	80A-32.5
33"	80A-33
33-1/2"	80A-33.5
34"	80A-34
34-1/2"	80A-34.5
35"	80A-35
35-1/2"	80A-35.5

#### Ordering Information

1. Measure length of the plastic tube.
2. Select corresponding part number from the chart at left.
3. Balance brackets must be ordered separately. See below.

#### General Information

1. In the past, various bearing (or pawl) colors were used to indicate different weight ranges for these balances. The colors used were white, red, blue, black and yellow. Currently the standard color for sashes weighing up to 30 lbs. is red and for 30 to 40 lbs. sash is yellow. If your sash weighs between 30 and 40 lbs., please specify HD after the part number. Example: If ordering a 25-1/2" balance and your sash weighs 30 to 40 lbs., your part # is 80A-25.5HD.
2. This style balance is also available in 3/8". See 78C Series.
3. Tube length is available in 1/2" increments.
4. Gray tubes are standard; other colors available. Please consult your sales representative.
5. Used primarily in Northeast—New Jersey and New York.

## 80A SERIES BALANCE ACCESSORIES

#### GUIDE

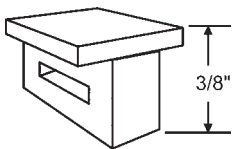

**80-605**

#### BRACKET

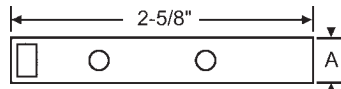

Part #	"A"
900-9939	3/8"

#### BALANCE SCREW

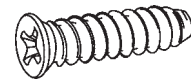

**20-001**  
10 x 3/4", Phillips Head

## BALANCE BRACKETS

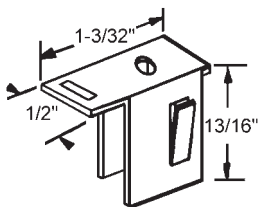

**900-16911**

Must Be Purchased Separately

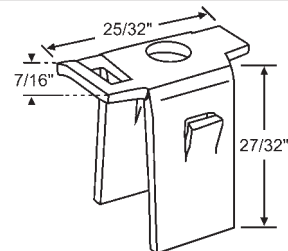

**80-502**

Must Be Purchased Separately



## 80B SERIES BALANCES

### 5/8" PLASTIC TUBE BALANCE

Tube diameter 9/16" but considered 5/8" in the trade.

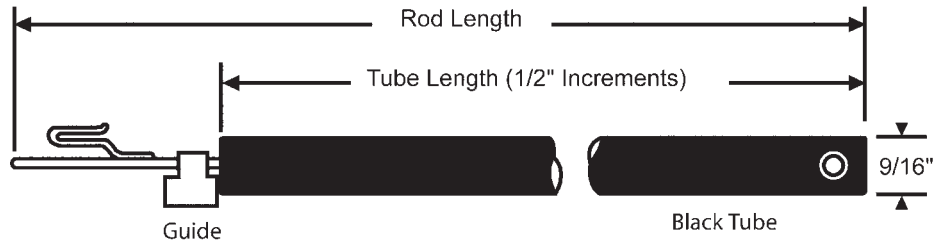

Tube Length	Part Number
15"	80B-15
15-1/2"	80B-15.5
16"	80B-16
16-1/2"	80B-16.5
17"	80B-17
17-1/2"	80B-17.5
18"	80B-18
18-1/2"	80B-18.5
19"	80B-19
19-1/2"	80B-19.5
20"	80B-20
20-1/2"	80B-20.5
21"	80B-21
21-1/2"	80B-21.5
22"	80B-22
22-1/2"	80B-22.5
23"	80B-23
23-1/2"	80B-23.5
24"	80B-24
24-1/2"	80B-24.5
25"	80B-25

Tube Length	Part Number
25-1/2"	80B-25.5
26"	80B-26
26-1/2"	80B-26.5
27"	80B-27
27-1/2"	80B-27.5
28"	80B-28
28-1/2"	80B-28.5
29"	80B-29
29-1/2"	80B-29.5
30"	80B-30
30-1/2"	80B-30.5
31"	80B-31
31-1/2"	80B-31.5
32"	80B-32
32-1/2"	80B-32.5
33"	80B-33
33-1/2"	80B-33.5
34"	80B-34
34-1/2"	80B-34.5
35"	80B-35
35-1/2"	80B-35.5
36"	80B-36

### Ordering Information

1. Measure length of the plastic tube.
2. Select corresponding part number from the chart at left.
3. Balance brackets must be ordered separately.

### General Information

1. In the past, various bearing (or pawl) colors were used to indicate different weight ranges for these balances. The colors used were white, red, blue, black and yellow. Currently the standard color for sashes weighing up to 30 lbs. is red and for 30 to 40 lbs. sash is yellow. If your sash weighs between 30 and 40 lbs., please specify HD after the part number. Example: If ordering a 25-1/2" balance and your sash weighs 30 to 40 lbs., your part # is 80B-25.5HD.
2. This style balance is also available in 3/8". Please consult your sales representative.
3. Tube length is available in 1/2" increments.
4. Black tubes are standard; other colors available. Please consult your sales representative.

## 80B SERIES BALANCE ACCESSORIES

### GUIDE

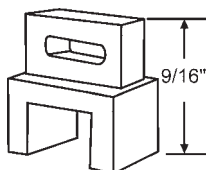

**80-603**  
Not Sold Separately

### BRACKET

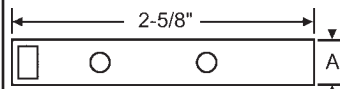

Part #	"A"
900-9939	3/8"

### BALANCE BRACKET

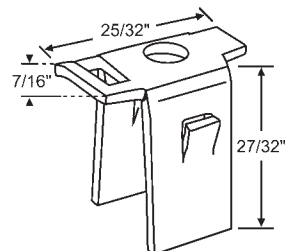

**80-502**  
Must be purchased separately.

### BALANCE SCREW

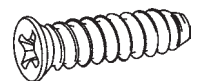

**20-001**  
10 x 3/4", Phillips Head

### 5/8" PLASTIC TUBE BALANCE

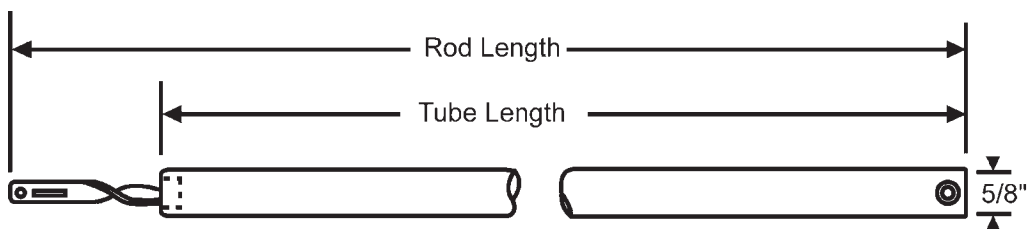

#### Ordering Information

1. Measure length of the plastic tube.
2. Select corresponding part number from the chart below and order accordingly.

#### General Information

1. Gray tubes are standard. All other colors must be special ordered.

#### 5/8" Tubes 80SL Series

Tube Length	Part Number	Tube Length	Part Number
15"	80SL-15	25-1/2"	80SL-25.5
15-1/2"	80SL-15.5	26"	80SL-26
16"	80SL-16	26-1/2"	80SL-26.5
16-1/2"	80SL-16.5	27"	80SL-27
17"	80SL-17	27-1/2"	80SL-27.5
17-1/2"	80SL-17.5	28"	80SL-28
18"	80SL-18	28-1/2"	80SL-28.5
18-1/2"	80SL-18.5	29"	80SL-29
19"	80SL-19	29-1/2"	80SL-29.5
19-1/2"	80SL-19.5	30"	80SL-30
20"	80SL-20	30-1/2"	80SL-30.5
20-1/2"	80SL-20.5	31"	80SL-31
21"	80SL-21	31-1/2"	80SL-31.5
21-1/2"	80SL-21.5	32"	80SL-32
22"	80SL-22	32-1/2"	80SL-32.5
22-1/2"	80SL-22.5	33"	80SL-33
23"	80SL-23	33-1/2"	80SL-33.5
23-1/2"	80SL-23.5	34"	80SL-34
24"	80SL-24	34-1/2"	80SL-34.5
24-1/2"	80SL-24.5	35"	80SL-35
25"	80SL-25	35-1/2"	80SL-35.5

## 83 SERIES BALANCES

### 3/8" TILT TUBE BALANCE

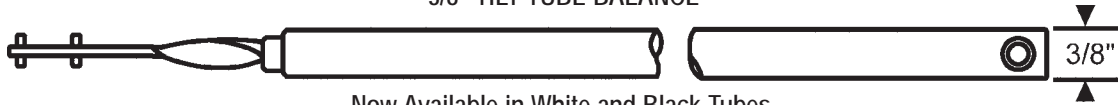

Now Available in White and Black Tubes.

#### Ordering Information

1. Measure metal tube length. (Do not include nylon bearing.)
2. Identify color of bearing (e.g. white or red) and select corresponding part number from the chart below.
3. When ordering a black or white tube, add a B (black) or W (white) at the end of the part number

#### General Information

Appropriate tensioning tools are 85-511 and 85-515 as shown on pages 87 and 96.

Tube Length	Bearing Color	Part#	Weight Range
10	white	83-10W	4 thru 13
10	red	83-10R	8 thru 17
10	blue	83-10B	11 thru 20
11	white	83-11W	4 thru 13
11	red	83-11R	7 thru 17
11	blue	83-11B	11 thru 20
11	green	83-11G	14 thru 20
12	white	83-12W	4 thru 13
12	red	83-12R	7 thru 17
12	blue	83-12B	11 thru 20
12	green	83-12G	14 thru 20
13	white	83-13W	4 thru 13
13	red	83-13R	7 thru 17
13	blue	83-13B	11 thru 20
13	green	83-13G	14 thru 22
14	white	83-14W	4 thru 13
14	red	83-14R	6 thru 17
14	blue	83-14B	9 thru 21
14	green	83-14G	14 thru 24
15	white	83-15W	4 thru 13
15	red	83-15R	6 thru 17
15	blue	83-15B	9 thru 21
15	green	83-15G	14 thru 24
16	red	83-16R	6 thru 17
16	blue	83-16B	9 thru 21
16	green	83-16G	14 thru 24
17	red	83-17R	6 thru 17
17	blue	83-17B	9 thru 21
17	green	83-17G	14 thru 24
17	yellow	83-17Y	24 thru 34
18	red	83-18R	6 thru 16
18	blue	83-18B	9 thru 21
18	green	83-18G	14 thru 24
18	yellow	83-18Y	24 thru 34
19	red	83-19R	6 thru 16
19	blue	83-19B	9 thru 21
19	green	83-19G	14 thru 26

Tube Length	Bearing Color	Part#	Weight Range
19	yellow	83-19Y	24 thru 34
20	red	83-20R	8 thru 21
20	blue	83-20B	12 thru 22
20	green	83-20G	14 thru 26
20	yellow	83-20Y	24 thru 34
21	white	83-21W	6 thru 15
21	red	83-21R	8 thru 21
21	blue	83-21B	12 thru 22
21	green	83-21G	14 thru 26
21	yellow	83-21Y	24 thru 34
22	red	83-22R	8 thru 21
22	blue	83-22B	12 thru 22
22	green	83-22G	14 thru 26
22	yellow	83-22Y	24 thru 34
23	red	83-23R	7 thru 21
23	blue	83-23B	12 thru 22
23	green	83-23G	14 thru 26
23	yellow	83-23Y	24 thru 34
24	red	83-24R	7 thru 21
24	blue	83-24B	11 thru 22
24	green	83-24G	14 thru 26
24	yellow	83-24Y	24 thru 34
25	white	83-25W	6 thru 14
25	red	83-25R	7 thru 21
25	blue	83-25B	11 thru 22
25	green	83-25G	14 thru 26
25	yellow	83-25Y	24 thru 34
26	red	83-26R	10 thru 22
26	green	83-26G	14 thru 26
26	yellow	83-26Y	24 thru 34
27	red	83-27R	10 thru 22
27	green	83-27G	14 thru 26
27	yellow	83-27Y	24 thru 34

Tube Length	Bearing Color	Part#	Weight Range
28	red	83-28R	10 thru 22
28	green	83-28G	14 thru 26
28	yellow	83-28Y	24 thru 34
29	red	83-29R	10 thru 22
29	green	83-29G	14 thru 26
29	yellow	83-29Y	24 thru 34
30	red	83-30R	10 thru 22
30	green	83-30G	14 thru 26
30	yellow	83-30Y	24 thru 34
31	white	83-31W	5 thru 21
31	red	83-31R	10 thru 22
31	green	83-31G	14 thru 26
31	yellow	83-31Y	24 thru 34
32	red	83-32R	10 thru 22
32	green	83-32G	14 thru 26
32	yellow	83-32Y	24 thru 34
33	white	83-33W	7 thru 22
33	green	83-33G	14 thru 26
33	yellow	83-33Y	24 thru 34
34	white	83-34W	7 thru 22
34	green	83-34G	14 thru 26
34	yellow	83-34Y	24 thru 34
35	white	83-35W	7 thru 22
35	green	83-35G	14 thru 26
35	yellow	83-35Y	24 thru 34
36	white	83-36W	7 thru 22
36	green	83-36G	14 thru 26
36	yellow	83-36Y	24 thru 34
37	white	83-37W	7 thru 22
37	green	83-37G	14 thru 26
37	yellow	83-37Y	24 thru 34
38	white	83-38W	7 thru 22
38	green	83-38G	14 thru 26
38	yellow	83-38Y	24 thru 34
39	white	83-39W	7 thru 22
39	green	83-39G	14 thru 26
39	yellow	83-39Y	24 thru 34

## 83 SERIES BALANCE ACCESSORIES

### PIVOT LOCK SHOES

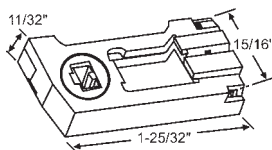

#### 83-500

Black Cam. Opening: 1/4" x 3/16"  
Used with Pivot Bar 83-504

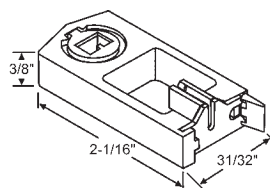

#### 83-507

Red Cam  
Opening: 1/4" x 3/16"

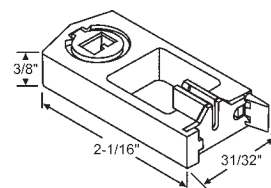

#### 83-508

White Cam  
Opening: 1/4" x 3/16"

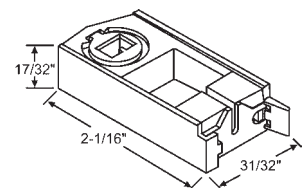

#### 83-509

Royal Blue Cam  
Opening: 1/4" x 3/16"

# SASH SUPPORT SYSTEMS

## 83 SERIES BALANCE ACCESSORIES

### PIVOT LOCK SHOES

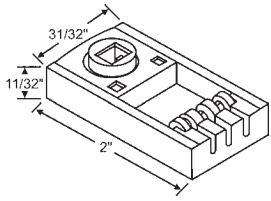

**83-510**  
Opening: 9/32" x 7/32"

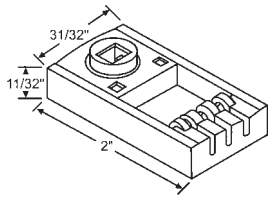

**83-512**  
Cam Opening: 21/64" x 7/32"

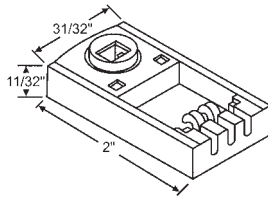

**83-513**  
Cam Opening: 21/64" x 21/32"

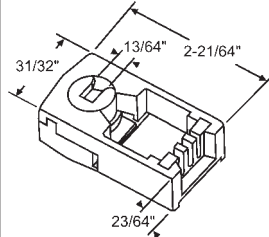

**83-514**  
Blue Cam  
**CAREFREE**

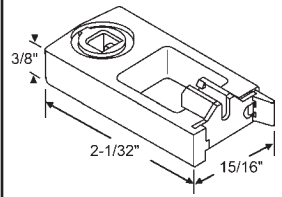

**83-533**  
Black Cam  
Opening: 5/16" x 3/16"

### SPLIT ROLL PIN

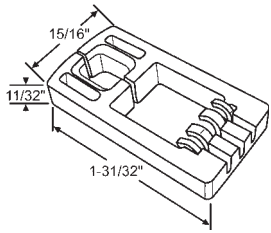

**83-528**  
White

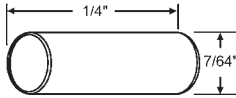

**83-503**

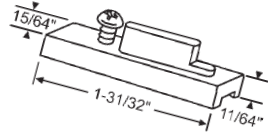

**83-504**  
Die Cast, with Screw

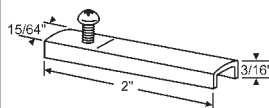

**83-628**  
Steel Stamping. Includes Screw

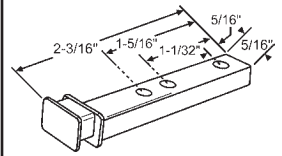

**83-517**  
Pivot Bar

### PIVOT BAR HOLDER

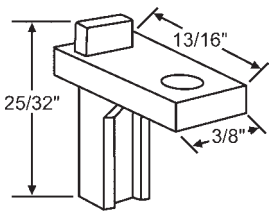

**83-535**  
Pivot Bar

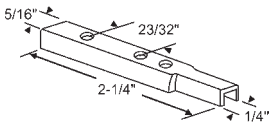

**85-557**  
Stamped. Use with 83-506  
Pivot Lock Shoe.  
**ROLLYSON**

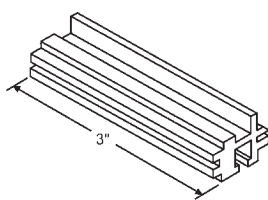

**900-11662**  
White  
**REYNOLDS**

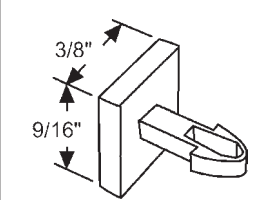

**83-525**  
Plastic

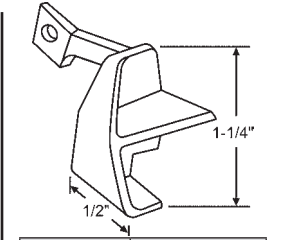

Part #	Hand
83-605	Shown
83-606	Opposite

Black  
**SECURITY**

### SLIDE/TILT LATCHES

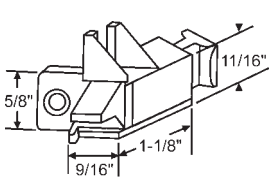
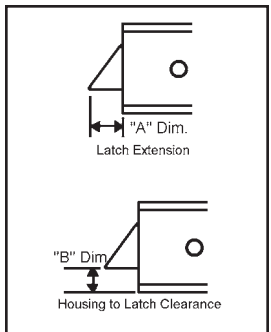

Part #	Color
83-614BA	Black

"A"	"B"
3/8"	1/4"

Sold in sets only (RH/LH).  
**REYNOLDS**

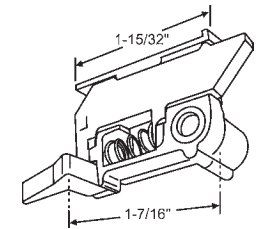

Part #	Color
83-603BA	Black

Sold in sets only. RH Shown  
Black with Stop  
**ACORN**

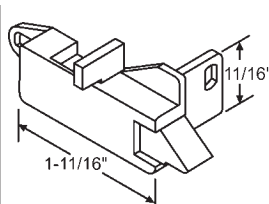

Part #	Color
83-625BA	Black

"A"	"B"
5/16"	1/8"

Sold in sets only (RH/LH).  
**ACORN**

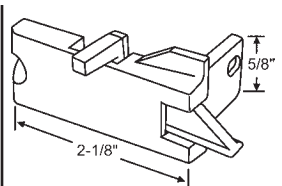

Part #	Color
83-624WA	White
83-624BA	Black

"A"	"B"
3/8"	7/32"

Sold in sets only. Top and Side Mounted.  
**BETTER-BILT**

## 83 SERIES BALANCE ACCESSORIES

### SLIDE/TILT LATCHES

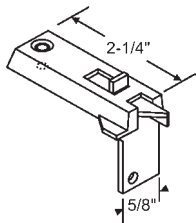

Part #	Color
83-620WA	White

"A"	"B"
3/8"	1/4"

Sold in Sets Only. LH Shown  
**BETTER-BILT**

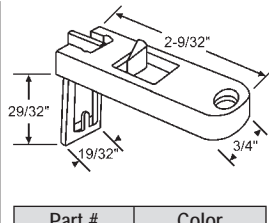

Part #	Color
83-607BA	Black
83-607WA	White

"A"	"B"
3/8"	1/4"

Sold in sets only. Top and Side Mounted.  
**KELLER**

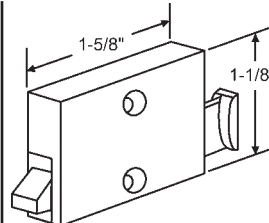

Part #	Color
900-10278	Black

"A"	"B"
1/4"	1/4"

Reversible  
**REYNOLDS**

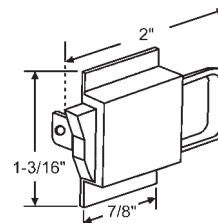

Part #	Color
83-613	Black

"A"	"B"
3/8"	1/4"

Reversible. Side Mounted  
**ALUM. INDUSTRIES**

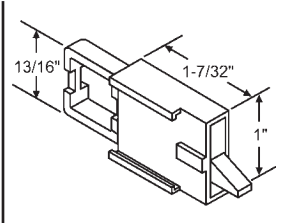

Part #	Hand	Color
83-617LH	Shown	Black
83-617RH	Opposite	Black

"A"	"B"
11/32"	5/16"

Slides onto extrusion.

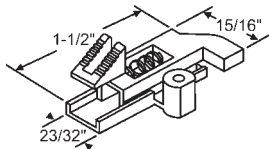

Part #	Color
83-522	Black

"A"	"B"
19/64"	3/8"

Slides onto extrusion. Black

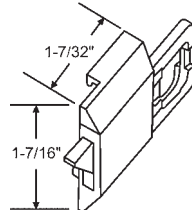

Part #	Color
83-600BA	Black
83-600WA	White

"A"	"B"
9/32"	3/8"

**KELLER**

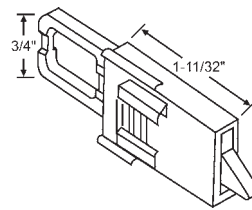

Part #	Color
83-627BA	Black

"A"	"B"
3/8"	1/4"

Sold in sets only. Slides onto extrusion.

**BETTER-BILT**

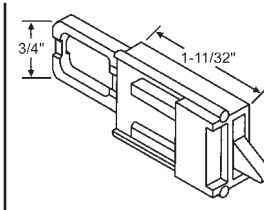

Part #	Color
83-623BA	Black

"A"	"B"
11/32"	1/4"

Sold in sets only. Slides onto extrusion.

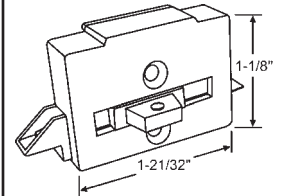

**83-602**  
Black  
**ACORN**

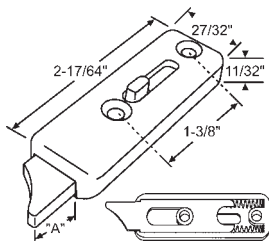

Part #	Color
83-704WA	White

"A"	"B"
19/32"	5/32"

Sold in Sets Only

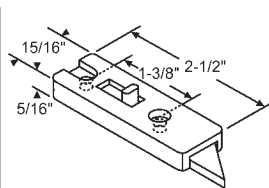

Part #	Color
83-523BA	Black
83-523WA	White

"A"	"B"
1/2"	1/4"

Sold in Sets Only

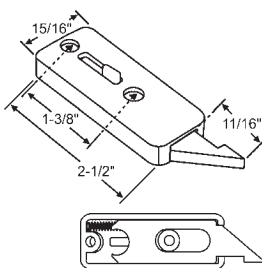

Part #	Color
83-631	Black
83-631W	White

Sold as Set Only  
LH Shown

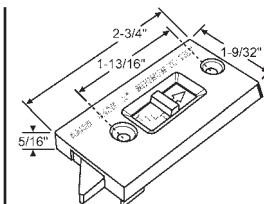

Part #	Hand	Color
83-526LB	Shown	Black
83-526RB	Opposite	Black
83-526LW	Shown	White
83-526RW	Opposite	White

"A"	"B"
3/8"	5/16"

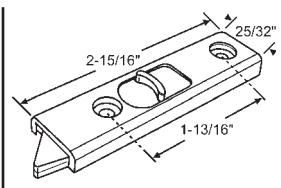

Part #	Hand	Color
83-635LHB	Shown	Black
83-635RHB	Opposite	Black
83-635LHW	Shown	White
83-635RHW	Opposite	White

"A"	"B"
11/32"	1/8"

**ALENCO**

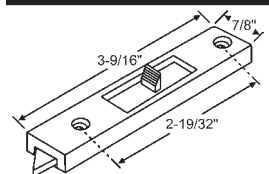

Part #	Hand	Color
83-622LHW	Shown	White
83-622RHW	Opposite	White
83-622LBG	Shown	Beige
83-622RBG	Opposite	Beige
83-622LHB	Shown	Black
83-622RHB	Opposite	Black

"A"	"B"
3/8"	3/16"

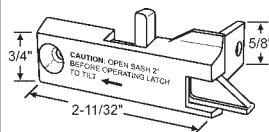

Part #	Color
83-621WA	White
83-621BA	Black

"A"	"B"
3/8"	1/8"

Sold in Sets Only

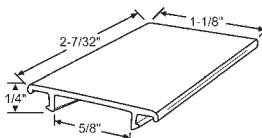

**83-641WX**  
White Vinyl

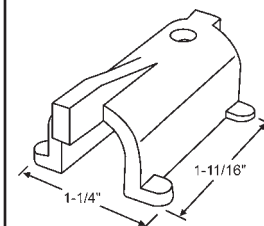

**83-700**  
Black  
**ACORN**

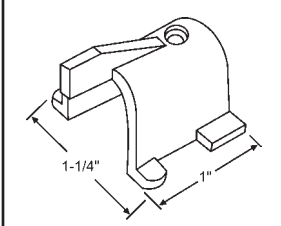

Part #	Finish
900-9712	Black
900-9712W	White

**ACORN**

### SASH STOPS

### 3/8" Tilt Tube Balance

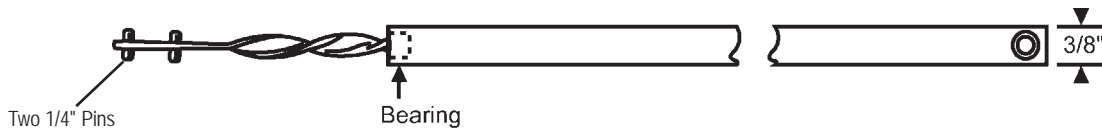

#### Ordering Information

1. Measure plastic tube length.
2. Identify bearing color by looking down into the tube where the rod comes out. Refer to general information #1.
3. Select the part number from the chart below for (2) 1/4" pin configuration.
4. If different configuration, select appropriate pin configuration from the chart and add the number to the end of the part number.

#### Example Ordering Chart

Balance Length	Tube Color	Pin Configuration	Complete Part Number
26"	White	-	83-P26W
19"	Black	2	83-P19B-2

#### General Information

1. The bearing (or Pawl) colors used on the 83P Series balance are white for sash weighing up to 18 lbs., and yellow for sash weighing 18 to 30 lbs. If your sash weighs between 18 and 30lbs, add HD after the part number. Example: If ordering a 36" balance for a 23 lb. sash, your part number is 83-P36HD.
2. Standard tube color is gray. If ordering white, place the letter "W" at the end of the part number. If ordering black, place the letter "B" at the end of the part number.
3. Appropriate tensioning tools are 85-511 and 85-515 as shown on pages 87 and 96.
4. Accessories must be ordered separately.

Tube Length	Tube Color	Part Number
15"	Gray	83-P15
16"	Gray	83-P16
17"	Gray	83-P17
18"	Gray	83-P18
19"	Gray	83-P19
20"	Gray	83-P20
21"	Gray	83-P21
22"	Gray	83-P22
23"	Gray	83-P23
24"	Gray	83-P24
25"	Gray	83-P25
26"	Gray	83-P26
27"	Gray	83-P27
28"	Gray	83-P28
29"	Gray	83-P29
30"	Gray	83-P30
31"	Gray	83-P31
32"	Gray	83-P32
33"	Gray	83-P33
34"	Gray	83-P34
35"	Gray	83-P35
36"	Gray	83-P36
37"	Gray	83-P37
38"	Gray	83-P38
39"	Gray	83-P39
40"	Gray	83-P40
41"	Gray	83-P41
42"	Gray	83-P42
43"	Gray	83-P43
44"	Gray	83-P44
45"	Gray	83-P45

#### Balance Pin Options

-1  
One 3/4" Pin



-2  
Two 3/4" Pins



-3  
One 1/2" Pin



-4  
Two 1/2" Pins

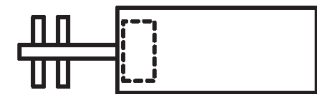

-5  
One 1/4" Pin

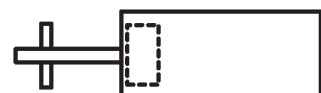

\*Other sizes available upon request.

## 84 SERIES 5/8" PNEU-LIFT TILT ASSEMBLY

All balances are same length - Only gas pressures differ.  
Will not work for the old style 3/4" balance

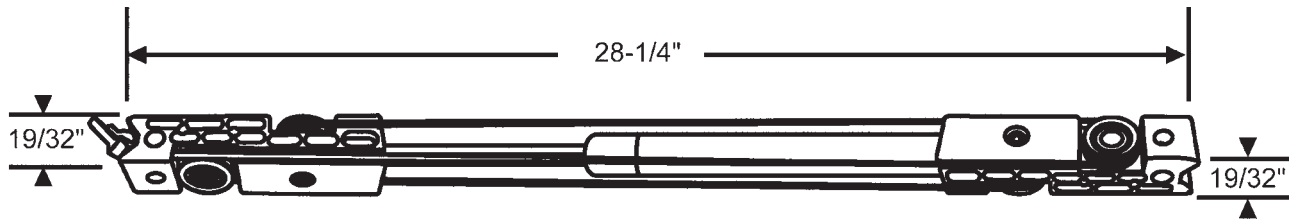

Part Number	Suggested Weight Per Pair	Suggested Weight 4 Per Sash	
84-35-1	18 to 21 lbs.	36 to 42 lbs.	w/60-518 attached
84-35-5	18 to 21 lbs.	36 to 42 lbs.	w/900-18354 attached
84-40-1	21 to 24 lbs.	42 to 48 lbs.	w/60-518 attached
84-40-5	21 to 24 lbs.	42 to 48 lbs.	w/900-18354 attached
84-45-1	24 to 27 lbs.	48 to 54 lbs.	w/60-518 attached
84-45-5	24 to 27 lbs.	48 to 54 lbs.	w/900-18354 attached
84-50-1	27 to 30 lbs.	54 to 60 lbs.	w/60-518 attached
84-50-5	27 to 30 lbs.	54 to 60 lbs.	w/900-18354 attached
84-55-1	30 to 32 lbs.	60 to 64 lbs.	w/60-518 attached
84-55-5	30 to 32 lbs.	60 to 64 lbs.	w/900-18354 attached
84-60-1	32 to 36 lbs.	64 to 72 lbs.	w/60-518 attached
84-60-5	32 to 36 lbs.	64 to 72 lbs.	w/900-18354 attached
84-65-1	36 to 39 lbs.	72 to 78 lbs.	w/60-518 attached
84-65-5	36 to 39 lbs.	72 to 78 lbs.	w/900-18354 attached
84-70-1	39 to 43 lbs.	78 to 86 lbs.	w/60-518 attached
84-70-5	39 to 43 lbs.	78 to 86 lbs.	w/900-18354 attached
84-75-1	43 to 45 lbs.	86 to 90 lbs.	w/60-518 attached
84-75-5	43 to 45 lbs.	86 to 90 lbs.	w/900-18354 attached
84-80-1	45 to 48 lbs.	90 to 96 lbs.	w/60-518 attached
84-80-5	45 to 48 lbs.	90 to 96 lbs.	w/900-18354 attached
84-85-1	48 to 52 lbs.	96 to 104 lbs.	w/60-518 attached
84-85-5	48 to 52 lbs.	96 to 104 lbs.	w/900-18354 attached
84-90-1	52 to 55 lbs.	104 to 110 lbs.	w/60-518 attached
84-90-5	52 to 55 lbs.	104 to 110 lbs.	w/900-18354 attached
84-95-1	55 to 58 lbs.	110 to 116 lbs.	w/60-518 attached
84-95-5	55 to 58 lbs.	110 to 116 lbs.	w/900-18354 attached
84-105-1	58 to 62 lbs.	116 to 124 lbs.	w/60-518 attached
84-105-5	58 to 62 lbs.	116 to 124 lbs.	w/900-18354 attached
84-110-1	62 to 64 lbs.	124 to 129 lbs.	w/60-518 attached
84-110-5	62 to 64 lbs.	124 to 129 lbs.	w/900-18354 attached

### OPTIONAL END BRACKETS

**-5**

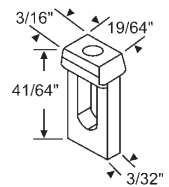

#### 900-18354

If ordering with our optional 900-18354 clip attached, Please add ".5" after the part number

**-1**

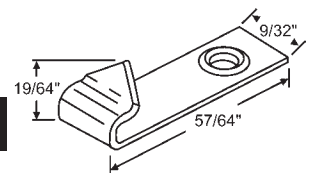

#### 60-518

If ordering with our optional 60-518 clip attached, Please add "-1" after the part number

**Contact Account Manager For Pricing**

# SASH SUPPORT SYSTEMS

## 84S SERIES SHORT 5/8" PNEU-LIFT TILT ASSEMBLY

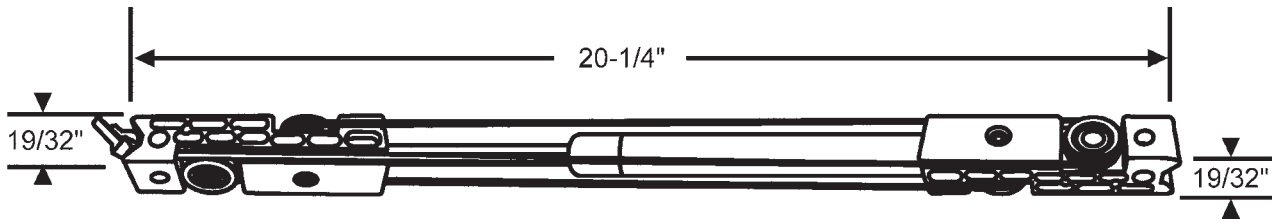

Part Number	Suggested Weight Per Pair	Suggested Weight 4 Per Sash	
84S-20-1	9 to 12 lbs.	10 to 24 lbs.	w/60-518 attached
84S-20-5	9 to 12 lbs.	10 to 24 lbs.	w/900-18354 attached
84S-25-1	12 to 15 lbs.	24 to 30 lbs.	w/60-518 attached
84S-25-5	12 to 15 lbs.	24 to 30 lbs.	w/900-18354 attached
84S-30-1	15-18 lbs.	30-36 lbs.	w/60-518 attached
84S-30-5	15-18 lbs.	30-36 lbs.	w/900-18354 attached
84S-35-1	18 to 21 lbs.	36 to 42 lbs.	w/60-518 attached
84S-35-5	18 to 21 lbs.	36 to 42 lbs.	w/900-18354 attached
84S-40-1	21 to 24 lbs.	42 to 48 lbs.	w/60-518 attached
84S-40-5	21 to 24 lbs.	42 to 48 lbs.	w/900-18354 attached
84S-45-1	24 to 27 lbs.	48 to 54 lbs.	w/60-518 attached
84S-45-5	24 to 27 lbs.	48 to 54 lbs.	w/900-18354 attached
84S-50-1	27 to 30 lbs.	54 to 60 lbs.	w/60-518 attached
84S-50-5	27 to 30 lbs.	54 to 60 lbs.	w/900-18354 attached
84S-55-1	30 to 32 lbs.	60 to 64 lbs.	w/60-518 attached
84S-55-5	30 to 32 lbs.	60 to 64 lbs.	w/900-18354 attached
84S-60-1	32 to 36 lbs.	64 to 72 lbs.	w/60-518 attached
84S-60-5	32 to 36 lbs.	64 to 72 lbs.	w/900-18354 attached
84S-65-1	36 to 39 lbs.	72 to 78 lbs.	w/60-518 attached
84S-65-5	36 to 39 lbs.	72 to 78 lbs.	w/900-18354 attached
84S-70-1	39 to 43 lbs.	78 to 86 lbs.	w/60-518 attached
84S-70-5	39 to 43 lbs.	78 to 86 lbs.	w/900-18354 attached
84S-75-1	43 to 45 lbs.	86 to 90 lbs.	w/60-518 attached
84S-75-5	43 to 45 lbs.	86 to 90 lbs.	w/900-18354 attached
84S-80-1	45 to 48 lbs.	90 to 96 lbs.	w/60-518 attached
84S-80-5	45 to 48 lbs.	90 to 96 lbs.	w/900-18354 attached
84S-85-1	48 to 52 lbs.	96 to 104 lbs.	w/60-518 attached
84S-85-5	48 to 52 lbs.	96 to 104 lbs.	w/900-18354 attached
84S-90-1	52 to 55 lbs.	104 to 110 lbs.	w/60-518 attached
84S-90-5	52 to 55 lbs.	104 to 110 lbs.	w/900-18354 attached
84S-95-1	55 to 58 lbs.	110 to 116 lbs.	w/60-518 attached
84S-95-5	55 to 58 lbs.	110 to 116 lbs.	w/900-18354 attached
84S-100-1	58 to 62 lbs.	116 to 124 lbs.	w/60-518 attached
84S-100-5	58 to 62 lbs.	116 to 124 lbs.	w/900-18354 attached
84S-110-1	62 to 64 lbs.	124 to 128 lbs.	w/60-518 attached
84S-110-5	52 to 64 lbs.	124 to 128 lbs.	w/900-18354 attached

### OPTIONAL END BRACKETS

-5

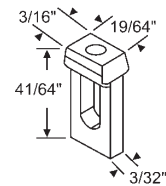

#### 900-18354

If ordering with our optional 900-18354 clip attached, Please add "-5" after the part number

-1

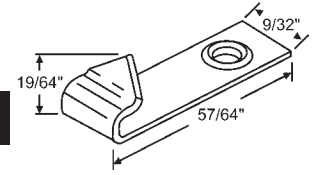

#### 60-518

If ordering with our optional 60-518 clip attached, Please add "-1" after the part number

Contact Account Manager For Pricing



## 85 SERIES BALANCES

### 5/8" TILT TUBE BALANCE 9/16" but considered 5/8" in the trade.

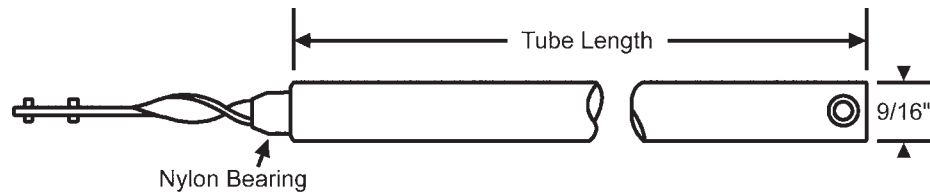

#### Ordering Information

1. Measure metal tube length. (Do not include nylon bearing.)
2. Identify color of bearing (e.g. red, blue or black) and select corresponding part number from the chart below.
3. If different pin configuration, select appropriate pin configuration from the chart and add the number to the end of the part number.

**Note:** Accessories must be ordered separately, see pages 83-92.

#### General Information

1. Maximum tube balance length available is 60".
2. Red and blue bearings are for sashes weighing up to 30 lbs; the black bearing with the nyclad tip is for sashes weighing up to 40 lbs. Please consult your sales representative for special ordering information.
3. In most cases red bearing can be used in place of white bearing. Check with sales representative for availability of white bearing.
4. Now Available in White.
5. The appropriate tensioning tools are 85-511 and 85-515 as shown on pages 87 and 96.
6. All rod lengths are standard.

Tube Length	Red Bearing (up to 30 lbs.)	Blue Bearing (up to 30 lbs.)	Black Bearing (30 - 40 lbs.)
12"	85-12R	85-12B	---
13"	85-13R	85-13B	---
14"	85-14R	85-14B	---
15"	85-15R	85-15B	---
16"	85-16R	85-16B	---
17"	85-17R	85-17B	85-17HD
18"	85-18R	85-18B	85-18HD
19"	85-19R	85-19B	85-19HD
20"	85-20R	85-20B	85-20HD
21"	85-21R	85-21B	85-21HD
22"	85-22R	85-22B	85-22HD
23"	85-23R	85-23B	85-23HD
24"	85-24R	85-24B	85-24HD
25"	85-25R	85-25B	85-25HD
26"	85-26R	85-26B	85-26HD
27"	85-27R	85-27B	85-27HD
28"	85-28R	85-28B	85-28HD
29"	85-29R	85-29B	85-29HD
30"	85-30R	85-30B	85-30HD
31"	85-31R	85-31B	85-31HD
32"	85-32R	85-32B	85-32HD
33"	85-33R	---	85-33HD
34"	85-34R	---	85-34HD
35"	85-35R	---	85-35HD
36"	85-36R	---	85-36HD
37"	85-37R	---	85-37HD
38"	85-38R	---	85-38HD

Tube Length	Red Bearing (up to 30 lbs.)	Black Bearing (30 - 40 lbs.)
39"	85-39R	85-39HD
40"	85-40R	85-40HD
41"	85-41R	85-41HD
42"	85-42R	85-42HD
43"	85-43R	85-43HD
44"	85-44R	85-44HD
45"	85-45R	85-45HD
46"	85-46R	85-46HD
47"	85-47R	85-47HD
48"	85-48R	85-48HD
49"	85-49R	85-49HD
50"	85-50R	85-50HD
51"	85-51R	85-51HD
52"	---	85-52HD
53"	---	85-53HD
54"	---	85-54HD
55"	---	85-55HD
56"	---	85-56HD
57"	---	85-57HD
58"	---	85-58HD
59"	---	85-59HD
60"	---	85-60HD
61"	---	85-61HD
62"	---	85-62HD
63"	---	85-63HD
64"	---	85-64HD
65"	---	85-65HD
72"	---	85-72HD

### 5/8" NON-TILT TUBE BALANCE 9/16" but considered 5/8" in the trade.

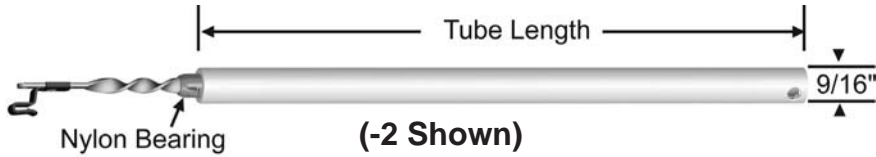

#### Ordering Information

1. Measure metal tube length. (Do not include nylon bearing.)
  2. Identify color of bearing (e.g. red, blue or black) and select corresponding part column from the chart below.
  3. Select our corresponding part number from the chart below
  4. Identify appropriate end bracket to be attached from the illustrations shown then add -1 or -2 to complete our part number.
  5. Add suffix W to end of part number when ordering with white tube
- Example: 32" Balance with black bearing, #75-540 attached in white = 85M-32HD-1W

#### General Information

1. Maximum tube balance length available is 60".
2. Red and blue bearings are for sashes weighing up to 30 lbs; the black bearing with the nyclad tip is for sashes weighing up to 40 lbs.
3. In most cases red bearing can be used in place of white bearing.
4. Available in Mill (Standard) or White (Special Order) tube.
5. The appropriate tensioning tools are 85-511 and 85-515 as shown on pages 87 and 96.
6. All rod lengths are standard.

#### CARRIER BRACKETS

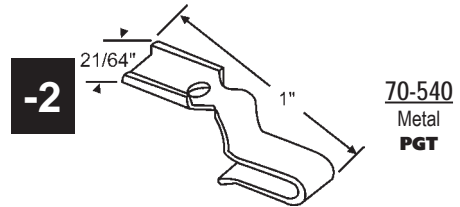
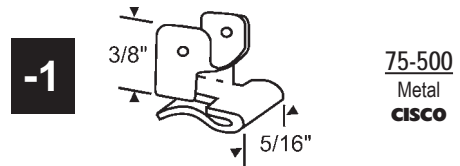

Tube Length	Red Bearing (up to 30 lbs.)	Blue Bearing (up to 30 lbs.)	Black Bearing (30 - 40 lbs.)
12"	85M-12R-	85M-12B-	---
13"	85M-13R-	85M-13B-	---
14"	85M-14R-	85M-14B-	---
15"	85M-15R-	85M-15B-	---
16"	85M-16R-	85M-16B-	---
17"	85M-17R-	85M-17B-	85M-17HD-
18"	85M-18R-	85M-18B-	85M-18HD-
19"	85M-19R-	85M-19B-	85M-19HD-
20"	85M-20R-	85M-20B-	85M-20HD-
21"	85M-21R-	85M-21B-	85M-21HD-
22"	85M-22R-	85M-22B-	85M-22HD-
23"	85M-23R-	85M-23B-	85M-23HD-
24"	85M-24R-	85M-24B-	85M-24HD-
25"	85M-25R-	85M-25B-	85M-25HD-
26"	85M-26R-	85M-26B-	85M-26HD-
27"	85M-27R-	85M-27B-	85M-27HD-
28"	85M-28R-	85M-28B-	85M-28HD-
29"	85M-29R-	85M-29B-	85M-29HD-
30"	85M-30R-	85M-30B-	85M-30HD-
31"	85M-31R-	85M-31B-	85M-31HD-
32"	85M-32R-	85M-32B-	85M-32HD-
33"	85M-33R-	85M-33B-	85M-33HD-
34"	85M-34R-	---	85M-34HD-
35"	85M-35R-	---	85M-35HD-

Tube Length	Red Bearing (up to 30 lbs.)	Black Bearing (30 - 40 lbs.)
36"	85M-36R-	85M-36HD-
37"	85M-37R-	85M-37HD-
38"	85M-38R-	85M-38HD-
39"	85M-39R-	85M-39HD-
40"	85M-40R-	85M-40HD-
41"	85M-41R-	85M-41HD-
42"	85M-42R-	85M-42HD-
43"	85M-43R-	85M-43HD-
44"	85M-44R-	85M-44HD-
45"	85M-45R-	85M-45HD-
46"	85M-46R-	85M-46HD-
47"	85M-47R-	85M-47HD-
48"	85M-48R-	85M-48HD-
49"	85M-49R-	85M-49HD-
50"	85M-50R-	85M-50HD-
51"	85M-51R-	85M-51HD-
52"	---	85M-52HD-
53"	---	85M-53HD-
54"	---	85M-54HD-
55"	---	85M-55HD-
56"	---	85M-56HD-
57"	---	85M-57HD-
58"	---	85M-58HD-
59"	---	85M-59HD-
60"	---	85M-60HD-

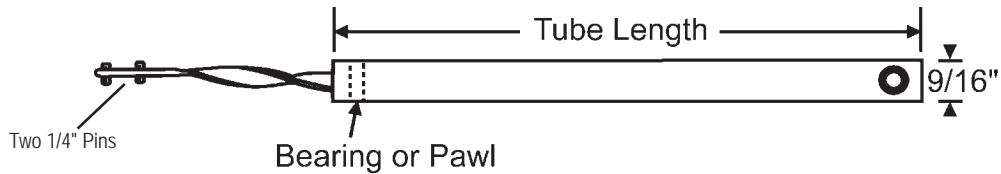

### Ordering Information

1. Measure plastic tube length.
2. Identify bearing color by looking down into the tube where the rod comes out.
3. Select the part number from the chart below if 2 1/4" pin configuration.
4. If different configuration, select appropriate pin configuration from the chart and add the number to the end of the part number.
5. \* 1/2" sizes are Special Order Only.

### General Information

1. In the past, various bearing (or pawl) colors were used to indicate different weight ranges for these balances. The colors used were white, red, blue, black and yellow. Currently the standard color for sashes weighing up to 30 lbs. is red and for 30 to 40 lbs, sash is yellow. If your sash weighs between 30 and up to 40 lbs. Please specify HD after the part number.  
Example: If ordering a 32" balance with a black tube for a 26 lb. sash, Your part # is 85-P32HD
2. Standard tube color is gray. If ordering white, place the letter "W" at the end of the part number. If ordering black, place the letter "B" at the end of the part number.
3. Appropriate tensioning tools are 85-511 and 85-515 as shown on pages 87 and 96.
4. Accessories must be ordered separately.

### Balance Pin Options

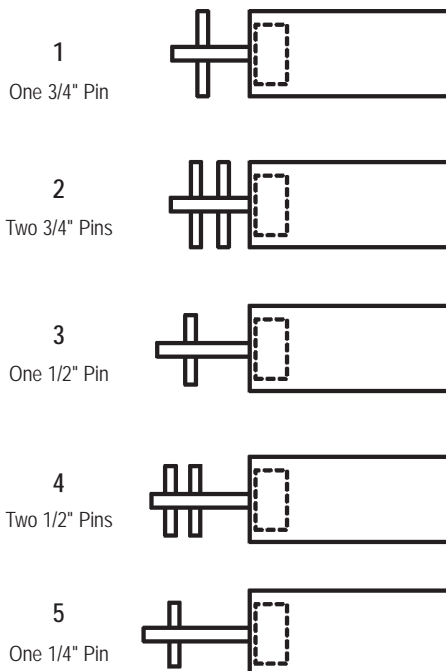

### Example Ordering Chart

Balance Length	Tube Color	Pin Configuration	Complete Part Number
26-1/2"	White	-	85-P26.5W
19"	Black	2	85-P19B-2

Tube Length	Part Number	Tube Length	Part Number
15"	85-P15	30"	85-P30
*15-1/2"	85-P15.5	*30-1/2"	85-P30.5
16"	85-P16	31"	85-P31
*16-1/2"	85-P16.5	*31-1/2"	85-P31.5
17"	85-P17	32"	85-P32
*17-1/2"	85-P17.5	*32-1/2"	85-P32.5
18"	85-P18	33"	85-P33
*18-1/2"	85-P18.5	*33-1/2"	85-P33.5
19"	85-P19	34"	85-P34
*19-1/2"	85-P19.5	*34-1/2"	85-P34.5
20"	85-P20	35"	85-P35
*20-1/2"	85-P20.5	*35-1/2"	85-P35.5
21"	85-P21	36"	85-P36
*21-1/2"	85-P21.5	*36-1/2"	85-P36.5
22"	85-P22	37"	85-P37
*22-1/2"	85-P22.5	*37-1/2"	85-P37.5
23"	85-P23	38"	85-P38
*23-1/2"	85-P23.5	*38-1/2"	85-P38.5
24"	85-P24	39"	85-P39
*24-1/2"	85-P24.5	*39-1/2"	85-P39.5
25"	85-P25	40"	85-P40
*25-1/2"	85-P25.5	*40-1/2"	85-P40.5
26"	85-P26	41"	85-P41
*26-1/2"	85-P26.5	*41-1/2"	85-P41.5
27"	85-P27	42"	85-P42
*27-1/2"	85-P27.5	*42-1/2"	85-P42.5
28"	85-P28	43"	85-P43
*28-1/2"	85-P28.5	*43-1/2"	85-P43.5
29"	85-P29	44"	85-P44
*29-1/2"	85-P29.5	*44-1/2"	85-P44.5
		45"	85-P45

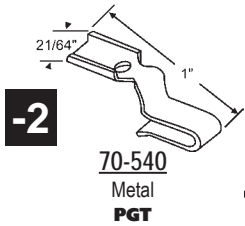

To make the balance non-tilt, add suffix -2 to part number.

### 5/8" PRE-TENSIONED TILT METAL TUBE BALANCE 9/16" but considered 5/8" in the trade.

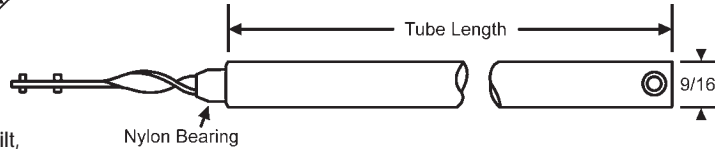

### Ordering Information

1. Identify number stamped on balance.
2. Select our corresponding part number from the chart below.

Note: Accessories must be ordered separately, see pages 83-92.

### Support Heavier Sash Weights with Superior Operating Performance

- Spiral Balances are already known for their consistent operating forces in raising and lowering sash.
- 85Z Series offers increased lift assistance to operation of heavier sash - up to 60 lbs - well beyond conventional spiral and block & tackle products available today.

- 85Z Series also eliminates the need to tension product on the job or the factory floor.
- If you currently have a window using a 5/8" spiral platform, mounting 85Z Series will remain the same. No tensioning required. It operates in the same style tilt shoes in use today. It should also fit into most windows currently utilizing our 88L Series or 60 Series Balances.

- Outwardly, it looks virtually identical to our 85 Series Balance.
- 85Z Series will fit into the same jambs that 85 Series fits into and provides a similar look.
- It's pre-tensioned. Many of our customers have been asking for a pre-tensioned spiral product. Here it is. Just mount the balance, connect the carrier, and it's done!

Other sizes available. Contact your Account Representative.

Tube Length	Number Stamped on Balance	Weight Capacity	Our Part Number	Tube Length	Number Stamped on Balance	Weight Capacity	Our Part Number	Tube Length	Number Stamped on Balance	Weight Capacity	Our Part Number	Tube Length	Number Stamped on Balance	Weight Capacity	Our Part Number
15"	E15A	4 to 8 lbs	85Z-E15A	21"	E21B	8 to 11 lbs	85Z-E21B	26"	E26B	8 to 11 lbs	85Z-E26B	31"	E31B	8 to 11 lbs	85Z-E31B
15"	E15B	8 to 11 lbs	85Z-E15B	21"	E21C	11 to 14 lbs	85Z-E21C	26"	E26C	11 to 14 lbs	85Z-E26C	31"	E31C	11 to 14 lbs	85Z-E31C
15"	E15C	11 to 14 lbs	85Z-E15C	21"	E21D	14 to 18 lbs	85Z-E21D	26"	E26D	14 to 18 lbs	85Z-E26D	31"	E31D	14 to 18 lbs	85Z-E31D
15"	E15D	14 to 18 lbs	85Z-E15D	21"	E21E	18 to 24 lbs	85Z-E21E	26"	E26E	18 to 24 lbs	85Z-E26E	31"	E31E	18 to 24 lbs	85Z-E31E
15"	E15E	18 to 24 lbs	85Z-E15E	21"	E21F	24 to 30 lbs	85Z-E21F	26"	E26F	24 to 30 lbs	85Z-E26F	31"	E31F	24 to 30 lbs	85Z-E31F
15"	E15F	24 to 28 lbs	85Z-E15F	21"	E21G	30 to 35 lbs	85Z-E21G	26"	E26G	30 to 35 lbs	85Z-E26G	31"	E31G	30 to 35 lbs	85Z-E31G
16"	E16A	4 to 8 lbs	85Z-E16A	21"	E21H	35 to 40 lbs	85Z-E21H	26"	E26H	35 to 40 lbs	85Z-E26H	31"	E31H	35 to 40 lbs	85Z-E31H
16"	E16B	8 to 11 lbs	85Z-E16B	21"	E21J	40 to 47 lbs	85Z-E21J	26"	E26J	40 to 47 lbs	85Z-E26J	31"	E31J	40 to 47 lbs	85Z-E31J
16"	E16C	11 to 14 lbs	85Z-E16C	21"	E21K	47 to 54 lbs	85Z-E21K	26"	E26K	47 to 54 lbs	85Z-E26K	31"	E31K	47 to 54 lbs	85Z-E31K
16"	E16D	14 to 18 lbs	85Z-E16D	21"	E21M	54 to 60 lbs	85Z-E21M	26"	E26M	54 to 60 lbs	85Z-E26M	31"	E31M	54 to 60 lbs	85Z-E31M
16"	E16E	18 to 24 lbs	85Z-E16E	22"	E22B	8 to 11 lbs	85Z-E22B	27"	E27B	8 to 11 lbs	85Z-E27B	32"	E32B	8 to 11 lbs	85Z-E32B
16"	E16F	24 to 28 lbs	85Z-E16F	22"	E22C	11 to 14 lbs	85Z-E22C	27"	E27C	11 to 14 lbs	85Z-E27C	32"	E32C	11 to 14 lbs	85Z-E32C
17"	E17A	4 to 8 lbs	85Z-E17A	22"	E22D	14 to 18 lbs	85Z-E22D	27"	E27D	14 to 18 lbs	85Z-E27D	32"	E32D	14 to 18 lbs	85Z-E32D
17"	E17B	8 to 11 lbs	85Z-E17B	22"	E22E	18 to 24 lbs	85Z-E22E	27"	E27E	18 to 24 lbs	85Z-E27E	32"	E32E	18 to 24 lbs	85Z-E32E
17"	E17C	11 to 14 lbs	85Z-E17C	22"	E22F	24 to 30 lbs	85Z-E22F	27"	E27F	24 to 30 lbs	85Z-E27F	32"	E32F	24 to 30 lbs	85Z-E32F
17"	E17D	14 to 18 lbs	85Z-E17D	22"	E22G	30 to 35 lbs	85Z-E22G	27"	E27G	30 to 35 lbs	85Z-E27G	32"	E32G	30 to 35 lbs	85Z-E32G
17"	E17E	18 to 24 lbs	85Z-E17E	22"	E22H	35 to 40 lbs	85Z-E22H	27"	E27H	35 to 40 lbs	85Z-E27H	32"	E32H	35 to 40 lbs	85Z-E32H
17"	E17F	24 to 30 lbs	85Z-E17F	22"	E22J	40 to 47 lbs	85Z-E22J	27"	E27J	40 to 47 lbs	85Z-E27J	32"	E32J	40 to 47 lbs	85Z-E32J
17"	E17G	30 to 35 lbs	85Z-E17G	22"	E22K	47 to 54 lbs	85Z-E22K	27"	E27K	47 to 54 lbs	85Z-E27K	32"	E32K	47 to 54 lbs	85Z-E32K
17"	E17H	35 to 40 lbs	85Z-E17H	22"	E22M	54 to 60 lbs	85Z-E22M	27"	E27M	54 to 60 lbs	85Z-E27M	32"	E32M	54 to 60 lbs	85Z-E32M
18"	E18B	8 to 11 lbs	85Z-E18B	23"	E23B	8 to 11 lbs	85Z-E23B	28"	E28B	8 to 11 lbs	85Z-E28B	33"	E33C	12 to 14 lbs	85Z-E33C
18"	E18C	11 to 14 lbs	85Z-E18C	23"	E23C	11 to 14 lbs	85Z-E23C	28"	E28C	11 to 14 lbs	85Z-E28C	33"	E33D	14 to 18 lbs	85Z-E33D
18"	E18D	14 to 18 lbs	85Z-E18D	23"	E23D	14 to 18 lbs	85Z-E23D	28"	E28D	14 to 18 lbs	85Z-E28D	33"	E33E	18 to 24 lbs	85Z-E33E
18"	E18E	18 to 24 lbs	85Z-E18E	23"	E23E	18 to 24 lbs	85Z-E23E	28"	E28E	18 to 24 lbs	85Z-E28E	33"	E33F	24 to 30 lbs	85Z-E33F
18"	E18F	24 to 30 lbs	85Z-E18F	23"	E23F	24 to 30 lbs	85Z-E23F	28"	E28F	24 to 30 lbs	85Z-E28F	33"	E33G	30 to 35 lbs	85Z-E33G
18"	E18G	30 to 35 lbs	85Z-E18G	23"	E23G	30 to 35 lbs	85Z-E23G	28"	E28G	30 to 35 lbs	85Z-E28G	33"	E33H	35 to 40 lbs	85Z-E33H
18"	E18H	35 to 40 lbs	85Z-E18H	23"	E23H	35 to 40 lbs	85Z-E23H	28"	E28H	35 to 40 lbs	85Z-E28H	33"	E33J	40 to 47 lbs	85Z-E33J
18"	E18J	40 to 47 lbs	85Z-E18J	23"	E23J	40 to 47 lbs	85Z-E23J	28"	E28J	40 to 47 lbs	85Z-E28J	33"	E33K	47 to 54 lbs	85Z-E33K
18"	E18K	47 to 54 lbs	85Z-E18K	23"	E23K	47 to 54 lbs	85Z-E23K	28"	E28K	47 to 54 lbs	85Z-E28K	33"	E33M	54 to 60 lbs	85Z-E33M
18"	E18M	54 to 60 lbs	85Z-E18M	23"	E23M	54 to 60 lbs	85Z-E23M	28"	E28M	54 to 60 lbs	85Z-E28M	34"	E34C	12 to 14 lbs	85Z-E34C
19"	E19B	8 to 11 lbs	85Z-E19B	24"	E24B	8 to 11 lbs	85Z-E24B	29"	E29B	8 to 11 lbs	85Z-E29B	34"	E34D	14 to 18 lbs	85Z-E34D
19"	E19C	11 to 14 lbs	85Z-E19C	24"	E24C	11 to 14 lbs	85Z-E24C	29"	E29C	11 to 14 lbs	85Z-E29C	34"	E34E	18 to 24 lbs	85Z-E34E
19"	E19D	14 to 18 lbs	85Z-E19D	24"	E24D	14 to 18 lbs	85Z-E24D	29"	E29D	14 to 18 lbs	85Z-E29D	34"	E34F	24 to 30 lbs	85Z-E34F
19"	E19E	18 to 24 lbs	85Z-E19E	24"	E24E	18 to 24 lbs	85Z-E24E	29"	E29E	18 to 24 lbs	85Z-E29E	34"	E34G	30 to 35 lbs	85Z-E34G
19"	E19F	24 to 30 lbs	85Z-E19F	24"	E24F	24 to 30 lbs	85Z-E24F	29"	E29F	24 to 30 lbs	85Z-E29F	34"	E34H	35 to 40 lbs	85Z-E34H
19"	E19G	30 to 35 lbs	85Z-E19G	24"	E24G	30 to 35 lbs	85Z-E24G	29"	E29G	30 to 35 lbs	85Z-E29G	34"	E34J	40 to 47 lbs	85Z-E34J
19"	E19H	35 to 40 lbs	85Z-E19H	24"	E24H	35 to 40 lbs	85Z-E24H	29"	E29H	35 to 40 lbs	85Z-E29H	34"	E34K	47 to 54 lbs	85Z-E34K
19"	E19J	40 to 47 lbs	85Z-E19J	24"	E24J	40 to 47 lbs	85Z-E24J	29"	E29J	40 to 47 lbs	85Z-E29J	34"	E34M	54 to 60 lbs	85Z-E34M
19"	E19K	47 to 54 lbs	85Z-E19K	24"	E24K	47 to 54 lbs	85Z-E24K	29"	E29K	47 to 54 lbs	85Z-E29K	35"	E35C	12 to 14 lbs	85Z-E35C
19"	E19M	54 to 60 lbs	85Z-E19M	24"	E24M	54 to 60 lbs	85Z-E24M	29"	E29M	54 to 60 lbs	85Z-E29M	35"	E35D	14 to 18 lbs	85Z-E35D
20"	E20B	8 to 11 lbs	85Z-E20B	25"	E25B	8 to 11 lbs	85Z-E25B	30"	E30B	8 to 11 lbs	85Z-E30B	35"	E35E	18 to 24 lbs	85Z-E35E
20"	E20C	11 to 14 lbs	85Z-E20C	25"	E25C	11 to 14 lbs	85Z-E25C	30"	E30C	11 to 14 lbs	85Z-E30C	35"	E35F	24 to 30 lbs	85Z-E35F
20"	E20D	14 to 18 lbs	85Z-E20D	25"	E25D	14 to 18 lbs	85Z-E25D	30"	E30D	14 to 18 lbs	85Z-E30D	35"	E35G	30 to 35 lbs	85Z-E35G
20"	E20E	18 to 24 lbs	85Z-E20E	25"	E25E	18 to 24 lbs	85Z-E25E	30"	E30E	18 to 24 lbs	85Z-E30E	35"	E35H	35 to 40 lbs	85Z-E35H
20"	E20F	24 to 30 lbs	85Z-E20F	25"	E25F	24 to 30 lbs	85Z-E25F	30"	E30F	24 to 30 lbs	85Z-E30F	35"	E35J	40 to 47 lbs	85Z-E35J
20"	E20G	30 to 35 lbs	85Z-E20G	25"	E25G	30 to 35 lbs	85Z-E25G	30"	E30G	30 to 35 lbs	85Z-E30G	35"	E35K	47 to 54 lbs	85Z-E35K
20"	E20H	35 to 40 lbs	85Z-E20H	25"	E25H	35 to 40 lbs	85Z-E25H	30"	E30H	35 to 40 lbs	85Z-E30H	35"	E35M	54 to 60 lbs	85Z-E35M
20"	E20J	40 to 47 lbs	85Z-E20J	25"	E25J	40 to 47 lbs	85Z-E25J	30"	E30J	40 to 47 lbs	85Z-E30J				
20"	E20K	47 to 54 lbs	85Z-E20K	25"	E25K	47 to 54 lbs	85Z-E25K	30"	E30K	47 to 54 lbs	85Z-E30K				
20"	E20M	54 to 60 lbs	85Z-E20M	25"	E25M	54 to 60 lbs	85Z-E25M	30"	E30M	54 to 60 lbs	85Z-E30M				

## 85 SERIES BALANCE ACCESSORIES

### PIVOT BARS

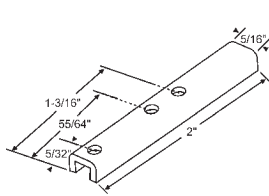

**900-14310**  
Stainless Steel  
**FIBERLUX**

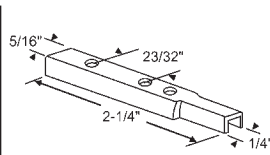

**85-557**  
Stamped. Use with 83-506  
Pivot Lock Shoe.  
**ROLLYSON**

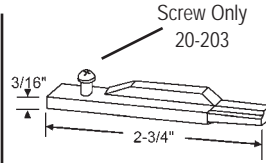

**85-500**  
Die Cast with Screw. Use with  
85-517 Pivot Lock Shoe.  
**TROCAL**

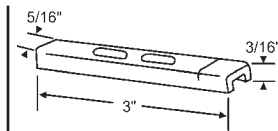

**85-513**  
Stamped

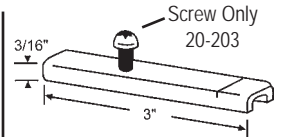

**85-501**  
Stamped with Screw  
**ACORN/NORANDEX**

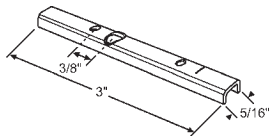

**85-5025**

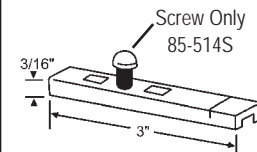

**85-514**  
Stamped

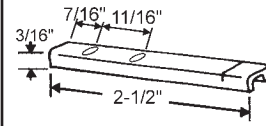

**85-591E**  
Stamped

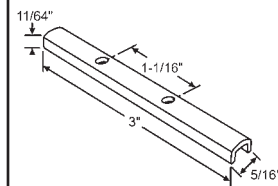

**900-17544**

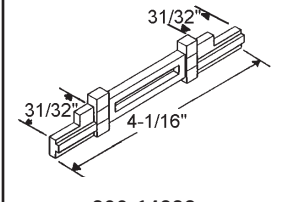

**900-14299**  
Die Cast  
**SWS**

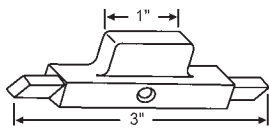

**900-10700**  
Die Cast  
**SEASONALL**

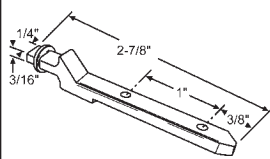

**85-5005**  
Zinc Die Cast

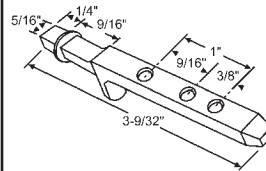

**85-5003**  
Die Cast  
**SIMONTON**

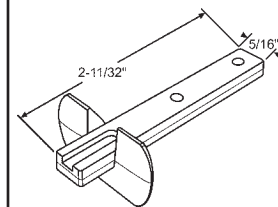

**900-22450**  
"Old Style" Metal Die Cast

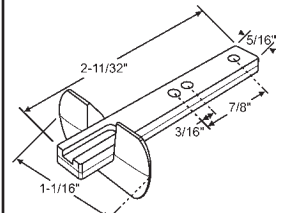

**900-22450NS**  
"New Style" Metal Die Cast

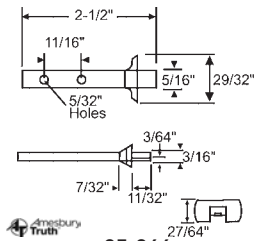

**85-866**  
Die Cast  
**SILVERLINE**

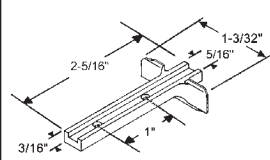

**85-718**  
Die Cast  
**SILVERLINE**

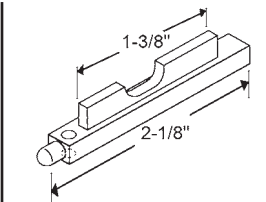

**85-698**  
Bar Only. Die Cast  
**BETTER-BILT**

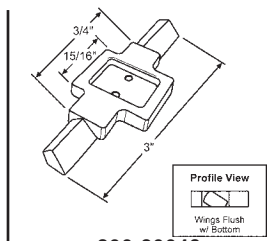

**900-20043**  
Old Style

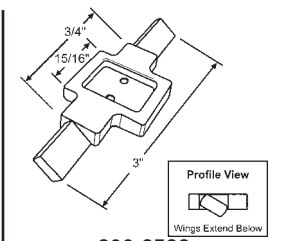

**900-8599**  
New Style. Die Cast  
**TRACO**

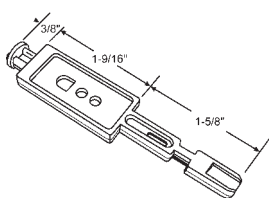

**900-18822**  
Die Cast  
**ACRO/SLOCMB**

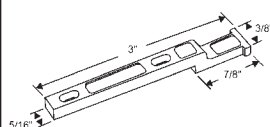

**85-852**  
Die Cast

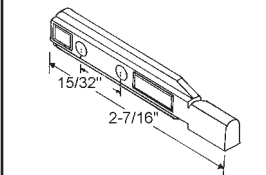

**900-18821**  
RH (shown) and LH Set  
Die Cast

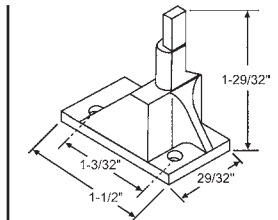

**900-13070A**  
Die Cast. Sold in sets only.

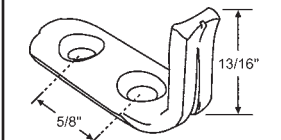

**85-5035**  
Sash Pivot Pin Kit. Kit Includes  
two Sash Pivot Pins w/ Screws  
**PEACHTREE**

# SASH SUPPORT SYSTEMS

## 85 SERIES BALANCE ACCESSORIES

### PIVOT BARS

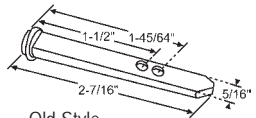

Old Style  
Use: 85-864

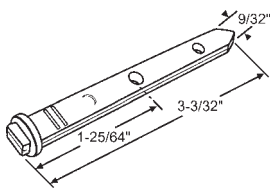

**900-21355**  
Zinc Die Cast

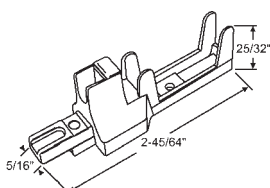

**85-744**  
Die Cast

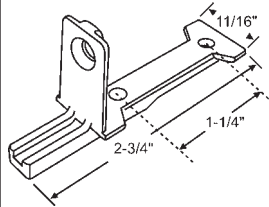

**85-766**  
**SPECTUS**

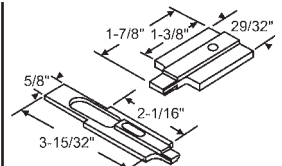

**85-822**  
Sold in sets only (1 short, 1 long).  
Stamped. Used with 85-525 Pivot  
Lock Shoe.  
**THERMALGARD**

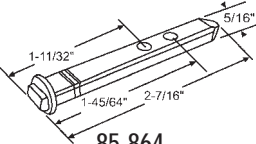

**85-864**  
Die Cast

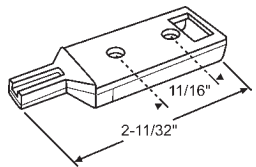

**85-788NW**  
Zinc Die Cast (No Wings)

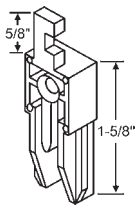

**900-18446A**  
Die Cast. Sold in sets only.  
**HARVEY**

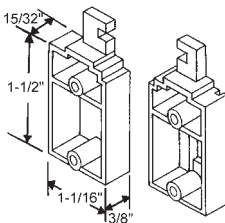

**85-564**  
Die Cast  
**HARVEY**

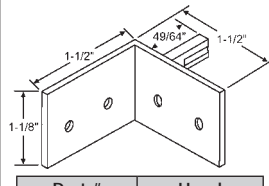

Part #	Hand
900-16398LH	Shown
900-16398RH	Opposite

Sash Pivot Angle Bracket  
Aluminum

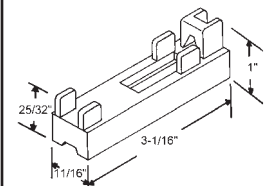

**900-20368**  
Bottom Pivot Bar Corner  
Used with 85-717 & 85-718  
**SILVERLINE**

### PIVOT HOUSINGS

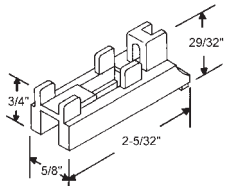

**85-717**  
White. Use with 85-718 Pivot Bar.  
**SILVERLINE**

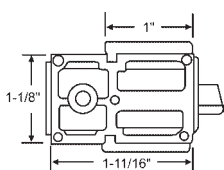

**900-12809BA**  
Sold in sets only  
Black  
**AMACOR**

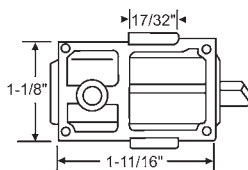

**900-12810BA**  
Sold in sets only  
Black  
**AMACOR**

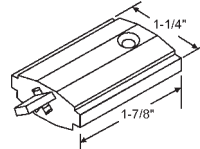

Part #	Hand
900-2367RH	Shown
900-2367LH	Opposite

Black  
**ALENCO**

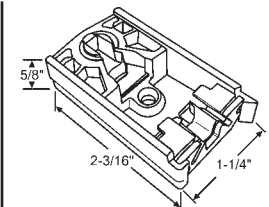

**85-5016**  
POS Lock w/ Torque Plate

### LOCKING TERMINAL

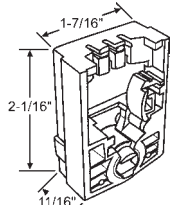

**85-973**  
**REPUBLIC**

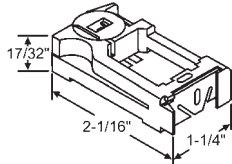

**85-503**  
Blue Cam  
Cam Opening: 5/16" x 3/16"  
**ACORN/NORANDEX**

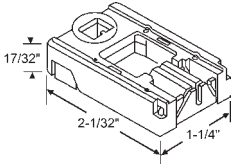

**85-516**  
Tan Cam  
Cam Opening: 3/8" x 3/16"  
**FIBERLUX**

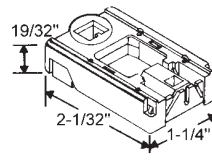

**85-505**  
Die Cast Cam  
No Longer Available  
Use: 85-517

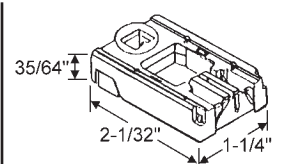

**85-541**  
Off-White Cam with Red Brake  
Cam Opening: 3/8" x 5/32"

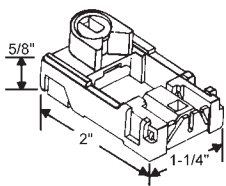

**85-518**  
Red Cam  
Cam Opening: 3/8" x 3/16"  
**TRACO**

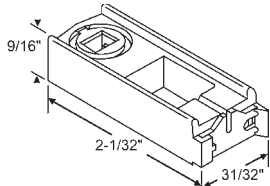

**85-544**  
White Cam  
Cam Opening: 5/16" x 3/16"

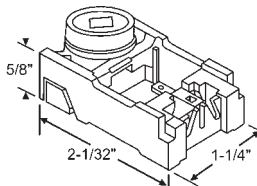

**85-525**  
Black Cam  
Cam Opening: 5/16" x 3/16"  
**THERMALGARD**

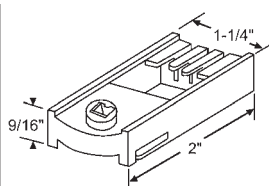

**900-12210**  
White Cam  
Cam Opening: 5/16" x 3/16"

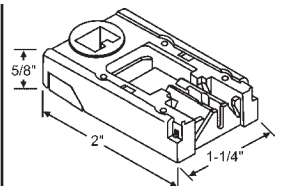

**85-540**  
Black Cam  
Cam Opening: 5/16" x 3/16"  
Uses 85-550 Spacer.

## 85 SERIES BALANCE ACCESSORIES

### PIVOT LOCK SHOES

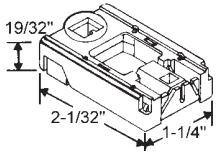

**85-517**  
Black Cam  
Cam Opening: 3/8" x 3/16"

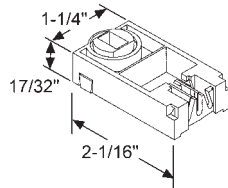

**85-590**  
Blue Cam & Blue Brake w/mach width opening of 1.310  
Cam Openings = 5/16" x 3/16"

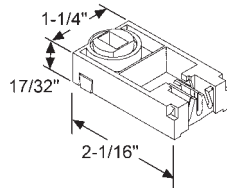

**85-588**  
Blue Cam & Black Brake Puck  
Cam Opening: 5/16" x 3/16"

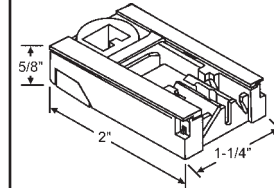

**85-589**  
Black Cam

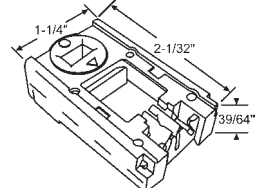

**85-534**  
Light Green Cam

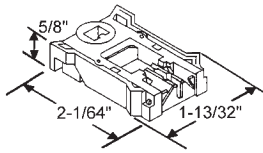

**85-539**  
Natural Cam  
Cam Opening: 5/16" x 3/16".  
Can be used in place of 85-540 with 85-550

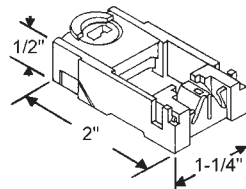

**85-531**  
Die Cast Cam  
Cam Opening: 5/16" x 3/16".  
**WINTERSEAL**

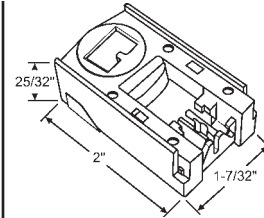

**85-5045**

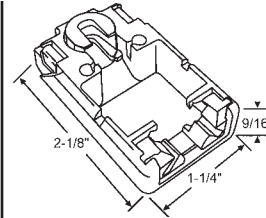

**900-21341**  
Blue-Gray Pad - .055 Pad Projection. Replaces White Pad.

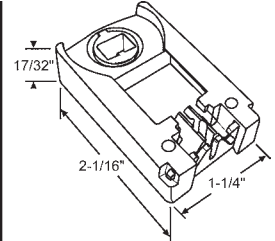

**85-807**  
w/White Cam  
**CALDWELL**

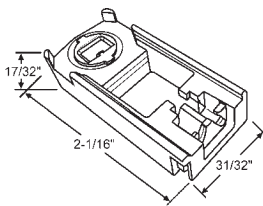

**85-802**  
w/Black Cam

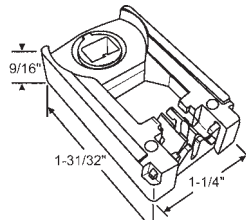

**85-804**  
Black Cam

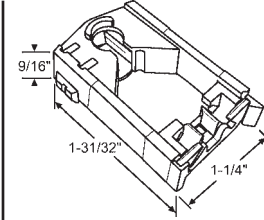

**85-570**  
Black Enforcer

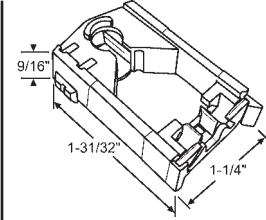

**85-800**  
Natural Cam  
Orange Locking Pad

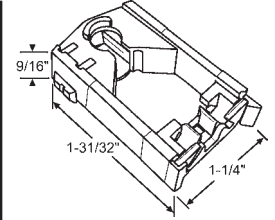

**85-801**  
Natural Cam  
Navy Blue Locking Pad

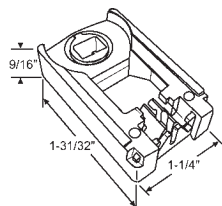

**85-805**  
Orange Cam

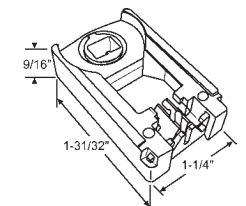

**85-806**  
Navy Blue Cam

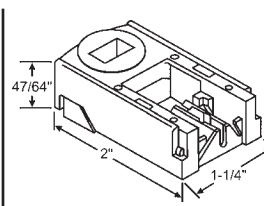

**85-537**  
Natural Cam  
Cam Opening: 1/2" x 5/16"

### PIVOT LOCK SHOE FILLERS

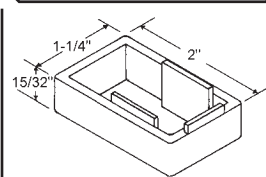

**85-559**  
Used with Pivot Lock Shoe 85-517.  
**MANNIX**

### SPACER SHIM

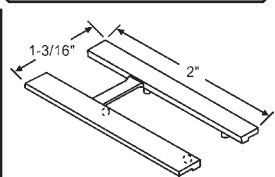

**85-524**  
Used with 85-517  
1/32" Thick

### SLIDE GUIDES

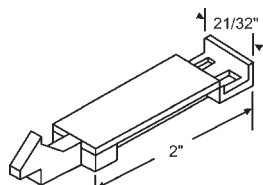

**85-601**  
White  
**TRACO**

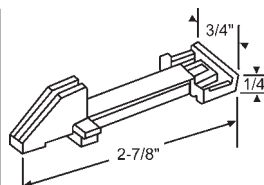

Part #	Color
85-506	Natural
85-506B	Black

**GRAHAM**

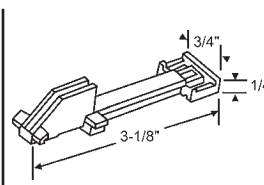

Part #	Color
85-507	White
85-507B	Black

**WEATHERCRAFT**

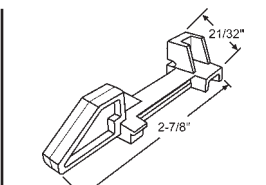

Part #	Hand
85-772RH	Shown
85-772LH	Opposite

Slide Bolt

### SPRING HOOK

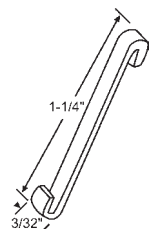

**85-510**  
Metal  
**TRACO**

# SASH SUPPORT SYSTEMS

## 85 SERIES BALANCE ACCESSORIES

### SPRING

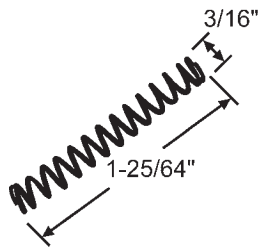

85-509

### DUST COVER

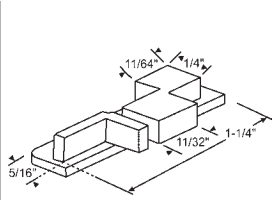

Part #	Hand
900-6783RH	Shown
900-6783LH	Opposite

White

### HOUSING PLUG

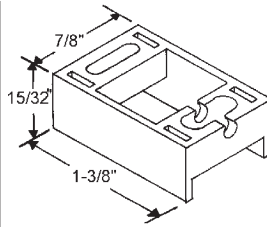

Part #	Color
900-5789	White
900-5789BR	Brown
900-5789BG	Beige

**FIBERLUX**

### TAMP-R-LOCKS

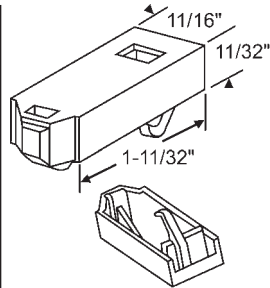

85-606

Black  
Used with 85-518

### SLIDE GUIDES

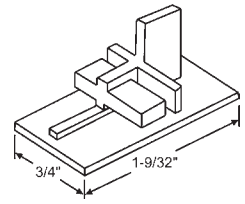

Part #	Color
85-605A	Black
85-605WA	White

Lower. Sold in sets only.  
**TRACO**

### VENT LOCKS

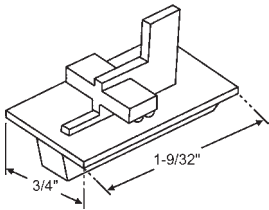

No Longer Available  
Use: 85-603 or 85-603N

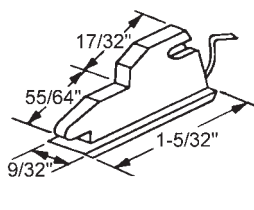

Part #	Color
900-11406	White
900-11406B	Black
900-11406BR	Brown
900-11406BG	Beige

**ALL WEATHER/ROLLYSON**

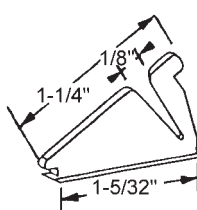

Part #	Color
900-12557	White

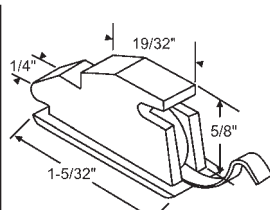

Part #	Color
900-2433	White
900-2433BG	Beige

**FIBERLUX**

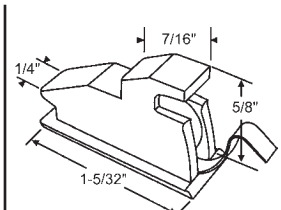

Part #	Color
900-16381	Beige

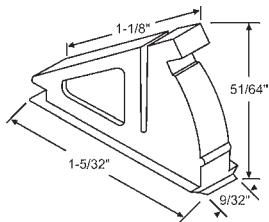

Part #	Color
900-16594	White

**FIBERLUX**

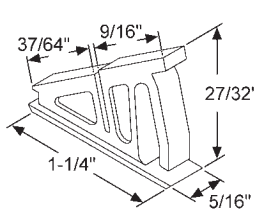

Part #	Color
900-19788	Beige
900-19788B	Black
900-19788W	White

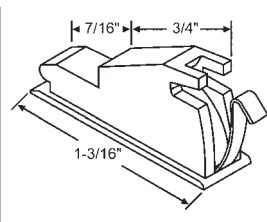

Part #	Color
900-20055W	White
900-20055BG	Beige
900-20055LGY	Light Gray

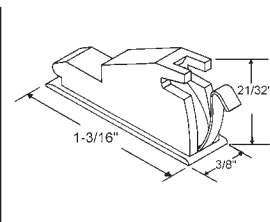

Part #	Color
900-7796	White

No longer available.  
Use: 900-20055W  
**SEASONALL**

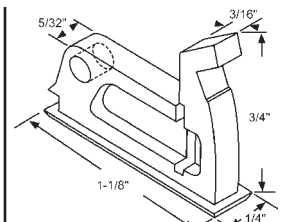

Part #	Color
85-825BZ	Dark Bronze

### VENT STOP

### SASH STOPS

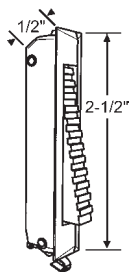

Part #	Color
900-13386	White
900-13386BR	Brown
900-13386BG	Beige

**TRACO**

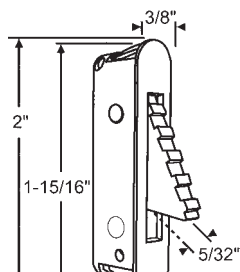

Part #	Color
85-985BG	Beige
85-985W	White

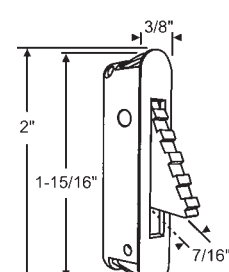

Part #	Color
900-20122W	White
900-20122BR	Dark Brown

Limit Latch

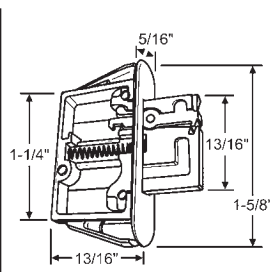

900-21461  
White  
Universal Vent Lock

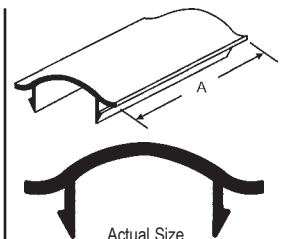

Part #	Color	"A"
900-8547B	Black	3"
900-8547B-4	Black	4"
900-8547B-6	Black	6"
900-8547B-24	Black	24"
900-8547W-6	White	6"



## 85 SERIES BALANCE ACCESSORIES

### SASH STOPS

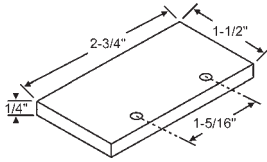

**900-21112**  
Black  
Anodized Aluminum

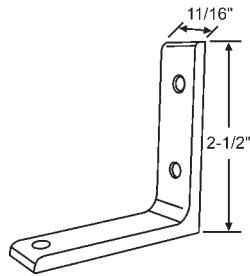

**88-700**  
Anodized Aluminum Angle Stop  
- Black

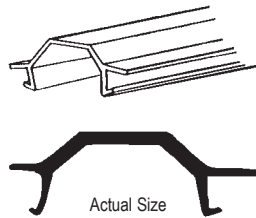

Part #	Length
900-14211	7'
900-14211-3	3-1/4"
900-14211BL	1"

Black

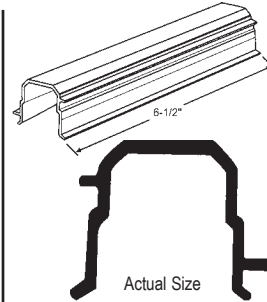

Part #	Color
900-16324B-6	Black
900-16324W-6	White

Plastic

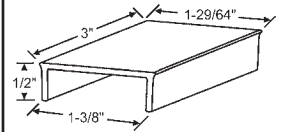

**85-6002WX**  
White  
**PGT**

### Hole Plug

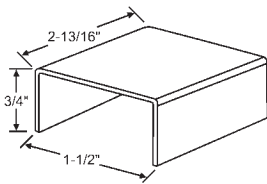

**85-6003WX**  
White  
**PGT**

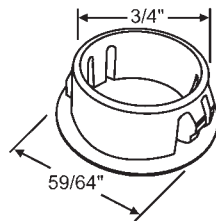

Part #	Color
85-1125B	Black
85-1125W	White

**PGT**

### JAMB COVER

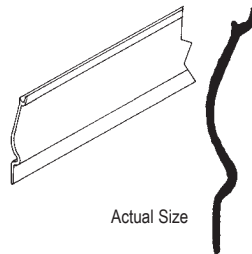

Part #	Color
85-702	Blue White
85-703	White
85-704	Charcoal Brown
85-702BG	Beige

Sold in 7' lengths, Minimum 140"

### TOOLS

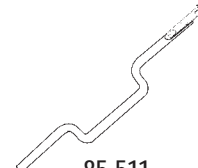

**85-511**  
Tilt Tensioning Tool. Used with 83 and 85 Series Balances



**85-515**  
Deluxe Tilt Tensioning Tool. Used with 83 and 85 Series Balances

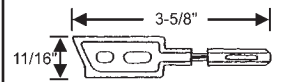

Part #	Color
900-18900W	White
900-18900BG	Beige

Fits Acro Windows

### TILT LATCHES - In Order by Hole Spacing

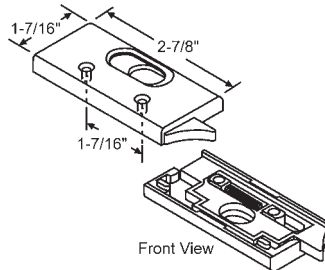
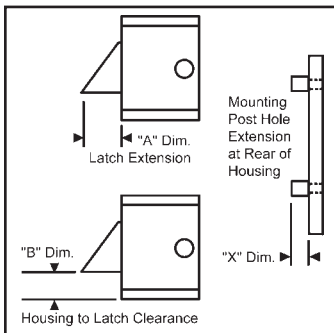

Part #	Hand	Color
900-20311LH	Shown	White
900-20311RH	Opposite	White

"A"	"B"	"X"
3/8"	21/32"	7/64"

**CERTAINTED**

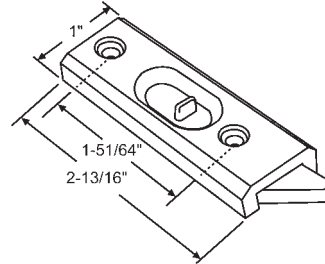

Part #	Hand	Color
85-773LH	Shown	White
85-773RH	Opposite	White

"A"	"B"	"X"
13/32"	3/16"	Flush w/Housing

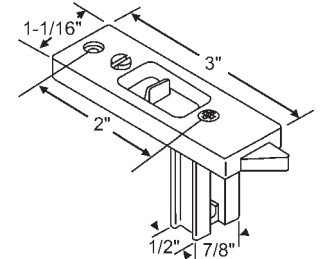

Part #	Color
900-16378WA	White
900-16378BRA	Brown

"A"	"B"	"X"
3/8"	7/32"	None

Sold in sets only (LH Shown).

**FIBERLUX**

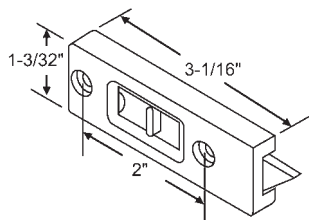

Part #	Color
85-618WA	White
85-618BA	Black
85-618BRA	Brown
85-618BGA	Beige

"A"	"B"	"X"
5/16"	1/4"	Flush w/Housing

Sold in sets only (LH Shown).

**FIBERLUX**

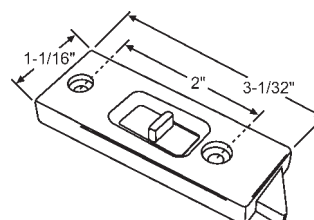

Part #	Hand	Color
85-737RW	Shown	White
85-737LW	Opposite	White

"A"	"B"	"X"
5/16"	3/32"	Flush w/Housing

# SASH SUPPORT SYSTEMS

## 85 SERIES BALANCE ACCESSORIES

### TILT LATCHES - In Order by Hole Spacing

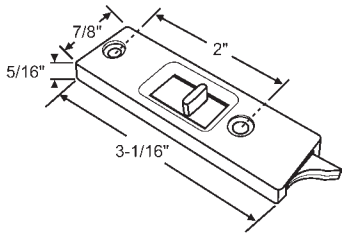

Part #	Color
85-887W	White

"A"	"B"	"X"
11/32"	3/16"	Flush w/Housing

Sold in sets only. LH Shown

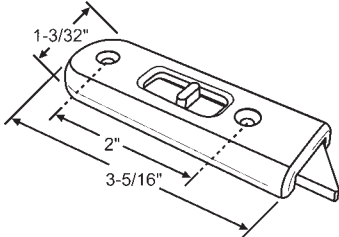

Part #	Color
85-817	White

"A"	"B"	"X"
7/16"	1/4"	Flush w/Housing

Sold in sets only  
**VINYLUME**

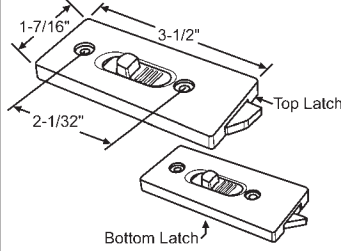

Part #	Color
85-726WH	White

Latch	"A"	"B"	"X"
Top	9/32"	15/32"	Flush w/Housing
Bottom	9/32"	11/16"	Flush w/Housing

Sold in sets only. LH Shown  
**KEYSTONE**

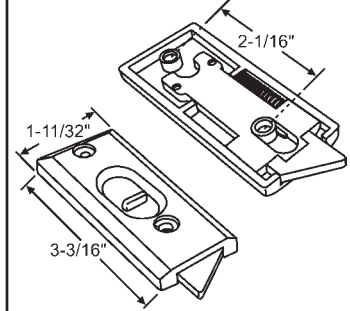

Part #	Color
900-16281WA	White

"A"	"B"	"X"
3/8"	5/16"	Flush w/Housing

Sold as set only.

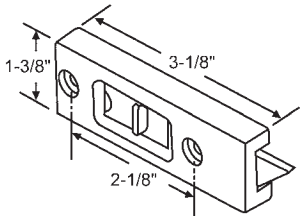

Part #	Hand	Color
85-528LHW	Shown	White
85-528RHW	Opposite	White
85-528LHB	Shown	Black
85-528RHB	Opposite	Black

"A"	"B"	"X"
11/16"	1/4"	Flush w/Housing

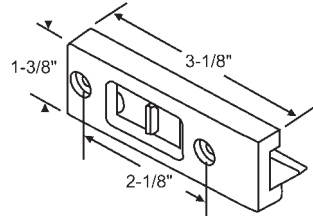

Part #	Hand	Color
85-529LHW	Shown	White
85-529RHW	Opposite	White
85-529LHB	Shown	Black
85-529RHB	Opposite	Black

"A"	"B"	"X"
11/16"	1/4"	1/8"

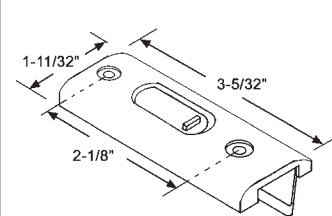

Part #	Color
900-12766WA	White
900-12766BA	Black

"A"	"B"	"X"
7/16"	1/4"	Flush w/Housing

Sold in sets only.

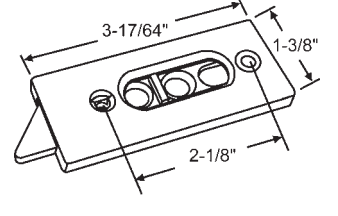

Part #	Color
900-16267A	White

"A"	"B"	"X"
1/2"	5/16"	Flush w/Housing

Sold in sets only.

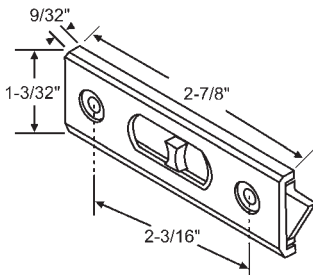

Part #	Color
900-19450WA	White

"A"	"B"	"X"
5/16"	5/16"	Flush w/Housing

Sold in sets only.

**GENERAL ALUMINUM**

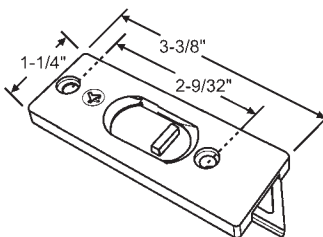

Part #	Hand	Color
900-11868RHW	Shown	White
900-11868LHW	Opposite	White

"A"	"B"	"X"
7/16"	5/16"	Flush w/Housing

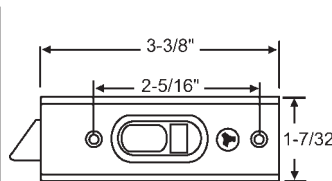

Part #	Color
85-616W	White
85-616B	Black

"A"	"B"	"X"
1/2"	1/4"	Flush w/Housing

Die Cast  
Reversible

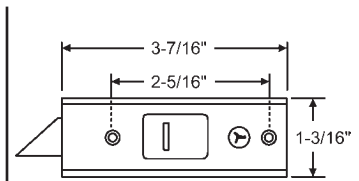

Part #	Hand	Color
85-578LW	Shown	White
85-578RW	Opposite	White
85-578LB	Shown	Black
85-578RB	Opposite	Black

"A"	"B"	"X"
7/16"	1/4"	Flush w/Housing

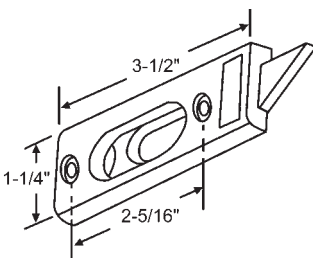

Part #	Color
85-533	Black
85-533WH	White

"A"	"B"	"X"
1/2"	5/16"	Flush w/Housing

Plastic  
Reversible

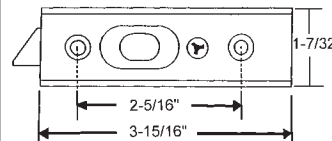

Part #	Color
85-617W	White
85-617B	Black

"A"	"B"	"X"
7/16"	9/32"	Flush w/Housing

Die Cast  
Reversible

## 85 SERIES BALANCE ACCESSORIES

### TILT LATCHES - In Order by Hole Spacing

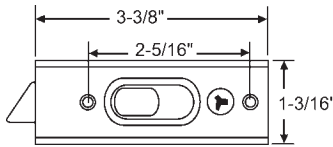

Part #	Color
900-11615B	Black
900-11615W	White

"A"	"B"	"X"
7/16"	5/16"	Flush w/Housing

Plastic  
Reversible

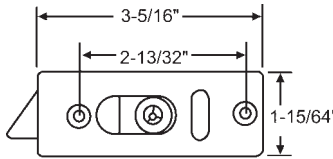

Part #	Hand	Color
85-532LHB	Shown	Black
85-532RHB	Opposite	Black
85-532LH	Shown	White
85-532RH	Opposite	White

"A"	"B"	"X"
7/16"	9/32"	Flush w/Housing

With lock. If needed, use tilt latch tool 59-6.  
**ACORN**

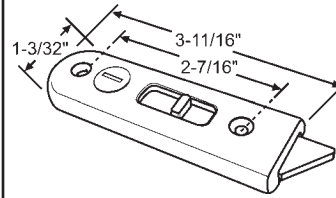

Part #	Hand	Color
85-6004RHW	Shown	White
85-6004LHW	Opposite	White

"A"	"B"	"X"
7/16"	1/4"	Flush w/Housing

**PGT**

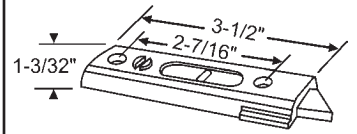

Part #	Color
900-16339BA	Black

"A"	"B"	"X"
1/2"	9/32"	Flush w/Housing

Sold in sets only.  
**PATRIOT**

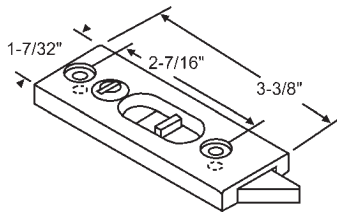

Part #	Color
900-19480WA	White

"A"	"B"	"X"
7/16"	5/16"	Flush w/Housing

Sold in sets only.  
**SEASONALL**

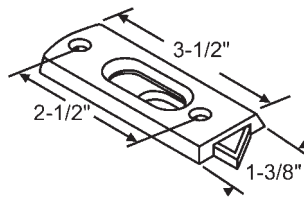

Part #	Color
85-736	White

"A"	"B"	"X"
13/32"	9/32"	1/8"

Universal

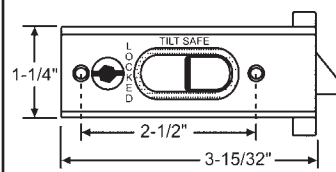

Part #	Color
85-719MB	Black
85-719MW	White

"A"	"B"	"X"
3/8"	3/8"	Flush w/Housing

Metal Housing w/Plastic Latch  
Reversible  
**SEASONALL**

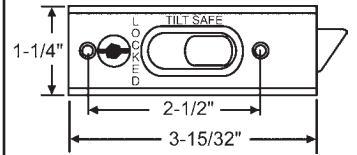

Part #	Color
85-619PW	White

"A"	"B"	"X"
13/32"	5/16"	Flush w/Housing

Plastic Assembly  
Reversible  
**SEASONALL**

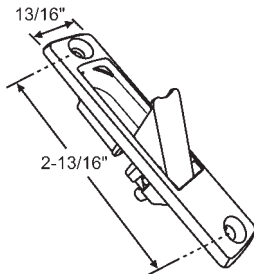

Part #	Color
85-5033A	Driftwood
85-5033WA	White

Sash Tilt Latch Kit. Kit Includes LH and  
RH Tilt Latches w/Screws  
**PEACHTREE**

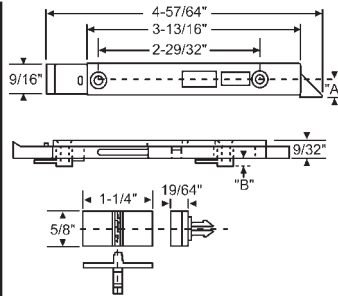

Part #	Hand	"A"	"B"
900-19869A	Shown	19/64"	3/32"
900-19875A	Shown	11/32"	9/64"

Sold in sets only (RH, LH).  
White. Includes thumb button  
**SPECTUS**

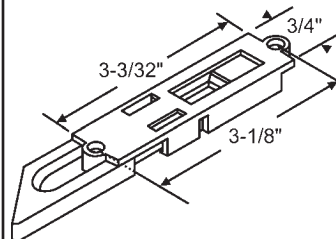

Part #	Color
900-19847WA	White

Sold in sets only.  
Used with 900-19448 thumb button.

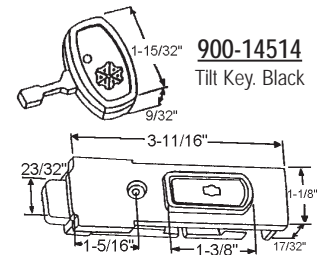

Part #	Color
900-12808BA	Black

"A"	"B"	"X"
1/4"	5/16"	Flush w/Housing

Sold in sets only.  
**AMACOR**

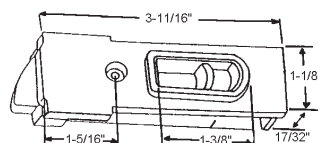

Part #	Color
900-15683BA	Black

"A"	"B"	"X"
9/32"	3/16"	Flush w/Housing

Sold in sets only.  
**AMACOR**

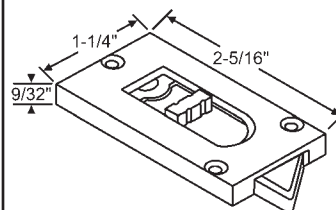

Part #	Color
900-20221WA	White

"A"	"B"	"X"
1/4"	5/16"	Flush w/Housing

Reversible

# SASH SUPPORT SYSTEMS

## 85 SERIES BALANCE ACCESSORIES

### TILT LATCHES - In Order by Hole Spacing

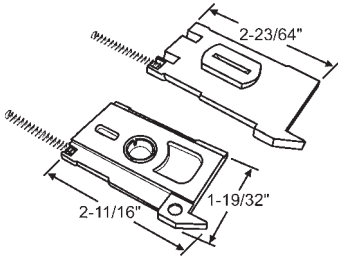

Part #	Color
85-1030WA	White

"A"	"B"	"X"
5/16"	1-3/8"	Flush w/Housing

Set (Includes RH & LH) RH Shown

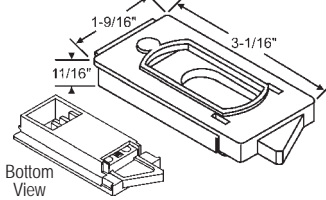

Part #	Color
900-19433WA	White
900-19433BA	Black
900-19433BGA	Beige

"A"	"B"	"X"
7/16"	3/8"	Slides onto Extrusion

Sold in sets only.

**MANNIX & ECKER**

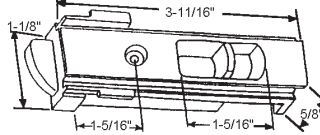

Part #	Color
900-15486BA	Black

"A"	"B"	"X"
1/4"	3/16"	Flush w/Housing

Sold in sets only.

**AMACOR**

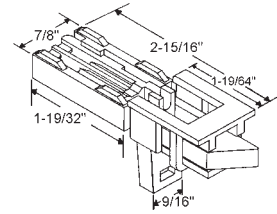

Part #	Color
900-16976WA	White

"A"	"B"	"X"
7/16"	5/16"	None

Sold in sets only.

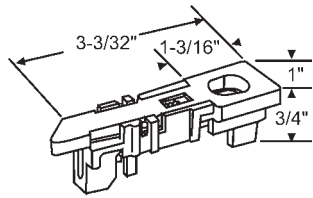

Part #	Color
900-17651A	White

Sold in sets only.

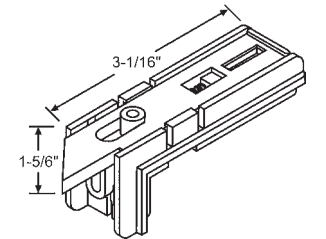

Part #	Hand
900-19178	Shown
900-19177	Opposite

White

**MAYNARD/CHELSEA**

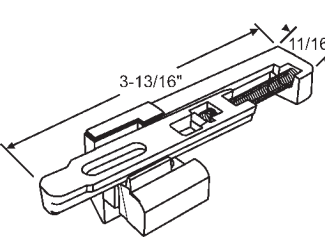

### 85-5034A

Sash Tilt Latch Housing Kit. Driftwood. Kit Includes LH and RH Housings w/ Screws

**PEACHTREE**

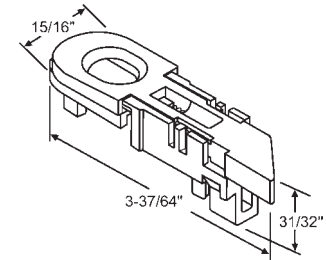

Part #	Hand
85-775RH	Shown
85-775LH	Opposite

**DOVE/SILVERLINE**

### SNAP-IN TILT LATCHES

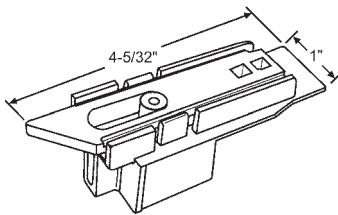

Part #	Color
85-827WA	White

Sold in sets only.

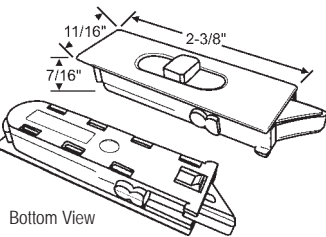

Part #	Hand	Color
85-932LH	Shown	White
85-932RH	Opposite	White

"A"	"B"	"X"
5/16"	1/8"	None

**SILVER LINE**

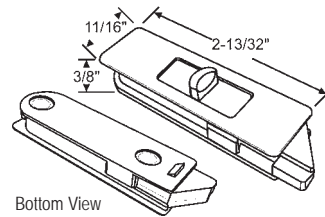

Part #	Color
85-963WA	Blue White

"A"	Nose Size
5/16"	3/8"

Sold in Sets Only. RH Shown

**SILVER LINE**

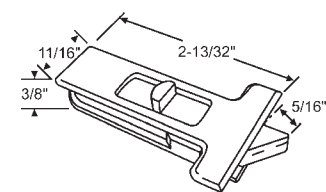

Width of Wings 1-7/16"

### 85-900WA

White  
Set (1 RH/ 1 LH) LH Shown

**SILVERLINE**

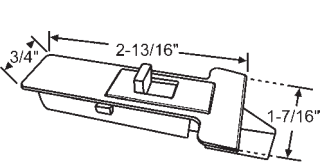

Part #	Color
85-962WA	White

"A"	"B"	"X"
3/8"	7/16"	None

Sold in Sets Only. RH Shown

**SILVER LINE**

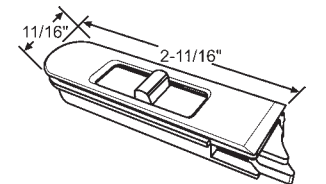

Part #	Hand	Color
85-6005RHW	Shown	White
85-6005LHW	Opposite	White

"A"	"B"	"X"
11/32"	3/32"	None

**PGT**

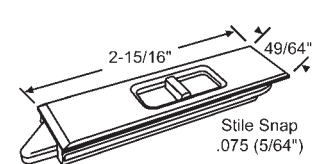

Part #	Color
85-853WA	White

"A"	"B"
3/8"	5/32"

Sold in sets only.

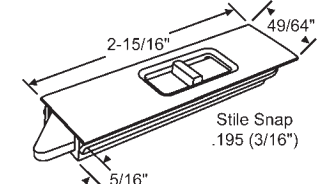

Part #	Color
85-892WA	White

"A"	"B"
3/8"	5/32"

Sold in sets only.

## 85 SERIES BALANCE ACCESSORIES

### SNAP-IN TILT LATCHES

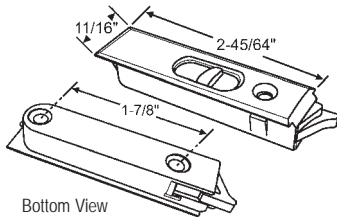

Bottom View

Part #	Hand	Color
85-940LW	Shown	White
85-940RW	Opposite	White
85-940LWG	Shown	Beige
85-940RWG	Opposite	Beige

"A"	"B"	"X"
5/16"	1/16"	None

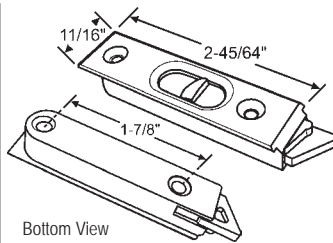

Bottom View

Part #	Hand	Color
85-939LW	Shown	White
85-939RW	Opposite	White

"A"	"B"	"X"
7/16"	Flush w/Housing	None

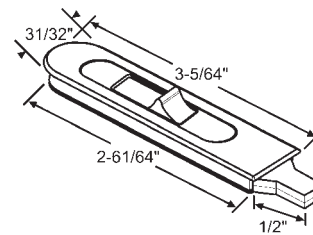

Part #	Color
85-905-3	White

Non-Handed

**POZZI/JELD-WEN**

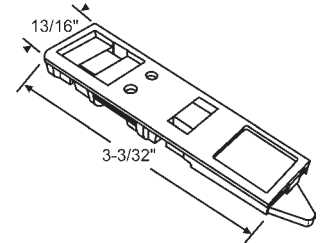

Part #	Color
85-809WA	White

"A"	"B"	"X"
7/16"	1/16"	None

Sold in Sets

### ADDITIONAL SNAP-IN TILT LATCHES - In Order by Style

#### Standard Nose Chart

Our Part #	Hand	Color	Nose Size	Stile Snap Size	Actuator
85-910A	Set	Dark Brown	1/4"	5/64"	Standard
900-21229A	Set	Blue White	1/4"	3/16"	Standard
85-819WA	Set	Blue White	9/32"	3/32"	Standard
85-1054WA	Set	White	9/32"	3/8"	Standard
900-19498WA	Set	White	3/8"	3/16"	Deluxe

#### Scalloped Nose Chart

Our Part #	Hand	Color	Nose Size	Stile Snap Size	Actuator
900-19496RH	Right	Dark Brown	3/8"	3/32"	Standard
900-19496LH	Left	Dark Brown	3/8"	3/32"	Standard

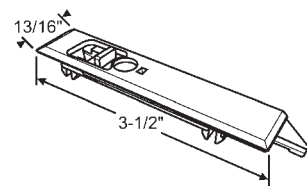

Part #	Color
85-881WA	White

"A"	"B"	"X"
5/16"	5/16"	5/16"

Sold in sets only. RH Shown

**CERTAINTED**

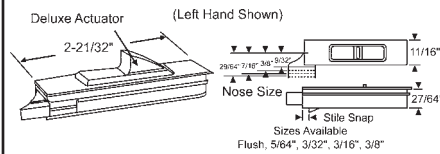
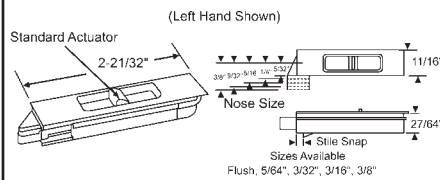

### SASH PLUNGER

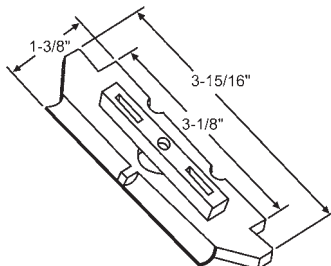

#### 900-8600

Black with springs.  
Used with pivot bar 900-8599.

**TRACO**

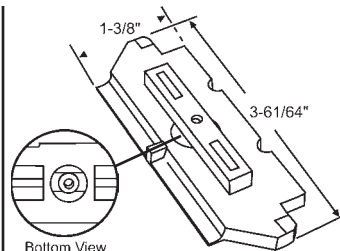

#### 900-8600MOD

Black with springs. Modified to accept tamper proof screw. Screw #20-468

**TRACO**

### TILT LATCH INSERT

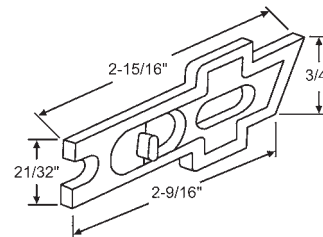

Part #	Hand	Color
85-527RHW	Opposite	White
85-527LHW	Shown	White
85-527RH	Opposite	Black
85-527LH	Shown	Black

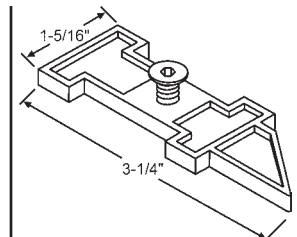

#### 900-16316

Black with screw.  
Screw only: 900-16316S

**PEERLESS**

### TILT SLIDE BUTTONS

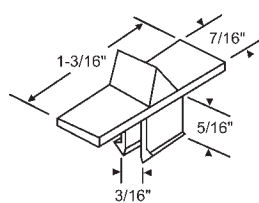

#### 900-15551B

Black  
**AMACOR**

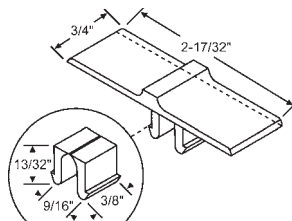

Part #	Color
900-19037	White

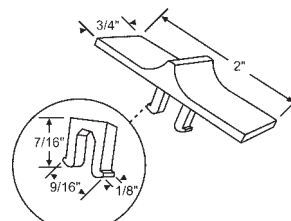

Part #	Color
900-19038	White
900-19038BE	Beige

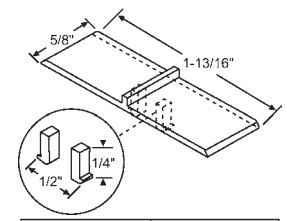

Part #	Color
900-19015	White
900-19015BR	Brown
900-19015BG	Beige

# SASH SUPPORT SYSTEMS

## 85 SERIES BALANCE ACCESSORIES

### TILT SLIDE BUTTONS

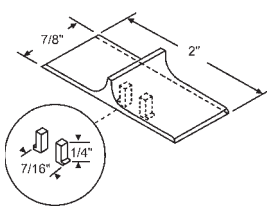

Part #	Color
900-14340BR	Brown
900-14340	White

**GREAT LAKES**

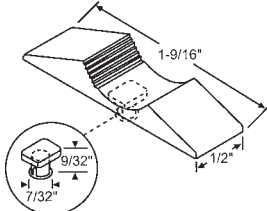

Part #	Color
900-21219W	White
900-21219BZ	Bronze
900-21219	Beige

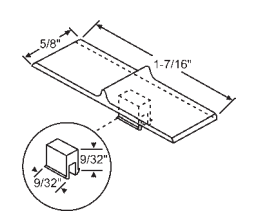

Part #	Color
900-19744	Bronze
900-19744BG	Beige

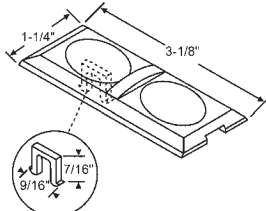

Part #	Color
85-729BR	Brown

**REYNOLDS**

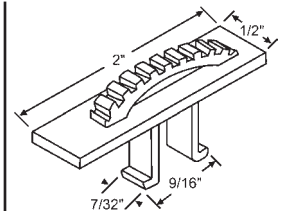

**900-19448**  
White

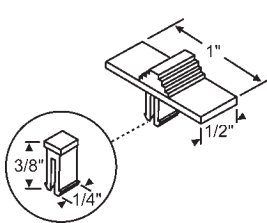

Part #	Color
85-620BR	Brown
85-620BG	Beige

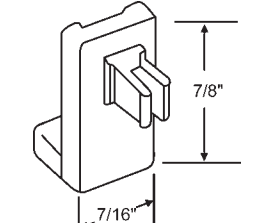

Part #	Color
85-508	White
85-508B	Black
85-508BG	Beige

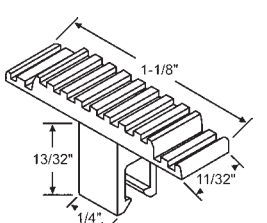

**85-552BG**  
Beige  
**ACRO/SLOCOMB**

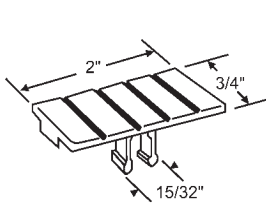

**900-18706**  
White  
**VINYL BUILDING PRODUCTS**

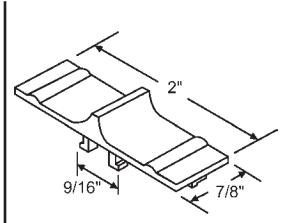

**900-19179**  
White  
**HARVEY**

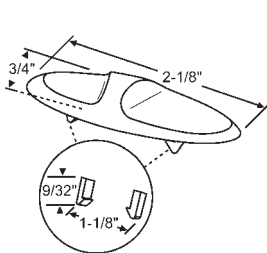

**85-1033W**  
White

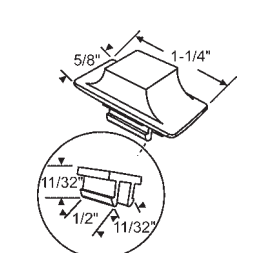

**85-834**  
White

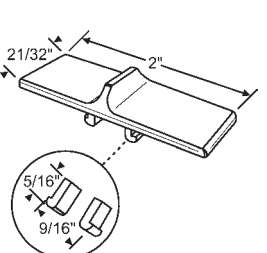

**85-842**  
White

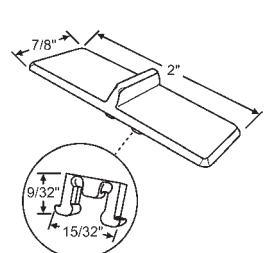

**85-760**  
White

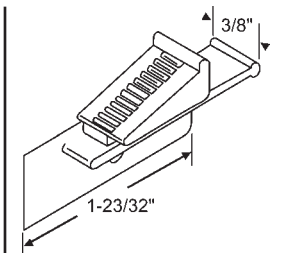

Part #	Color
85-553	White
85-553B	Black

### NYLON GUIDE

### TILT LATCH CAP

### INSERT ANGLE

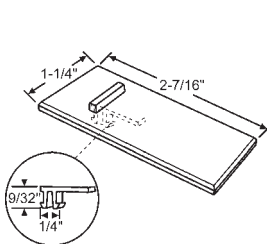

**85-1083W**  
White

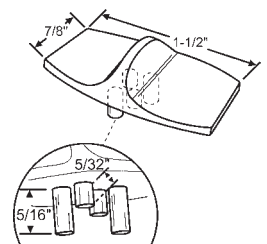

**85-882W**  
White  
For 85-881WA

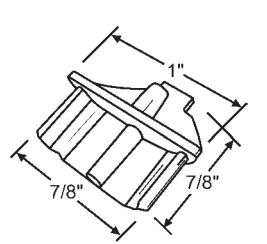

Part #	Color
85-1057B	Black
85-1057W	White

**TRACO**

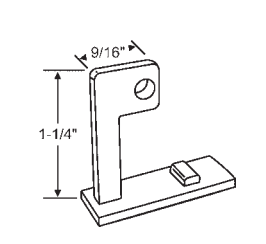

Part #	Color
900-6765	White
900-6765B	Black

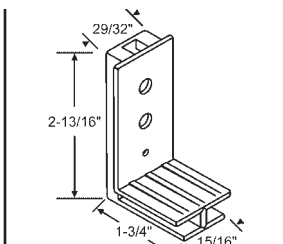

**900-18899**  
White, Plastic  
**ACRO/SLOCOMB**

## 88L SERIES ULTRALIFT 43/64" HEAVY DUTY TUBE BALANCE

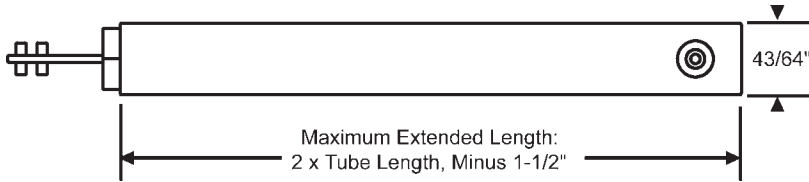

The heavy duty Ultralift is not only an excellent product for counterbalancing windows from 10lbs. to 100 lbs.; it also reduces the manual force required to open and close windows by 50%. Standard balances only provide about 40% of the sash weight while the Ultralift lifts 70% of the sash weight. This makes the Ultralift an excellent product to use in nursing homes, schools and windows that are difficult to access. These balances can be used in sashes from 10 lbs. to 100 lbs. in weight.

### Here are the facts:

- Lifts 70% of sash weight vs. AAMA'S 40% minimum.
- Provides even power across full range of sash travel.
- Usable with both tilt and non-tilt windows.
- Adjustable on site by +2 lbs.

- Fits most C-20 and HC-40 AAMA grade single and double hung windows.
- Fits most large architectural wood windows.
- Combines spiral and extension spring technology.
- Covered by a 5-year warranty.
- Custom made for specific sash weights.

### Installing Balance in Tilt Windows

1. Mount the balance to the outer frame with a screw (See Figure 1). Do not overtighten screw.
2. Raise the pivot shoe in the jamb channel and insert the balance rod into the shoe rod slot (See Figure 2).
3. Install the sash.

### Installing Balance in Non-Tilt Windows

1. Mount balance to outside frame with screw (See Figure 1). Do not overtighten screw.
2. With top stops removed, raise the sash so that the sash brackets protrude below bottom rail. Pull bracket around sash corner with installation tool (See Figure 3).
3. Attach sash bracket to bottom rail using a minimum of two screws per bracket (See Figure 4).

### ORDERING INFORMATION

1. Supply information stamped on balance.
2. First set of numbers represent the tube length of balance (actual tube length is 1/2" longer than number stamped on balance).
3. Second set of number represents the sash weight (balances are pre-tensioned to the exact weight of sash).
4. Specify color of the tube: Gray (standard), White, Black or Tan.

**Ordering Example:** Information stamped on balance is 18-24 lbs Ultralift. Order our 88L-18S24. You will receive gray tube.

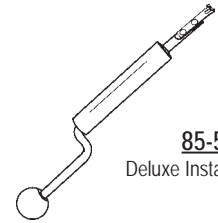

**85-515**  
Deluxe Installation Tool

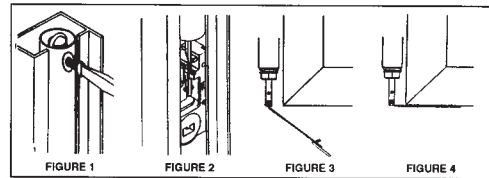

## 88L SERIES BALANCE ACCESSORIES

### PIVOT LOCK SHOES

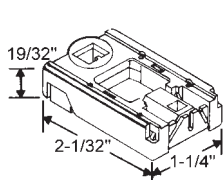

**85-505**  
No Longer Available  
Use: 85-517

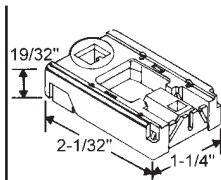

**85-517**  
Black Cam  
Cam Opening: 3/8" x 3/16"

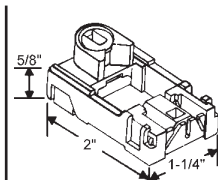

**85-518**  
Red Cam  
Cam Opening: 3/8" x 3/16"  
**TRACO**

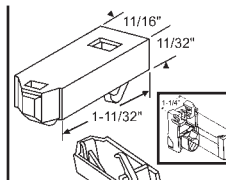

**85-606**  
Tamp-R-Lock. Snaps on to eliminate take out function.  
Black

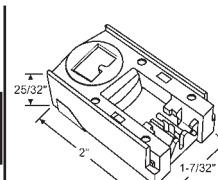

**85-5045**

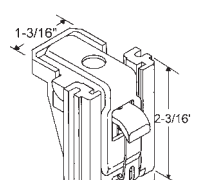

**88-503**  
Carrier

### PIVOT BARS

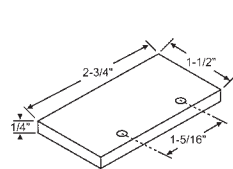

**900-21112**  
Black. Anodized Aluminum

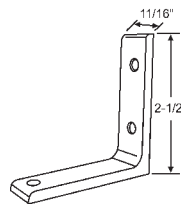

**88-700**  
Anodized Aluminum Angle Stop - Black

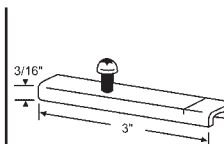

**85-501**  
Metal  
**NORANDEX**

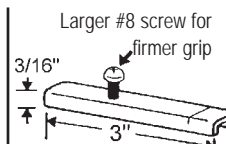

Larger #8 screw for firmer grip  
**88-505**  
Special heat treated for added strength

### BRACKETS

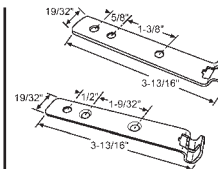

Part #	Description
88-500	Standard Holes for Non-Tilt
88-501	Countersunk Holes

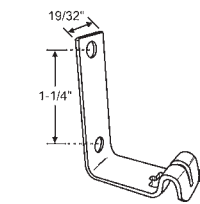

**88-543**  
Stainless Steel.  
Countersunk Holes

### PIVOT LOCK SHOE ADAPTER

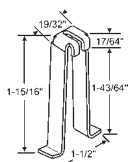

For use with 88L heavy duty balances. Not sold separately. Must be purchased with Ultra Lift Balances.  
**88-508**  
Stainless Steel

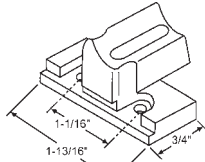

Part #	Hand
900-20214LH	Shown
900-20214RH	Opposite

Cast Aluminum

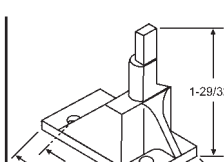

**900-13070A**  
Sold in sets only.

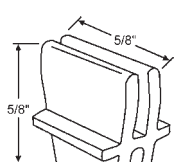

**88-519**  
For UltraLift  
**TRACO**

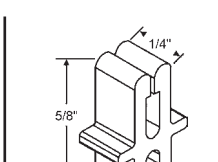

**88-540**  
For Ultra Lift  
**TRACO**

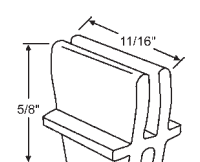

**88-542**  
For Ultra Lift  
Blue

### TAMPER LOCKS

# SASH SUPPORT SYSTEMS

## 88L SERIES BALANCE ACCESSORIES

### GUIDE

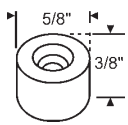

**62-658**

Heavy Duty Die Cast  
Face Guide

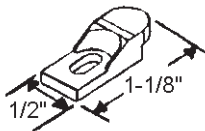

**900-12977**

**SWS**

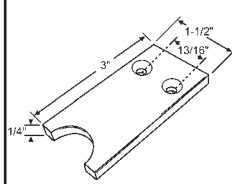

**88-604**

Black w/Countersunk Holes

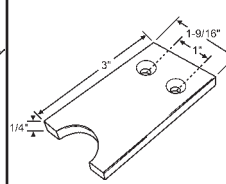

**88-605**

Black w/Countersunk Holes

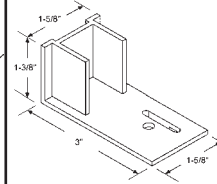

Part #	Hand
88-602RH	Shown
88-602LH	Opposite

Riverview 400S. Black

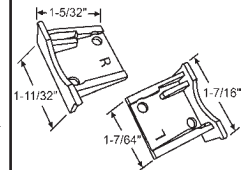

**88-612W**

White  
**PGT**

## 88LL & 88SL SERIES - 21/32" & 3/4" TUBE BALANCES



### Ordering Information

- Determine series 88LL (21/32" (.656) OD) or 88SL (3/4" (.750) OD) based on sash weight range required.
- Select pin option (1, 2, 3, 4, 5 or 6) from diagram shown.
- Determine tube length.
- Determine color (gray, black, white & tan).

### General Information

- Travel characteristics for these balances is 2x tube length minus 2".
- Choose the required pivot lock shoes or brackets from the balance accessory page.
- Proper tension is acquired by winding in a COUNTERCLOCKWISE direction.

Note: All accessories must be ordered separately.

Example: Sash weighing 92 lbs. and balance is 38" long with 2 pins 1/2" long and gray cover the part number is: 88SL90-438G

### 88LL Series Balance

#### 21/32" Diameter Plastic Tube Balance

Series	Tube Lengths	Weight Ranges	Bearing Color	Part Number
88LL	6" to 72"	20 to 29.5 lbs.	Red	88LL20-Pin Option + Tube Length + Tube Color
88LL	6" to 72"	30 to 39.5 lbs.	Blue	88LL30-Pin Option + Tube Length + Tube Color
88LL	6" to 72"	40 to 49.5 lbs.	Black	88LL40-Pin Option + Tube Length + Tube Color
88LL	6" to 72"	50 to 59.5 lbs.	White	88LL50-Pin Option + Tube Length + Tube Color
88LL	6" to 72"	60 to 69.5 lbs.	Yellow	88LL60-Pin Option + Tube Length + Tube Color
88LL	6" to 72"	70 to 79.5 lbs.	Yellow	88LL70-Pin Option + Tube Length + Tube Color
88LL	6" to 72"	80 to 89.5 lbs.	Yellow	88LL80-Pin Option + Tube Length + Tube Color
88LL	15" to 75"	90 to 99.5 lbs.	Yellow	88LL90-Pin Option + Tube Length + Tube Color

### 88SL Series Balance

#### 3/4" Diameter Plastic Tube Balance

Series	Tube Lengths	Weight Ranges	Part Number
88SL	20" to 74"	60 to 69.5 lbs.	88SL60-Pin Option + Tube Length + Tube Color
88SL	20" to 74"	70 to 79.5 lbs.	88SL70-Pin Option + Tube Length + Tube Color
88SL	20" to 74"	80 to 89.5 lbs.	88SL80-Pin Option + Tube Length + Tube Color
88SL	20" to 74"	90 to 99.5 lbs.	88SL90-Pin Option + Tube Length + Tube Color
88SL	20" to 74"	100 to 109.5 lbs.	88SL100-Pin Option + Tube Length + Tube Color
88SL	20" to 74"	110 to 119.5 lbs.	88SL110-Pin Option + Tube Length + Tube Color
88SL	20" to 74"	120 to 129.5 lbs.	88SL120-Pin Option + Tube Length + Tube Color

### Balance Tilt Pin Options

Note: 1, 2 and 3 can also be used on non-tilt systems.

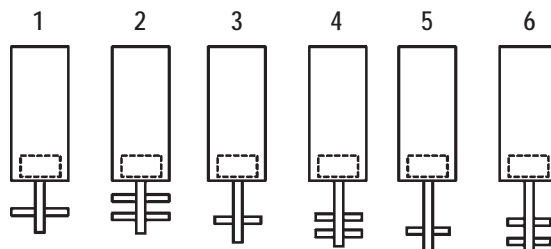

One 3/4" Pin Two 3/4" Pins One 1/2" Pin Two 1/2" Pins One 1/4" Pin Two 1/4" Pins



## 89 SERIES WINDOW BALANCES

### CARADCO C-100 Balances Exclusively for Wood Windows



#### ORDERING INFORMATION

1. Measure the length of the plastic tube; do not include any of the plastic bracket end pieces.
2. Determine color of dye on the spring end.
3. Select corresponding part number from the chart below and order accordingly.

#### GENERAL INFORMATION

1. The tube lengths are available in only those sizes shown in chart below.
2. Tube color is always white.

Tube Length	Spring Color	Caradco Balance Code	Caradco Part #	Our Part #
13-1/2"	BROWN	A1	944814	89-30B
13-1/2"	GREEN	C2	944881	89-9T
13-1/2"	RED	D1	944906	89-14T
13-1/2"	YELLOW	B1	944847	89-1T
15-1/2"	BROWN	A2	944815	89-29B
15-1/2"	GREEN	C3	944882	89-10T
15-1/2"	RED	D2	944907	89-15T
15-1/2"	YELLOW	B3	944848	89-2T
17-1/2"	GREEN	C5	944821	89-3T
17-1/2"	GREEN	C6	944822	89-31B
17-1/2"	YELLOW	B4	944820	89-28B
19-1/2"	GREEN	C7	944850	89-4T
19-1/2"	GREEN	C8	944884	89-8T
19-1/2"	NONE	E5	944908	89-22T
19-1/2"	RED	D5	944878	89-17T
19-1/2"	YELLOW	B5	944817	89-27B
21-1/2"	GREEN	C10	944885	89-11T
21-1/2"	GREEN	C9	944851	89-5T
21-1/2"	NONE	E7	944880	89-35B
21-1/2"	RED	D6	944823	89-18T
21-1/2"	YELLOW	B6	944818	89-26B
23-1/2"	GREEN	C11	944852	89-6T
23-1/2"	NONE	E14	944829	89-21T
23-1/2"	NONE	E8	944825	89-20T
23-1/2"	RED	D8	944903	89-16T
23-1/2"	YELLOW	B7	944819	89-25B
27-1/2"	GREEN	C12	944877	89-23B
27-1/2"	NONE	E9	944883	89-13T
27-1/2"	RED	D9	944879	89-7T
30-1/2"	NONE	E13	944826	89-36B
30-1/2"	RED	D11	944824	89-32B
33-1/2"	RED	D12	922546	89-33B
35-1/2"	GREEN	C14	944900	89-24B
35-1/2"	RED	D14	944828	89-34B

To determine balance number you need, find part numbers by glass size and then select top or bottom sash. Contact your account manager if not shown.

#### Glass Width

		Position	16"	20"	24"	28"	32"	36"	40"
14"	Top	----	89-1T	89-9T	89-9T	89-14T	89-14T	----	----
	Bottom	----	89-30B	89-1T	89-1T	89-9T	89-9T	----	----
16"	Top	89-29B	89-2T	89-10T	89-10T	89-15T	89-15T	89-15T	89-15T
	Bottom		89-29B	89-2T	89-2T	89-10T	89-10T	89-10T	89-10T
18"	Top	89-28B	89-3T	89-3T	89-3T	89-38	89-38	89-38	----
	Bottom		89-28B	89-28B	89-3T	89-3T	89-3T	89-3T	----
20"	Top	89-27B	89-4T	89-4T	89-4T	89-17T	89-17T	89-17T	89-22T
	Bottom		89-27B	89-4T	89-4T	89-4T	89-4T	89-4T	89-4T
22"	Top	89-26B	89-5T	89-5T	89-5T	89-18T	89-35B	89-19T	89-19T
	Bottom		89-26B	89-5T	89-5T	89-5T	89-5T	89-5T	89-18T
24"	Top	89-25B	89-6T	89-16T	89-16T	89-20T	89-20T	89-20T	89-20T
	Bottom		89-25B	89-6T	89-6T	89-6T	89-16T	89-16T	89-16T
28"	Top	89-23B	89-7T	89-7T	89-13T	89-13T	89-13T	89-13T	89-13T
	Bottom		89-23B	89-23B	89-7T	89-7T	89-7T	89-7T	89-7T
* 22/34"	Top	----	----	----	89-5T	89-18T	E7-89-18T	----	----
	Bottom	----	----	----	89-7T	89-32B	89-33B	----	----
* 24/36"	Top	----	89-6T	89-16T	89-16T	89-20T	89-20T	89-20T	89-20T
	Bottom		89-24B	89-24B	89-34B	89-34B	89-34B	89-34B	89-36B
** 44/16"	-	----	----	----	----	89-10T	89-10T	----	----
34"	Top	----	----	----	89-20T	89-20T	89-20T	----	----
	Bottom	----	----	----	89-33B	89-33B	89-33B	----	----
36"	Top	----	89-8T	----	----	89-21T	89-21T	----	----
	Bottom	----	89-24B	----	----	89-33B	89-34B	----	----

\*for oriel window

\*\*for reverse oriel or cottage window

Note: Spring strength from lightest to strongest is brown, yellow, green, red, none.

Note: Purple and black springs can be special ordered. Please contact your account manager.

# SASH SUPPORT SYSTEMS

## WINDOW BALANCE RIVET/TENSION TOOLS

For Channel and Tube Balances. "A Must for Repair and Assembly of Balance Brackets"  
 (Tube & Channel) Professional Results! Say Good-bye to Hammered Fingers!  
 FAST - EFFICIENT - COST EFFECTIVE

### RIVET CRIMPING PLIERS

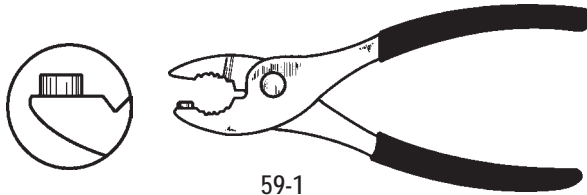

**59-1**

Adjusts to accommodate both tube and channel balances.

### RIVET REMOVAL PLIERS

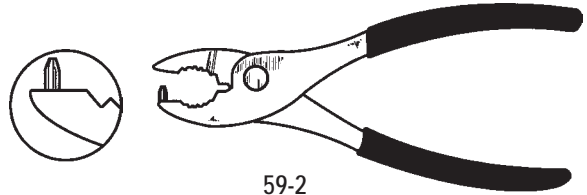

**59-2**



**59-3**

Replacement pin for rivet removal pliers

For tube balances, simply line up pin with peened rivet and squeeze. Rivet will be pushed out.  
 For channel balances, grind or file rivet flush and then squeeze to remove rivet.

### BALANCE EXTENDER TOOL

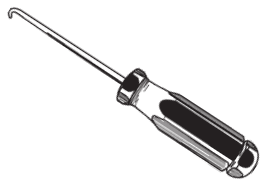

**59-42**

### BALANCE TENSIONING TOOLS

(Used with 70, 72, 74, 75, and 76 Series Balances)

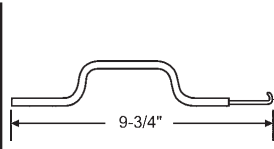

**70-515**

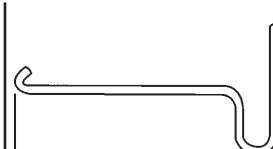

**70-516**

(Used with 83 and 85 Series Balances)

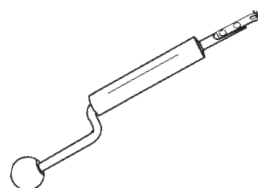

**85-515**

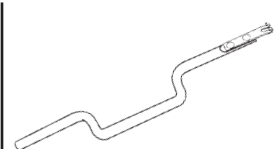

**85-511**

### JAMB STRETCHER

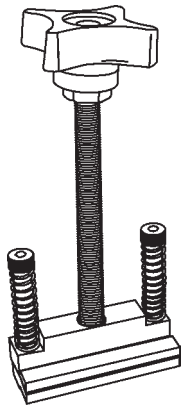

## JAMB STRETCHER

**59-52 (2 Piece Set)**

The Jamb Stretcher enables you to spread a vinyl jamb pocket in order to replace balances, shoes or other components without the need to cut into the jamb or melt the vinyl with a hot air gun.

Replace components in a fraction of the time compared to other methods.

This is an excellent tool for factory use or field repair! Designed for use in Vinyl Jamb only!

### 3 Easy Steps:



1. Position one spreader below and one spreader above the item to be removed.

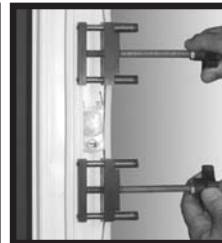

2. Turn knobs clockwise by hand or with a hex bit drill gun to spread jamb.

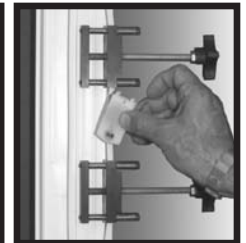

3. Remove/replace components.

### BALANCE INSTALLATION TOOL

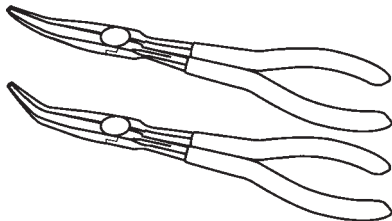

**59-7 (2 Piece Set)**

Long Reach Needle Pliers Set  
 2 piece 11" 20° offset & 45° angle

- Reach areas too tight for standard pliers
- Made from drop-forged, heat-treated steel

### ALUM-A-LUB LUBRICATING CLEANER

**59-5**

Alum-A-Lub Cleaner is the "All Purpose" lubricating cleaner that can be used on all products that stick or squeak. Alum-A-Lub assures ease of operation and a "Like New" appearance for metal windows, doors, locks, hinges, cabinets and more. Simply spray and wipe away dirt, grime and gummy residue left by other lubricants. A must for your shop, workroom, home, maintenance department or garage. Sold individually and in cases of 12.



Net Weight 9.4oz.

### L.C. WAX ALUMASLICK ALUMINUM LUBRICANT

**59-50**

"L.C. Wax" Alumaslick Aluminum Lubricant & Liquid Masking cleans and lubricates aluminum better than anything. Quick penetration/release and long lasting lubrication. Cleans corrosion and tarnish; protects from salt corrosion; reduces wear; stops squeaks, bumps, klunks, clinks. Sold individually and in cases of 12.



Net Weight 11oz.

## TAPE BALANCES

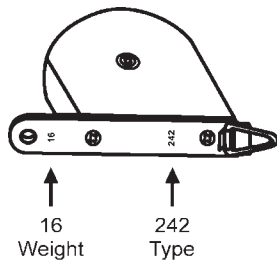

16  
Weight      242  
Type

Overhead Style - FT

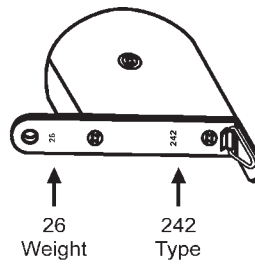

26  
Weight      242  
Type

Overhead Style - AT

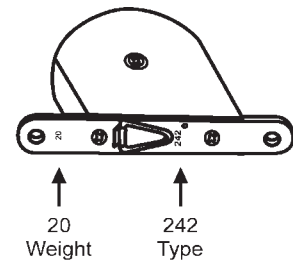

20  
Weight      242  
Type

Side Style - S

### Ordering Information

1. Identify Style: FT - AT - S
2. Identify Type: 242 - 150 - 154 (Type number will be stamped on face plate).
3. Determine weight. (Number is stamped on face plate.)
4. Select our corresponding part number from chart below.

### General Information

1. Type 242 for maximum sash weight 26 lbs., tape length 39".  
Type 150 for maximum sash weight 35 lbs., tape length 50".  
Type 154 for maximum sash weight 50 lbs., tape length 50".
2. Balance size is governed by the weight of sash and length of tape required. All balance weights are per pair of balances.
3. Tapes for special weight and lengths are available. Consult your sales representative.
4. All tape balances are custom made and, therefore, they are non-returnable.

### Overhead Style - FT

LBS.	TYPE 242 Part #	TYPE 150* Part #	TYPE 154 Part #
4	96-1	-	-
6	96-2	96-37	-
8	96-3	96-38	-
10	96-4	96-39	-
12	96-5	96-40	-
14	96-6	96-41	-
16	96-7	96-42	-
18	96-8	96-43	-
20	96-9	96-44	96-73
22	96-10	96-45	96-74
24	96-11	96-156	96-75
26	96-12	96-46	96-76
28	-	96-47	96-77
30	-	-	96-78
32	-	96-48	96-79
34	-	-	96-80
36	-	96-154	96-81
38	-	96-155	96-82
40	-	-	96-83

### Overhead Style - AT

LBS.	TYPE 242 Part #	TYPE 150* Part #	TYPE 154 Part #
4	96-13	-	-
6	96-14	96-49	-
8	96-15	96-50	-
10	96-16	96-51	-
12	96-17	96-52	-
14	96-18	96-53	-
16	96-19	96-54	-
18	96-20	96-55	-
20	96-21	96-56	96-84
22	96-22	96-57	96-85
24	96-23	-	96-86
26	96-24	96-58	96-87
28	-	96-59	96-88
30	-	-	96-89
32	-	96-60	96-90
34	-	-	96-91
36	-	-	96-92
38	-	-	96-93
40	-	-	96-94

### Side Style - S

LBS.	TYPE 242 Part #	TYPE 150* Part #	TYPE 154 Part #
4	96-25	-	-
6	96-26	96-61	-
8	96-27	96-62	-
10	96-28	96-63	-
12	96-29	96-64	-
14	96-30	96-65	-
16	96-31	96-66	-
18	96-32	96-67	-
20	96-33	96-68	96-95
22	96-34	96-69	96-96
24	96-35	-	96-97
26	96-36	96-70	96-98
28	-	96-71	96-99
30	-	-	96-100
32	-	96-72	96-101
34	-	-	96-102
36	-	-	96-103
38	-	-	96-104
40	-	-	96-105

\* Note: Type 150 adjustable to 3 lbs. plus or minus weight specified

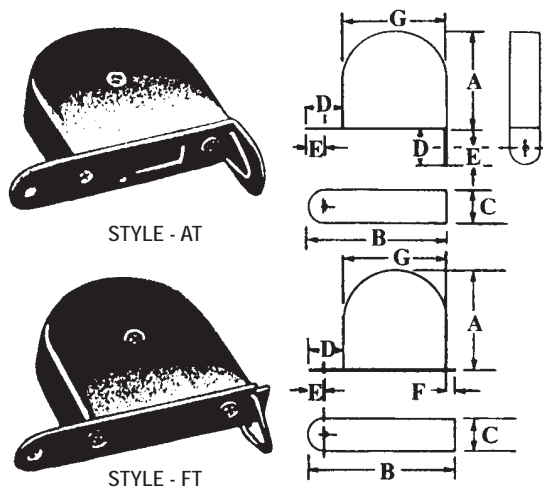

### TAPE BALANCE TECHNICAL INFORMATION

Size	A	B	C	D	E	G
242AT	3"	4-5/16"	7/8"	1-5/16"	5/16"	3"
150AT	3-3/8"	4-11/16"	1-1/8"	1-5/16"	3/8"	3-3/8"
154AT	3-5/16"	5-5/32"	1-1/4"	1-17/32"	15/32"	3-15/16"
242S	3"	5-5/8"	7/8"	1-5/16"	5/16"	3"
150S	3-3/8"	6"	1-1/8"	1-5/16"	3/8"	3-3/8"
154S	3-15/16"	7"	1-1/4"	1-13/32"	15/32"	3-15/16"
242FT	3"	4-11/16"	7/8"	1-5/16"	3/8"	3"
150FT	3-3/8"	5-1/8"	1"	1-5/16"	3/8"	3-3/8"
154FT	3-15/16"	5-13/16"	1-1/4"	1-17/32"	11/32"	3-15/16"

WGT. of Sash	4-26 lbs.	4-35 lbs.	20-50 lbs.
Balance Size	242	150	154
*Standard Tape Length	39"	50"	50"

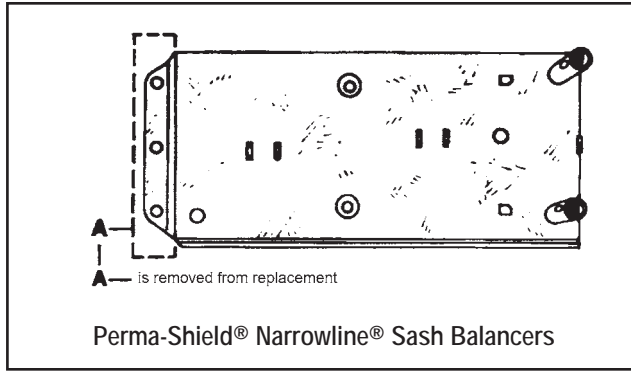

CAN BE USED TO REPLACE BALANCERS #	OUR PART NUMBER	USED TO REPLACE SERVICE BALANCERS #	OUR PART NUMBER
331, 319, 325	750-1626012	NOTE: Use the following service balancers on 56" high units or where limited travel is necessary.	
431, 419, 425, 431	750-1626018		
531, 519, 523, 527	750-1626024		
637, 623, 627, 631	750-1626029	R12/827	750-1626088
737, 725, 727, 731	750-1626034	L9/1327	750-1626090
837, 823, 827, 831	750-1626037	L10/1427	750-1626094
939, 927, 931, 937	750-1626043	R13/927	750-1626092
1031, 1027	750-1626044	L10/1827	750-1626055
1133, 1131	750-1626045	R14/1027	750-1626096
11L, 10SL	750-1626074	L12/1827	750-1626070
11R, 10SR	750-1626076	L1719/37	750-1626059
1231, 1226, 1227	750-1626048	R1737/19	750-1626061
1331	750-1626050	R18/1027	750-1626057
13L, 12SL	750-1626078	R18/1227	750-1626072
13R, 12SR	750-1626080		
1427, 1426	750-1626052		
1527	750-1626053		
16L, 14SL	750-1626082		
16R, 14SR	750-1626084		
L1427/31	750-1626066		
R1431/27	750-1626068		
L8/1227	750-1626086		

## OMEGA CONSTANT FORCE BALANCE SYSTEM

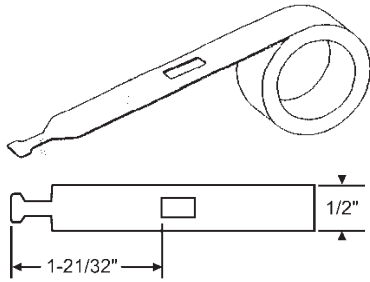

**STANDARD SPRING**

1. Determine correct sash weight (weights shown are per each side of sash)
2. Top sash should be overbalanced by selecting next highest balance.

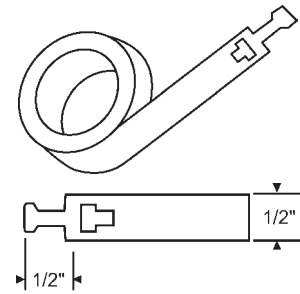

**EGRESS SPRING**

Spring Type	Sash/Spring Weight (per each side)	Coil Spring Length	Part Number
STANDARD	3.5LBS.	33"	900-21234
STANDARD	3.5LBS.	35"	96-BU-1
STANDARD	4.5LBS.	33"	900-19208
STANDARD	7.5LBS.	33"	900-21959
EGRESS	3.5LBS.	33"	900-21958
EGRESS	5LBS.	--	900-19205
EGRESS	7.5LBS.	33"	96-BU-5

### BRAKE SHOE

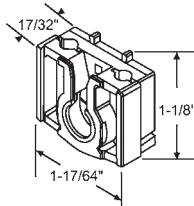

**900-19198**

### PIVOT BAR

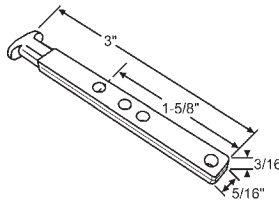

**900-22526**

### PIVOT BAR RETAINER

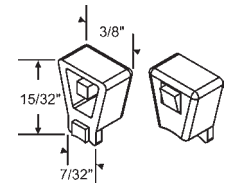

**900-22527**

## 96BT SERIES CONSTANT FORCE BALANCES

### TITAN

1" Pocket Size

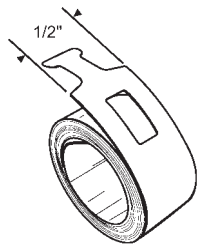

Spring

Our Part #	Weight
96BT-1	3.5 lbs.
96BT-2	4.5 lbs.

### BALANCE SUPPORTS

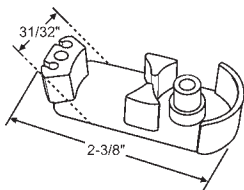

**96BT-5**  
Dual Support

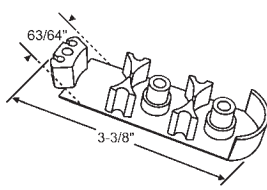

**96BT-6**  
Triple Support

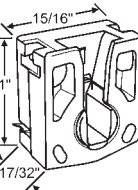

**96BT-3**  
Supa

### PIVOT RETAINER

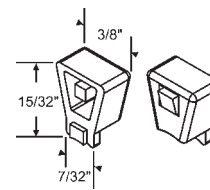

**900-22527**

### PIVOT BAR

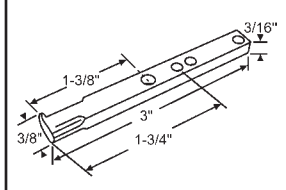

**62-545**  
Transit

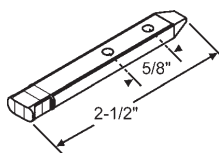

**62-550**  
T-Head

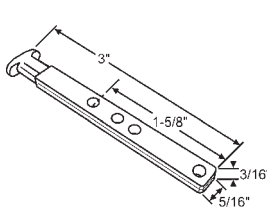

**900-22526**  
4-Hole

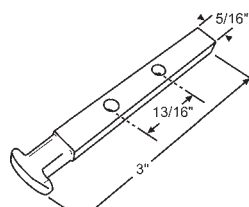

**62-551**  
Use: 62-553

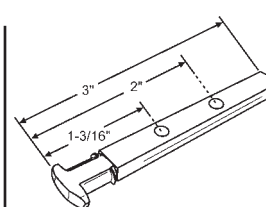

**62-553**

### BUMPER

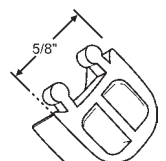

**96BT-4**

# SASH SUPPORT SYSTEMS

## 96BU SERIES CONSTANT FORCE BALANCES

**UNIVERSAL**  
1-1/4" Pocket Size

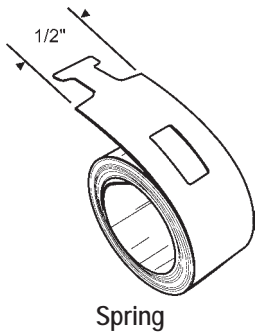

Our Part #	Weight
96BU-1	3.5 lbs.
96BU-2	4.5 lbs.
96BU-3	5.5 lbs.
96BU-4	6.5 lbs.
96BU-5	7.5 lbs.
96BU-10	9 lbs.
96BU-12	10 lbs.

## 96BU SERIES BALANCE SUPPORTS

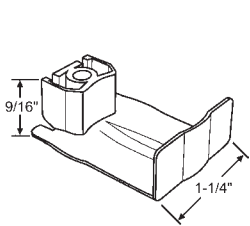

**96BU-6**  
Single Support

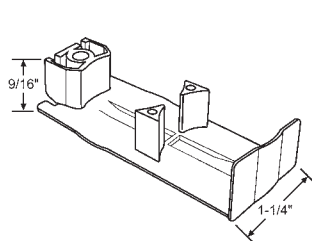

**96BU-7**  
Dual Support

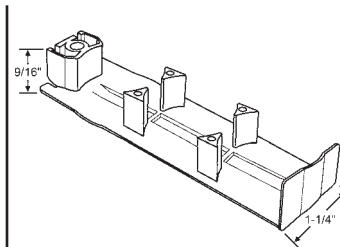

**96BU-8**  
Triple Support

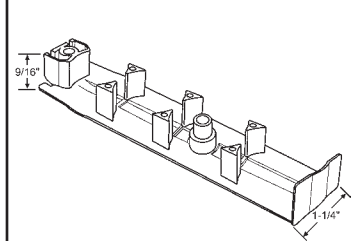

**96BU-9**  
Quad Support

## 96BU SERIES BALANCE ACCESSORIES

### LOCK BRAKE SHOE

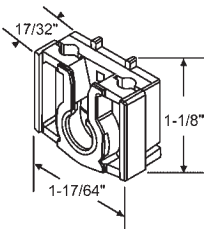

**900-19198**  
No Longer Available  
Use: 900-19198NS

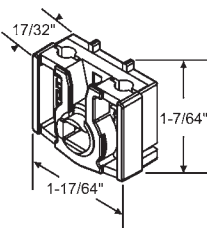

**900-19198NS**  
Spring Side  
Super Tough Nylon

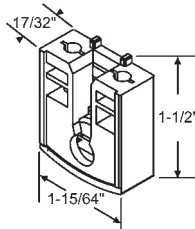

**96O-102**  
Back Locking Shoe

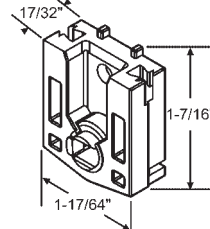

**96O-105**  
Spring Side

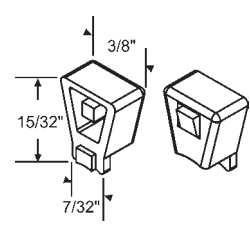

**900-22527**

### PIVOT RETAINER

### PIVOT BARS

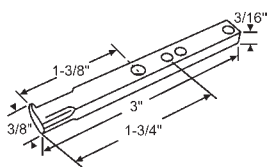

**62-545**  
Transit

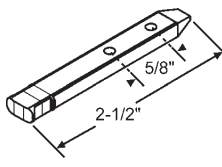

**62-550**  
T Head Pivot

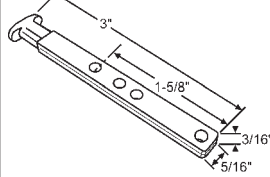

**900-22526**  
T-Pivot

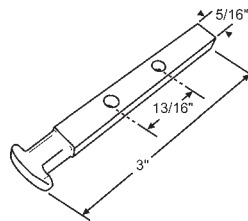

**62-551**  
Use: 62-553

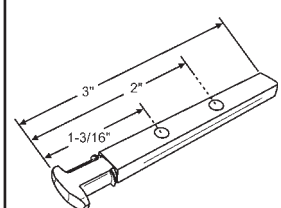

**62-553**

## 96-C SERIES COILED BALANCE SPRINGS

**CERTAINTED**

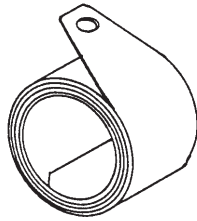

Short Tongue, 3/4" Wide

Number Stamped on Spring	Weight	Our Part #
263-S	3 lbs.	96-C263
334-S	4 lbs.	96-C334
335-S	5 lbs.	96-C335
405-S	5 lbs.	96-C405
336-S	6 lbs.	96-C336
406-S	6 lbs.	96-C406
407-S	7 lbs.	96-C407
408-S	8 lbs.	96-C408
409-S	9 lbs.	96-C409

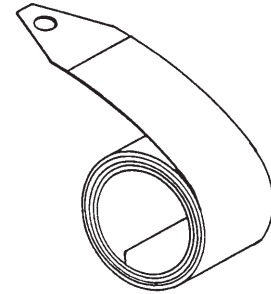

Long Tongue, 3/4" Wide

Number Stamped on Spring	Weight	Our Part #
405-L	5 lbs.	96-C405A
406-L	6 lbs.	96-C406A
407-L	7 lbs.	96-C407A
408-8	8 lbs.	96-C408A
409-8	9 lbs.	96-C409A

Note: Many other manufacturers' variations are available. Contact your account manager if you have a similar product. Samples may be required.

## 96-C SERIES BALANCE ACCESSORIES

### PIVOT LOCK SHOE

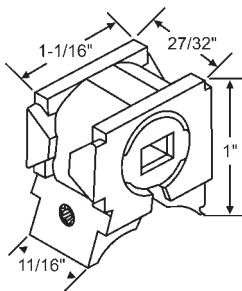

**Old Style**  
With Plastic Cam  
No Longer Available  
Use: 96-C1

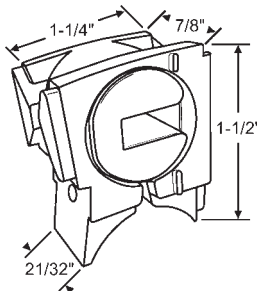

**96-C1 (New Style)**  
With Metal Cam  
Cam Opening: 19/64" x 3/16"  
**CERTAINTED**

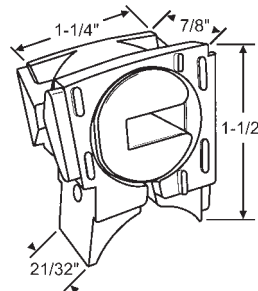

**96-C9**  
Nylon Body with Metal Cam and Alignment Nibs

### BALANCE SPRING COVERS

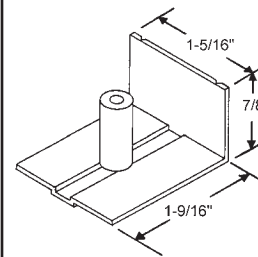

**96-C2**  
Drum Barrel Diameter: Outside 3/8" Inside 5/32". Wide  
**CERTAINTED**

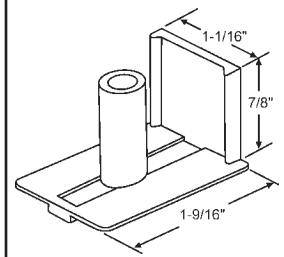

**96-C8**  
Drum Barrel Diameter: Outside 3/8" Inside 1/4". Narrow  
**CERTAINTED**

### BALANCE DRUM

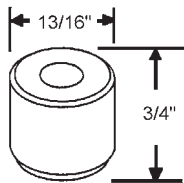

**96-C3**  
**CERTAINTED**

### PIVOT BAR

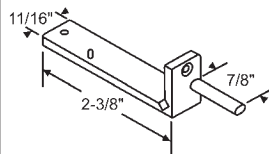

Part #	Hand
96-C7	Shown
96-C6	Opposite

Old Style. No Longer Available  
Use 96-C12 & 96-C11

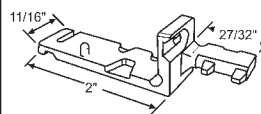

Part #	Hand
96-C12	Shown
96-C11	Opposite

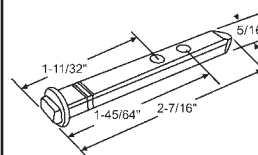

**85-864**

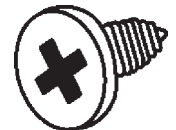

Part #	Color
20-240	Mill
20-240W	White

#8 x 3/8" Phillips Pan Head  
**CERTAINTED**

# SASH SUPPORT SYSTEMS

## 96CQ SERIES QUICK TILT CONSTANT FORCE BALANCE ACCESSORIES

The old style quick tilt constant force balance assemblies are no longer available. They are replaced with quick tilt NC assemblies. The old style quick tilt carriers use the "T" head pivot bars (see below), which will also need to be replaced when converting to the new style quick tilt NC system. The replacement assemblies take the round head pivot bar (see below). When ordering the replacement balance assemblies, identify the carrier size and the weight of the sash. Then, select the corresponding quick tilt NC balance assembly from chart shown on page 103.

### Old Style

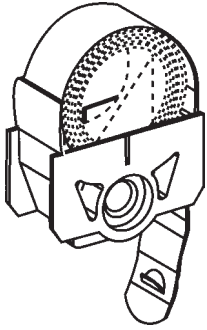

Tamper Lock

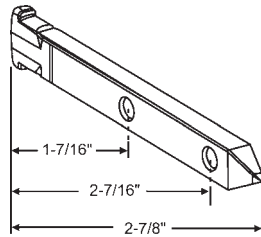
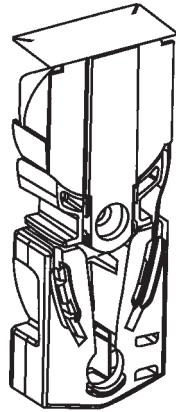

96CQ-20

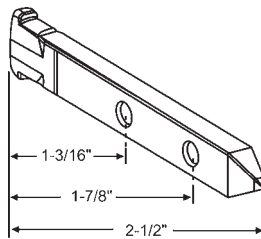

96CQ-22

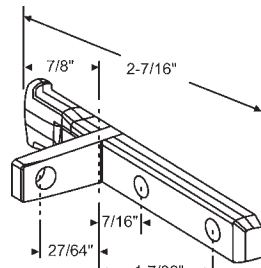

96CQ-26

**T-Head Pivot Bars**  
Use with Old Style system  
No longer available. Use: 96CQ-27

### New Style

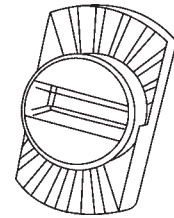
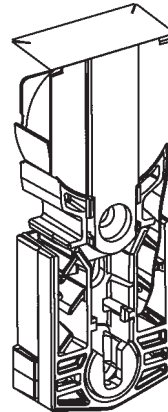

96CQ-18  
Friction Adjuster

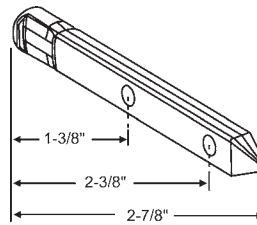

96CQ-24

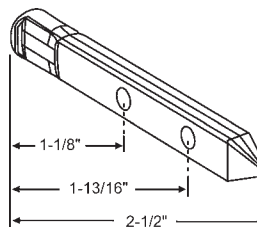

96CQ-23

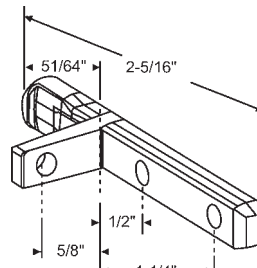

96CQ-27

**Round-Head Pivot Bars**  
Use when converting to quick tilt NC.

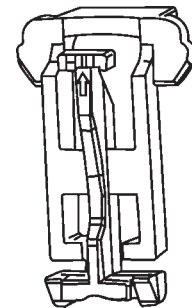

96CQ-17  
Tamper Lock

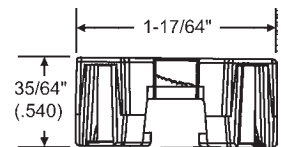
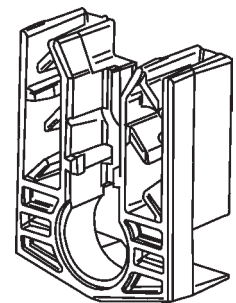

.540 Carrier

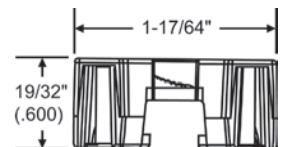

.600 Carrier

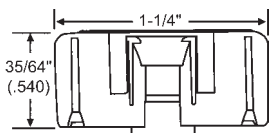

.540 Carrier

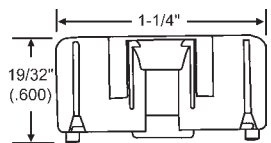

.600 Carrier



## 96CQ SERIES QUICK TILT CONSTANT FORCE BALANCES

Coil balance assemblies are listed by carrier thickness. These carriers use a round head pivot bar. Quick Tilt coil balances are sold as a complete set only.

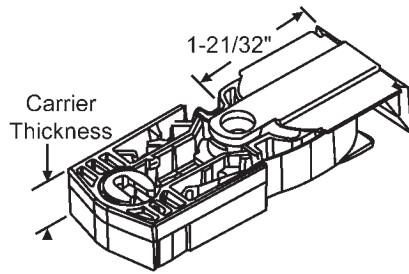

Single (RH Shown)

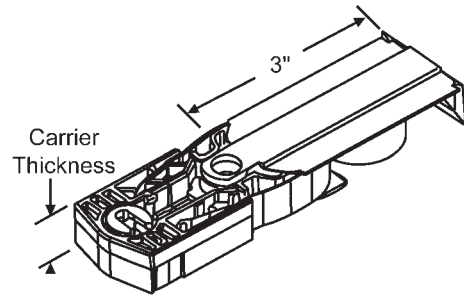

Tandem

Balance Assembly with .540 Carrier Thickness	Balance Assembly with .600 Carrier Thickness	Weight	Coil
96CQ-30RH	96CQ-31RH	3 lb. Cover Assy. RH	SINGLE
96CQ-32RH	96CQ-33RH	4 lb. Cover Assy. RH	SINGLE
96CQ-34RH	96CQ-35RH	5 lb. Cover Assy. RH	SINGLE
96CQ-36RH	96CQ-37RH	6 lb. Cover Assy. RH	SINGLE
96CQ-38RH	96CQ-39RH	7 lb. Cover Assy. RH	SINGLE
96CQ-40RH	96CQ-41RH	8 lb. Cover Assy. RH	SINGLE
96CQ-42RH	96CQ-43RH	9 lb. Cover Assy. RH	SINGLE
96CQ-30LH	96CQ-31LH	3 lb. Cover Assy. LH	SINGLE
96CQ-32LH	96CQ-33LH	4 lb. Cover Assy. LH	SINGLE
96CQ-34LH	96CQ-35LH	5 lb. Cover Assy. LH	SINGLE
96CQ-36LH	96CQ-37LH	6 lb. Cover Assy. LH	SINGLE
96CQ-38LH	96CQ-39LH	7 lb. Cover Assy. LH	SINGLE
96CQ-40LH	96CQ-41LH	8 lb. Cover Assy. LH	SINGLE
96CQ-42LH	96CQ-43LH	9 lb. Cover Assy. LH	SINGLE
96CQ-48	96CQ-49	10 lb. Cover Assy.	TANDEM
96CQ-50	96CQ-51	11 lb. Cover Assy.	TANDEM
96CQ-52	96CQ-53	12 lb. Cover Assy.	TANDEM
96CQ-54	96CQ-55	13 lb. Cover Assy.	TANDEM
96CQ-56	-	14 lb. Cover Assy.	TANDEM
96CQ-58	96CQ-59	15 lb. Cover Assy.	TANDEM
96CQ-60	96CQ-61	16 lb. Cover Assy.	TANDEM
96CQ-62	96CQ-63	17 lb. Cover Assy.	TANDEM
96CQ-64	96CQ-65	18 lb. Cover Assy.	TANDEM
96CQ-66	96CQ-67	19 lb. Cover Assy.	TANDEM
96CQ-68	96CQ-69	20 lb. Cover Assy.	TRIPLE

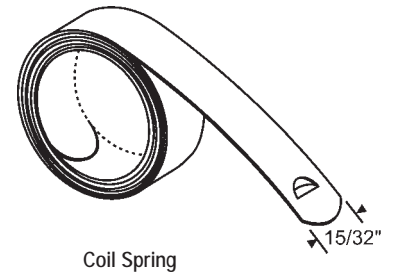

Coil Spring

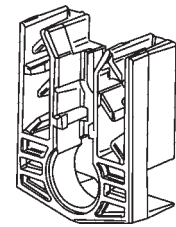

Carrier Body

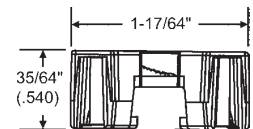

96CQ-13  
.540 Carrier

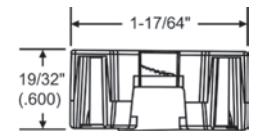

96CQ-15  
.600 Carrier

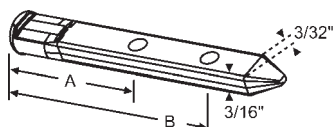

Round Head Pivot Bar

Part #	A	B	Overall Length
96CQ-23	1-1/8"	1-13/16"	2-1/2"
96CQ-24	1-3/8"	2-3/8"	2-7/8"

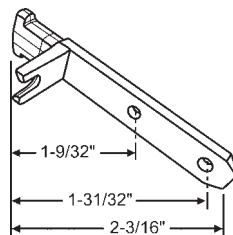

96CQ-28  
Quick Tilt Pivot Bar

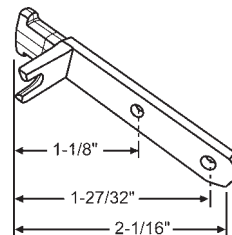

96CQ-29  
Quick Tilt Pivot Bar

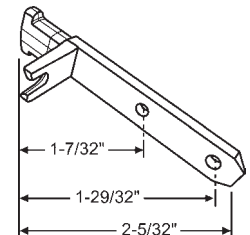

96CQ-30  
Quick Tilt Pivot Bar

# SASH SUPPORT SYSTEMS

## 96CR ROLLER TILT CONSTANT FORCE BALANCE SYSTEM

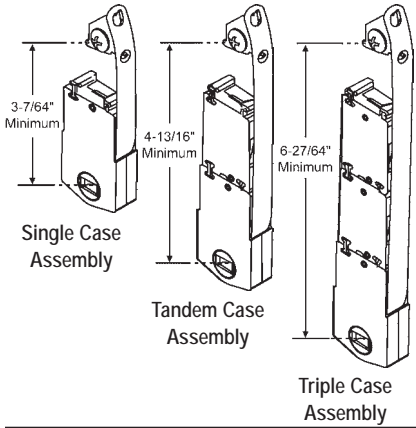

Note: All roller tilt components are sold separately.

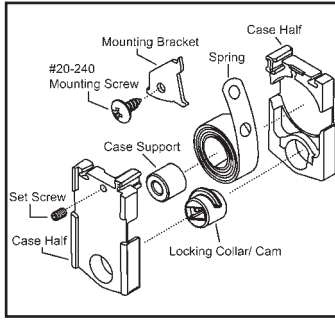

### STAINLESS STEEL COIL SPRING

Part #	Spring Capacity
96CR-1	#3
96CR-2	#4
96CR-3	#5
96CR-4	#6
96CR-5	#7
96CR-6	#8
96CR-7	#9

### CASE SUPPORT

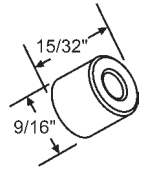

**96CR-521**  
Not required when using new, improved coil spring.

### LOCKING CASE HALVES

Need to order 2 halves to make up 1 case assembly

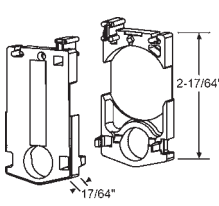

**96CR-522**  
Shown (2) 96CR-522

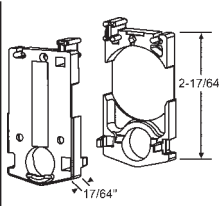

**96CR-523**  
Shown (1) 96CR-523 and (1) 96CR-522. For Tie in Bar

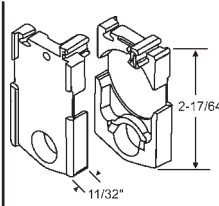

**96CR-524**  
Shown (2) 96CR-524

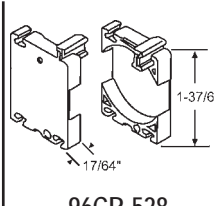

**96CR-528**  
Used to make tandem and triple case assembly. Shown (2) 96CR-528

### LOCKING COLLAR

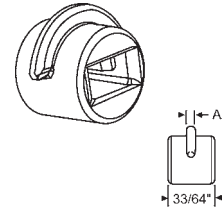

Part #	"A"	Color
96CR-502	3/32"	Blue
96CR-503	7/64"	Black
96CR-514	1/8"	Red

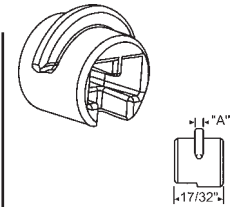

Part #	"A"	Color
96CR-519	3/32"	Blue
96CR-520	7/64"	Black

Tie-In Locking Collar

### MOUNTING BRACKETS

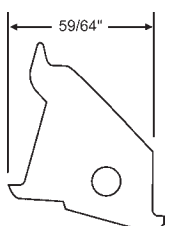

**96CR-504W**  
White

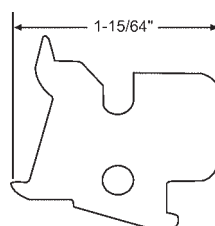

**96CR-513W**  
White

### SCREWS



**20-240**  
#8 Pan Head  
3/8" Long  
Mounting Screw.

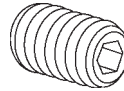

**96CR-506**  
6-32 x 1/4" Friction  
Adjustment Screw.

### ANTI DEBRIS WIPER

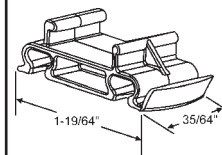

**96CR-517**

### CHIMNEY BLOCK

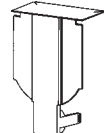

**96CR-529**  
Protects balance against dust and prevents air flow in jamb pocket. Cover will automatically position itself during operation of window.

### PIVOT BAR

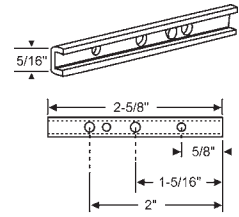

**900-15004**

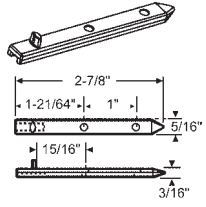

**96CR-20**  
Tie-In. Die Cast

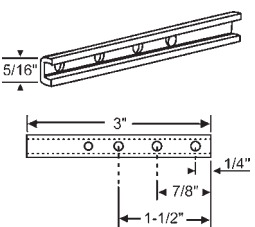

**85-627**

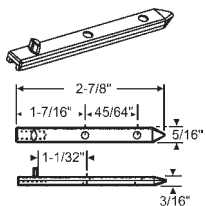

**96CR-21**  
Tie-In. Die Cast

### CARRIER ASSEMBLY FOR FLARED PIVOT BARS

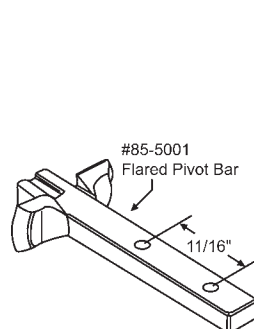
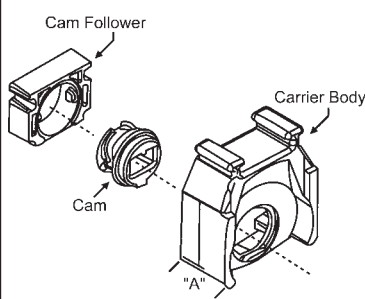

Carrier Assy. Part #	Cam Color	"A"
96CR-511	Natural	35/64" (.548)
96CR-509	Orange	37/64" (.581)
96CR-510	Black	39/64" (.613)

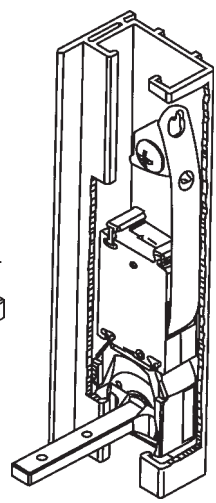

## 96M SERIES CONSTANT FORCE BALANCE SYSTEM

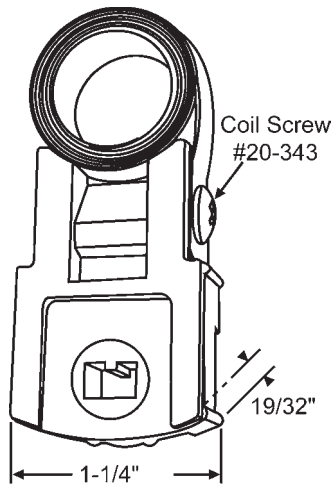

Old Style  
Use New Style from Chart Below

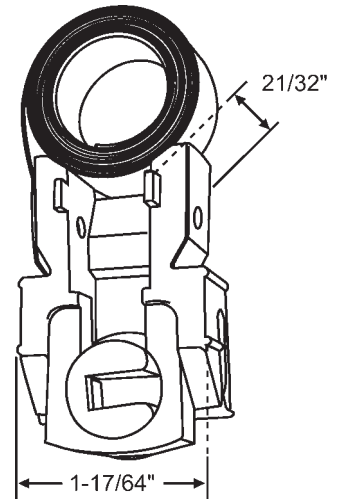
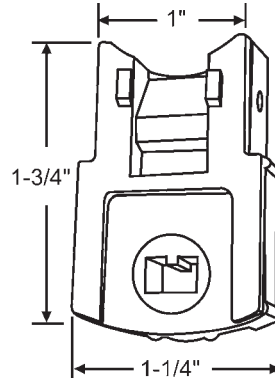

Part #	Single or Double Coil	Number Stamped on Coil
96-M26	Single	335
96-M9	Single	440
96-M5	Single	5 or 540
96-M3	Single	6 or 640
96-M7	Single	7 or 740
96-M28	Single	8 or 840
96-M21	Single	832
96-M6	Double	335/335
96-M17	Double	440/440
96-M8	Double	440/540
96-M10	Double	540/540
96-M12	Double	540/590
96-M11	Double	540/640
96-M27	Double	640/640
96-M13	Double	740/740
96-M29	Double	840/840

Part #	Single or Double Coil	Number Stamped on Coil
96-M22	Single	5 or 540
96-M3F	Single	6 or 640
96-M7F	Single	7 or 740
96-M28F	Single	8 or 840
96-M21F	Single	832
96-M17F	Double	440/440
96-M2	Double	440/540
96-M18	Double	540/540
96-M25	Double	540/640
96-M27F	Double	640/640
96-M29F	Double	840/840
96-M4	Double	740/740

## 96M SERIES CONSTANT FORCE BALANCE SYSTEM ACCESSORIES

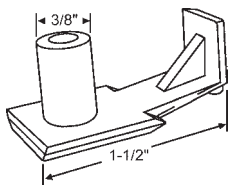

**96-M14C**  
Clip

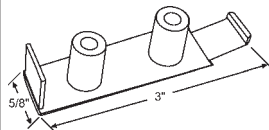

**96-M14**  
Detent Clip

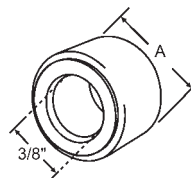

Part #	Color	A
96-M15	Dark Gray	21/32"
96-M15BL	Black	21/32"
96-M15BZ	Bronze	41/64"
96-M15G	Gray	11/16"
96-M15T	Tan	41/64"
96-M15W	White	43/64"

Bushing

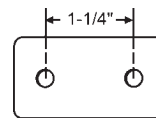

**96-M16**  
Guide

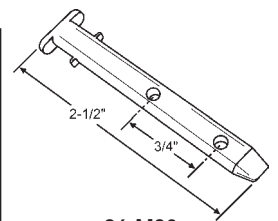

**96-M30**  
Pivot Bar. Zinc

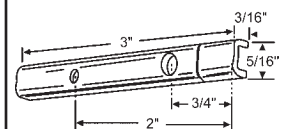

**96-M23**  
Universal Pivot Bar

# SASH SUPPORT SYSTEMS

## INTRODUCTION TO VINYL JAMBLINERS

**DON'T REPLACE - REPAIR** your old wood windows with new, thermally-efficient, rattle-free jambliners!

- Vinyl jambliners can reduce air infiltration dramatically and increase the efficiency of wood windows by over 60%!
- They are an excellent option when your customer's wood sash are in good shape but balances, pulleys and weatherstripping are not sufficient.
- We offer a stocking program of tilt and non-tilt jambliners for 1-1/4" and 1-3/8" sash and can provide custom sizes for most window shapes.
- We also provide single and double hung custom made jambliners for 1-3/4" sash. These are used primarily for historical renovations.
- Please refer to our easy-to-use jambliner chart on page 107 to help you determine the jambliner most suited to your customer's needs.
- We also offer a number of options not shown in this catalog. Please contact your account manager for any special requests!

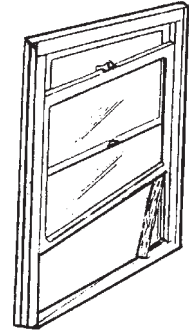

### HOW TO MEASURE YOUR EXISTING WINDOW OPENING

#### WIDTH

To find the width of the sash opening, measure from inside jamb to inside jamb. This measurement should be approximately 4" wider than the glass width.

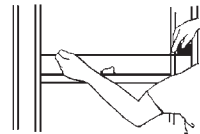
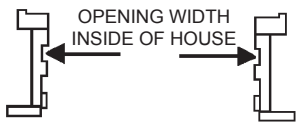

#### HEIGHT

To find the height of the opening, measure from the header to the sill at the inside edge of the parting bead. This measurement is normally about 6" greater than double the glass height. Also needed is the longest opening height.

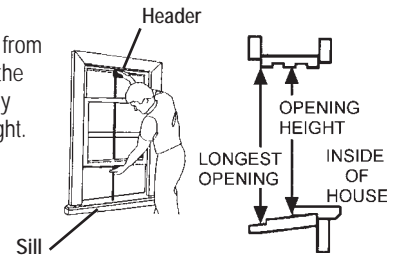

### HOW TO INSTALL NON-TILT JAMBLINERS

1. In order to accept our 86A, 86B, 86C, 86D jambliners, you must make a 5/8" wide x 5/8" deep square plough on both sides of the sash.

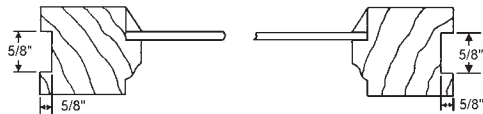

3. Set the lower and upper sash on a chair (per diagram) Note: sash are upside down with the interior (bare wood) towards the chair back.

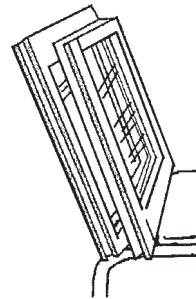

5. Pick up balance with sash so that the interior is facing you. Place the bottom of balance into window frame until it butts outside stop, then ease into position. Raise lower sash, thus driving speed lock into header to secure the balance. Tops of jambliner are slightly aligned for easier installation.

2. If you are replacing sash fitted with ropes or chains, it will be necessary to prepare your opening as follows:

- Cut off ropes or chains.
- Remove sash weight pulleys (four).
- Remove side parting beads; save the head parting bead as it will be reused.

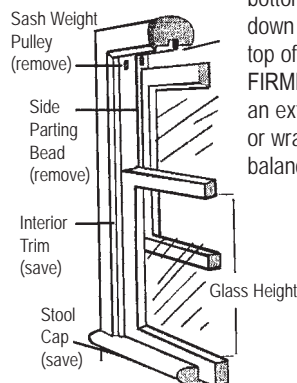

If you are only replacing defective or worn balances, you will need to remove all existing hardware and make room for your new sash/balance system.

4. Pick up balances with angle cut to top. Place balance with sash platforms resting on bottom of sash. Push sash down about 1-1/2" - 2" below top of balance and HOLD FIRMLY. Note: you may find an extra pair of hands helpful, or wrap tape around sash and balance to assist in handling.

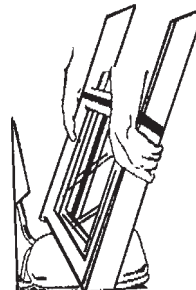

6. Check for proper fit, TEST OPERATION. Then replace stops, head parting bead and remainder of the interior trim.

Account# \_\_\_\_\_ Salesman \_\_\_\_\_ PO# \_\_\_\_\_ Date \_\_\_\_\_

# Jambliner Work Sheet

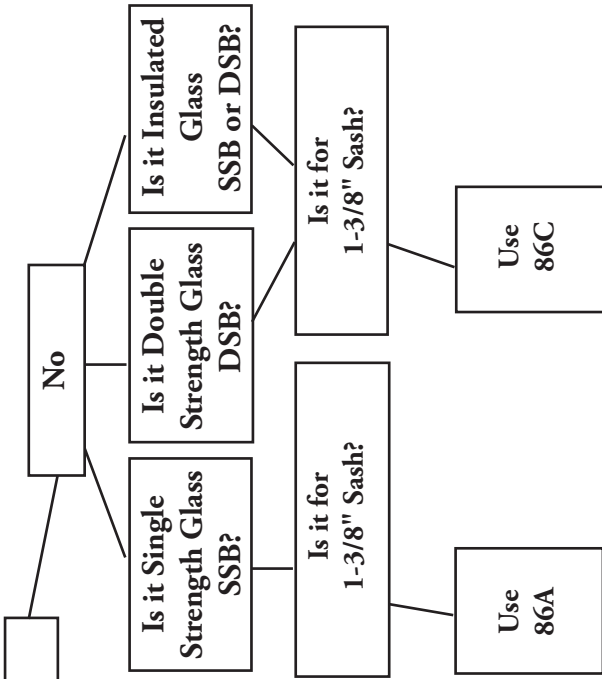

Sash size doesn't matter because parting bead is removed.

JAMBLINERS FOR THESE SERIES ONLY AVAILABLE IN BEIGE AND IN STANDARD SIZES.



Figure 1

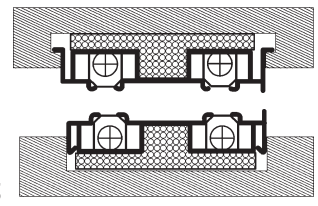

Figure 2

Balances for these Jambliners available in mill only. Jambliners available in white and beige.

### Answer Following Questions

Available in standard size only. Available in custom size. (smallest fraction we can cut is 1/16")

- Circle One: Balance # { 86A, 86B, 86C, 86D, 86E }
- Circle One: Sill Angle - Square Cut (Recommended), 15° (Most Common), 14°, 9°, 7°, 5°, Other \_\_\_\_\_
- Circle One: Color: Beige or White (86A, 86B, 86C & 86D Available in Beige Only)
- Circle One: Color of Balance: -Mill (Standard), White, Beige (86M, 86MF & 86MS Available in Mill Only)
- Circle One: Type of Glass: - Single Strength - Double Strength - Single Strength Insulated - Double Strength Insulated - Triple Glazed
- Circle One: Bracket Type - (Primarily used in retrofit) Flange Type - (Used in custom mfg.) - See Figure 1.
- Circle One: V plough or Square plough only applies to 86F, 86H, 86G, 86I. - See Figure 2.
- Visible Glass Height of Top Sash \_\_\_\_\_ Top Sash Weight \_\_\_\_\_
- Visible Glass Height of Bottom Sash \_\_\_\_\_ Bottom Sash Weight \_\_\_\_\_
- Glass Width (Top and Bottom Same) \_\_\_\_\_ Shortest Point \_\_\_\_\_
- Overall Length to Longest Point \_\_\_\_\_ Shortest Point \_\_\_\_\_

Note: Rule of thumb formula for calculating longest point is two times glass height plus 6-3/8" equals length to the longest point.

I understand this material is custom made to specifications as stated on this form and is non-returnable and non-cancelable.  
Signature of authorized buyer \_\_\_\_\_

Quantity \_\_\_\_\_ Part # \_\_\_\_\_ Price \_\_\_\_\_

# SASH SUPPORT SYSTEMS

## TILT JAMBLINERS WITH BLOCK AND TACKLE BALANCES

7000 SERIES / 9000 SERIES

Jambliners with block and tackle balances carry a higher weight range and provide smoother opening and closing compared to spring type balances. To determine which choice best suits your customer's needs, you need to determine:

1. **Bracket Type** - Used primarily in retrofit or flange type - used in custom manufacturing. (Refer to Figure 1.)
2. **V Plough or Square Plough** (Refer to Figure 2.)
3. **If converting from a non-tilt to a tilt system** - You will need to cut back sash 1-1/2" (Figure 1) and then plough sash as shown (Figure 2).  
Our chart on the following page offers standard industry sizes; however we can provide a variety of options. See our jambliner chart on page 107 for any special requests.
4. To purchase ribbed balances separately, see page 34 for 62A series.

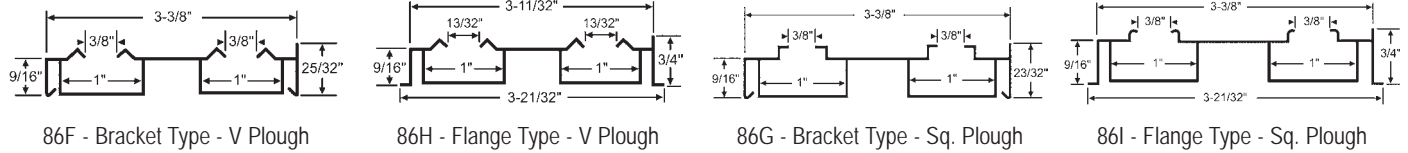
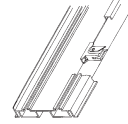

Figure 1

Bracket Type

Flange Type

V Plough

Figure 2

Square Plough

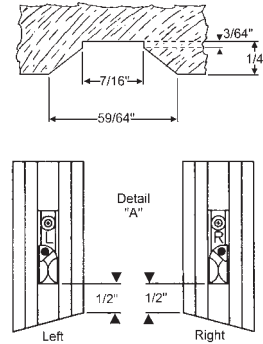
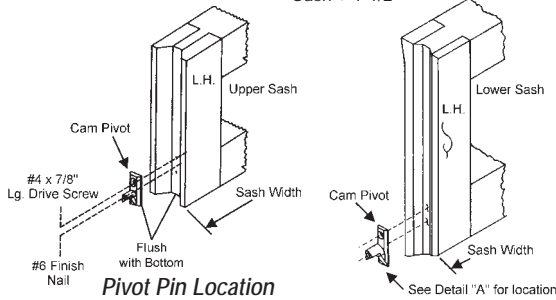

## 7000/9000 SERIES HARDWARE

### CAM PIVOTS

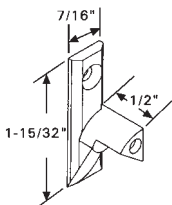

Part #	Description
62-650RH	Zinc
62-649RB	Black Plastic

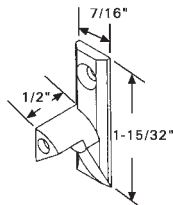

Part #	Description
62-650LH	Zinc
62-649LW	White Plastic

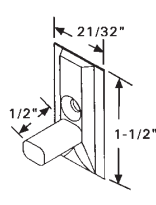

**62-652**  
Die Cast  
Square Plough

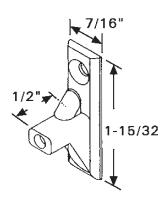

**62-653**  
Die Cast  
V Plough

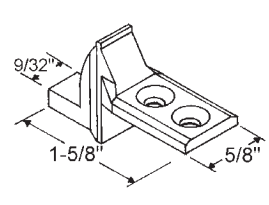

**62-656**  
**CARADCO**

### SASH STOP

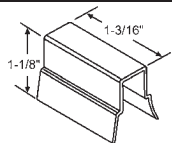

Part #	Color
62-701BG	Beige
62-701	White

### BALANCE CLIPS

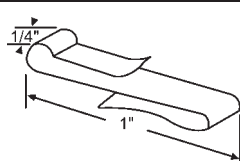

**62-517**

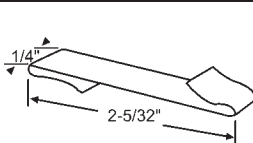

**62-518**

### INSTALLATION BRACKETS

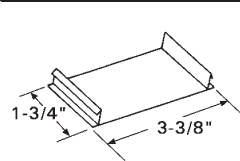

**86-21**  
Vinyl Release

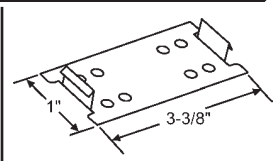

**86-22**  
Standard, Metal

## TILT JAMBLINERS WITH BLOCK AND TACKLE BALANCES

7000 Series Part # for Standard Jambliner Sets 15° with Standard Lengths.

When ordering any of these Jambliners, identify the number you need and add part number to Jambliner form, sign and fax to our office.

Glass Height	Number Stamped on Balance	Balance Length	Approx. Sash Weight Capacity	86F White Bracket Type V Plough	86H White Flange Type V Plough	86G White Bracket Type Square Plough	86I White Flange Type Square Plough	Length to Longest Point
12"	12 REG	13"	8-11 lbs.	86F-15°-30-3/8	86H-15°-30-3/8	86G-15°-30-3/8	86I-15°-30-3/8	30-3/8"
12"	12HD	13"	12-14 lbs.	86F-15°-30-3/8HD	86H-15°-30-3/8HD	86G-15°-30-3/8HD	86I-15°-30-3/8HD	30-3/8"
14"	14 REG	15"	10-15 lbs.	86F-15°-34-3/8	86H-15°-34-3/8	86G-15°-34-3/8	86I-15°-34-3/8	34-3/8"
14"	14 HD	15"	15-22 lbs.	86F-15°-34-3/8HD	86H-15°-34-3/8HD	86G-15°-34-3/8HD	86I-15°-34-3/8HD	34-3/8"
16"	16 REG	17"	10-17 lbs.	86F-15°-38-3/8	86H-15°-38-3/8	86G-15°-38-3/8	86I-15°-38-3/8	38-3/8"
16"	16HD	17"	17-22 lbs.	86F-15°-38-3/8HD	86H-15°-38-3/8HD	86G-15°-38-3/8HD	86I-15°-38-3/8HD	38-3/8"
18"	18 REG	19"	10-17 lbs.	86F-15°-42-3/8	86H-15°-42-3/8	86G-15°-42-3/8	86I-15°-42-3/8	42-3/8"
18"	18 HD	19"	17-22 lbs.	86F-15°-42-3/8HD	86H-15°-42-3/8HD	86G-15°-42-3/8HD	86I-15°-42-3/8HD	42-3/8"
20"	20 REG	21"	10-17 lbs.	86F-15°-46-3/8	86H-15°-46-3/8	86G-15°-46-3/8	86I-15°-46-3/8	46-3/8"
20"	20 HD	21"	17-20 lbs.	86F-15°-46-3/8HD	86H-15°-46-3/8HD	86G-15°-46-3/8HD	86I-15°-46-3/8HD	46-3/8"
20"	20 TG	21"	20-30 lbs.	86F-15°-46-3/8TG	86H-15°-46-3/8TG	86G-15°-46-3/8TG	86I-15°-46-3/8TG	46-3/8"
22"	22 REG	23"	10-18 lbs.	86F-15°-50-3/8	86H-15°-50-3/8	86G-15°-50-3/8	86I-15°-50-3/8	50-3/8"
22"	22 HD	23"	18-22 lbs.	86F-15°-50-3/8HD	86H-15°-50-3/8HD	86G-15°-50-3/8HD	86I-15°-50-3/8HD	50-3/8"
22"	22 TG	23"	22-30 lbs.	86F-15°-50-3/8TG	86H-15°-50-3/8TG	86G-15°-50-3/8TG	86I-15°-50-3/8TG	50-3/8"
24"	24 REG	25"	10-18 lbs.	86F-15°-54-3/8	86H-15°-54-3/8	86G-15°-54-3/8	86I-15°-54-3/8	54-3/8"
24"	24 HD	25"	18-22 lbs.	86F-15°-54-3/8HD	86H-15°-54-3/8HD	86G-15°-54-3/8HD	86I-15°-54-3/8HD	54-3/8"
24"	24TG	25"	22-30 lbs.	86F-15°-54-3/8TG	86H-15°-54-3/8TG	86G-15°-54-3/8TG	86I-15°-54-3/8TG	54-3/8"
26"	26 REG	27"	10-19 lbs.	86F-15°-58-3/8	86H-15°-58-3/8	86G-15°-58-3/8	86I-15°-58-3/8	58-3/8"
26"	26 HD	27"	19-24 lbs.	86F-15°-58-3/8HD	86H-15°-58-3/8HD	86G-15°-58-3/8HD	86I-15°-58-3/8HD	58-3/8"
26"	26 TG	27"	24-31 lbs.	86F-15°-58-3/8TG	86H-15°-58-3/8TG	86G-15°-58-3/8TG	86I-15°-58-3/8TG	58-3/8"
28"	28 REG	29"	15-22 lbs.	86F-15°-62-3/8	86H-15°-62-3/8	86G-15°-62-3/8	86I-15°-62-3/8	62-3/8"
28"	28 HD	29"	22-28 lbs.	86F-15°-62-3/8HD	86H-15°-62-3/8HD	86G-15°-62-3/8HD	86I-15°-62-3/8HD	62-3/8"
28"	28 TG	29"	28-35 lbs.	86F-15°-62-3/8TG	86H-15°-62-3/8TG	86G-15°-62-3/8TG	86I-15°-62-3/8TG	62-3/8"
30"	30 REG	31"	15-23 lbs.	86F-15°-66-3/8	86H-15°-66-3/8	86G-15°-66-3/8	86I-15°-66-3/8	66-3/8"
30"	30 HD	31"	23-29 lbs.	86F-15°-66-3/8HD	86H-15°-66-3/8HD	86G-15°-66-3/8HD	86I-15°-66-3/8HD	66-3/8"
30"	30 TG	31"	30-36 lbs.	86F-15°-66-3/8TG	86H-15°-66-3/8TG	86G-15°-66-3/8TG	86I-15°-66-3/8TG	66-3/8"
32"	32 REG	33"	15-24 lbs.	86F-15°-70-3/8	86H-15°-70-3/8	86G-15°-70-3/8	86I-15°-70-3/8	70-3/8"
32"	32 HD	33"	24-29 lbs.	86F-15°-70-3/8HD	86H-15°-70-3/8HD	86G-15°-70-3/8HD	86I-15°-70-3/8HD	70-3/8"
32"	32 TG	33"	29-36 lbs.	86F-15°-70-3/8TG	86H-15°-70-3/8TG	86G-15°-70-3/8TG	86I-15°-70-3/8TG	70-3/8"
34"	34 REG	35"	15-24 lbs.	86F-15°-74-3/8	86H-15°-74-3/8	86G-15°-74-3/8	86I-15°-74-3/8	74-3/8"
34"	34 HD	35"	24-29 lbs.	86F-15°-74-3/8HD	86H-15°-74-3/8HD	86G-15°-74-3/8HD	86I-15°-74-3/8HD	74-3/8"
34"	34 TG	35"	29-36 lbs.	86F-15°-74-3/8TG	86H-15°-74-3/8TG	86G-15°-74-3/8TG	86I-15°-74-3/8TG	74-3/8"
36"	36 REG	37"	15-24 lbs.	86F-15°-78-3/8	86H-15°-78-3/8	86G-15°-78-3/8	86I-15°-78-3/8	78-3/8"
36"	36 HD	37"	24-29 lbs.	86F-15°-78-3/8HD	86H-15°-78-3/8HD	86G-15°-78-3/8HD	86I-15°-78-3/8HD	78-3/8"
36"	36TG	37"	29-38 lbs.	86F-15°-78-3/8TG	86H-15°-78-3/8TG	86G-15°-78-3/8TG	86I-15°-78-3/8TG	78-3/8"
38"	38 REG	39"	15-25 lbs.	86F-15°-82-3/8	86H-15°-82-3/8	86G-15°-82-3/8	86I-15°-82-3/8	82-3/8"
38"	38 HD	39"	24-29 lbs.	86F-15°-82-3/8HD	86H-15°-82-3/8HD	86G-15°-82-3/8HD	86I-15°-82-3/8HD	82-3/8"
38"	38 TG	39"	29-38 lbs.	86F-15°-82-3/8TG	86H-15°-82-3/8TG	86G-15°-82-3/8TG	86I-15°-82-3/8TG	82-3/8"
40"	40 REG	41"	15-25 lbs.	86F-15°-86-3/8	86H-15°-86-3/8	86G-15°-86-3/8	86I-15°-86-3/8	86-3/8"
40"	40 HD	41"	25-30 lbs.	86F-15°-86-3/8HD	86H-15°-86-3/8HD	86G-15°-86-3/8HD	86I-15°-86-3/8HD	86-3/8"
40"	40 TG	41"	30-38 lbs.	86F-15°-86-3/8TG	86H-15°-86-3/8TG	86G-15°-86-3/8TG	86I-15°-86-3/8TG	86-3/8"
42"	42 REG	43"	15-25 lbs.	86F-15°-90-3/8	86H-15°-90-3/8	86G-15°-90-3/8	86I-15°-90-3/8	90-3/8"
42"	42 HD	43"	25-30 lbs.	86F-15°-90-3/8HD	86H-15°-90-3/8HD	86G-15°-90-3/8HD	86I-15°-90-3/8HD	90-3/8"
42"	42 TG	43"	30-38 lbs.	86F-15°-90-3/8TG	86H-15°-90-3/8TG	86G-15°-90-3/8TG	86I-15°-90-3/8TG	90-3/8"

To order beige jambliners, add "B" after part number. Example: 86F-15°-30-3/8HDB

Note: For all variations or specials please refer to chart on page 107.

All balances for jambliners are supplied in mill finish. If color balances are required, please fill out form on page 107

# SASH SUPPORT SYSTEMS

## HEAVY DUTY MAGNUM TILT JAMBLINERS FOR 1-3/4" SASH

- The magnum jambliners are the choice for historical restorations.
- Can carry up to 80 lb. sash weights; however, sash over 48" height and 50 lbs. must have limited travel.
- Magnums are offered for both double hung and single hung. Single hung is an excellent choice when top sash is fixed -cost is dramatically reduced.
- Double hung is offered in bracket type or flange type. Single hung is bracket type only.
- Available in white or beige finishes.
- Sets include hardware. Top retainer and can be used to make jambliners non-tilt. Hardware includes (2) RH and (2) LH pivots, (2) sash stops and (2) sash retainers for lower sash. For bracket type installation up to 54", use (4) brackets per set; up to 84", use (6) brackets per set; 84", use (8) brackets per set.

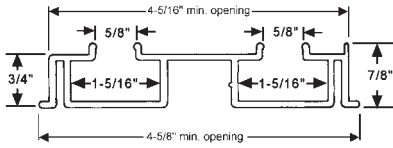

86MF - Flange Type

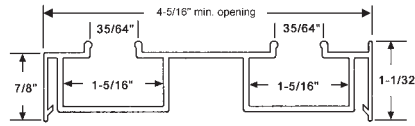

86M - Bracket Type

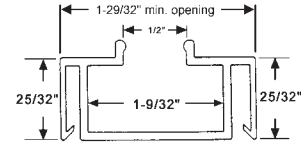

86MS - Bracket Type

\*Magnum series is not a stock item and must be custom made. Please fill out information below.  
These items are non-returnable.

1. Circle one: Do you want single hung (86 MS) or double hung jambliner?
2. Circle one: If double hung -do you want bracket type (86M) or flange type (86MF)?
3. Circle one: beige or white
4. Circle one: sill angle-square cut (recommended) 15° (most common), 14°, 9°, 7°, 5°, other \_\_\_\_\_
5. Visible glass height of top sash \_\_\_\_\_, top sash weight \_\_\_\_\_
6. Visible glass height of bottom sash \_\_\_\_\_, bottom sash weight \_\_\_\_\_
7. Glass width (top and bottom same) \_\_\_\_\_
8. Overall length to longest point \_\_\_\_\_ shortest point \_\_\_\_\_

Example: 86M-Sq-76S45B means double-hung, bracket type jambliner (86M), square cut (Sq.), 76" long, 45 lbs. beige (B).

### 86M - 86MF - 86MS HARDWARE

Hardware is included with jambliner set. These items can also be purchased separately.

#### CAM PIVOTS

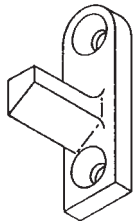

62-651LH

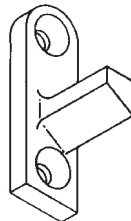

62-651RH

#### SASH STOP

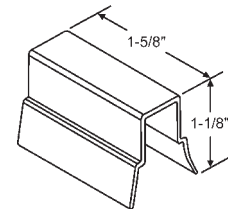

Part #	Color
62-702	White
62-702BG	Beige

#### SASH RETAINERS

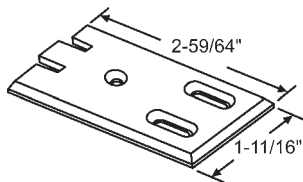

Part #	Color
62-657BR	Brown
62-657	White

#### INSTALLATION BRACKETS

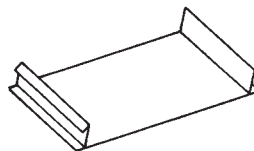

86-16  
Single Hung Bracket

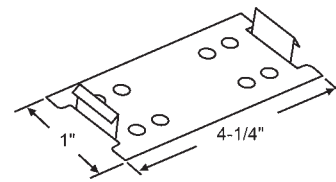

86-9  
Double Hung Bracket



### Sash Preparation for Single and Double Hung

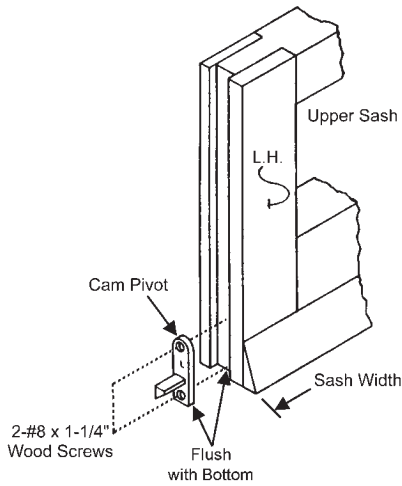
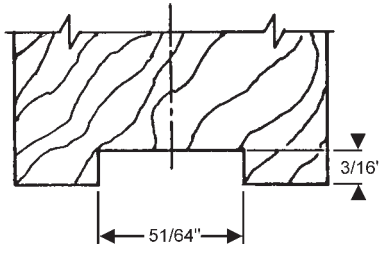

### Double Hung Frame Applications and Sash Pre-fit

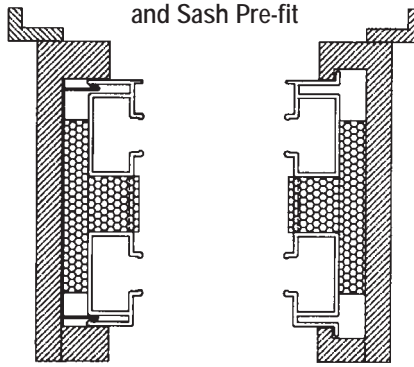

Bracket Flange

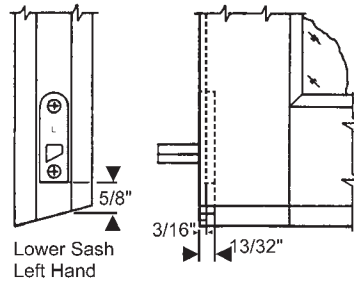

Lower Sash Left Hand

### Single Hung Frame Applications and Sash Pre-fit

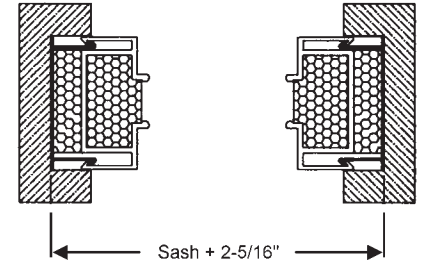

Detail "A"

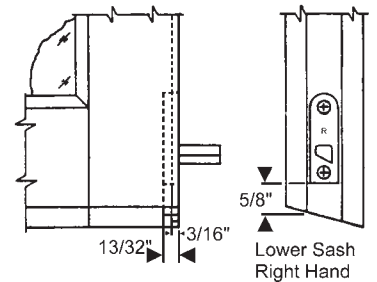

Lower Sash Right Hand

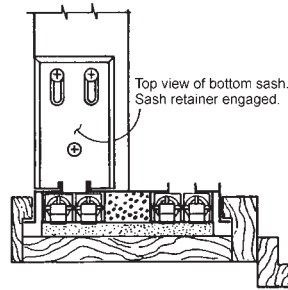

Top view of bottom sash. Sash retainer engaged.

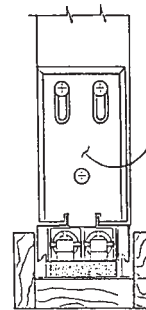

Top view of bottom sash. Sash retainer engaged.

### Frame Jamb Preparation for Bracket Application

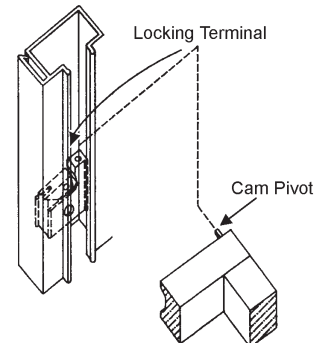
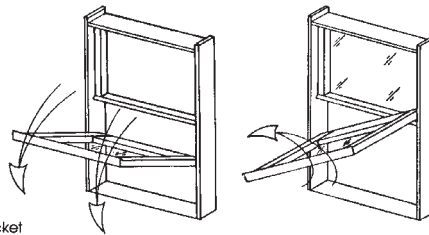
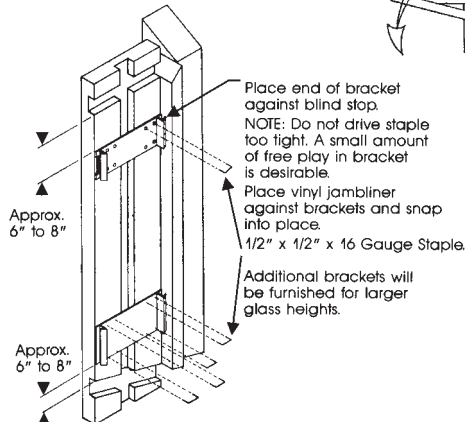
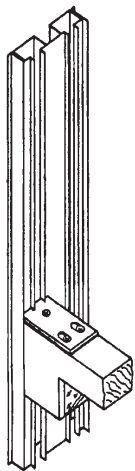

# SASH SUPPORT SYSTEMS

## TILT JAMBLINERS

### HOW TO INSTALL TILT JAMBLINERS

1. If you are converting a window from a Non-Tilt to a Tilt window or if you are retrofitting a window that previously used pulleys or other balances -you must cut back the sash by 11/16" on each side, reducing the overall sash width by 1-3/8". (See Figure 1.)

Figure 1

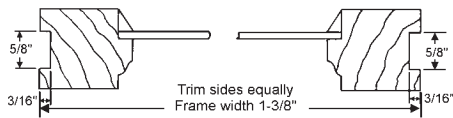

2. Make a 5/8" square x 3/16" deep plough on both sides of sash. (See Figure 1.)

3. Apply jambliners to jambs, with bottom touching the sill and flange side touching the blind stop. Press jambliner and drive screws until head is flush with liner. Readjustment of screws may be necessary during STEP 5.

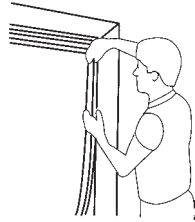

4. Install sash brackets in upper and lower sash as shown below.

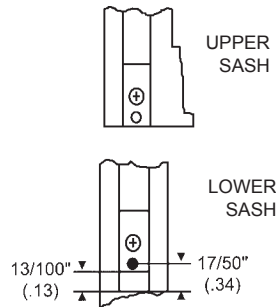

5. Insert upper sash into opening in full tilt position. Align pivot pins in the proper channel above carriers. Allow pins to drop into carriers. Pivot sash into place. Repeat for lower sash. Then reinstall the inside trim stops and head parting stop.

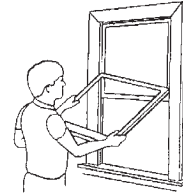

### Screw Mount

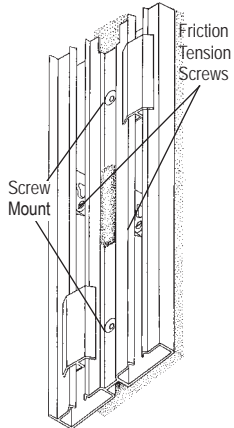

Series 86E

For Tilt Windows with Either Single Strength or Insulated Glass  
86E Series for 1-3/8" or 1-1/4" Sash  
Max Opening Height for 86E Series is 7-6 (90")

Glass Size	Opening Height	Height	Beige Part #	White Part #	Standard Sash Weight	Heavy Duty Beige Part #	Heavy Duty White Part #	Heavy Duty Sash Weight	Length to Longest Point
12"	2-6	30"	-	86E-30W	11 lbs.	-	86E-30WHD	15 lbs.	30-7/16"
14"	2-10	34"	86E-34	86E-34W	13 lbs.	86E-34HD	86E-34WHD	16 lbs.	34-7/16"
16"	3-2	38"	86E-38	86E-38W	14 lbs.	86E-38HD	86E-38WHD	18 lbs.	38-7/16"
18"	3-6	42"	86E-42	86E-42W	15 lbs.	86E-42HD	86E-42WHD	19 lbs.	42-7/16"
20"	3-10	46"	86E-46	86E-46W	16 lbs.	86E-46HD	86E-46WHD	21 lbs.	46-7/16"
22"	4-2	50"	86E-50	86E-50W	18 lbs.	86E-50HD	86E-50WHD	23 lbs.	50-7/16"
24"	4-6	54"	86E-54	86E-54W	19 lbs.	86E-54HD	86E-54WHD	25 lbs.	54-7/16"
26"	4-10	58"	86E-58	86E-58W	20 lbs.	86E-58HD	86E-58WHD	26 lbs.	58-7/16"
28"	5-2	62"	86E-62	86E-62W	22 lbs.	86E-62HD	86E-62WHD	28 lbs.	62-7/16"
30"	5-6	66"	86E-66	86E-66W	23 lbs.	86E-66HD	86E-66WHD	30 lbs.	66-7/16"
32"	5-10	70"	86E-70	86E-70W	24 lbs.	86E-70HD	86E-70WHD	32 lbs.	70-7/16"
34"	6-2	74"	86E-74	86E-74W	26 lbs.	86E-74HD	86E-74WHD	33 lbs.	74-7/16"

### JAMBLINER SASH STOP

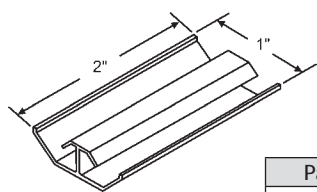

Part #	Color
86E-700BG	Beige
86E-700W	White

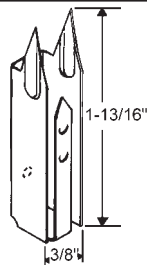

86-701BG  
Beige Metal

### JAMBLINER TILT PIVOT

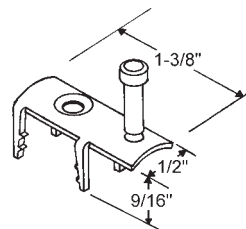

86E-600

Above items included in set.

Full cartons contain 16 sets per box • Each set is individually wrapped with hardware enclosed. Stocked in beige color - White available - Special order • 14° standard sill angle. Please contact your account manager for special sizes or Cottage, Carriage and Oriel windows. Refer to chart on page 107.

### JAMBLINER ACCESSORIES

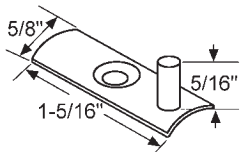

900-15114  
Sash Bracket

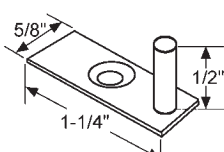

900-14923  
Tilt Pin

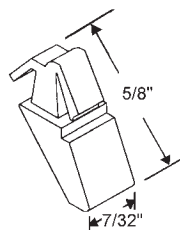

900-21058  
Nylon Retainer  
NEWELL

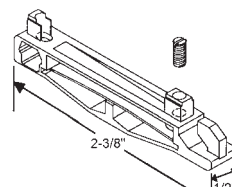

900-21068  
DH Shoe  
NEWELL

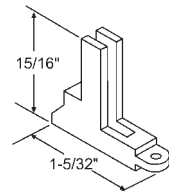

Part #	Description
900-5713	Nylon
900-5713M	Metal

Clutch for Jambliner  
MARVIN

## NON-TILT JAMBLINERS

For Single Strength Glass  
86A Series for 1-3/8" Sash

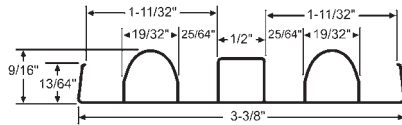

Series 86A

Jambliner Sash Stop

**86-701BG**  
Beige Metal

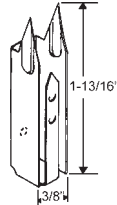

Glass Size	Opening Height	1-3/8" Part #	Maximum Sash Weight	Length to Longest Point
12"	2-6 - 30"	86A-30	7.8 lbs.	30-3/16"
14"	2-10 - 34"	86A-34	8.5 lbs.	34-3/16"
16"	3-2 - 38"	86A-38	9.2 lbs.	38-3/16"
18"	3-6 - 42"	86A-42	9.9 lbs.	42-3/16"
20"	3-10 - 46"	86A-46	10.6 lbs.	46-3/16"
22"	4-2 - 50"	86A-50	11.3 lbs.	50-3/16"
24"	4-6 - 54"	86A-54	12.0 lbs.	54-3/16"
26"	4-10 - 58"	86A-58	12.7 lbs.	58-3/16"
28"	5-2 - 62"	86A-62	13.4 lbs.	62-3/16"
30"	5-6 - 66"	86A-66	14.1 lbs.	66-3/16"
32"	5-10 - 70"	86A-70	14.8 lbs.	70-3/16"
34"	6-2 - 74"	86A-74	15.5 lbs.	74-3/16"
36"	6-6 - 78"	86A-78	15.5 lbs.	78-3/16"

Full cartons contain 20 sets per box.

Only available in beige color • 14° standard sill angle

Please contact your account manager for special sizes or Cottage, Carriage and Oriel Windows. Refer to chart on page 107.

For Insulated or Double Strength Glass  
86C Series for 1-3/8" Sash

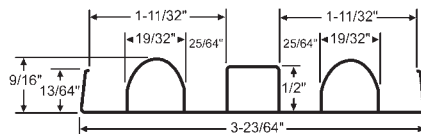
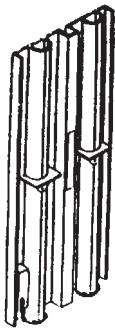

Series 86C

Jambliner Sash Stop

**86-701BG**  
Beige Metal

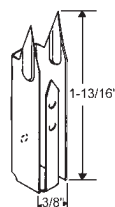

Glass Size	Opening Height	1-3/8" Part #	Maximum Sash Weight	Length to Longest Point
12"	2-6 - 30"	86C-30	11.0 lbs.	30-3/16"
14"	2-10 - 34"	86C-34	12.3 lbs.	34-3/16"
16"	3-2 - 38"	86C-38	13.5 lbs.	38-3/16"
18"	3-6 - 42"	86C-42	14.8 lbs.	42-3/16"
20"	3-10 - 46"	86C-46	16.0 lbs.	46-3/16"
22"	4-2 - 50"	86C-50	17.3 lbs.	50-3/16"
24"	4-6 - 54"	86C-54	18.5 lbs.	54-3/16"
26"	4-10 - 58"	86C-58	19.9 lbs.	58-3/16"
28"	5-2 - 62"	86C-62	21.0 lbs.	62-3/16"
30"	5-6 - 66"	86C-66	22.2 lbs.	66-3/16"
32"	5-10 - 70"	86C-70	23.5 lbs.	70-3/16"
34"	6-2 - 74"	86C-74	24.7 lbs.	74-3/16"
36"	6-6 - 78"	86C-78	26.0 lbs.	78-3/16"

Full cartons contain 20 sets per box.

Only available in beige color • 14° standard sill angle

Please contact your account manager for special sizes or Cottage, Carriage and Oriel Windows. Refer to chart on page 107.

# SASH SUPPORT SYSTEMS

## 86 SERIES NON-TILT BOSTON STYLE JAMBLINER 1-3/8"

(Brockway Smith)

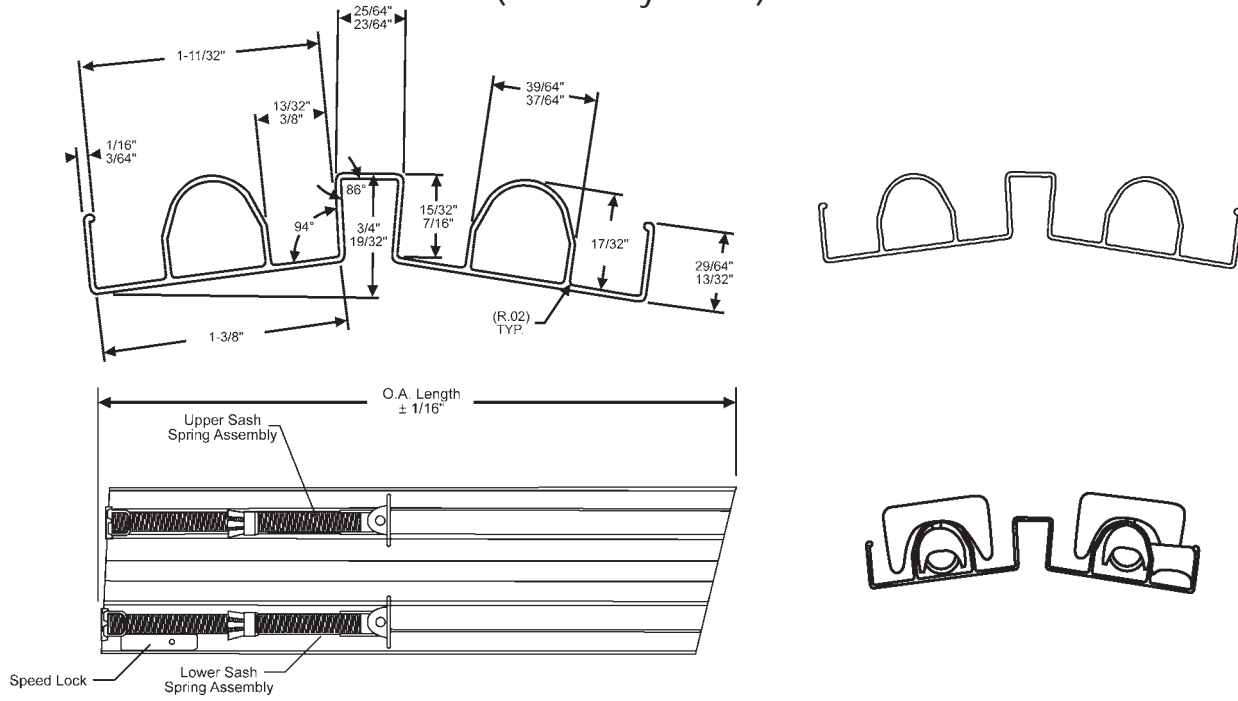

Our Part #	Unit Size	Overall Length $\pm 1/16''$	Color
86BOS-25	2-1	25-23/64"	Beige
86BOS-29	2-5	29-23/64"	Beige
86BOS-30	2-6	30-23/64"	Beige
86BOS-31	2-7	31-23/64"	Beige
86BOS-33	3-1	33-23/64"	Beige
86BOS-37	2-5	37-23/64"	Beige
86BOS-41	3-5	41-23/64"	Beige
86BOS-45	3-9	45-23/64"	Beige
86BOS-49	4-1	49-23/64"	Beige
86BOS-50	4-2	50-23/64"	Beige
86BOS-53	4-5	53-23/64"	Beige
86BOS-55	4-7	55-23/64"	Beige
86BOS-57	4-9	57-23/64"	Beige
86BOS-59	4-11	59-23/64"	Beige
86BOS-61	5-1	61-23/64"	Beige
86BOS-65	5-5	65-23/64"	Beige
86BOS-69	5-9	69-23/64"	Beige
86BOS-73	6-1	73-23/64"	Beige
86BOS-77	6-5	77-23/64"	Beige
86BOS-81	6-9	81-23/64"	Beige
86BOS-85	7-1	85-23/64"	Beige
86BOS-89	7-5	89-23/64"	Beige
86BOS-90	7-6	90-23/64"	Beige
86BOS-16/24	16/24 (Oriel)	45-23/64"	Beige
86BOS-18/26	18/26 (Oriel)	49-23/64"	Beige
86BOS-20/30	20/30 (Oriel)	55-23/64"	Beige
86BOS-24/16	24/16 (Oriel)	45-23/64"	Beige
86BOS-26/18	26/18 (Oriel)	49-23/64"	Beige
86BOS-30/20	30/20 (Oriel)	55-23/64"	Beige

Note: Other sizes and variations are also available. Please contact your account manager for more information

## SASH LOCKS

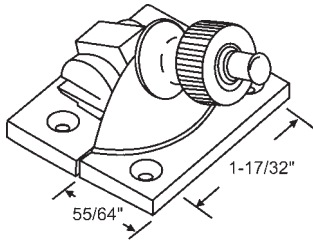

Part #	Finish
50-1096BRS	Polished Brass
50-1096CH	Chrome Plated

Spring Action. Solid Brass  
**MIGHTON**

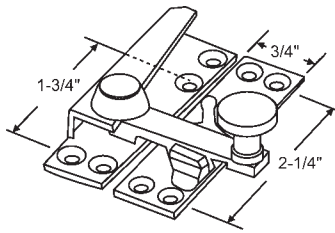

Part #	Finish
50-1097BRS	Polished Brass
50-1097CH	Chrome Plated

Solid Brass  
**MIGHTON**

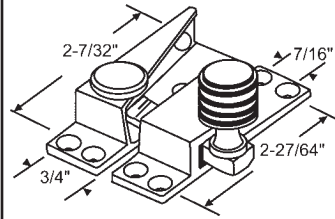

Part #	Finish
50-1098BRS	Polished Brass

Solid Brass  
**MIGHTON**



### 50-443

The Model 50-443 is a traditional pattern sash lock. It is a beautifully elegant lock in polished brass with a burned finial. It is designed for use on large and heavy sash such as found in institutional or public buildings.

Base Dimensions: 1" X 3"  
Strike Dimensions: 1/2" X 3"



### 50-445

The Model 50-445 sash lock is designed for use on the check rails of large or inaccessible double-hung sash which are to be locked and unlocked using a pole. The extended locking arm on this lock makes it especially suitable for the 1-3/4" and 2-1/4" thick sash usually found in large public or institutional buildings. It is hot-forged from solid brass and comes in a polished and lacquered finish.

Lock Base Dimensions and Strike Base Dimensions: 13/16" X 2-3/8"

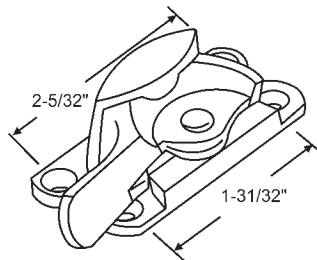

Sweep Height 11/16"

Part #	Finish
50-1099BRS	Polished Brass
50-1099CH	Chrome Plated

Solid Brass  
**MIGHTON**

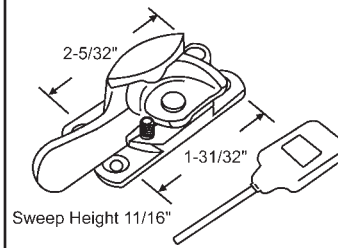

Sweep Height 11/16"

Part #	Finish
50-1100BRS	Polished Brass
50-1100CH	Chrome Plated

Solid Brass  
**MIGHTON**

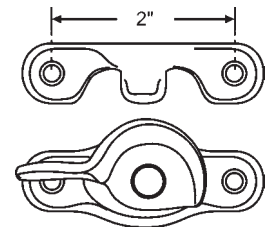

Sweep Height 5/8"

Part #	Finish
50-748	Solid Brass, Polished Lacquered
50-634A	Die Cast, Brass Plated

Includes Keeper



Part #	Finish
50-440	Lacquered Polished Brass
50-440ORBZ	Oil-Rubbed Bronze
50-440PNK	Polished Nickel
50-440SNK	Satin Nickel

The Model 50-440 is a new sash lock developed to combine the best features of traditional spring action locks with an updated narrow strike. No effort has been spared to make the 50-440 the finest, most durable sash lock of its type. The quality of finish and smoothness of function are without equal. All components of this lock are hot-forged brass and stainless steel, precisely machined and hand polished.

Base Dimensions: 1" X 2-7/8"  
Strike Dimensions: 7/16" X 2-7/8"

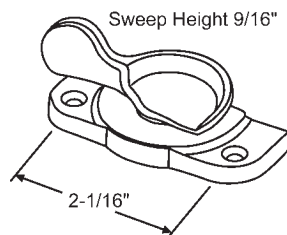

Part #	Finish
50-471-1	Bronze
50-471-5	Brass Plated
50-471-71	Oil-Rubbed Bronze

Restoration lock. Zinc die cast screws not included.

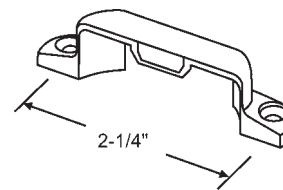

Part #	Finish
50-472-1	Bronze
50-472-5	Brass Plated
50-472-71	Oil-Rubbed Bronze

Keeper. Zinc die cast screws not included.

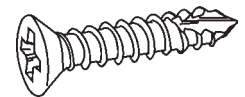

Part #	Finish
20-109-1	Bronze
20-109-5	Brass Plated

Screws for 50-471 Sash Lock and 50-472 Keeper

## LIFTS & PULLS

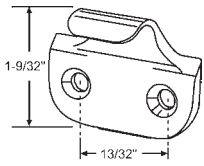

Part #	Finish
50-475-5	Brass Plated
50-475-13	Brushed Copper Nickel
50-475-71	Oil-Rubbed Bronze
50-475-72	Brushed Chrome
50-475-3	White

Includes Two Screws  
Zinc Die Cast

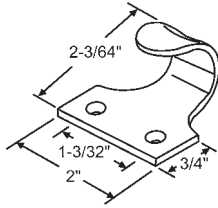

Part #	Finish
50-1101BRS	Polished Brass
50-1101CH	Chrome Plated

Solid Brass  
**MIGHTON**



**50-461**

The Model 50-461 and 50-462 are hook-type sash lifts based on traditional patterns. They are used singly on sash up to 2 feet wide and in pairs on larger sash. Both lifts are solid, hot-forged brass, hand polished.

Dimensions: 3/4" w X 1-3/8" h X 1" d  
Dimensions: 1" w X 1-3/4" h X 1-1/4" d



**50-462**

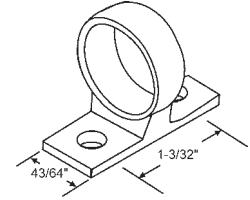

Part #	Finish
50-1102BRS	Polished Brass
50-1102CH	Chrome Plated
50-1102SCH	Satin Chrome

Ring Pull. Solid Brass  
**MIGHTON**

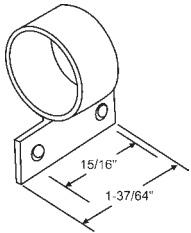

Part #	Finish
50-1103BRS	Polished Brass
50-1103CH	Chrome Plated
50-1103SCH	Satin Chrome

Ring Pull. Solid Brass  
**MIGHTON**



**50-449**

The Model 50-449 is a flush sash lift based on a traditional pattern. It is used singly on sash up to 2 feet wide and in pairs on larger sash. It is hot-forged from solid brass and hand polished.

Dimensions: 1-3/4" X 3-1/8"



**50-451**

A solid cast brass handle type sash lift in a traditional pattern. The off-set design improves hand clearance between the handle and window stool, especially when width is limited. Used singly on sash up to 2 feet wide and in pairs on larger sash.

Dimensions: 15/16" X 4-1/4"

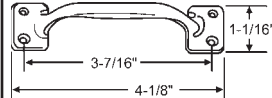

**50-455-1**

Solid Brass  
Bright Brass Finish  
with Screws

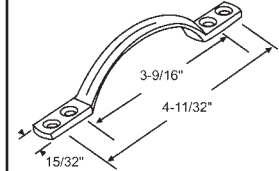

Part #	Finish
50-1104BRS	Polished Brass

D Handle w/Square Edge (shown)

Part #	Finish
50-1104CH	Chrome Plated

D Handle w/Round Edge. Solid Brass  
**MIGHTON**

## BRASS/STEEL PULLEYS

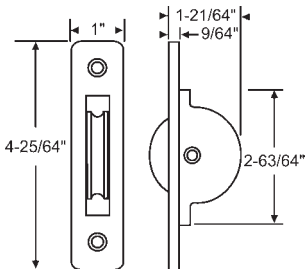

Square Corners - 2 Hole

Part #	Body Material	Body Shape	Face Plate	Wheel Type/Size	Max Load Capacity
96-MT3	Steel Body	Square Corners	Brass	1-3/4" Nylon	55 lbs.
96-MT5	Steel Body	Square Corners	Brass	1-3/4" Brass	55 lbs.
96-MT7	Steel Body	Square Corners	Plated Steel	1-3/4" Nylon	55 lbs.
96-MT9	Steel Body	Square Corners	Plated Steel	1-3/4" Brass	55 lbs.
96-MT11	Steel Body	Square Corners	Chrome Plated Brass	1-3/4" Chrome Plated Brass	110 lbs.

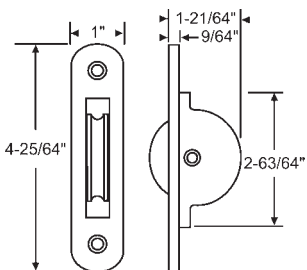

Rounded Corners - 2 Hole

Part #	Body Material	Body Shape	Face Plate	Wheel Type/Size	Max Load Capacity
96-MT4	Steel Body	Round Corners	Brass	1-3/4" Nylon	55 lbs.
96-MT6	Steel Body	Round Corners	Brass	1-3/4" Brass	55 lbs.
96-MT8	Steel Body	Round Corners	Plated Steel	1-3/4" Nylon	55 lbs.
96-MT10	Steel Body	Round Corners	Plated Steel	1-3/4" Brass	55 lbs.
96-MT12	Steel Body	Round Corners	Chrome Plated Brass	1-3/4" Chrome Plated Brass	110 lbs.

## BRASS/STEEL PULLEYS

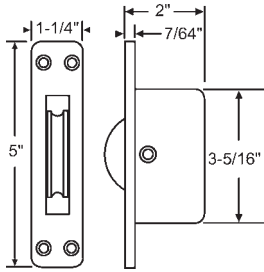

Square Corners - 4 Hole

Part #	Body Material	Body Shape	Face Plate	Wheel Type/Size	Max Load Capacity
96-MT13	Steel Body	Square Corners	Chrome Plated Brass	2" Chrome Plated Brass Ball Bearing	176 lbs.
96-MT15	Steel Body	Square Corners	Chrome Plated Brass	2-1/4" Chrome Plated Brass Ball Bearing	176 lbs.
96-MT17	Steel Body	Square Corners	Brass	2" Brass Ball Bearing	176 lbs.
96-MT19	Steel Body	Square Corners	Brass	2-1/4" Brass Ball Bearing	176 lbs.
96-MT22	Steel Body	Square Corners	Stainless Steel	2" Stainless Steel	55 lbs.

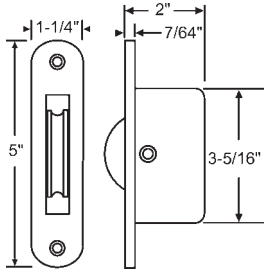

Round Corners - 2 Hole

Part #	Body Material	Body Shape	Face Plate	Wheel Type/Size	Max Load Capacity
96-MT14	Steel Body	Round Corners	Chrome Plated Brass	2" Chrome Plated Brass Ball Bearing	176 lbs.
96-MT16	Steel Body	Round Corners	Chrome Plated Brass	2-1/4" Chrome Plated Brass Ball Bearing	176 lbs.
96-MT18	Steel Body	Round Corners	Brass	2" Brass Ball Bearing	176 lbs.
96-MT20	Steel Body	Round Corners	Brass	2-1/4" Brass Ball Bearing	176 lbs.

## POLYSASH PULLEYS

## SASH CHAIN



96-P1

The Model 96-P1 is a larger, redesigned version of our popular ball bearing sash pulley. It has been designed to meet the needs of custom high-end window fabricators building large and heavy sash. The Model 96-P1 features a hot forged solid brass 1-1/8" x 5-7/16" radius end faceplate, 2-1/2" solid brass precision turned pulley wheel for chain or cord, and a sealed ball-bearing for many years of smooth operation. The standard finish is satin lacquered. Faceplate Dimensions: 1-1/8" x 5-7/16" Housing Dimensions: 2-3/16" x 3-1/4" x 3/4"

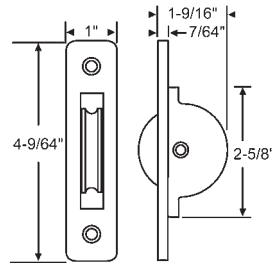

96-MT1

Polyethylene Body, Square Corners, 1-3/4" Nylon Wheel. 2 Holes  
Max Load Capacity = 20 lbs.

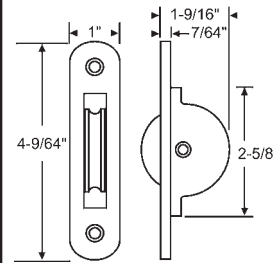

96-MT2

Polyethylene Body, Round Corners, 1-3/4" Nylon Wheel. 2 Holes  
Max Load Capacity = 20 lbs.

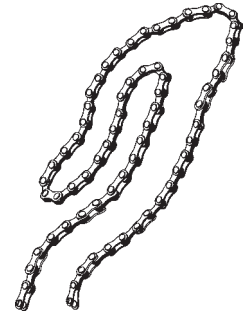

Part #	Weight
96-805	Up to 70 lbs.
96-806	Up to 165 lbs.

Steel Chain w/Copper Rivets Only. Order Connectors Separately. 50' Rolls

**MIGHTON**

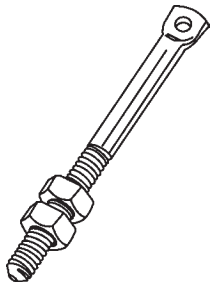

96-807

Weight Connector for Riveted Chain

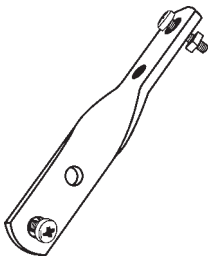

96-808

Sash Connector for Riveted Chain



96-708

Spiral Clip. Fits into 7/8" diameter hole bored into side of sash stile. Threads onto the end of sash chain. Plated steel.

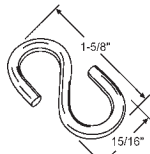

96-709

S Hook. Used for attaching chain to stackable counter weights. Plated steel

Sash Chain is preferred over sash cord in instances where greater longevity is required such as in high quality residential construction, restoration work, and public buildings. Our solid bronze, solid brass, and stainless steel sash chains will give many years of reliable service.



96-701

#45 Solid Bronze Load Limit 160 lbs. 150' per roll.

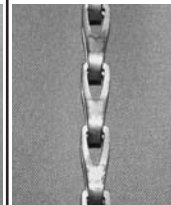

96-702

#25 Solid Bronze Load Limit 80 lbs. 100' per roll.



96-703

#3 Solid Brass Load Limit 100 lbs. 100' per roll.

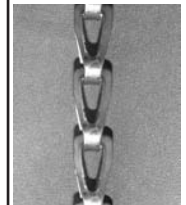

96-706

#35 Stainless Steel Load Limit 225 lbs. 100' per roll.

# ARCHITECTURAL HARDWARE

## SASH CORDS & ACCESSORIES

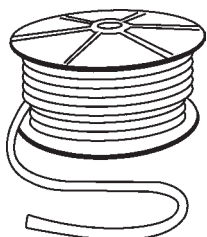

Part #	Length
96-802	65' Roll
96-803	164' Roll
96-804	328' Roll

Load Limit 220 lbs.  
1/4" Nylon Cord  
**MIGHTON**

Our pre-stretched, premium waxed cotton sash cord has an inner synthetic-stranded cord for increased strength and flexibility. The outer covering of plaited waxed and polished premium grade cotton is designed specifically for use with pulley systems and will give many years of smooth and trouble-free performance.



Part #	Size	Load	Length
96-704	#8 (1/4")	100 lbs.	100'
96-705	#10 (5/16")	200 lbs.	100'
96-710	#4 (1/8")	20 lbs.	600'

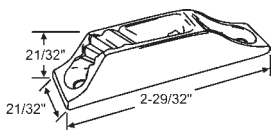

Grabba is an essential piece of kit in the joiners' armory.

- One man operation
- No need for hammer or nails
- Simple sash cord adjustment
- Faster fitting time
- Neat appearance

On bigger windows, where a sash weight is over 22 lbs, there will still be a need to pin the cord.

**96-809**  
Black Plastic

## SASH COUNTERWEIGHTS



Our 96 series stackable cast iron counterweights are designed to economically facilitate the balancing of sash in weight and pulley windows. The 1/2" through-hole permits their use with either rope or chain. The square and radius cross-section provides more weight per inch than conventional round weights, essential when dealing with heavier glazing or insulating glass. The 1 lb., 3 lbs., and 5 lbs. sizes permit flexibility and precision in attaining a proper balance. They are suitable for 1-3/4" or larger sash in either new construction or retrofit.

Part #	Weight	Height
96-700-5	5 lbs.	7-7/8"
96-700-3	3 lbs.	5-1/8"
96-700-1	1 lb.	2-3/8"

## ACCESSORIES

## SPRING BOLTS

## MISCELLANEOUS

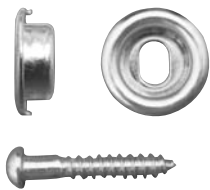

Part #	Finish
19-321	Solid Brass
19-321ORBZ	Oil Rubbed Bronze

**Stop Bead Adjuster**  
A solid brass stop bead adjuster for mounting removable window stops. The slotted screw hole permits 1/8" of lateral adjustment. They are supplied in boxes of 50 pieces with accompanying #8 x 1" wood screws.



### 19-317

The Model 19-317 is a surface mounted window spring bolt designed for holding a vertical or horizontal sliding sash in either an open or closed position. The spring plunger may be locked into its fully retracted position by a simple rotation of the spherical knob. The window spring bolt is especially suited for retrofitting to older windows lacking balance systems or to any sash requiring a multi-position lock. The Model 19-317 is precision extruded and machined from solid brass and hand polished. Three strike plates are furnished with each lock. Base Dimensions: 1-1/8" x 1-1/4" Strike Dimensions: 5/8" x 1-7/16"



### 19-318

The Model 19-318 is a solid brass window spring bolt designed for installation in the wood stile of a vertically sliding sash. This type of hardware is commonly used in pairs on light weight, single hung sash in lieu of a balance system or sash lock, and is designed to be press-fit into a 3/8" diameter hole bored through the sash stile. A hole to accept the spring plunger is then bored in the window jamb to hold the sash at any desired height. The Model 19-318 is precision turned solid brass with a stainless steel spring. Housing Dimensions: 1-7/8" x 3/8" Overall Length: 3-3/8"

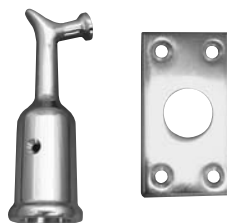

### 39-572

### 39-573

The Model 39-572 pole hook and Model 39-573 pole hook socket are intended to facilitate the operation of large or inaccessible double-hung windows. The pole hook is designed to be mounted on the end of a wooden operating pole of an appropriate length. The 39-573 pole socket is easily mounted in the sash rail, requiring only the boring of a 1" diameter hole. Both items are solid cast brass with a polished and lacquered finish. Model 39-572 Dimensions: 4"L x 7/8" I.D. Model 39-573 Dimensions: 1-1/4" x 2-1/4"

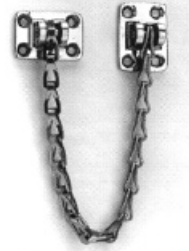

### 19-320

The Model 19-320 transom chain is designed to limit the opening of transom sash or other bottom hinged windows. The chain brackets are solid, polished and lacquered brass. The 12" chain is solid bronze. Base Dimensions: 1-3/16" x 1" x 11/16"

## VENT LOCKS

### Key Operated Vent Lock

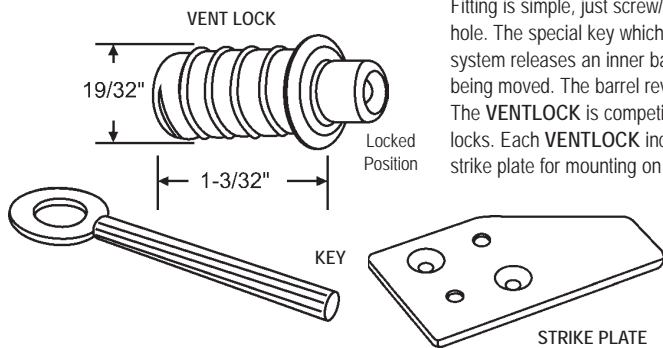

The new innovative VENTLOCK acts as a major deterrent to snatch thieves who spot what they consider is an easily opened window. Fitting is simple, just screw/insert it into the appropriate diameter drill hole. The special key which is supplied as part of the VENTLOCK system releases an inner barrel which prevents the window from being moved. The barrel revolves freely preventing it from being cut. The VENTLOCK is competitively priced against existing window locks. Each VENTLOCK includes a steel operation key and a brass strike plate for mounting on the lower sash check rail.

Part #	Finish
50-446	Solid Brass
50-446CH	Chrome

Vent Lock with Key and Strike  
**MIGHTON**

MEETS: ASTM F 2090 Standard Specification for Window Fall Prevention Devices With Emergency Escape (Egress) Release Mechanisms

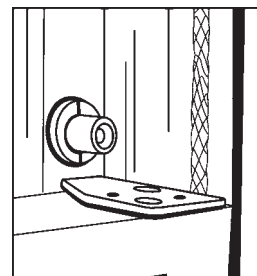

Open Position Shown



## VENT LOCKS AND ACCESSORIES

### Push and Twist Keyless Vent Lock

Finger Operated: Push and Turn with Your Finger

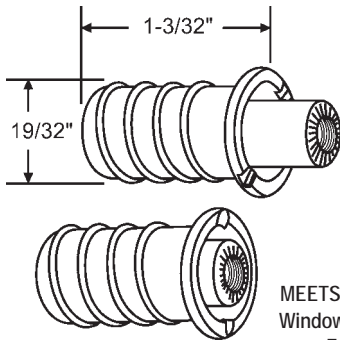

The natural companion product to Key Operated Ventlocks. Use where Fire Egress may be of concern or above ground floor level.

Part #	Finish
50-1201CH	Chrome
50-1201BRS	Solid Brass

Push and Twist Ventlock. Solid Brass  
**MIGHTON**

MEETS: ASTM F 2090 Standard Specification for Window Fall Prevention Devices With Emergency Escape (Egress) Release Mechanisms

### Brass Vent Lock for PVC Vinyl Windows

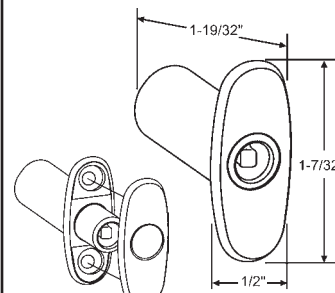

Ventlock is Quick and Easy to Install

1. Drill Hole
2. Insert Ventlock
3. Drill Rivet Holes
4. POP Rivet Ventlock into the Sash
5. Conceal Rivets with Self Adhesive Trims

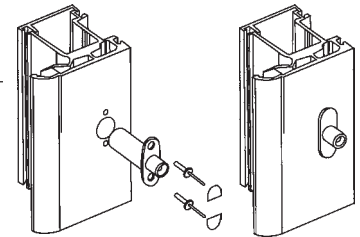

**50-1106**  
Vent Lock for PVC Vinyl Windows  
Includes Key  
**MIGHTON**

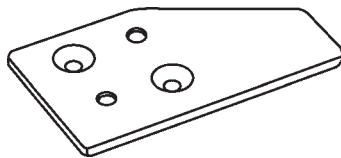

Part #	Finish
50-1105BRS	Solid Brass
50-1105CH	Chrome
50-1105SCH	Satin Chrome

Vent Lock Strike Plate Only  
**MIGHTON**

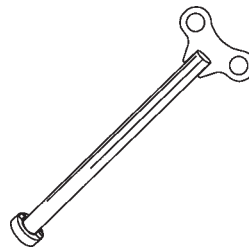

**59-73M**  
Ventlock Hand Tool  
**MIGHTON**

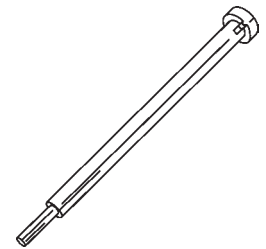

**59-73**  
Ventlock Tool for Cordless Drill  
**MIGHTON**

## CASEMENT HARDWARE



Part #	Hand
34-79RH	Shown
34-79LH	Opposite

The Model 34-79 casement fastener is hot-forged solid brass and hand polished. Available either right or left-handed.  
Base Dimensions: 11-16" X 2-3/8"  
Handle: 2"  
Overall Depth: 1-1/4"  
Strike sold separately.



Part #	Hand
34-77RH	Shown
34-77LH	Opposite

The newly redesigned Model 34-77 casement fastener is hot-forged from solid brass and hand polished. Available either right or left-handed.  
Base Dimensions: 11/16" X 2-3/8"  
Handle: 3-1/2"  
Overall Depth: 1-7/8"  
Strike sold separately.



**50-453**



**50-454**



**50-463**



**50-464**

### Strike Plates for Casement Fasteners

Part #	Description
50-453	Mortise Strike
50-454	Surface Strike
50-463	Rim Strike
50-464	Angle Strike (for use on windows with compression weatherstripping)



**29-204**  
(Out-Swing Shown/Brackets Invert for In-Swing)

The model 29-204 is a 12-1/2" solid polished brass slide-bar type adjuster for wood in-swing or out-swing windows. Based on a traditional pattern, this beautifully made casement adjuster is designed so as not to interfere with hinged or rolling interior screens whether in the open or closed position. For universal (left or right hand) operation.

Overall Length: 12-1/2"  
Overall Height: 2-3/8"  
Overall Depth: 1-3/8"

# ARCHITECTURAL HARDWARE

## CASEMENT HARDWARE



29-205

The Model 29-205 sliding rod casement adjuster is a highly finished version of a traditional American pattern. It is designed for use on out-swing hinged windows. The 29-205 is hot-forged and precision machined from solid brass and hand polished. Base Dimensions: 15/16" X 2-3/8"  
Overall Length: 13-1/2"  
Overall Height: 2"



29-206

The Model 29-206 telescopic friction casement stay is a highly finished, heavy-duty version of a pattern common to early 20th century casement windows. It is designed for installation on all types of out-swinging hinged sash. The degree of friction may be adjusted by means of the large brass nut at the barrel end. The 29-206 is offered in solid brass, with a hand polished and lacquered finish.

## SCREEN HARDWARE



Part #	Finish
17-155	Polished Lacquered
17-155SNK	Satin Nickel

The newly redesigned Model 17-155 is a solid brass screen or storm door latch set. The lock case, escutcheon plate and strike are hot-forged and precision machined for smooth operation. The spring mechanism is stainless steel. The lever and threaded spindle are hot-forged in one piece for added strength, and the knob is turned from brass bar stock. The latch set is supplied with an angle strike and a rim strike. Backset is 1-9/16". The threaded spindle allows easy adjustment for door thicknesses of 1-1/8" to 1-3/4". Thinner doors can be accommodated by cutting the spindle. Dimensions: Case 2-1/4" X 2"  
Back Plate 1-1/4" X 4" Knob 1-5/8" dia.  
Overall Depth: Lever side 1-7/16" Knob side 1-1/2"

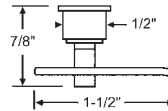

19-319

The Model 19-319 cam fastener is a solid brass assembly designed to fasten wood storm or screen inserts into a combination door or other frame. The standard finish is unlacquered.

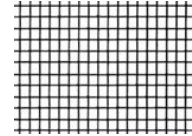

Part #	Size
69-29BR	24" x 100'
69-65BR	36" x 100'
69-77BR	48" x 100'

### Bronze Insect Screening

Our heavy-duty solid bronze insect screening is designed for fabrication of high quality window screens and screen doors. It is woven of .011" solid bronze wire into an 18 X 14 mesh.

## PARTING BEAD

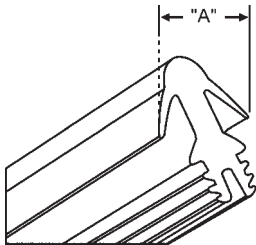

One-piece parting bead that weather-strips both top and bottom sashes. The fins are almost undetectable when installed. Will never rot. Made from UV-stabilized PVC. Simple to install. Can be used on new construction or restoration. Takes the rattle out of old sash windows. Severe weatherproof rating.

Part #	Color	Length	"A"
63-330	White	94-1/2"	15/32"
63-332	White	94-1/2"	5/8"

**MIGHTON**

## BRUSH SEAL

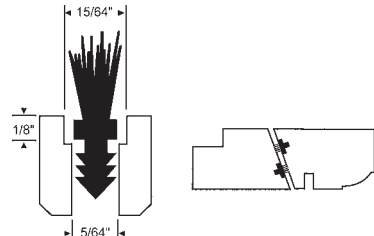
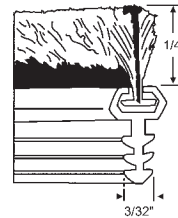

Part #	Color	Length
63-336	White	86-3/4"

**MIGHTON**

Simple to install. Low friction pile with single polypropylene fin which provides 50% easier sash movement while providing maximum resistance to air and water penetration. Long life performance.

## WEATHERSTRIP

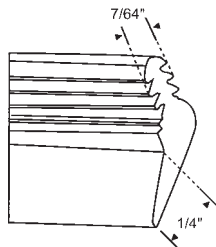

Part #	Finish	Length
63-334	White	94-1/2"
63-335	Brown	94-1/2"

Standard Weatherstrip  
**MIGHTON**

## MINI GROOVER

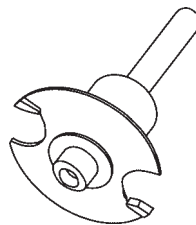

59-74

Mini Groover for Standard Weatherstrip 63-334 & 63-335 Requires 1/4" Chuck.

**MIGHTON**

## HINGES

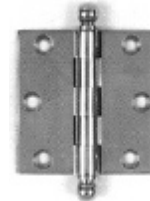

Part #	Size
19-322	3" x 3"
19-323	3-1/2" x 3-1/2"
19-324	4" x 4"

Our 19 series polished brass butt hinges are designed for use on wood casement windows and doors. The hinge body is precision extruded brass, .125" thick, and has removable ball tips. The finish is hand polished and lacquered. Sold in pairs.

## SWEEP LOCKS & SASH LOCKS



### Innovative and Intuitive!

The Roto Flip Lock is an automatic sash lock for single hung, double hung, and sliding windows that's easy to install, easy to operate, and highly intuitive. Flip Lock's excellent balance and durability combined with its intuitive and sleek design, provides you with a superior lock while providing your customers with great comfort, convenience and security.

#### Features

- The positive action lock, once unlocked and the sash is opened, resets itself and then locks automatically when the sash is closed
- Innovative functionality that makes operation of the lock ergonomically- friendly
- Internal mechanism has two springs to maintain balance
- Four mounting positions
- Unique Breakaway feature – flip lever will stay up unless completely closed
- Meets or exceeds forced entry resistance requirements and hurricane impact testing

#### Benefits

- Ease of operation and peace of mind knowing that once the window is closed, it is locked
- In the case of arthritic conditions, the lock can be operated with a slim device thus not requiring extensive movement of one's fingers
- Enhanced durability/cycle performance, reliable, consistent functionality
- Ultimate flexibility to position the lock correctly on various profiles
- Acts as a visible indicator that the window is not completely closed, thus not locked
- Adds vital elements of security and strength to the overall performance of the window

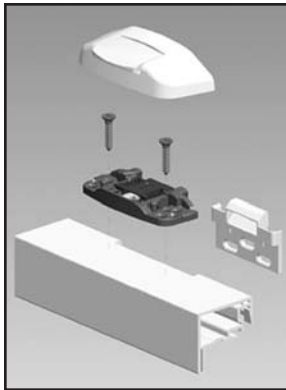

Flip Lock Mechanism

Part Number
50-1326



Face Mount Striker

Part Number	Color
50-1328W	White
50-1328BEW	Blue White
50-1328EB	Earth Brown
50-1328AD	Almond
50-1328ADMK	Dark Almond/Beige



Surface Mount Striker

Part Number	Color
50-1327W	White
50-1327BEW	Blue White
50-1327EB	Earth Brown
50-1327AD	Almond
50-1327ADMK	Almond MK
50-1327AG	Adobe



Flip Lock Cover Assembly

Part Number	Color
50-1325W	White
50-1325BEW	Blue White
50-1325EB	Earth Brown
50-1325AD	Almond
50-1325ADMK	Dark Almond/Beige



Installation Jig

Part Number
59-82

## SWEEP LOCKS & SASH LOCKS

In order by mounting hole width (single hole locks first).

#### Single Hole

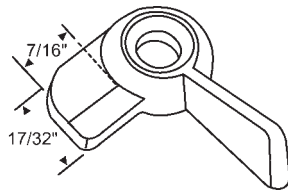

Part #	Finish
900-7277	Unfinished

Zinc Die Cast

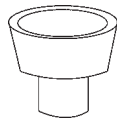
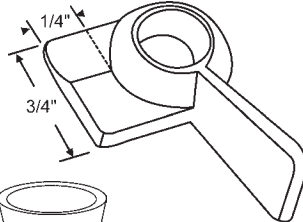

50-625

Plastic Bushing Insert

Lock only

Part #	Hand	Finish
50-624RH	Shown	Brite
50-624LH	Opposite	Brite

Lock with Bushing and Screw

Part #	Hand	Finish
50-624RHA	Shown	Brite
50-624LHA	Opposite	Brite

Zinc Die Cast

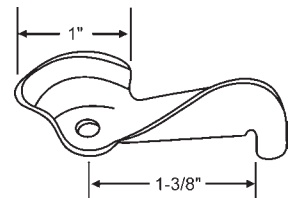

Part #	Hand
50-604	Shown

Stamped Steel

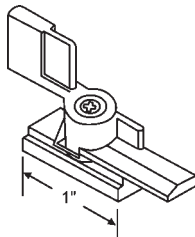

Part #	Finish
50-715	Unfinished

Zinc Die Cast

**CROSSLY**

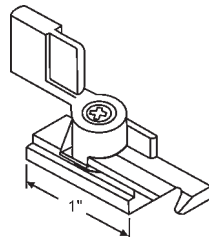

Part #	Finish
50-715HA	Unfinished

Zinc Die Cast with Hook

**CROSSLY**

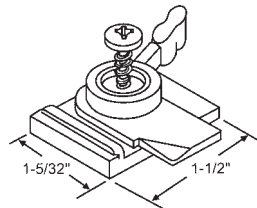

Part #	Hand	Finish
50-619RHA	Shown	White
50-619LHA	Opposite	White

Plastic

**THERMALGARD**

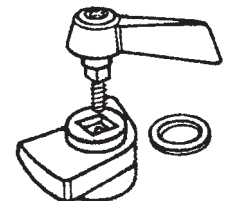

Part #	Finish
50-1127	Black

Slider Latch. Short

**HARCAR**

# WINDOW REPLACEMENT HARDWARE

## SWEEP LOCKS & SASH LOCKS

3/4"

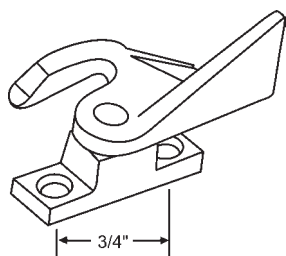

Part #	Finish
50-610	Unfinished

Zinc Die Cast. Use with 50-611 Keeper.

**PORTALUME**

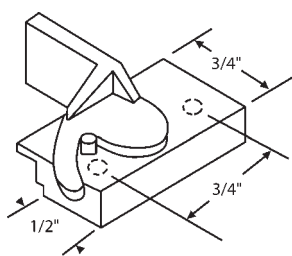

Part #	Hand	Finish
50-705	Shown	Unfinished
50-704	Opposite	Unfinished

Zinc Die Cast  
**CROSSLY**

7/8"

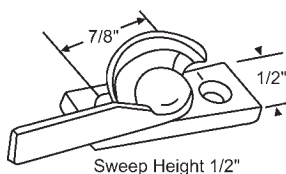

Part #	Hand	Finish
50-637	Shown	Brite
50-638	Opposite	Brite
50-637BR	Shown	Bronze

Zinc Die Cast. Use with 50-643 Keeper.  
**STANLEY**

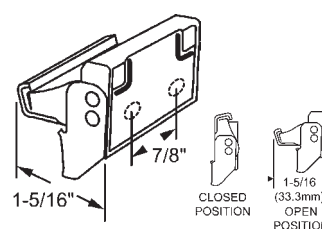

Part #	Finish
50-355-1	Bronze
50-355-2	Gold
50-355-3	White
50-355-10	Black

Check Rail Lock

1"

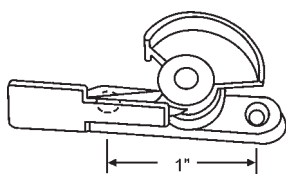

Part #	Finish
50-711	Unfinished

Zinc Die Cast. Use with 50-701 Keeper.

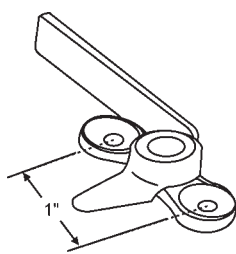

Part #	Finish
900-41WB	White Bronze

Bronze Casting  
**UALCO**

1-1/4"

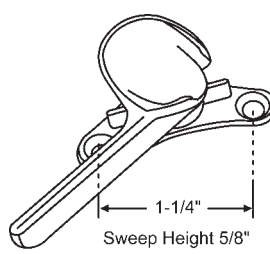

Part #	Finish
50-641	Brite

Zinc Die Cast. Use with 50-790 Keeper.

**KINCO**

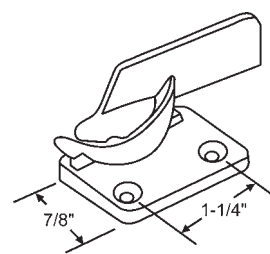

Part #	Finish
50-645	Brite

Zinc Die Cast. Use with 50-646 Keeper.

**SEASONALL**

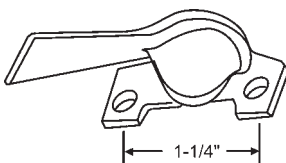

Sash Lock and Keeper

Part #	Finish
50-608A	White Bronze

Sash Lock Only

Part #	Finish
50-651	White Bronze

Bronze Casting. Use with 50-609WB Keeper.

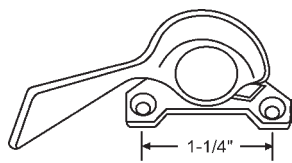

Sweep Height 7/16"

Part #	Finish
50-671	White Bronze

Bronze Casting  
Use with 900-8505 Keeper.

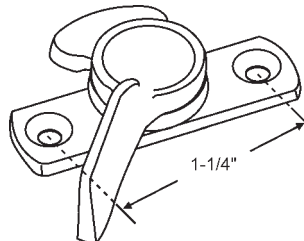

Part #	Finish
50-678	Brite

Die Cast  
**RUSCO**

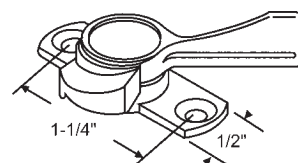

Part #	Finish
50-783B	Black

Height Graduates from 9/32" to 3/8" Max.  
Zinc Die Cast  
**RUSCO**

1-5/16"

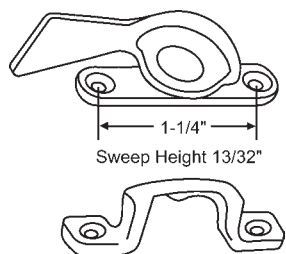

Sweep Height 13/32"

Part #	Finish
50-655A	White Bronze

Bronze Casting. Includes Keeper

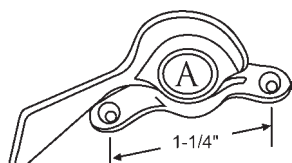

Sweep Height 13/32"

Sash Lock and Keeper

Part #	Finish
50-718A	White Bronze

Sash Lock Only

Part #	Finish
50-718	White Bronze

Bronze Casting. Use with 50-709 Keeper.

**ALWINSEAL**

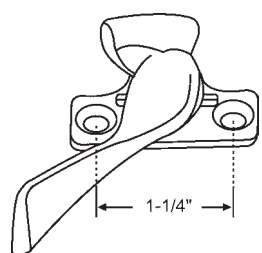

Part #	Finish
900-7267	White Bronze

Bronze Casting  
**WINDOW MASTER**

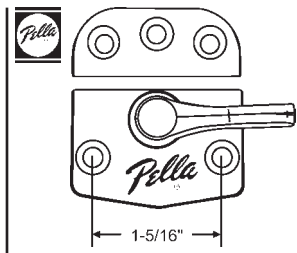

Part #	Finish
50-233	Copperite
50-233CHP	Champagne

Zinc Die Cast. With Keeper and Shim

# WINDOW REPLACEMENT HARDWARE

## SWEEP LOCKS & SASH LOCKS

In order by mounting hole width (single hole locks first).

1-3/8"

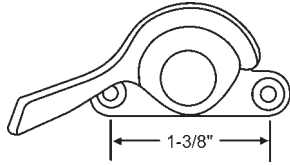

Part #
900-8503X

Zinc Die Cast. Sweep Height 7/16"  
White Bronze Look

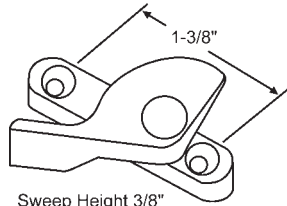

Part #	Finish
50-698	Unfinished

Zinc Die Cast

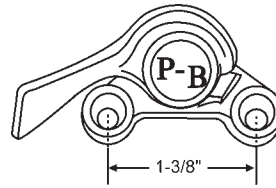

Part #	Finish
900-9158	White Bronze

Bronze Casting. Sweep Height 3/8"

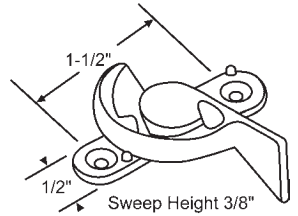

Part #	Finish
50-607	Unfinished

Zinc Die Cast  
**KELLER**

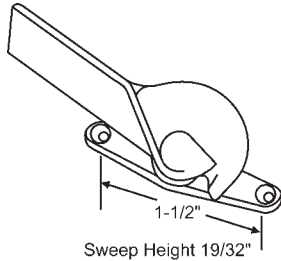

Part #	Hand	Finish
50-614	Shown	Brite
50-614RH	Opposite	Brite

Zinc Die Cast  
**PAN AM**

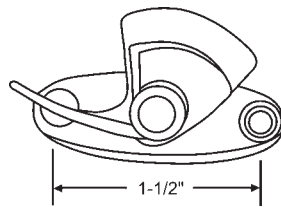

Part #	Finish
50-627	Brite
50-627B	Bronze

Zinc Die Cast  
**KELLER**

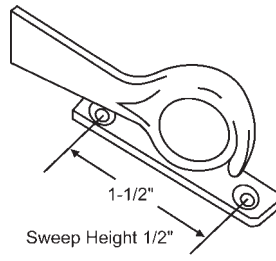

Part #	Finish
50-654	White Bronze

Bronze Casting  
Use with 900-9151 Keeper.

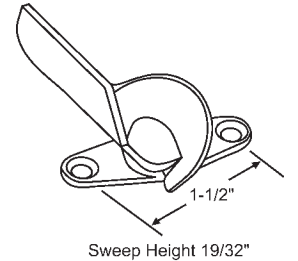

Part #	Finish
50-662	Brite

Zinc Die Cast

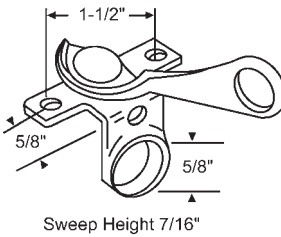

Part #	Finish
50-653	White Bronze

Bronze Casting

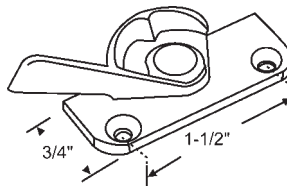

Part #	Finish
900-40	Unfinished

Zinc Die Cast  
**UALCO**

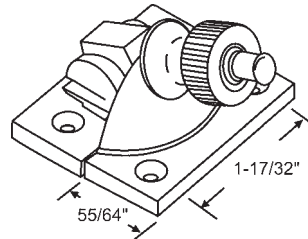

Part #	Finish
50-1096BRS	Polished Brass
50-1096CH	Chrome Plated

Brighton Style Sash Lock and Keeper.  
Spring Action. Solid Cast Brass

**MIGHTON**

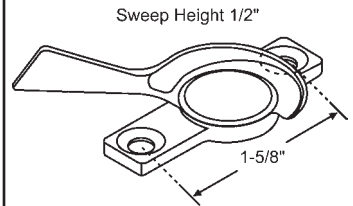

Part #	Finish
50-689	White Bronze

Bronze Casting. Use with 50-690 Keeper

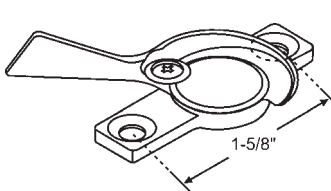

Part #	Finish
50-689S	White Bronze

with Security Screw

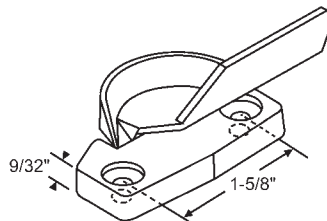

Part #	Hand	Finish
900-10803LH	Shown	Brite
900-10803RH	Opposite	Brite

Zinc Die Cast. Use with 50-800 Keeper.  
**NUPRIME/SEASONALL**

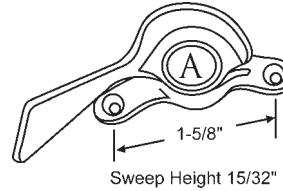

Part #	Finish
50-710	White Bronze

Bronze Casting. Use with 50-709 Keeper.

**ALWINSEAL**

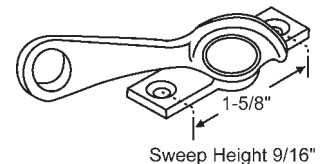

Part #	Hand	Finish
900-6706	Shown	White Bronze

Bronze Casting. Sweep Height 9/16"

**TRACO**

# WINDOW REPLACEMENT HARDWARE

## SWEEP LOCKS & SASH LOCKS

1-21/32"

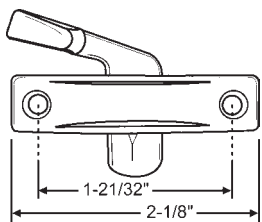

Part #	Finish
50-849B	Black

Zinc Die Cast. Screws #70605B

1-3/4"

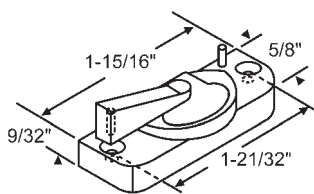

Sweep Height 15/32"

Part #	Finish
50-863	Unfinished

Zinc Die Cast  
**AMCO**

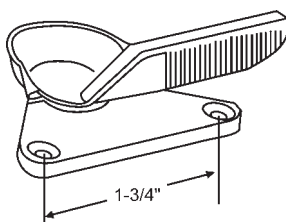

Part #	Hand	Finish
50-612-30R	Shown	Antique Copper
50-612-30L	Opposite	Antique Copper

Zinc Die Cast

**FIBERLUX/REMINGTON**

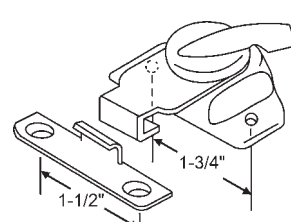

Part #	Finish
50-658A	Chrome Plated
50-658B	Brass Plated

Stamped Steel. Includes Keeper

1-13/16"

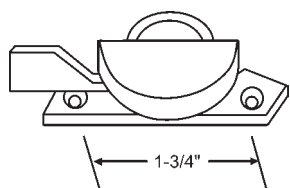

Part #	Finish
50-676	Brite

Zinc Die Cast. Use with 50-643 Keeper.

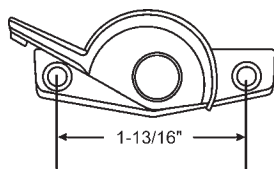

Part #	Finish
50-681	Black

Zinc Die Cast  
**CROFT**

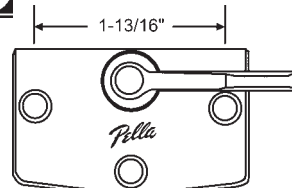

Part #	Finish
50-213CHP	Champagne
50-213BP	Brass Plated

Zinc Die Cast. Use with 50-363 Keeper.

1-7/8"

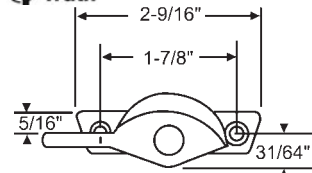

Sweep Height 1/2"

Part #	Finish
50-360-1	Bronze

Low Profile Cam Lock

Zinc Die Cast. Use with Keeper 50-361-1.

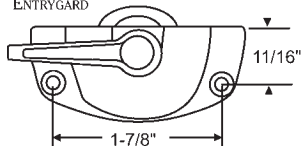

Part #	Finish
50-369-1	Bronze
50-369-3	White
50-369-28	Almond

Zinc Die Cast. Use with Keepers 50-374-Color and 50-372-Color.

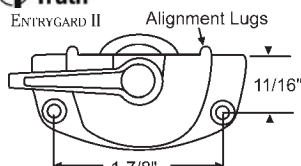

Part #	Finish
50-842-1	Bronze
50-842-3	White

Zinc Die Cast Use with Keepers 50-379-Color, 50-740-Color, 50-373-Color and 50-372-Color.

1-31/32"

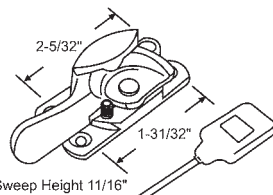

Sweep Height 11/16"

Security Sash Lock and Keeper

Part #	Finish
50-1100BRS	Solid Brass
50-1100CH	Chrome

Solid Cast Brass.

Part #	Description
50-1100SS	Stainless Steel

**MIGHTON**

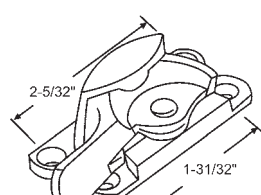

Sweep Height 11/16"

Part #	Finish
50-1099BRS	Solid Brass
50-1099CH	Chrome

Sash Lock and Keeper. Solid Cast Brass

**MIGHTON**

2"

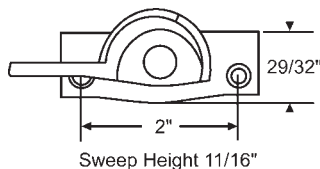

Sweep Height 11/16"

Part #	Finish
50-356-1	Bronze

Zinc Die Cast. Use w/Keeper 50-357-Color or Beveled Keeper 50-358-Color.



Part #	Finish
50-634A	Zinc Die Cast, Brass Plated
50-748	Solid Brass, Polished Brass

Includes Keeper

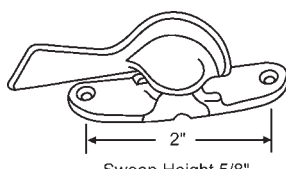

Sweep Height 5/8"

Part #	Finish
50-669	White Bronze

Bronze Casting

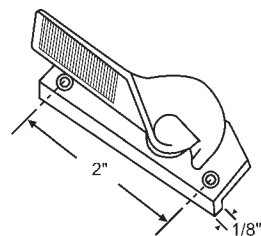

Sweep Height 9/16"

Part #	Finish
900-18881	White

Zinc Die Cast. Sweep Height 9/16"

# WINDOW REPLACEMENT HARDWARE

## SWEEP LOCKS & SASH LOCKS

In order by mounting hole width (single hole locks first).

2"

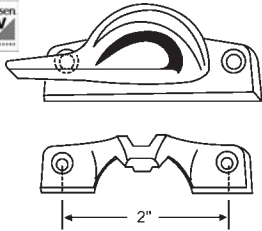

Sweep Height 15/32"

Part #	Finish
750-1630020	Stone

Old Style was Zinc Die Cast, New Style is Plastic. Includes Keeper and Screws.

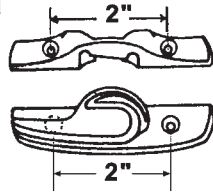

Part #	Finish
750-1630029	White

White Plastic Kit. Includes 1 Sash Lock, 1 Keeper, 2 Shims & Screws

2-1/16"

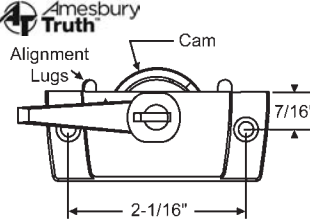

Part #	Finish
50-747-3	White

With Lugs. Comes with Two Keys

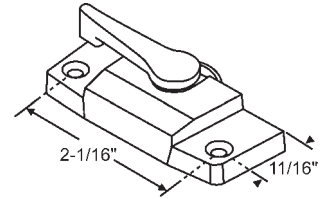

Part #	Finish
50-865B	Black
50-865W	White

Zinc Die Cast. Use with 50-896 Keeper. Standard Cam.

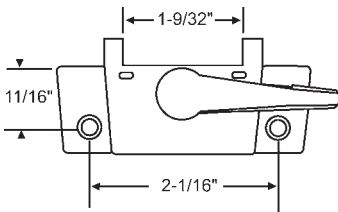

Part #	Finish
50-924-65	Terratone Brown
50-924-47	Bronze

Zinc Die Cast

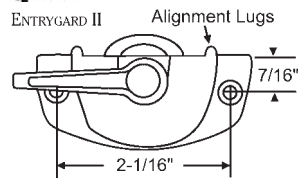

Part #	Finish
50-784-1	Bronze
50-784-3	White

Zinc Die Cast. Use with Keeper 50-379-Color, 50-372-Color and 50-373-Color.

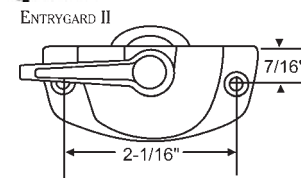

Part #	Finish
50-789-1	Bronze
50-789-3	White

Zinc Die Cast. Use with Keeper 50-374-Color and 50-372-Color.

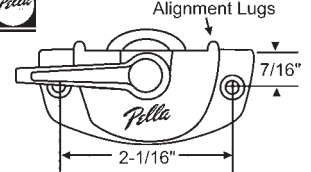

Part #	Finish
50-364-3P	White
50-364-35P	Champagne

Zinc Die Cast  
Use with Keeper 50-920-Color.

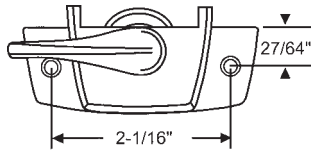

Part #	Finish
50-752W	White

Zinc Die Cast. Use with 50-753W Keeper.

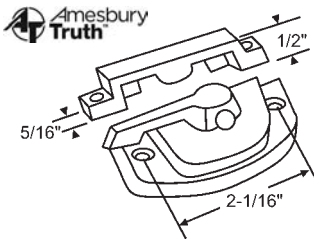

Part #	Finish
50-762	White

Push Button Security Lock  
Zinc Die Cast. Includes Keeper

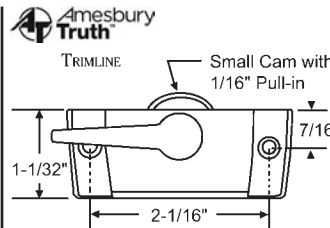

Part #	Finish
50-386-1	Bronze
50-386-3	White

Zinc Die Cast

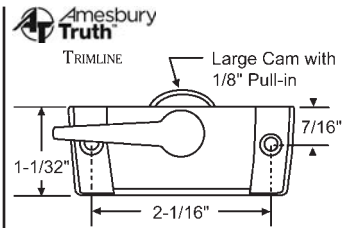

Part #	Finish
50-384-1	Bronze
50-384-2	Gold
50-384-3	White

Zinc Die Cast

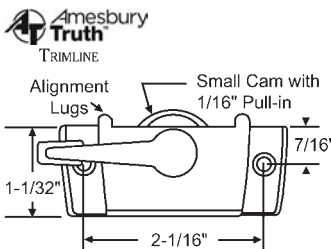

Part #	Finish
50-382-3	White

Zinc Die Cast. Use with 50-392-3 Keeper.

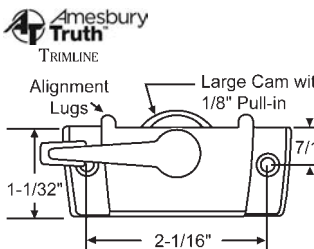

Part #	Finish
50-380-3	White
50-380-6	Clay
50-380-8	Chestnut Bronze

Zinc Die Cast. Use with 50-392 and 50-393 Keepers.

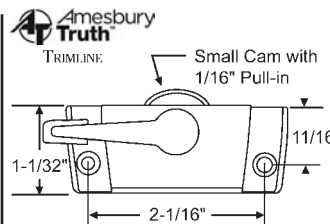

Part #	Finish
50-385-1	Bronze
50-385-3	White

Zinc Die Cast

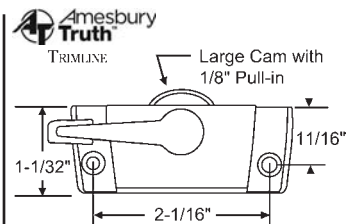

Part #	Finish
50-387-3	White
50-387-5	Polished Brass
50-387-6	Clay

Used with 50-387K Keeper

# WINDOW REPLACEMENT HARDWARE

## SWEEP LOCKS & SASH LOCKS

2-1/16"

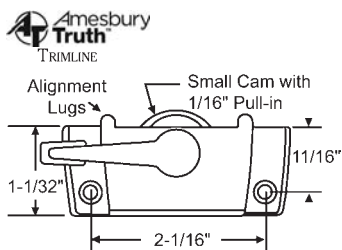

Part #	Finish
50-381-3	White
50-381-8	Chestnut Bronze

Zinc Die Cast. Use with 50-392 and 50-393 Keepers.

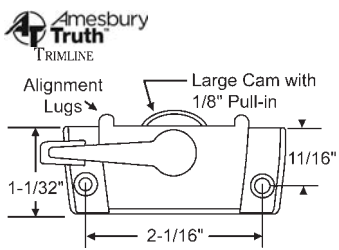

Part #	Finish
50-383-3	White
50-383-4	Coppertone
50-383-6	Clay
50-383-9	Beige

Zinc Die Cast. Use with 50-392 and 50-393 Keeper.

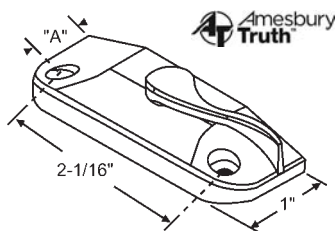

Part #	Finish	"A"
50-939-46	Appliance White	11/16"
50-940-46	Appliance White	7/16"

Zinc Die Cast. Use with 50-1112-46 Keeper.

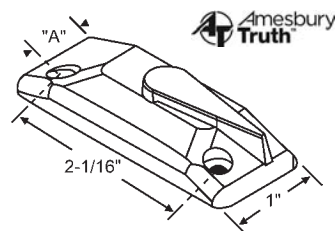

Part #	Finish	"A"
50-937-3	White	7/16"
50-938-46	Appliance White	11/16"

Zinc Die Cast. Use with 50-1109-3 and 50-1112-46 Keeper.

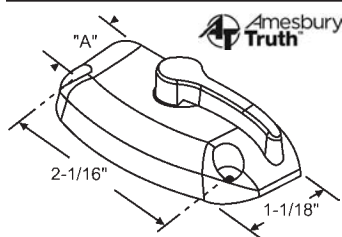

Part #	Finish	"A"
50-941-46	Appliance White	7/16"
50-942-46	Appliance White	11/16"

Zinc Die Cast. Use with 50-1110-46 and 50-1111-46 Keeper.

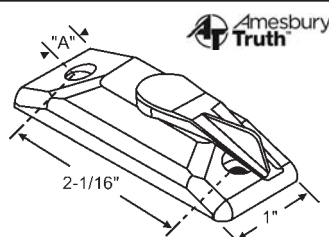

Part #	Finish	"A"
50-943-46	Appliance White	7/16"
50-944-46	Appliance White	11/16"

Zinc Die Cast. Use with 50-1109-46 Keeper.

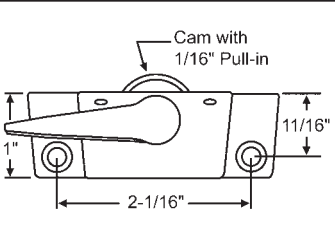

Part #	Finish
50-419-10X	Black

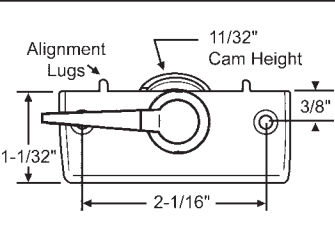

Part #	Finish
50-868	Driftwood

Zinc Die Cast. Use with 50-868K Keeper.  
**PEACHTREE**

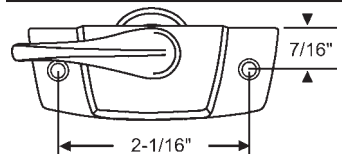

Part #	Finish
50-1016OW	Off-White
50-1016OW-Homepride	Off-White (Homepride stamped on front)
50-1016OW-Interstate	Off-White (Interstate stamped on front)
50-1016AD	Almond
50-1016AD-Homepride	Almond (Homepride stamped on front)
50-1016BP	Brass Plated



Part #	Finish
50-471-1	Bronze
50-471-5	Polished Brass
50-471-71	Oil-Rubbed Bronze

Restoration Locks. Zinc Die Cast. Use with 50-472-Color Keeper.

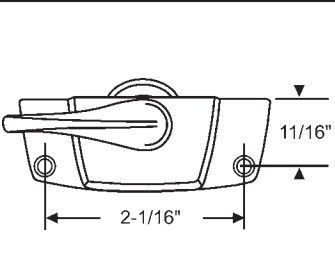

Part #	Finish
50-1019OW	Off-White
50-1019AD	Almond

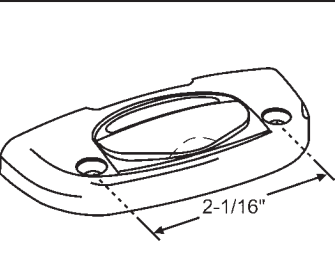

Part #	Finish
50-1065W	White

Used with 50-1066W & 50-1067W Keepers

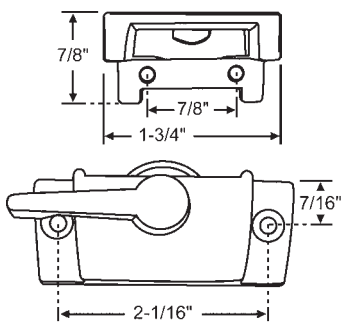

Part #	Finish
50-1181BG	Beige

Sash Lock and Keeper Set



Part #	Finish
50-439ORBZ	Oil Rubbed Bronze
50-439PNK	Polished Nickel

Fitch Pattern Sash Lock Set  
Base Dimensions: 9/16" x 2-1/8"  
Strike Dimensions: 7/16" x 2-1/8"

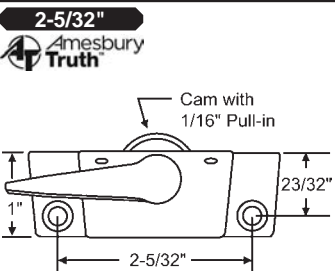

Part #	Finish
50-429-46X	Appliance White

Zinc Die Cast. Use with 900-21122 Keeper.

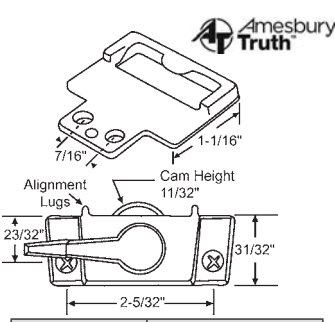

Part #	Finish
900-14379BGA	Beige

Zinc Die Cast. Includes Keeper  
**FIBERLUX**



# WINDOW REPLACEMENT HARDWARE

## SWEEP LOCKS & SASH LOCKS

In order by mounting hole width (single hole locks first).

**2-3/16"**

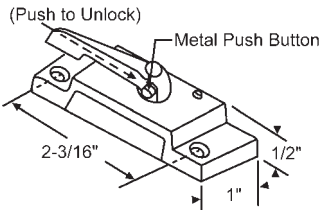

Part #	Finish
50-415-10	Black
50-415-3	White

Zinc Die Cast

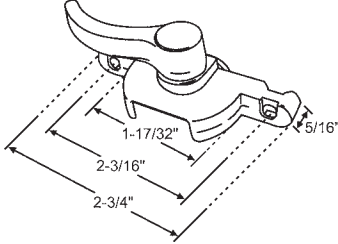

Part #	Finish
50-409-3	White

**2-7/32"**

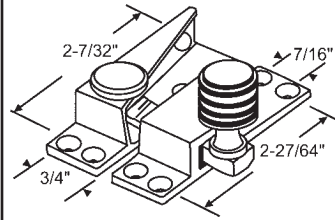

Part #	Finish
50-1098BRS	Brass

Sash Lock and Keeper. Solid Cast Brass

**MIGHTON**

**2-1/4"**

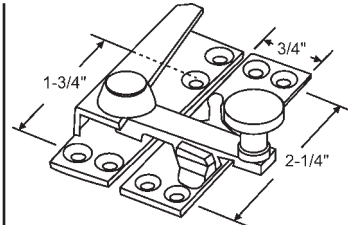

Part #	Finish
50-1097BRS	Solid Brass
50-1097CH	Chrome

Solid Cast Brass

**MIGHTON**

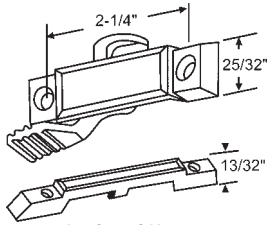

Lock and Keeper

Part #	Finish
50-601A	Chrome
50-601WA	White
50-601BA	Black

Sweep Lock Only

Part #	Finish
50-601-55	Metallic Gold
50-601-8	Dark Bronze

Zinc Die Cast

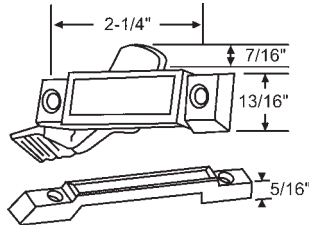

Lock and Keeper

Part #	Finish
50-603A	Chrome
50-603BA	Black
50-603WA	White

Zinc Die Cast

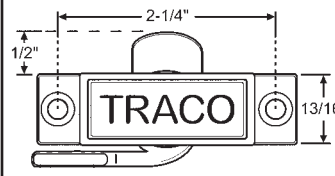

Part #	Finish
50-603BZ-500T	Bronze

With .500 Throw

**TRACO/SECURITY**

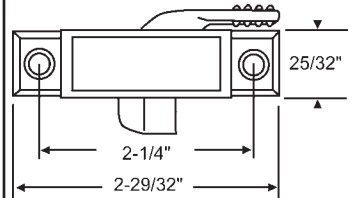

Part #	Hand	Finish
50-1064RHOW	Shown	Off-White

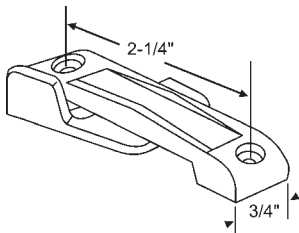

Part #	Finish
50-657B	Black

Zinc Die Cast

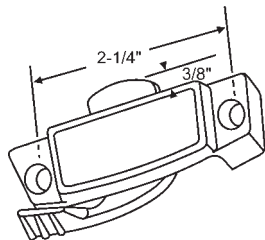

Part #	Finish
50-731B	Black

Zinc Die Cast. Use with 50-602 Keeper.

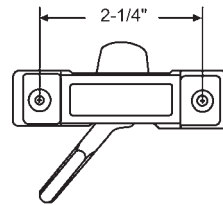

Part #	Finish
900-7903	White Bronze
900-7903P (w/pole hole)	White Bronze

Bronze Casting

**SEASONALL**

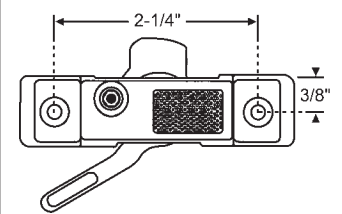

Part #	Finish
50-1205	White Bronze

Includes Set Screw

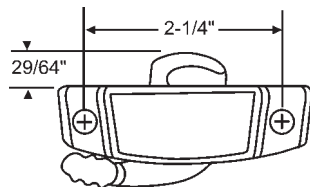

Part #	Finish
900-11005B	Black

Zinc Die Cast. Use with 900-14381 Keeper.

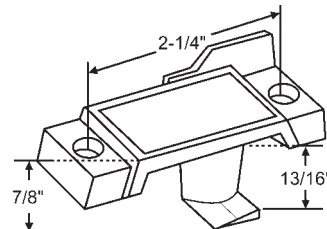

Part #	Finish
50-765	White
50-765B	Black

**ACORN**

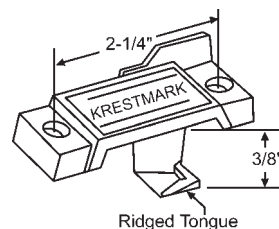

Part #	Finish
900-10798KB	Black

Zinc Die Cast

**KRESTMARK**

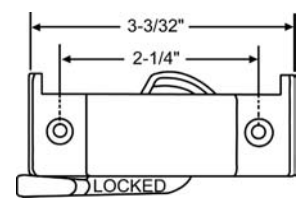

Part #	Finish
900-19656B	Black

Zinc Die Cast. Use with 900-19705 Keeper.

# WINDOW REPLACEMENT HARDWARE

## SWEEP LOCKS & SASH LOCKS

2-1/4"

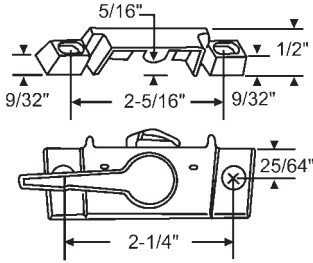

Part #	Finish
50-827-45	Blue White
50-827-70	Dark Brown

Zinc Die Cast. Includes Keeper

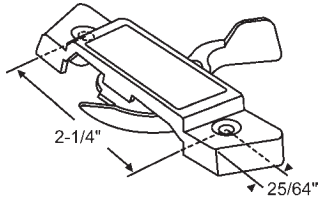

Part #	Hand	Finish
900-19112LH	Shown	Black
900-19112RH	Opposite	Black

Zinc Die Cast  
**RUSCO**

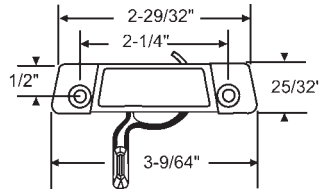

Part #	Hand	Finish
50-971-40RH	Shown	Snow White
50-971-40LH	Opposite	Snow White
50-971-9RH	Shown	Beige
50-971-9LH	Opposite	Beige

Zinc die Cast  
**MI HOME PRODUCTS**

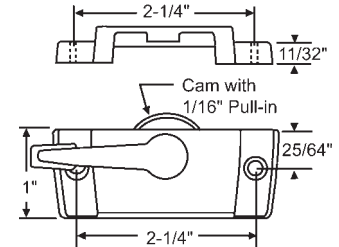

Part #	Finish
50-418-10	Black
50-418-46	Blue White

Zinc Die Cast. Includes Keeper

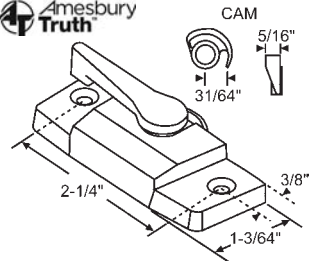

Part #	Finish
900-19228BG	Beige

Zinc Die Cast. Use with 900-20118 Face Mount Keeper.

**TRACO/ROLLYSON**

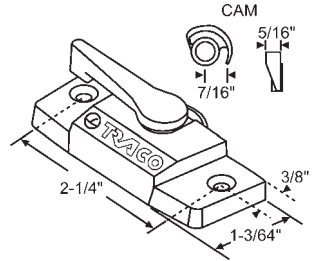

Part #	Finish
900-19778	Black

Zinc Die Cast.  
**TRACO**

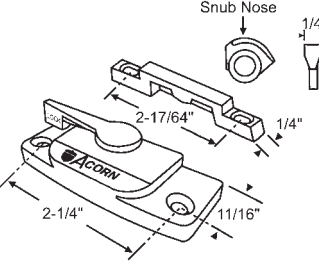

Part #	Finish
50-915	White

Includes Keeper  
**ACORN**

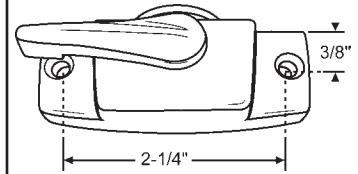

Part #	Finish
50-1027W	White
50-1027B	Black

**TRACO 5000**

2-3/8"

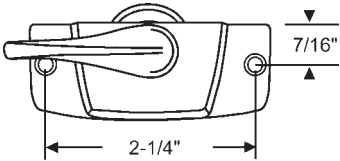

Part #	Finish
50-1022BP	Brass Plated

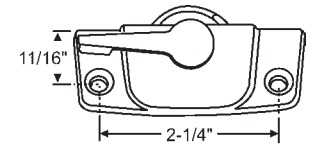

Part #	Finish
50-970B	Black

Zinc Die Cast. Sweep Height 5/16". Use with 50-970KB Keeper.

**ACORN**

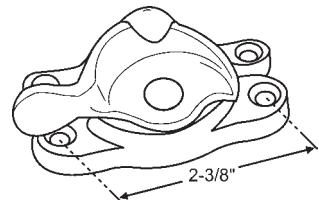

Part #	Finish
50-440	Lacquered Polished Brass
50-440ORBZ	Oil-Rubbed Bronze
50-440PNK	Polished Nickel
50-440SNK	Satin Nickel

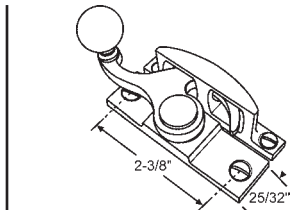

Part #	Finish
50-1323ORBZ	Oil Rubbed Bronze
50-1323PB	Polished Brass
50-1323PNK	Polished Nickel
50-1323SNK	Satin Nickel

2-9/16"

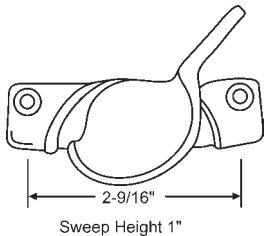

Part #	Finish
900-7858	Copper

Bronze Casting  
Use with 900-7859 Keeper.

2-9/16"

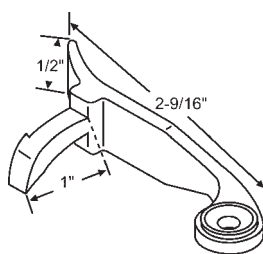

Part #	Finish
900-11288	Chrome

Zinc Die Cast  
**MODULUME**

2-5/8"

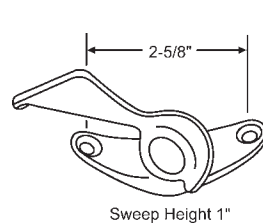

Part #	Finish
50-723	White Bronze

Bronze Casting

2-7/8"

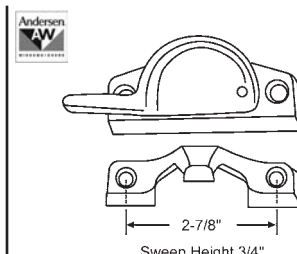

Part #	Finish
750-1630108	Stone

Sash Lock Set (2 Locks, 2 Keepers). Old Style was Zinc Die Cast, New Style is Plastic.

# WINDOW REPLACEMENT HARDWARE

## DOUBLE HUNG LATCH

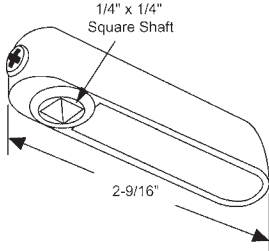

Part #	Finish
900-21337-BG	Driftwood
900-21337-W	White

Double Hung Latch. Plastic  
**PEACHTREE**

## STAMPED STEEL FACE MOUNTED WINDOW KEEPERS

Stamped steel keepers in order by mounting hole distance and height.

### Single Hole

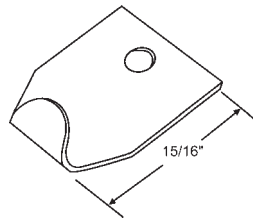

Part #	Finish
50-712SP	Stamped Steel

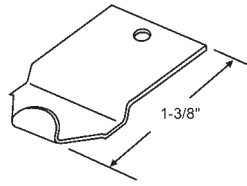

Part #	Finish
50-692	Stamped Steel

### 7/16"

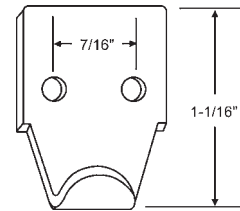

Part #	Finish
50-661	Stamped Steel

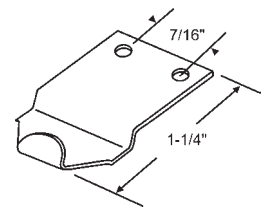

Part #	Finish
50-691	Stamped Steel

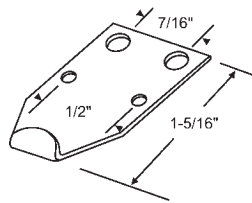

Part #	Finish
50-694	Stamped Steel

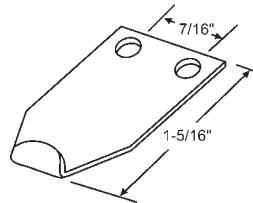

Part #	Finish
50-697	Stamped Steel

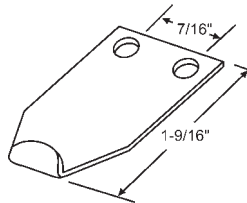

Part #	Finish
900-9744	Stamped Steel
900-9744W	White

### 15/32"

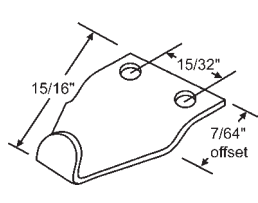

Part #	Finish
50-700	Stamped Steel

### 1/2"

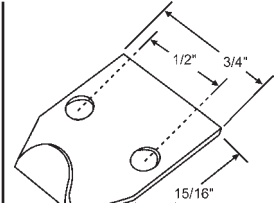

Part #	Finish
900-8359	Stamped Steel

**BINNINGS**

## HUNG & SLIDING FACE MOUNTED WINDOW KEEPERS

Face mounted keepers in order by mounting hole distance and height.

### 5/8"

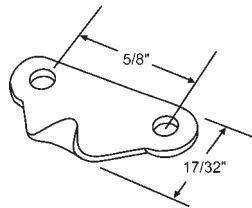

Part #	Finish
50-663	Stamped Steel

### 1-1/4"

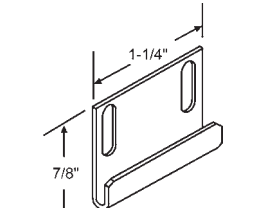

Part #	Finish
50-790	Stamped Steel

### Single Hole

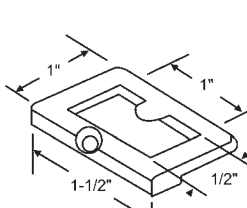

Part #	Finish
50-650	Chrome

Zinc Die Cast

### 7/16"

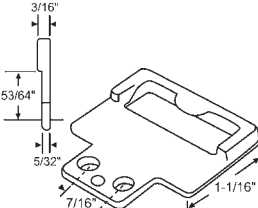

Part #	Finish
900-18531BG	Almond
900-18531BK	Black

Zinc Die Cast

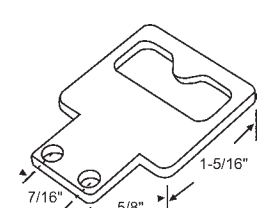

Part #	Finish
900-18880	Antique Copper

Zinc Die Cast

### 1/2"

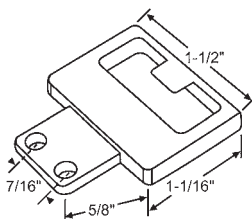

Part #	Finish
50-775-3	White
50-775-30	Antique Copper
50-775-12	Dayton Brown

Zinc Die Cast

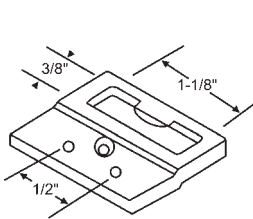

Part #	Finish
50-696	Chrome

Zinc Die Cast

### 5/8"

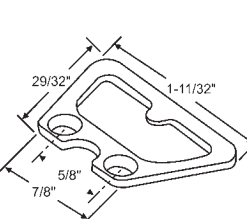

Part #	Finish
900-9920	White Bronze

Bronze Casting

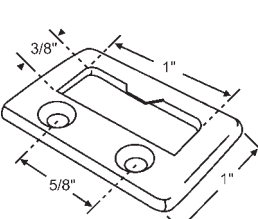

Part #	Finish
50-643	Brite

Zinc Die Cast

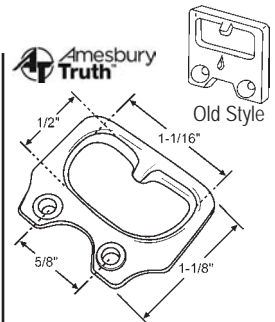

Part #	Finish
50-609WB	White Bronze

New Style  
**NORANDEX**

# WINDOW REPLACEMENT HARDWARE

## STAMPED STEEL FACE MOUNTED WINDOW KEEPERS

11/16"

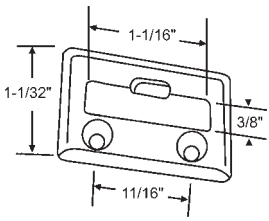

Part #	Finish
50-642	Brite
Zinc Die Cast	

3/4"

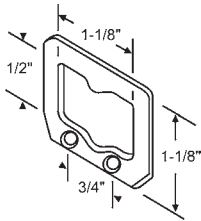

Part #	Finish
50-709	White Bronze
Bronze Casting	

25/32"

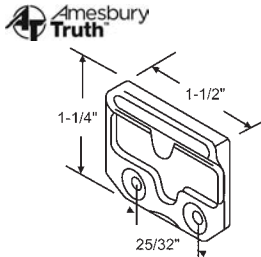

Part #	Finish
50-733K	Brite
Zinc Die Cast	

7/8"

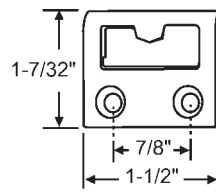

Part #	Finish
50-970KB	Black
Zinc Die Cast	
<b>ACORN</b>	

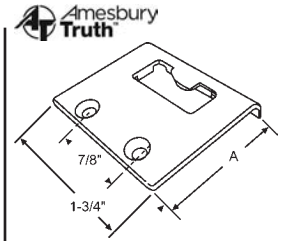

Part #	Finish	A
50-805W	White	1-1/2"
50-896W	White	1-3/16"
Zinc Die Cast		

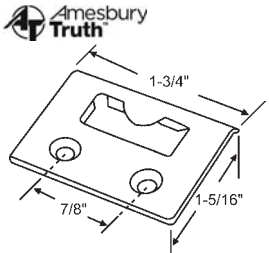

Part #	Finish
50-914-1	Bronze
50-914-9	Beige
Zinc Die Cast	

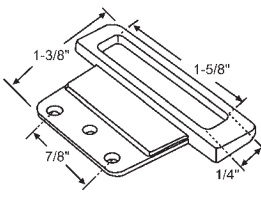

Part #	Finish
50-647	Chrome
Zinc Die Cast	
<b>SEASONALL</b>	

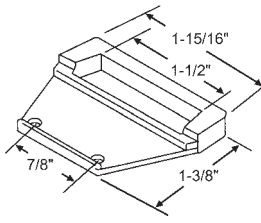

Part #	Finish
900-20101	Chrome
Zinc Die Cast	
<b>SEASONALL</b>	

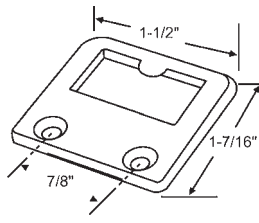

Part #	Finish
50-1004	Brite
Zinc Die Cast	
<b>PAN AM</b>	

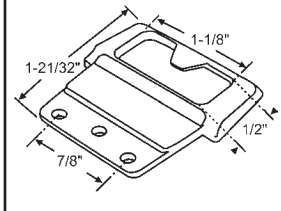

Part #	Finish
50-646	Chrome
Zinc Die Cast	
<b>SEASONALL</b>	

1"

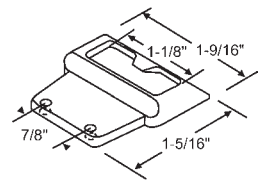

Part #	Finish
50-800	Satin Aluminum
Zinc Die Cast	
<b>BETTER-BILT</b>	

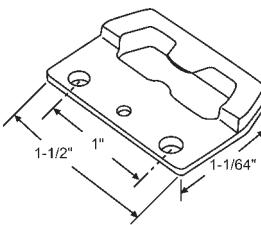

Part #	Finish
50-753W	White
Zinc Die Cast	

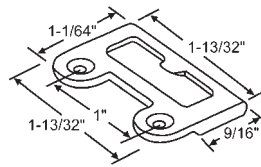

Part #	Finish
900-9929	White Bronze
Bronze Casting	

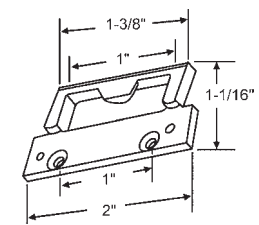

Part #	Finish
50-804BG	Beige
50-804W	White
Zinc Die Cast	
<b>ROLLYSON</b>	

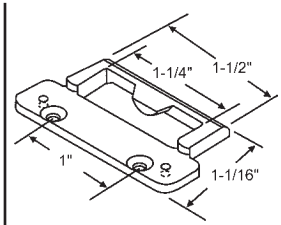

Part #	Finish
900-20118	White
Zinc Die Cast	
<b>ROLLYSON</b>	

1-1/8"

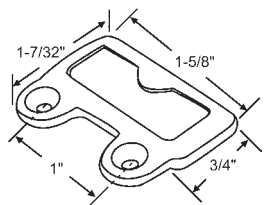

Part #	Finish
900-13581	White Bronze
Bronze Casting	

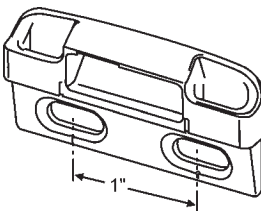

Part #	Finish
50-1067W	White
Used with 50-1065W Sash Lock	
<b>INTERLOCK</b>	

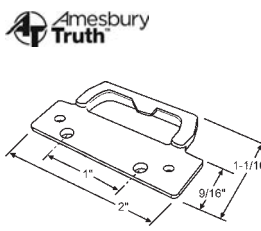

Part #	Finish
900-19782B	Brown
900-19782BG	Beige
900-19782W	Appliance White

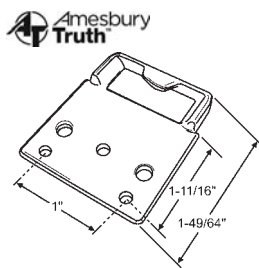

Part #	Finish
50-495-3	White

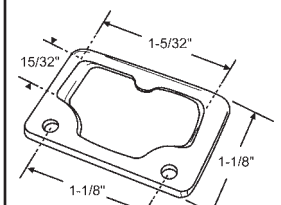

Part #	Finish
50-946	White Bronze

# WINDOW REPLACEMENT HARDWARE

## HUNG & SLIDING FACE MOUNTED WINDOW KEEPERS

Face mounted keepers in order by mounting hole distance and height.

1-3/8"

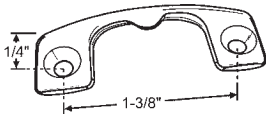

Part #	Finish
900-11333	White Bronze

1-7/16"

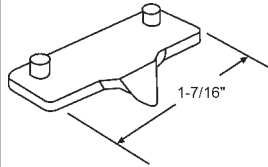

Part #	Finish
50-623	Unfinished

Zinc Die Cast  
**AIR CONTROL**

1-1/2"

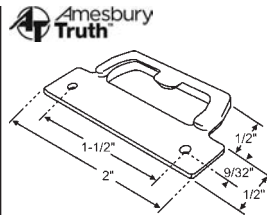

Part #	Finish
900-18551KWT	Snow Blue

1-21/32"

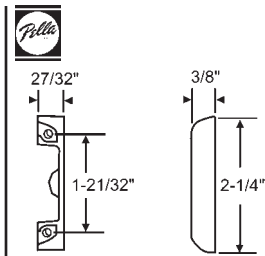

Part #	Finish
50-363-35P	Champagne

Used with 50-213CHP Sash Lock

2-1/16"

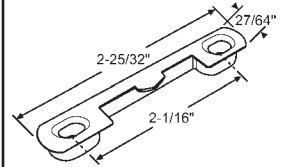

Part #	Finish
50-1404W	White

**PGT**

2-1/4"

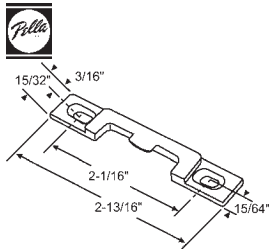

Part #	Finish
50-489-3	White

Vinyl

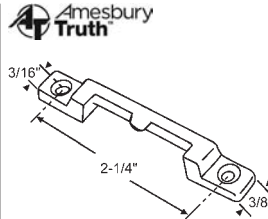

Part #	Finish
50-749	White

Zinc Die Cast

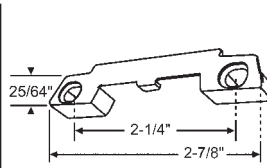

**50-1076OW**  
Off White

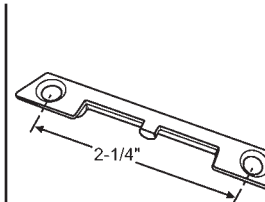

**900-11293-9**  
Beige  
**PGT**

2-5/16"

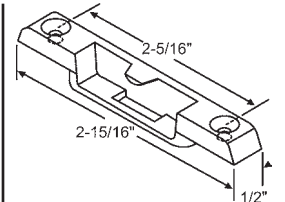

Part #	Finish
50-895	White

Plastic  
**METAL INDUSTRIES**

## HUNG & SLIDING TOP MOUNTED KEEPERS

In order by mounting hole distance and height.

1/2"

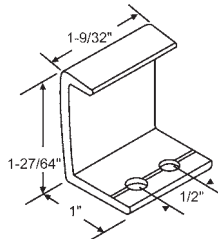

Part #	Finish
900-18719	Brown

Zinc Die Cast  
**TRACO**

3/4"

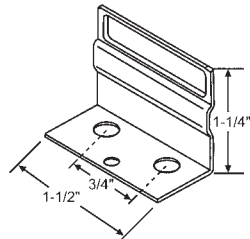

Part #	Finish
900-8728	Aluminum

**THERMALGARD**

1"

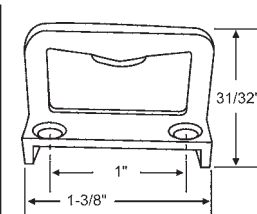

Part #	Finish
50-699	Unfinished

Zinc Die Cast

1-1/16"

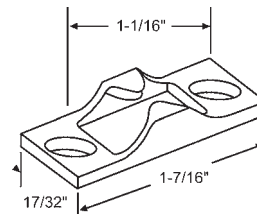

Part #	Finish
50-701	Die Cast

1-1/8"

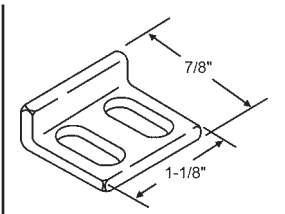

Part #	Finish
50-736	White Bronze

Bronze Casting  
**SWS**

1-11/32"

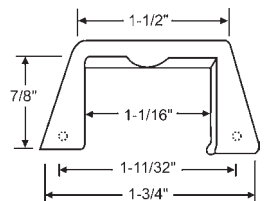

Part #	Finish
50-639	Chrome

Zinc Die Cast  
**ALENCO**

1-3/8"

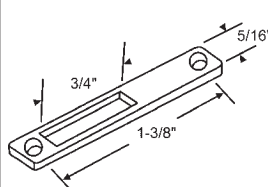

Part #	Finish
50-716	Chrome

Zinc Die Cast  
**CROSSLY**

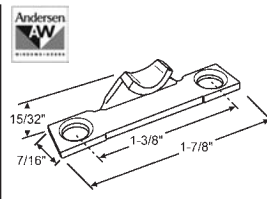

Part #	Finish
750-1361406	Stone
750-1351340	White

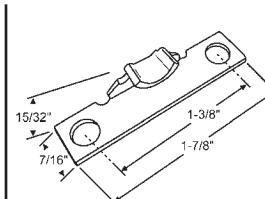

Part #	Finish
50-911K	Beige

1-5/8"

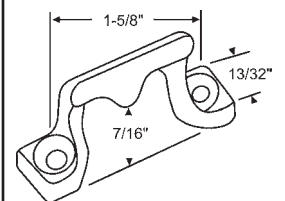

Part #	Finish
50-690	White Bronze

Bronze Casting

# WINDOW REPLACEMENT HARDWARE

## HUNG & SLIDING TOP MOUNTED WINDOW KEEPERS

In order by mounting hole distance and height.

1-5/8"

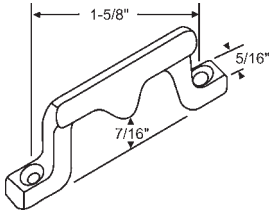

Part #	Finish
900-12561	White Bronze

Bronze Casting

1-7/8"

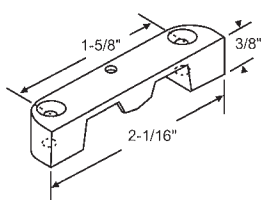

Part #	Finish
50-801K	Bright Brass

Zinc Die Cast

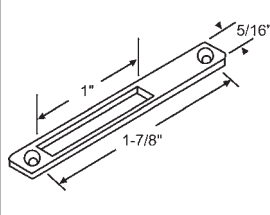

Part #	Finish
50-611	Chrome

Zinc Die Cast  
**PORTALUME**

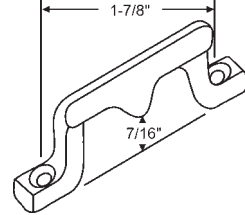

Part #	Finish
50-724	White Bronze

Bronze Casting

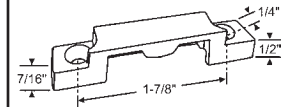

Part #	Finish
50-214-46	White
50-214-47	Bronze
50-214-50	Tan

1-51/64"

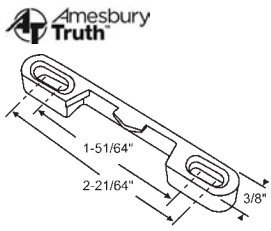

Part #	Finish
50-968-46	White

Zinc Die Cast

1-27/32"

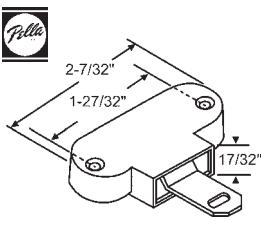

Part #	Finish
50-832	Beige

Sash Catch  
Plastic with Steel Tongue

2"

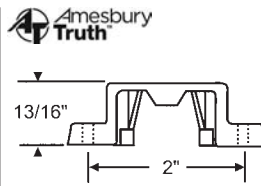

Part #	Finish
50-357-3	White
50-357-1	Bronze

2-1/16"

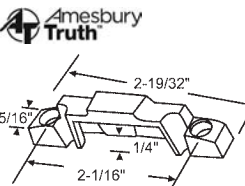

Part #	Finish
50-373-3	White
50-373-5	Bright Brass

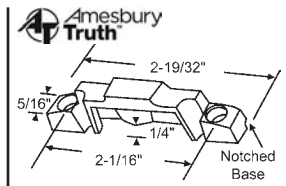

Part #	Finish
50-372-1	Bronze
50-372-3	White
50-372-5	Bright Brass
50-372-6	Clay
50-372-9	Beige

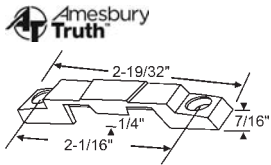

Part #	Finish
50-374-1	Bronze
50-374-3	White

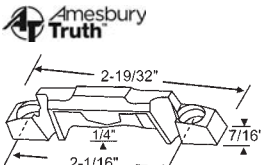

Part #	Finish
50-379-1	Bronze
50-379-3	White
50-379-8	Chestnut Bronze

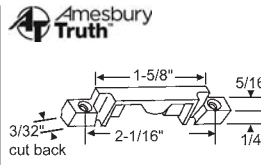

Part #	Finish
50-393-3	White
50-393-9	Beige
50-393-4	Coppertone
50-393-8	Chestnut Bronze

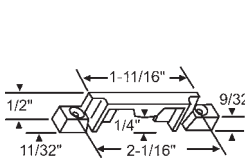

Part #	Finish
50-855	Bronze
50-855BE	Beige
50-855W	White

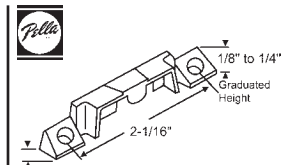

Part #	Finish
50-920-35	Champagne
50-920-3	White

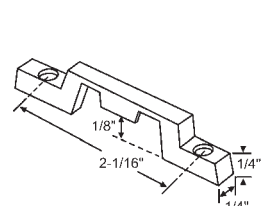

Part #	Finish
50-1033BP	Bras Plated
50-1033BZ	Bronze

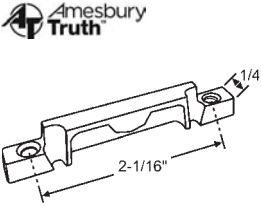

Part #	Finish
50-812-3	White
50-812-4	Coppertone

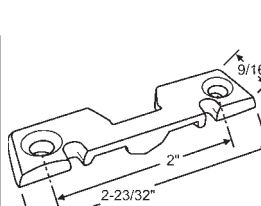

Part #	Finish
50-868K	Driftwood
50-868KW	White

Latch Keeper Kit. Includes 1 Keeper w/ Screws  
**PEACHTREE**

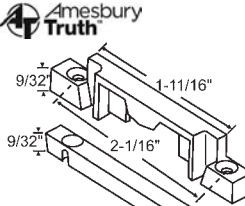

Part #	Finish
900-20056	Beige
900-20056W	White

Includes Shim 900-20103BE (Beige) or 900-20103W (White)

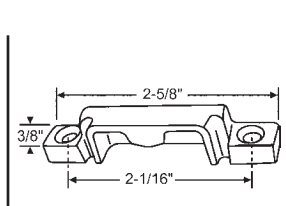

Part #	Finish
50-387-5K	Brass
50-387-6K	Clay
50-387-74K	Snow White

# WINDOW REPLACEMENT HARDWARE

## HUNG & SLIDING TOP MOUNTED WINDOW KEEPERS

In order by mounting hole distance and height.

2-1/16"

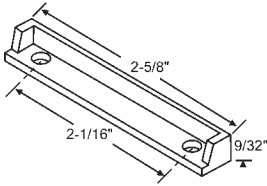

Part #	Finish
900-20045W	White
900-20045B	Black

Keeper Shim  
**BETTER-BILT**

2-1/8"

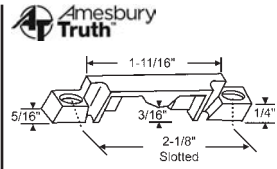

Part #	Finish
50-392-3	White
50-392-1	Bronze
50-392-14	Cocoa Brown
50-392-8	Chestnut Bronze
50-392-6	Clay

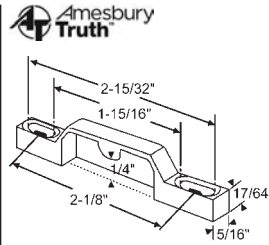

Part #	Finish
900-21122	White
900-21122-65	Brown
900-21122BG	Beige

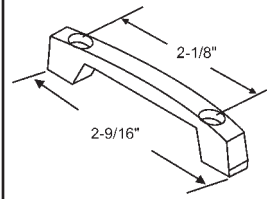

Part #	Finish
900-14377KB	Black

**SYN-TECH**

2-1/4"

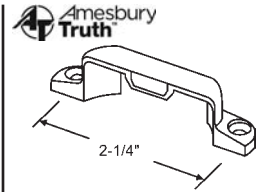

Part #	Finish
50-472-1	Bronze
50-472-5	Polished Brass
50-472-71	Oil-Rubbed Bronze

Keeper. Zinc Die Cast.  
Screws not Included.

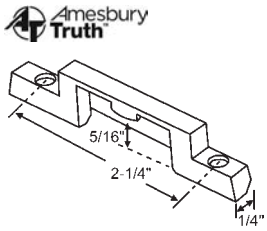

Part #	Finish
900-21121	Black

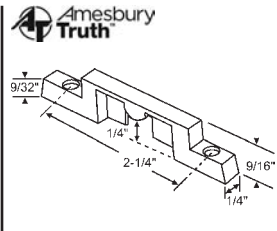

Part #	Finish
900-21375	White

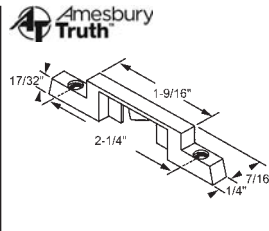

Part #	Finish
900-19229BG	Beige
900-19229AB	Antique Brass
900-19229BZ	Bronze

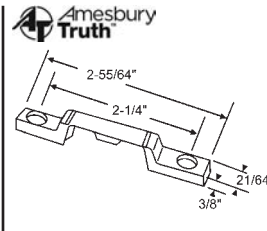

Part #	Finish
900-18601	Pewter

**TRACO**

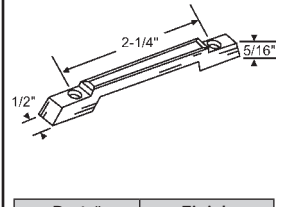

Part #	Finish
50-602	Chrome
50-602B	Black
50-602W	White
50-602CP	Antique Copper

2-3/8"

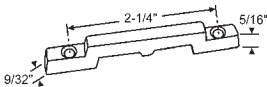

Part #	Finish
900-14381B	Black

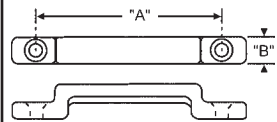

Part #	A	B
50-1206	2-1/4"	5/16"
900-22425	2-1/4"	1/4"



**50-1215-55**  
Metallic Gold  
Snug-Fit

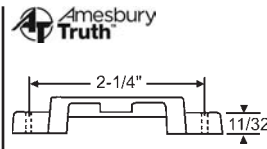

Part #	Finish
50-418-10K	Black
50-418-45K	Blue White
50-418-46K	Appliance White

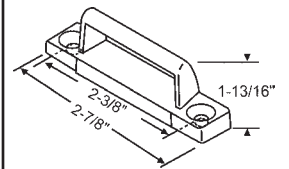

Part #	Finish
50-802	Satin Aluminum

**NU-PRIME**

2-7/16"

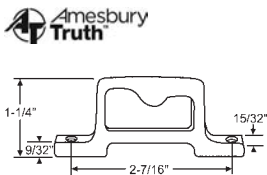

Part #	Finish
900-7859	Bronze

2-17/32"

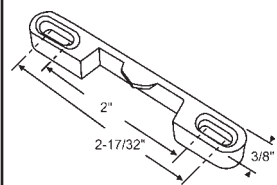

Part #	Finish
50-761-18	Sahara Beige
50-761-1	Bronze

2-3/4"

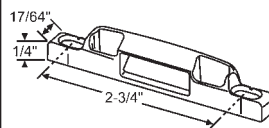

Part #	Finish
50-1066W	White

Used with 50-1065W Keeper  
**INTERLOCK**

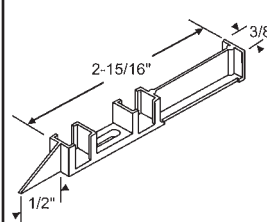

Part #	Finish
900-9562	Dichromate

**ACORN**

SLIDE LOCK

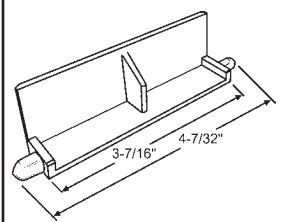

Part #	Finish
50-1194	Black

# WINDOW REPLACEMENT HARDWARE

## SPRING TYPE SLIDER LATCHES

Spring type latches in order by mounting hole distance and length.

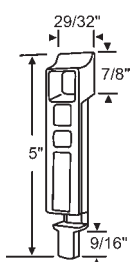

**900-8997**  
Black Lock Bolt  
**ACORN**

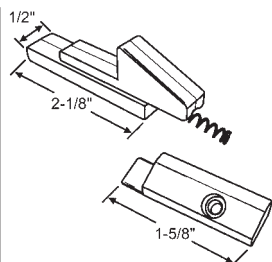

**50-956**  
Black. Sold in Set Only.  
Contains 2 Latches, 2 Keepers & 2 Springs.

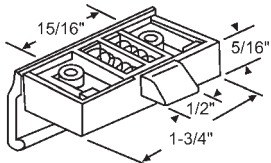

**50-600A**  
Plastic

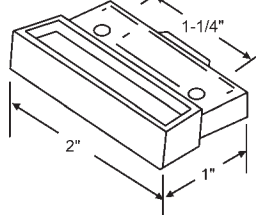

**50-688**  
Nylon

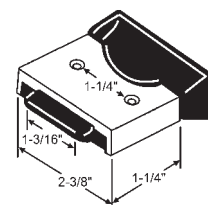

Part #	Finish
50-648A	Chrome and Black
50-648BEA	Chrome and Beige
50-648WHA	Chrome and White

Used with 50-647 Keeper.  
**SEASONALL**

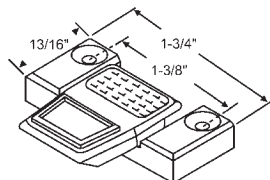

**900-9950**  
Die Cast

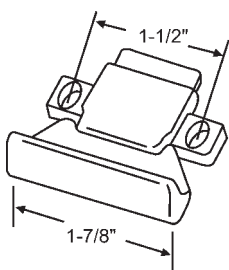

Part #	Finish
50-628A	Aluminum
50-628WA	White Aluminum

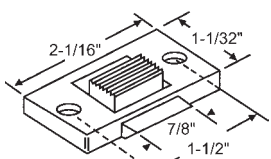

**50-730**  
Black Plastic

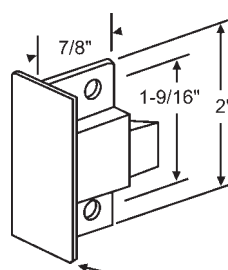

**50-1007**  
Black Die Cast

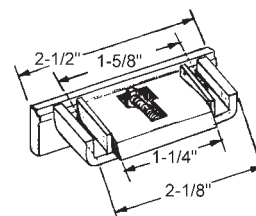

**900-9061**  
Black Die Cast

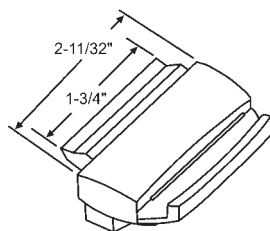

Part #	Finish
900-26	Bronze Lacquer
900-25	Chrome

Aluminum  
**CROSSLY**

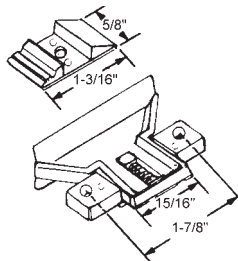

**900-8878**  
Black Die Cast

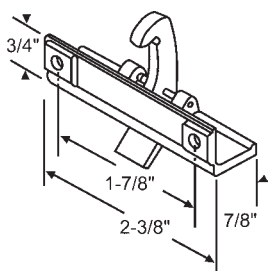

**50-735**  
White Bronze. Used with Keeper 50-736

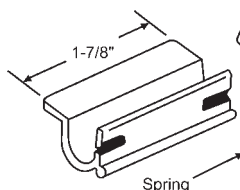

**50-633**  
Nylon

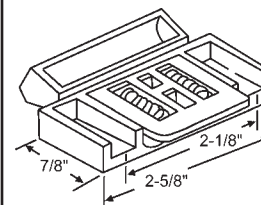

**50-660**  
Nylon

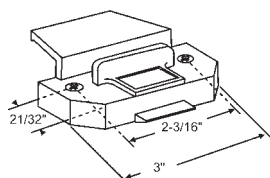

**900-6734B**  
Die cast with tabs on bottom.  
Black  
**CAPITOL**

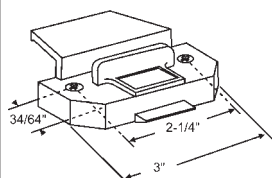

**50-1203**  
Die Cast  
Chrome Plated

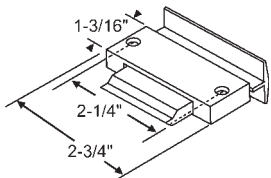

**900-11566A**  
Black Metal  
Used with Keeper 900-11567  
**TRACO TR6000 SERIES**

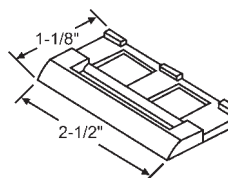

**900-11567**  
Latch Keeper for 900-11566A  
**TRACO TR6000 SERIES**

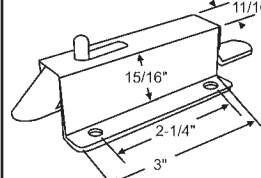

**50-919**  
Aluminum



# WINDOW REPLACEMENT HARDWARE

## SPRING TYPE SLIDER LATCHES

Spring type latches in order by mounting hole distance and length.

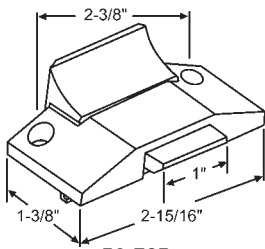

**50-725**  
Black Aluminum  
**CAPITOL**

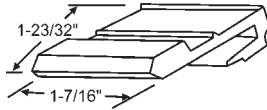

**900-7972**  
Black. Use with 50-725 Latch.  
**CAPITOL**

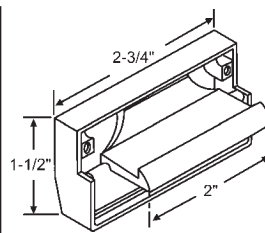

**900-11470**  
Plastic Handle with Metal  
Housing. Black

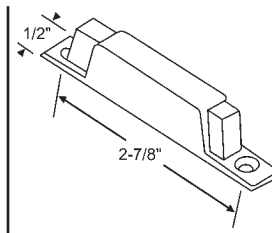

**50-615A**  
Nylon

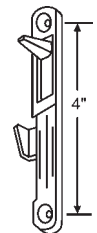

Part #	Hand
52-640	Shown
52-641	Opposite

Slider Lock

## EXTRUDED SASH HANDLES & LIFTS

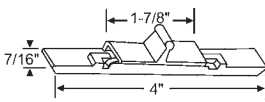

**900-9563**  
Black Plastic

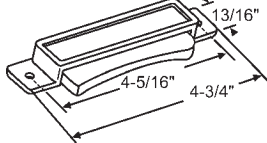

**50-848**  
Black Aluminum

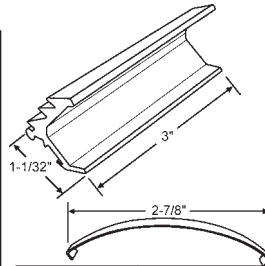

Part #	Finish
50-1405BZ	Bronze
50-1405W	White

Spring Sold Separately  
(900-17213)

**PGT**

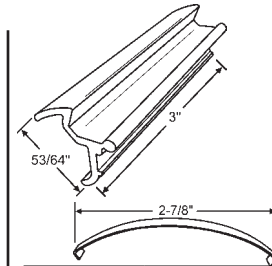

Part #	Finish
50-1406BZ	Bronze
50-1406W	White

Spring Sold Separately  
(900-17213)

**PGT**

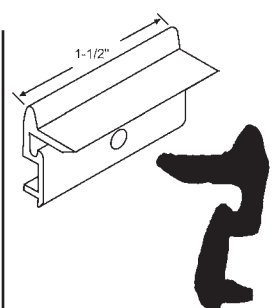

Part #	Finish
900-8615	Black

Glazing Clip, Nylon

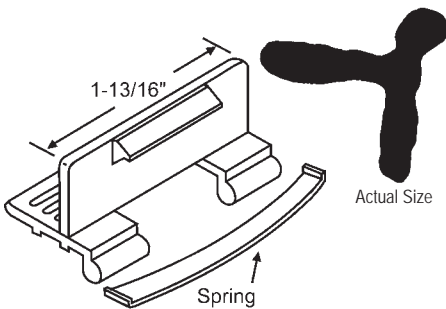

Part #	Finish
50-729	Black

Aluminum  
**NU-AIRE**

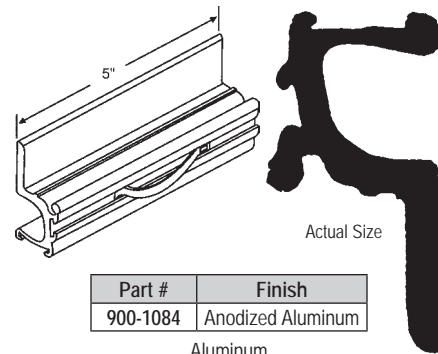

Part #	Finish
900-1084	Anodized Aluminum

Aluminum

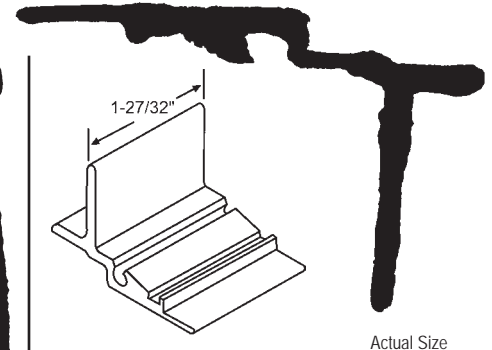

**900-10875**  
No Longer Available

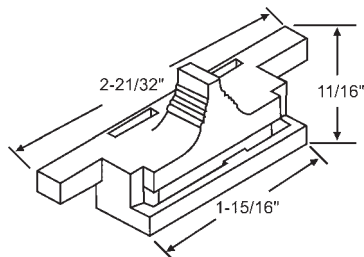

Part #	Finish
900-5484A	White

Plastic Slider Lock with Spring  
**CROSSLY**

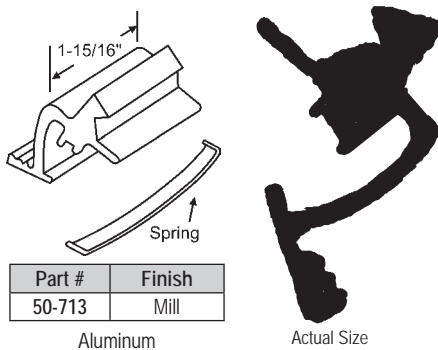

Part #	Finish
50-713	Mill

Aluminum

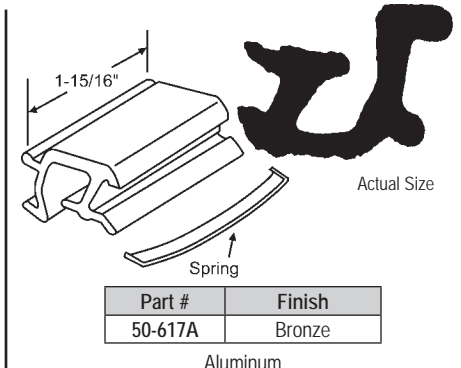

Part #	Finish
50-617A	Bronze

Aluminum

# WINDOW REPLACEMENT HARDWARE

## EXTRUDED SASH HANDLES & LIFTS

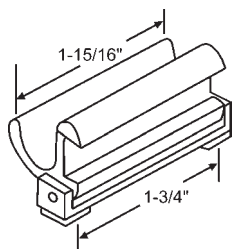

Part #	Finish
50-626	Mill

Aluminum  
**KELLER**

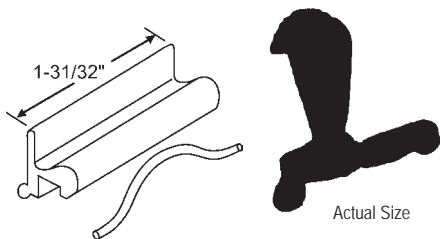

Part #	Finish
50-708	Black
50-708W	White

Plastic

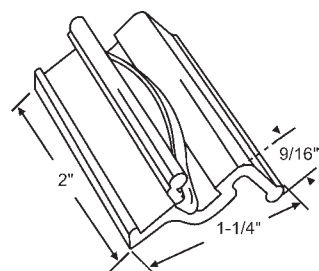

Part #	Finish
50-751A	Earth Brown
50-751WA	White

**CAPITOL**

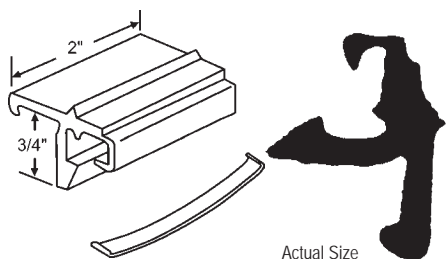

Part #	Finish
50-629A	Mill

Aluminum  
**CROSSLY**

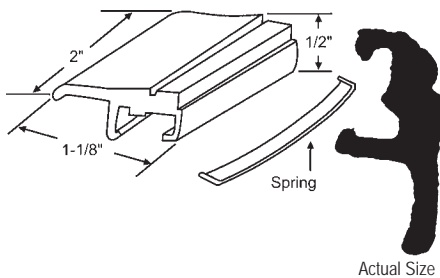

Part #	Finish
50-778W	White
50-778	Mill

Aluminum  
**ROLLYSON**

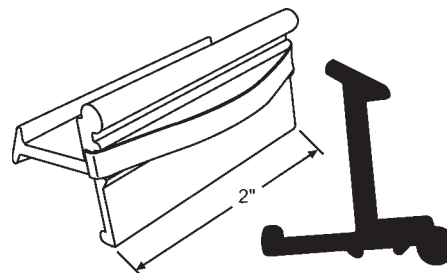

**50-1312**  
Mill. Includes Spring

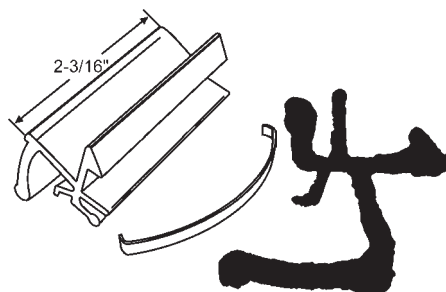

Part #	Finish	Description
900-9560BRA	Brown	with Spring

Aluminum. 900-10495S for Spring Only  
**ACORN**

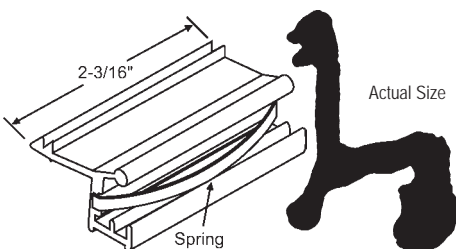

Part #	Finish
900-9559	White
900-9559A	Almond
900-9559B	Bronze
900-9559TN	Tan

Aluminum

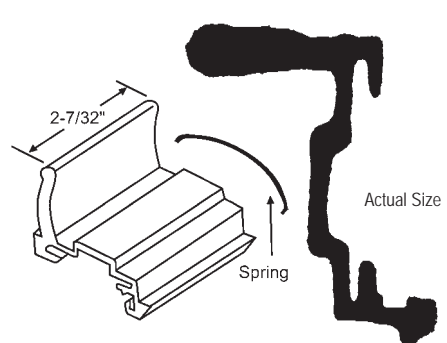

Part #	Finish
50-706	Mill

Aluminum

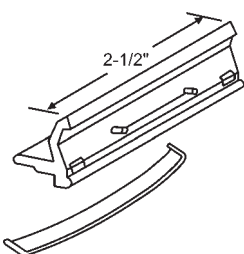

Part #	Finish
50-707	Black

Plastic

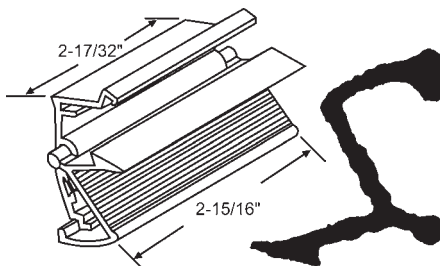

**900-11565**  
No Longer Available  
Use: 50-867A

Actual Size

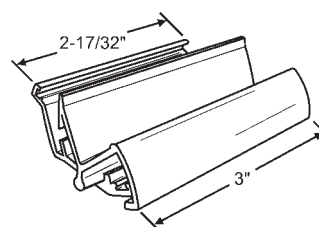

Part #	Finish
50-867A	Black

with Spring  
**TRACO**

# WINDOW REPLACEMENT HARDWARE

## EXTRUDED SASH HANDLES & LIFTS

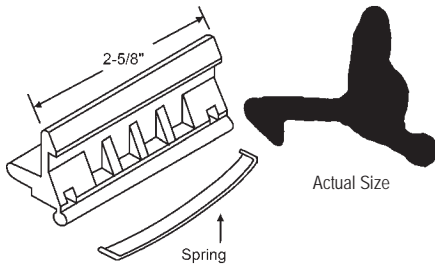

Actual Size

Part #	Finish
50-768WH	White
50-768	Black

Plastic

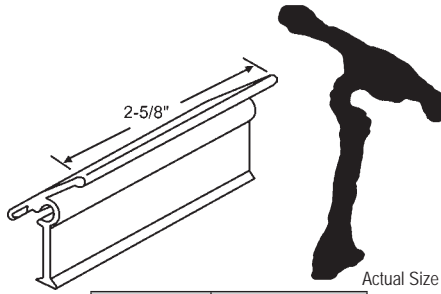

Actual Size

Part #	Finish
900-11342BZ	Bronze

Aluminum  
**HOWARD**

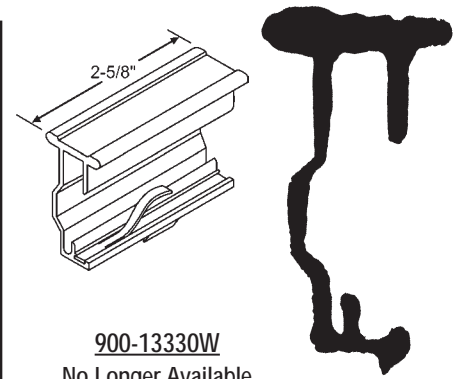

Actual Size

**900-13330W**  
No Longer Available

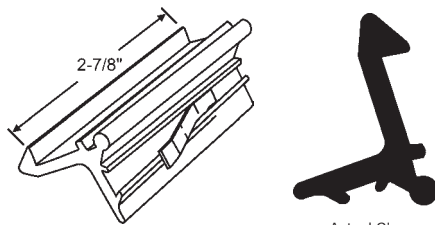

Actual Size

Part #	Finish
50-1313W	White

Includes Spring

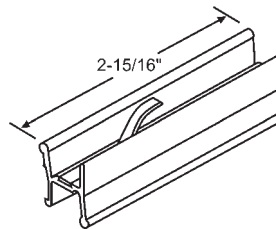

Part #	Finish
50-793W	White
50-793BR	Bronze

Aluminum

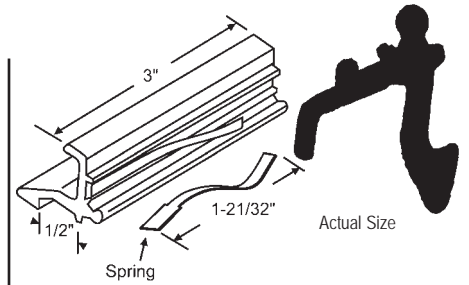

Actual Size

Part #	Finish
900-20772	Mill

Aluminum

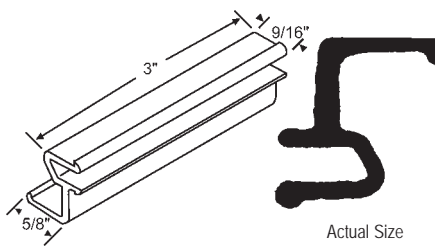

Actual Size

Part #	Finish
900-16656W	White
900-16656B	Black

Aluminum

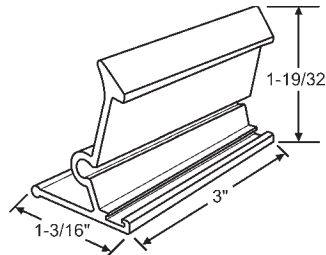

Part #	Finish
50-1324	Mill
50-1324BZ	Bronze
50-1324W	White

Aluminum  
**TRACO**

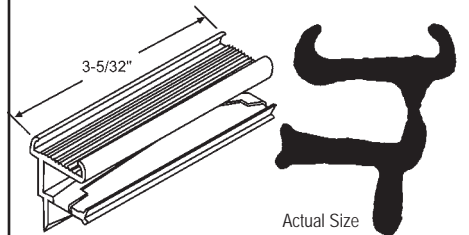

Actual Size

Part #	Finish
900-1088	Black

Plastic

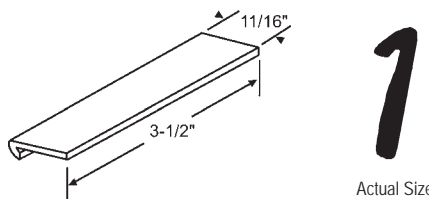

Actual Size

Part #	Finish
50-622	White

Aluminum  
Slider Latch Plate

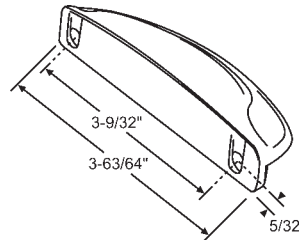

Part #	Finish
50-1311BP	Brass Plated
50-1311W	White

Zinc Die Cast. Matching Screws Included

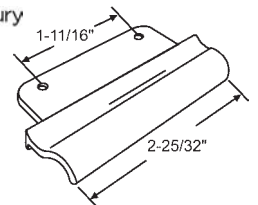

Part #	Finish
50-1310-1	Bronze
50-1310-5	Bright Brass
50-1310-13	Brushed Copper Nickel
50-1310-18	Sahara Beige
50-1310-36	Brushed Antique Brass
50-1310-40	Snow White
50-1310-80SP	Western Pewter

# WINDOW REPLACEMENT HARDWARE

## SASH LIFTS

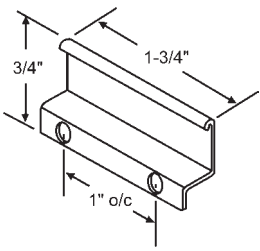

### 50-839

Meeting Rail Strike Plate. Used with 50-840 and 50-840BZ

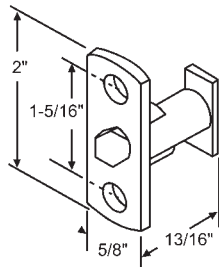

### 50-841

Auto Lock Plunger. Black Housing with Aluminum Plunger. Used with 50-839, 50-840 and 50-840BZ

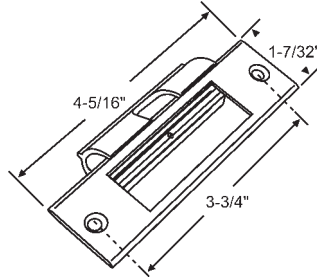

Part #	Finish
50-840	Clear Anodized
50-840BZ	Bronze Anodized

Auto Thumb Spring Lock. Metal  
**EFCO**

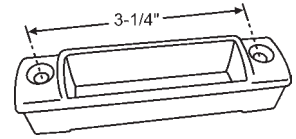

Part #	Finish
50-1121	Driftwood
50-1121W	White

Includes Screws  
**PEACHTREE**

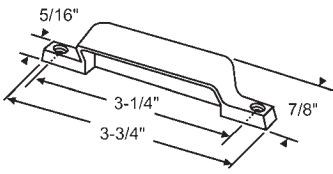

Part #	Finish
50-873W	White
50-873BZ	Bronze

Plastic

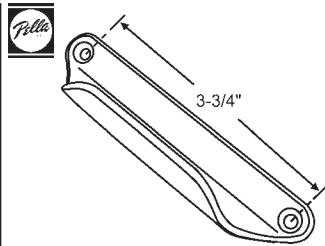

Part #	Finish
50-980CHP	Champagne
50-980W	White
50-980BRS	Brass Plated

Plastic

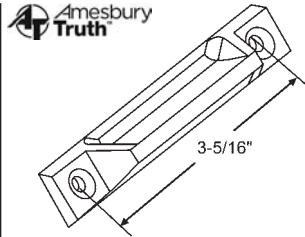

Part #	Finish
50-404-1	Bronze
50-404-3	White
50-404-2	Gold
50-404-4	Coppertone

Zinc Die Cast

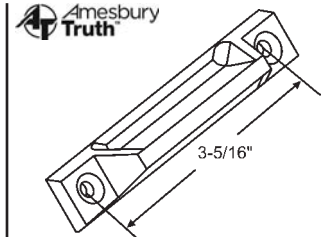

Part #	Finish
900-16321	White
900-16321BR	Brown
900-16321B	Black
900-16321BG	Beige

Plastic

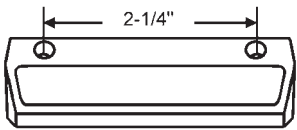

Part #	Finish
900-19442	Beige
900-19442B	Brown
900-19442T	Tan

Plastic

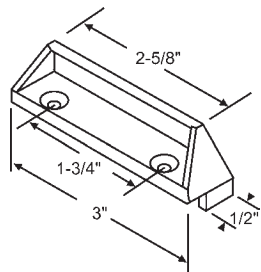

Part #	Finish
900-16287	White

Plastic  
**SEASONALL**

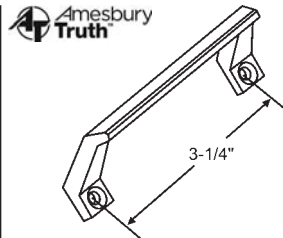

Part #	Finish
50-405-1	Bronze
50-405-3	White
50-405-5	Brass Plated
50-405-6	Clay

Die Cast

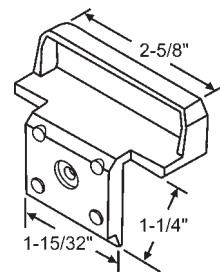

Part #	Finish
900-8729	White

Plastic  
**THERMALGARD**

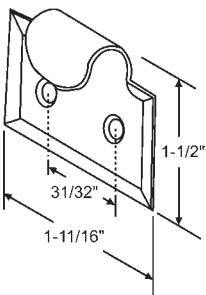

Part #	Finish
50-966	Solid Brass

Hook Lift w/ Screws (2 Per Pack)

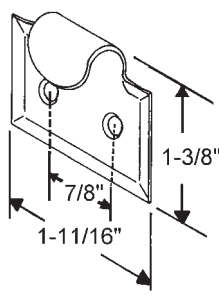

Part #	Finish
900-6687	Brass Plated

Includes Screws

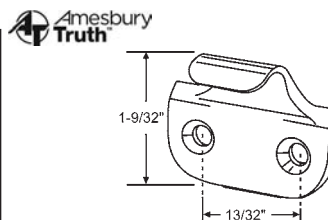

Part #	Finish
50-475-1	Bronze
50-475-3	White
50-475-13	Copper Nickel
50-475-36	Antique Brass
50-475-5	Bright Brass

Zinc Die Cast

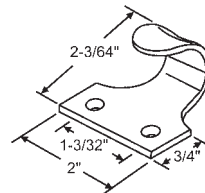

Part #	Finish
50-1101BRS	Solid Brass
50-1101CH	Chrome

Also available in satin chrome finish.

**MIGHTON**

# WINDOW REPLACEMENT HARDWARE

## SASH LIFTS

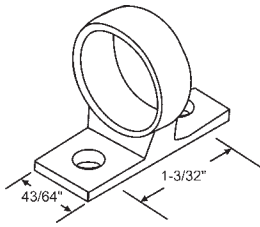

Part #	Finish
50-1102BRS	Solid Brass

Ring Pull. Also available in satin chrome finish.  
**MIGHTON**

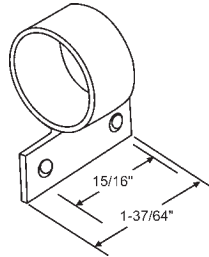

Part #	Finish
50-1103BRS	Solid Brass

Ring Pull. Also available in satin chrome finish.  
**MIGHTON**

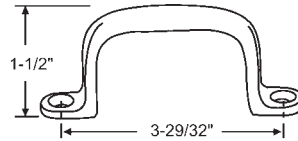

Part #	Finish
900-9194	Bronze

Cast Bronze

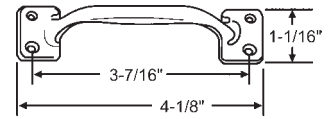

Part #	Finish
50-455-1	Bright Brass

Solid Brass with Screws

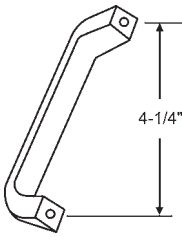

**32-281**  
Natural Finish  
**THORN**

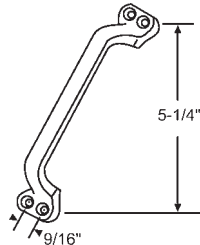

**32-282**  
Natural Finish

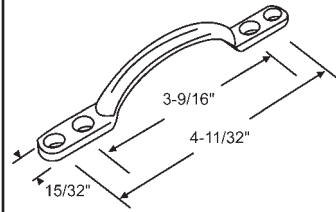

**50-1104CH**  
Round Edge Dee Handle  
Chrome  
**MIGHTON**

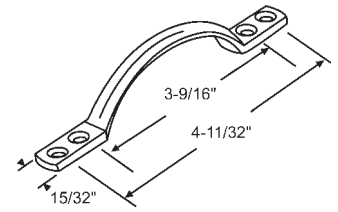

**50-1104BRS**  
Square Edge D Handle  
Solid Brass  
**MIGHTON**

## LIMIT LOCKS

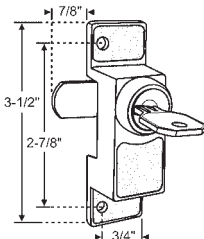

Part #	Finish	Hand
50-1374B	Black	Shown
50-1374W	White	Shown

Window/Door Limit Lock with Key. Zinc Die Cast

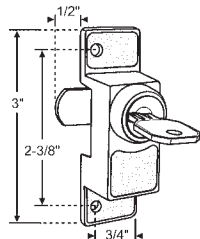

Part #	Finish	Hand
50-737RH	Chrome	Shown
50-737LH	Chrome	Opposite

Window/Door Limit Lock with Key  
Zinc Die Cast

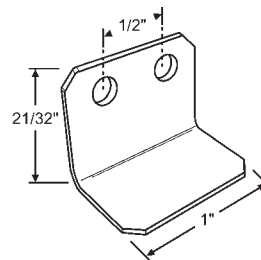

**50-837**  
Metal Keeper for Limit Locks

## TILT LATCH SWEEP LOCK

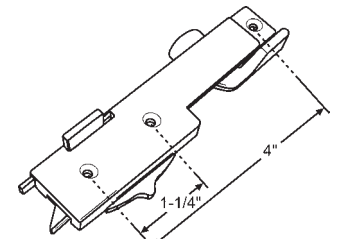

Part #	Finish	Hand
50-1258LHW	White	Shown
50-1258RHW	White	Opposite

Milestone/Florida Extruders

## VENT LOCKS

### Key Operated Vent Lock

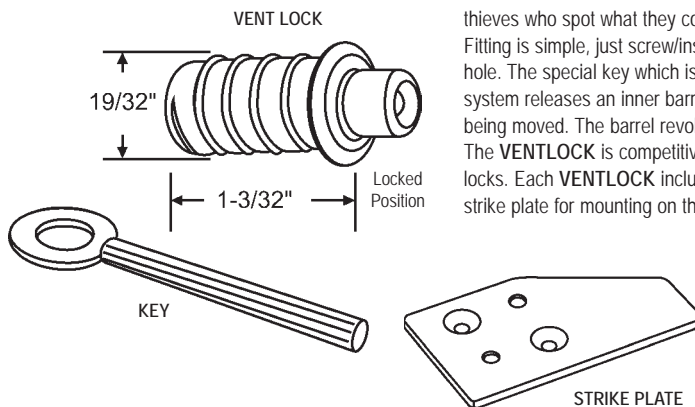

The new innovative **VENTLOCK** acts as a major deterrent to snatch thieves who spot what they consider is an easily opened window. Fitting is simple, just screw/insert it into the appropriate diameter drill hole. The special key which is supplied as part of the **VENTLOCK** system releases an inner barrel which prevents the window from being moved. The barrel revolves freely preventing it from being cut. The **VENTLOCK** is competitively priced against existing window locks. Each **VENTLOCK** includes a steel operation key and a brass strike plate for mounting on the lower sash check rail.

Part #	Finish
50-446	Solid Brass
50-446CH	Chrome

Vent Lock with Key and Strike  
**MIGHTON**

MEETS: ASTM F 2090 Standard Specification for Window Fall Prevention Devices With Emergency Escape (Egress) Release Mechanisms

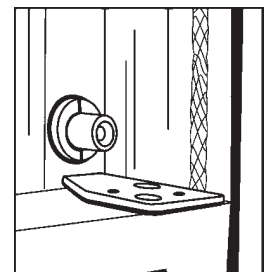

Open Position Shown

# WINDOW REPLACEMENT HARDWARE

## WINDOW OPENING CONTROL DEVICES (WOCD)



### Reverse Retrofit Single Action



The Reverse Retrofit Angel Ventlock is the ideal limit control device in aftermarket applications. This Window Opening Control Device (WOCD) can be mounted on a vinyl, wood or aluminum single hung or double hung window.

The Reverse Retrofit Angel Ventlock version attaches to the window frame and must be mounted to restrict the sash opening to less than four inches. These units are single action, so installing one on either side of the window frame ensures compliance with the code ASTM F2090-2008 and 2010.

Various sizes and finishes of the Reverse Retrofit version are shown below. Selection is dependent upon the distance from the face of the frame to the face of the sash. Simply measure the distance between the two and choose the part number from the chart below.

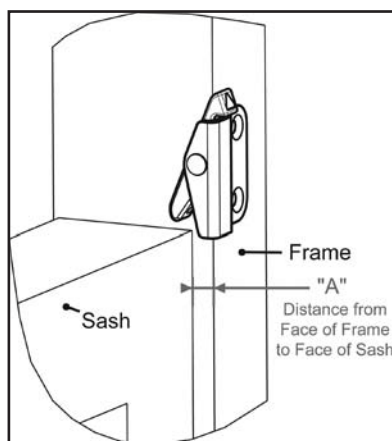

Part Number	Color	"A" Dimension
50-1356XDBCH	Chrome	-5/64" to 0"
50-1356XDBORBZ	Oil Rubbed Bronze	
50-1356XDBW	White	1/32" to 5/64"
50-1357DBCH	Chrome	
50-1357DBORBZ	Oil Rubbed Bronze	1/8" to 5/32"
50-1357DBW	White	
50-1358MBCH	Chrome	13/64" to 15/64"
50-1358MBORBZ	Oil Rubbed Bronze	
50-1358MBW	White	9/32" to 5/16"
50-1359MBCH	Chrome	
50-1359MBORBZ	Oil Rubbed Bronze	23/64" to 25/64"
50-1359MBW	White	
50-1360SBCH	Chrome	7/16" to 15/32"
50-1360SBORBZ	Oil Rubbed Bronze	
50-1360SBW	White	33/64" to 35/64"
50-1361XSCH	Chrome	
50-1361XSORBZ	Oil Rubbed Bronze	33/64" to 35/64"
50-1361XSCH	Chrome	
50-1361XSORBZ	Oil Rubbed Bronze	33/64" to 35/64"
50-1361XSCH	Chrome	
50-1361XSORBZ	Oil Rubbed Bronze	33/64" to 35/64"
50-1361XSCH	Chrome	
50-1362FBCH	Chrome	33/64" to 35/64"
50-1362FBORBZ	Oil Rubbed Bronze	
50-1362FBW	White	

Packed with Screws & Sold in Pairs (RH Shown).

Made of Stamped Steel with Stainless Steel Pin and Spring

### Standard Retrofit Single Action



The Standard Retrofit Angel Ventlock is another ideal limit control device for use in aftermarket applications. This Window Opening Control Device (WOCD) is mounted to the top sash on a double hung wood window.

The Standard Retrofit Angel Ventlock version fits into the stile of the top sash and must be mounted to restrict the bottom sash opening to less than four inches. These units are single action, so installing one on either side of the sash ensures compliance with the code ASTM F2090-2008 and 2010.

Various sizes and finishes of the Standard Retrofit version are shown below. Selection is determined by measuring the window gap between the top sash and the bottom sash. Simply measure the distance between the two and select the part number from the chart below.

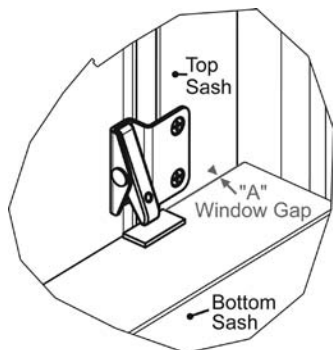

Part Number	Color	Bend	"A" Dimension
50-1363SBCH	Chrome	Standard	1/8" to 5/32"
50-1363SBORBZ	Oil Rubbed Bronze	Standard	
50-1363SBW	White	Standard	5/16" to 11/32"
50-1364SBCH	Chrome	Shallow	
50-1364SBW	White	Shallow	33/64" to 35/64"
50-1365FBCH	Chrome	Flat	
50-1365FBORBZ	Oil Rubbed Bronze	Flat	33/64" to 35/64"
50-1365FBW	White	Flat	

Packed with Screws & Sold in Pairs (RH Shown). Made of Stamped Steel, with Stainless Steel Pin and Spring

# WINDOW REPLACEMENT HARDWARE

## WINDOW OPENING CONTROL DEVICES (WOCD)

### Face Fix Single Action

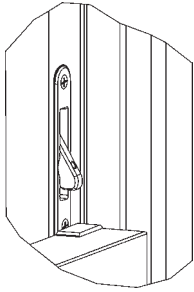

The Face Fix version is fitted into the stiles of the Top Sash - one on either side.

The units are single action, so fitting two ensures compliance with ASTM F2090 2008 and 2010.

The unit is primarily factory fitted as access to the sash is available prior to installation in the window frame. However, provided the sashes can be removed easily, the Face fix version is also suitable for use where the sashes have already been installed.

Two screws are used to fix each unit in place. Fixing is through the front of the unit and into the sash. The Face fix version is for use on Timber, Vinyl, Aluminium and Fibreglass sashes.

Part Number	Color
50-1367FFBRS	Brass
50-1367FFORBZ	Oil Rubbed Bronze
50-1367FFW	White
50-1367FFCH	Chrome
50-1367FFSCH	Satin Chrome

Packed and Sold as Kit. Kit Contains 2 Devices, 4 Screws and 2 Bumpers

### Side Fix Single Action

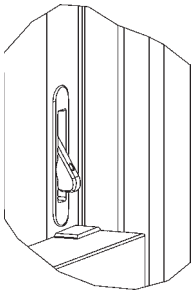

The Side Fix version is fitted into the stiles of the Top Sash - one on either side.

The units are single action, so fitting two ensures compliance with ASTM F2090 2008 and 2010.

These units have been Focus group tested and have been proven to be operable without prior knowledge or tools.

The unit is primarily factory fitted as access to the sash is available prior to installation in the window frame. However, provided the sashes can be removed easily, the Side fix version is also suitable for use where the sashes have already been installed.

Two screws are used to fix each unit in place. Fixing is through the side of the unit and into the sash. Screw holes are not visible and the units are therefore tamper-proof. The Side fix version is for use on Timber, Vinyl, Aluminium and Fibreglass sashes.

Part Number	Color
50-1366SFCH	Chrome
50-1366SFORBZ	Oil Rubbed Bronze
50-1366SFW	White

Packed and Sold in Pairs

### Reverse Retrofit Dual Action



The Dual Action Reverse Retrofit Angel Ventlock is another ideal limit control device for use in aftermarket applications. This Window Opening Control Device (WOCD) is primarily used on sliding windows.

The Dual Action Reverse Retrofit Angel Ventlock version attaches to the window frame and must be mounted to restrict the sash opening to less than four inches. Dual action means that two separate actions are required to operate the unit. Only one dual action unit is required to ensure compliance with the code ASTM F2090-2008 and 2010.

Various sizes and finishes of the Dual Action Reverse Retrofit version are shown below. Selection is dependent upon the distance from the face of the frame to the face of the sash. Simply measure the distance between the two and choose the part number from the chart below.

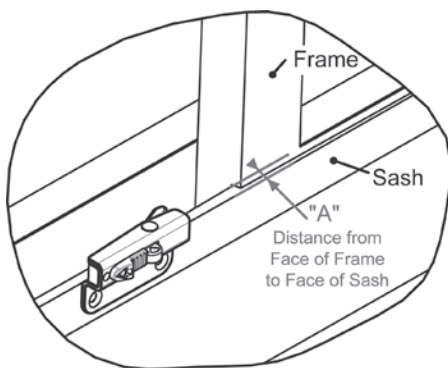

Part Number (Left Hand)	Part Number (Right Hand)	Color	Bend	"A" Dimension
50-1353-DBCH-LH*	50-1353-DBCH-RH	CHROME	DEEP	1/32" to 7/64"
50-1353-DBORBZ-LH*	50-1353-DBORBZ-RH	OIL RUBBED BRONZE		
-	50-1353-DBW-RH	WHITE		
50-1353-MBCH-LH	50-1353-MBCH-RH	CHROME	MEDIUM	1/8" to 3/16"
50-1353-MBORBZ-LH	50-1353-MBORBZ-RH	OIL RUBBED BRONZE		
50-1353-MBW-LH	50-1353-MBW-RH	WHITE		
50-1353-M56CH-LH	50-1353-M56CH-RH	CHROME	M56	13/64" to 17/64"
50-1353-M56ORBZ-LH	50-1353-M56ORBZ-RH	OIL RUBBED BRONZE		
50-1353-M56W-LH	50-1353-M56W-RH	WHITE		
50-1353-SBCH-LH*	50-1353-SBCH-RH	CHROME	SHALLOW	9/32" to 11/32"
50-1353-SBORBZ-LH*	50-1353-SBORBZ-RH	OIL RUBBED BRONZE		
-	50-1353-SBW-RH	WHITE		
50-1353-XSBCH-LH	50-1353-XSBCH-RH	CHROME	XSB	23/64" to 27/64"
50-1353-XSBORBZ-LH	50-1353-XSBORBZ-RH	OIL RUBBED BRONZE		
50-1353-XSBW-LH	50-1353-XSBW-RH	WHITE		
50-1353-FBCH-LH	50-1353-FBCH-RH	CHROME	FLAT	7/16" to 33/64"
50-1353-FBORBZ-LH	50-1353-FBORBZ-RH	OIL RUBBED BRONZE		
50-1353-FBW-LH	50-1353-FBW-RH	WHITE		

\*call for availability

Packed with Screws & Sold Individually Specify RH or LH (RH Shown)  
Made of Stamped Steel with Stainless Steel Pin and Spring

# WINDOW REPLACEMENT HARDWARE

## WINDOW OPENING CONTROL DEVICES (WOCD)

### Mini Angel

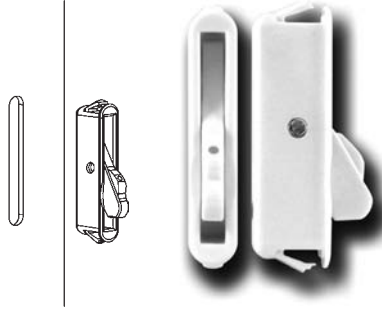

The Mini Angel is for use on Vinyl, Aluminum and Fiberglass double and single hung sash windows.

The units are single action, so fitting two ensures compliance with ASTM F2090 - 2008 and 2010.

The Mini Angel is fitted into the stiles of the top sash – one on each side. The units are single action, so fitting two ensures compliance with ASTM F2090 - 2008 and 2010.

The unit is primarily factory-fitted as access to the sash is required. However, provided the sashes can be removed easily, the Mini Angel is also suitable for use where the sashes have already been installed.

The unit is clipped into a slot in the face of the top sash. The units are therefore tamper-proof.

Part Number	Color
50-1453TN	Tan
50-1453W	White

Packed and Sold Individually

### SafeGuard™ Limiting Control Device for Casement Windows

#### SafeGuard™ Provides Peace Of Mind On Casement Window Applications.



#### Ordering Instructions:

- Determine window handing by viewing from the outside looking in. If the casement window hinge is on the right side, you need a right hand limiting device.
- Confirm the hinge cavity on your casement window (See Fig. 2). The hinge cavity needs to be .719 (23/32") wide x .438 (7/16") deep.

Note: The SafeGuard™ Limiting Control Device will only work in casement windows that have a standard 2-bar hinge cavity with measurements as stated above.

*This Device is Not Designed for Awning Windows.*

*This Device is Not Designed for Casement Windows with a 4-Bar Hinge.*

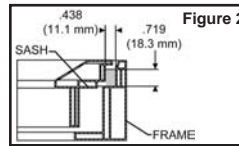

- The SafeGuard™ is the industry's first limiting control device offered for casement windows.
- The SafeGuard™ Limit Device was tested & certified to meet ASTM F2090-10 code requirements. The ASTM F2090 addresses window fall prevention, that helps protect against potential falls by children through open windows.
- The SafeGuard™ Limit Device provides a means that will limit the venting of the window to less than 4".
- As required by code, the SafeGuard™ Limit Device has a two (2) action operation to fully open the window for egress purposes. This operation can be performed without the use of keys or tools.
- Easy to follow opening and release instructions appear on the vent arm. Note: The device will re-latch or reset automatically when window is in closed position.
- The SafeGuard™ Limit Device's track, arm and rivet are made entirely of authentic stainless steel with Delran cover and tab.
- The SafeGuard™ Limit Device is reliable, easy to install and easy to operate. This device meets today's more stringent safety requirements. Please consult local building codes for WOCD and applicable requirements.



Part Number	Handing
39-933LH	LH
39-933RH	RH

Includes: Arm Assembly, Track Assembly, Template, Window Label, Screw Pack (4 screws) and Operating and Installation Instructions.

## VENT LOCKS

### Push and Twist Keyless Vent Lock Finger Operated: Push and Turn with Your Finger

MEETS: ASTM F 2090 Standard Specification for Window Fall Prevention Devices With Emergency Escape (Egress) Release Mechanisms

The natural companion product to Key Operated Ventlocks. Use where Fire Egress may be of concern or above ground floor level.

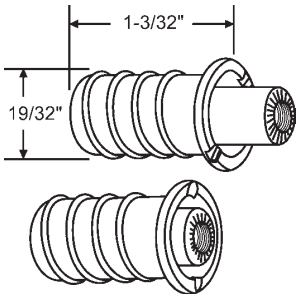

Part #	Finish
50-1201CH	Chrome
50-1201BRS	Solid Brass

Push and Twist Ventlock. Solid Brass  
**MIGHTON**

### Brass Vent Lock for PVC Vinyl Windows

Ventlock is Quick and Easy to Install

- Drill Hole
- Insert Ventlock
- Drill Rivet Holes
- POP Rivet Ventlock into the Sash
- Conceal Rivets with Self Adhesive Trims

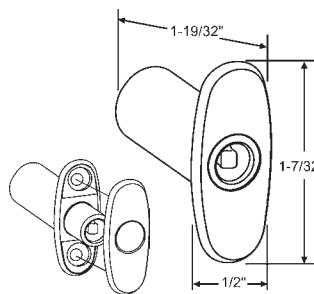

**50-1106**

Vent Lock for PVC Vinyl Windows  
Includes Key  
**MIGHTON**

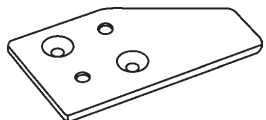
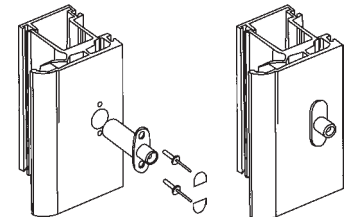

Part #	Finish
50-1105BRS	Solid Brass
50-1105CH	Chrome
50-1105SCH	Satin Chrome

Vent Lock Strike Plate Only  
**MIGHTON**



**59-73M**  
Ventlock Hand Tool  
**MIGHTON**

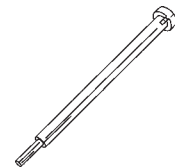

**59-73**  
Ventlock Tool for Cordless Drill  
**MIGHTON**



# WINDOW REPLACEMENT HARDWARE

## SASH RESTRICTER ASSEMBLY KIT

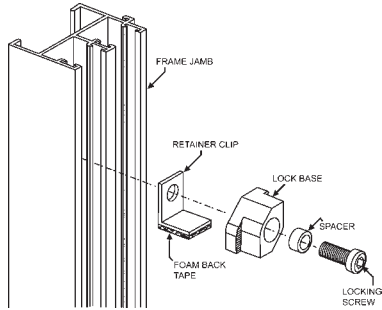

**50-1250**  
For Double Hung Window.  
Uses: 59-61 Allen Wrench  
**DEVAC**

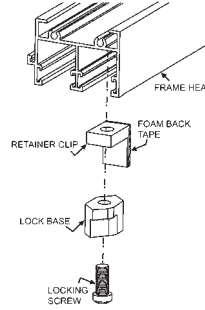

**50-1253**  
For Sliding Window. Uses:  
59-61 Allen Wrench  
**DEVAC**

## SLIDING WINDOW ROLLERS WITH METAL HOUSING

Sliding window rollers in order by roller diameter, length and width.

**5/16"**

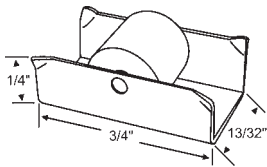

**52-615**  
5/16" Dia. Nylon Wheel

**11/32"**

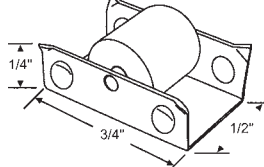

**900-1278**  
11/32" Dia. x 3/8" Nylon Wheel

**3/8"**

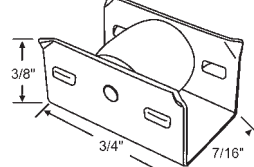

**52-616**  
3/8" Dia. Nylon Wheel

**29/64"**

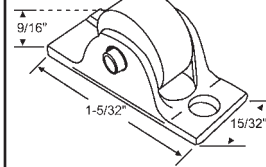

**900-10027**  
29/64" Dia. Nylon Wheel with Die Cast Housing

**15/32"**

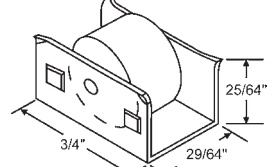

**900-1285**  
15/32" Dia. Flat Nylon Wheel

**1/2"**

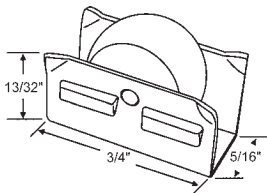

**52-614**  
1/2" Dia. Nylon Wheel

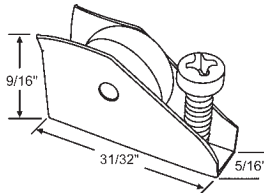

**52-683**  
1/2" Dia. Nylon Wheel  
**CAPITOL**

**9/16"**

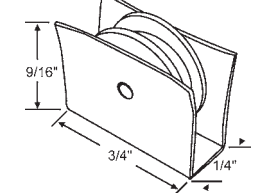

Part #	Description
52-613	Nylon Wheel
52-675	Metal Wheel

9/16" Wheel

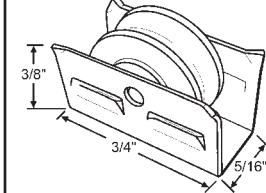

Part #	Description
900-13091	Nylon Wheel
900-13091S	Steel Wheel

9/16" Wheel

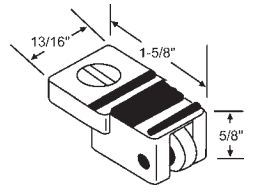

**52-682**  
9/16" Dia. Metal Wheel with Die Cast Housing. Used with Plate 900-16252

## SLIDING WINDOW ROLLERS WITH PLASTIC HOUSING

**5/8"**

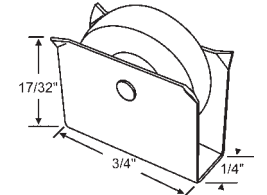

**900-1290**  
5/8" Dia. Flat Nylon Wheel

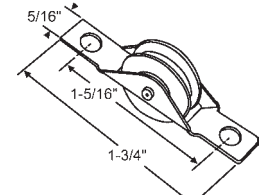

**52-650**  
5/8" Dia. Nylon Wheel

**9/32"**

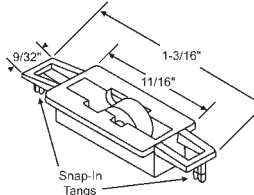

**52-766**  
9/32" Dia. Metal Wheel

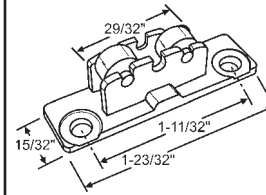

**900-10193**  
Two 9/32" Dia. Aluminum Wheels  
Nylon Housing  
**GENERAL ALUMINUM**

**5/16"**

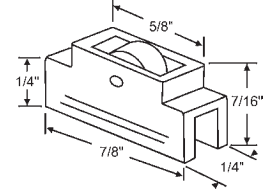

**52-643**  
5/16" Dia. Metal Roller

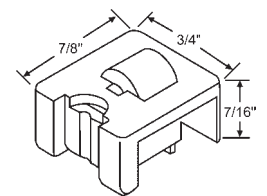

**900-11416**  
5/16" Dia. Metal Wheel  
w/Fixed Axle

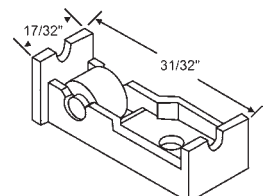

**900-14615**  
5/16" Dia. Flat Nylon Wheel w/  
Fixed Axle  
**KRESTMARK**

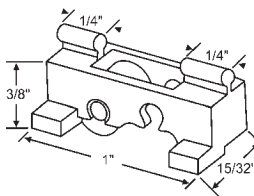

**900-22**  
5/16" Dia. Flat Metal Wheel  
w/Fixed Axle

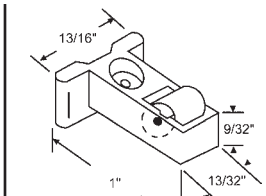

**52-638**  
5/16" Dia. Metal Wheel

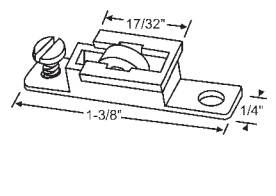

**52-856**  
5/16" Dia. Flat Nylon Wheel  
White  
**ACORN**

# WINDOW REPLACEMENT HARDWARE

## SLIDING WINDOW ROLLERS WITH PLASTIC HOUSING

Sliding window rollers in order by roller diameter, length and width.

**3/8"**

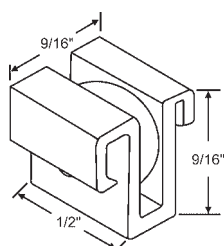

**52-646**

3/8" Dia. Nylon Wheel

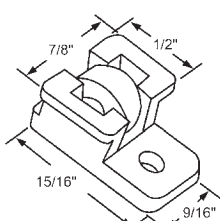

**900-18013**

3/8" Dia. Flat Metal Wheel  
w/Fixed Axle

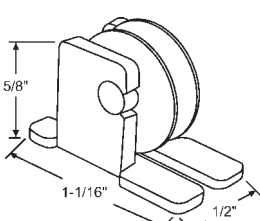

**52-644**

3/8" Dia. Metal Wheel  
**FULLVIEW**

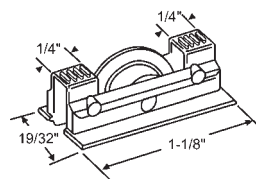

**900-10784**

3/8" Dia. Nylon Wheel with 1/2"  
Dia. Single Side Flange

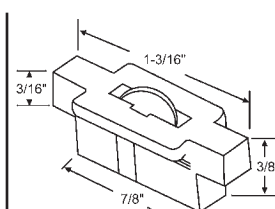

**52-648**

3/8" Dia. Metal Wheel

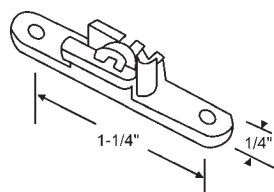

**52-649**

3/8" Dia. Metal Wheel

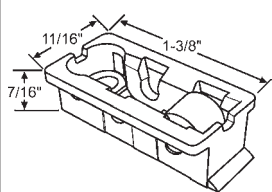

**52-913**

3/8" Dia. Brass Wheel  
Black Nylon

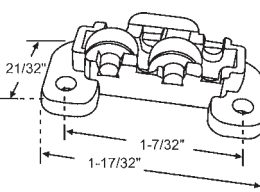

**52-789**

Two 3/8" Dia. Brass Wheels  
Black

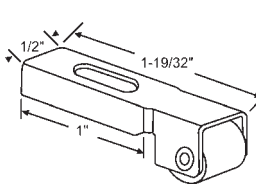

**900-1064**

3/8" Dia. Flat Nylon Wheel

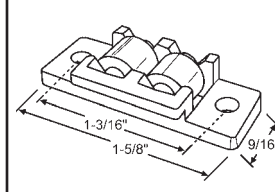

**52-737**

Two 3/8" Dia. Flat Steel Wheel

**25/64"**

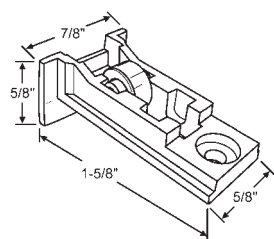

**900-10606**

White Nylon Housing with 3/8"  
Brass Wheel

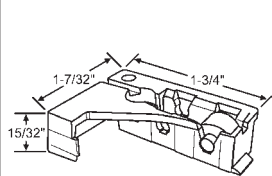

Part #	Hand
52-914LH	Shown
52-914RH	Opposite

3/8" Dia. Brass Wheel  
Black Nylon

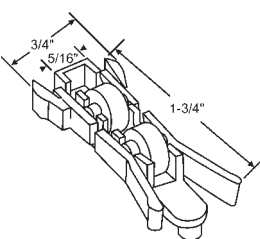

**52-724**

Two 3/8" Dia. Flat Brass Wheels  
w/Separate Axles  
**REYNOLDS**

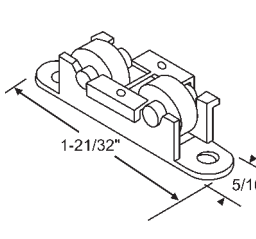

**900-10419**

Two 3/8" Dia. Nylon Wheels

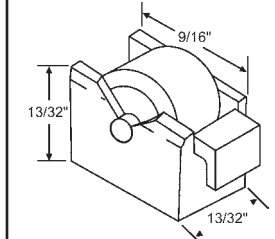

**52-647**

25/64" Dia. Metal Wheel

**13/32"**

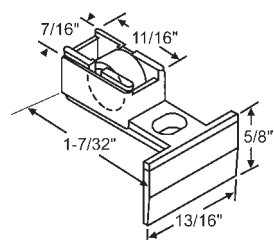

Part #	Description
900-9008	Nylon Wheel
900-9008M	Steel Wheel

13/32" Dia. Flat Wheel w/Fixed Axle  
**PENNCO**

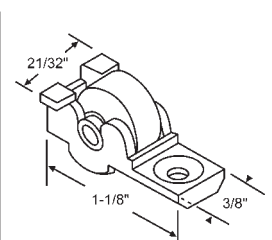

**900-9814**

13/32" Dia. Nylon Wheel

**PENNCO**

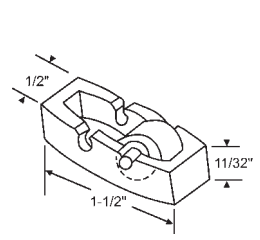

**52-629**

13/32" Dia. Metal Wheel

**CAPITOL**

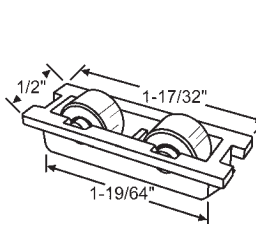

**52-540**

White Nylon Body w/ (2) 13/32"  
Brass Wheels  
**REHAU**

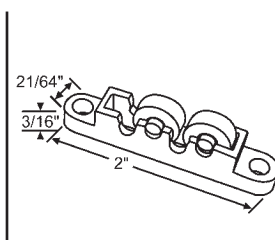

**52-722**

Two 13/32" Dia. Flat Brass  
Wheels w/Separate Axles. White

# WINDOW REPLACEMENT HARDWARE

## SLIDING WINDOW ROLLERS WITH PLASTIC HOUSING

Sliding window rollers in order by roller diameter, length and width.

### 7/16"

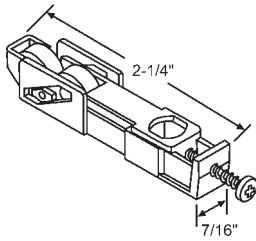

#### 900-19102

Two 13/32" Dia. Wheels  
Black  
**RUSCO**

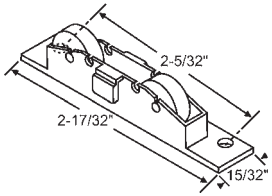

#### 52-799

Two 13/32" Dia. Aluminum  
Wheels w/Fixed Axles

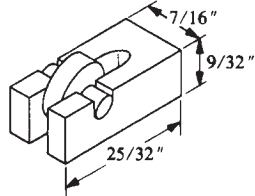

#### 900-12009

7/16" Dia. Nylon Wheel

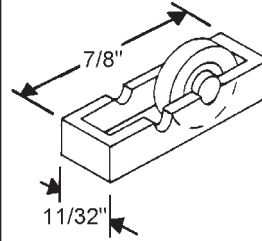

#### 900-9860

7/16" Dia. Flat Metal Roller with  
Separate Axle

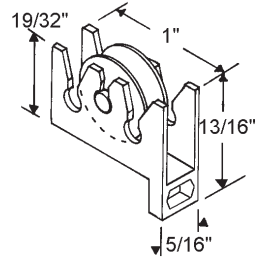

#### 900-11290

7/16" Dia. Metal Wheel  
w/Fixed Axle  
**ALENCO**

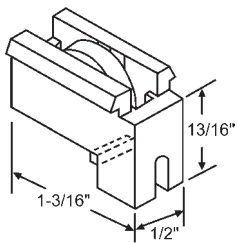

#### 900-11944NS

7/16" Dia. Brass Wheel  
Projects 1/8" from Housing

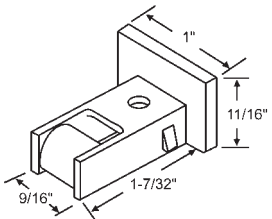

Part #	Description
52-686	Nylon Wheel
52-686M	Steel Wheel

7/16" Dia. Wheel  
**MEDALLION**

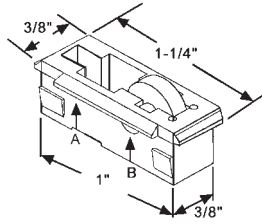

#### 52-733

7/16" Dia. Flat Metal Wheel  
w/Separate Axles. Roller Projects 1/8"  
in Position "A" and 1/16" in Position "B".

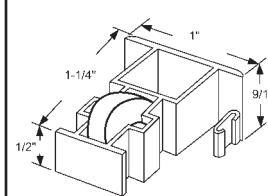

#### 52-843

7/16" Dia. Metal Wheel  
**NU-AIR**

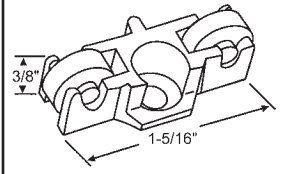

#### 52-658

Two 7/16" Dia. Nylon Wheels

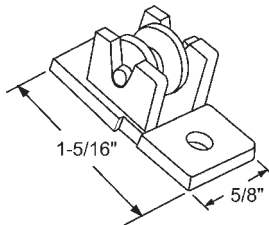

#### 900-19965

7/16" Dia. x 5/16" Wide Concave  
Wheel w/Fixed Axle. White

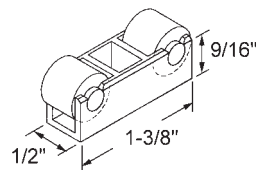

#### 52-514

Two 7/16" Dia. Nylon Wheels

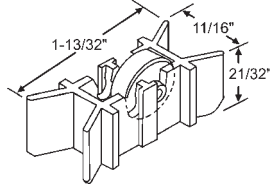

#### 900-12993A

7/16" Dia. Flat Metal Wheel

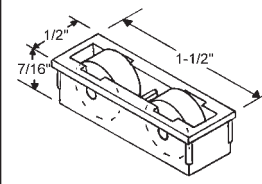

#### 900-17801

Two 7/16" Dia. Metal Wheels

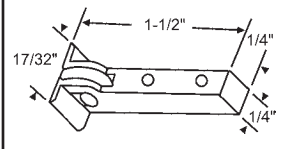

#### 900-92

7/16" Dia. Flat Nylon Wheel  
**GUARANTEED**

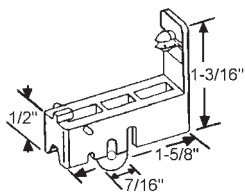

#### 900-1067

7/16" Dia. Nylon Wheel

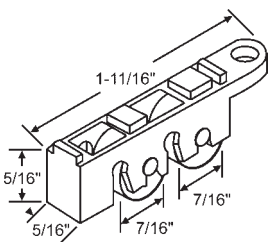

#### 900-19941

Two 7/16" Dia. Brass Wheels  
w/Separate Axles

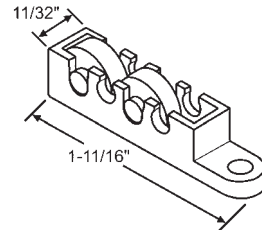

Part #	Description
900-15615	Brass Wheel
900-15615SS	Stainless Steel Wheel

Two 7/16" Dia. Wheels

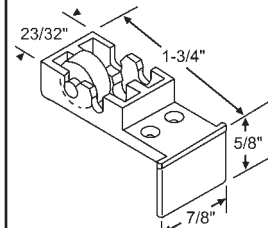

#### 52-690

7/16" Dia. Flat Wheel  
w/Fixed Axle  
**CAPITOL**

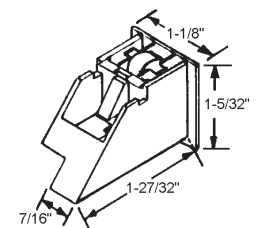

#### 52-715A

RH/LH Set, Black  
Two 7/16" Dia. Metal Wheels

# WINDOW REPLACEMENT HARDWARE

## SLIDING WINDOW ROLLERS WITH PLASTIC HOUSING

Sliding window rollers in order by roller diameter, length and width.

**15/32"**

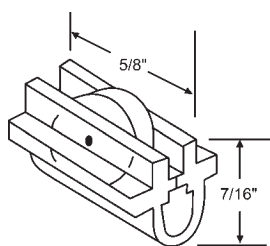

**52-661**

15/32" Dia. Nylon Wheel

**IDA**

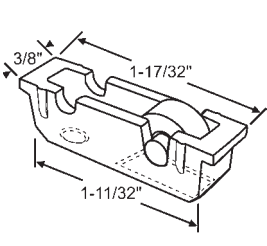

**52-823**

15/32" Metal Roller w/ Stainless Steel Axle. Nylon Body

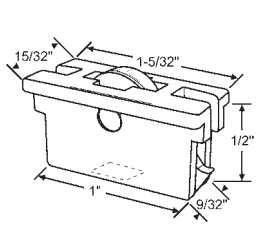

**52-417**

15/32" Dia. Brass Wheel White Nylon Housing

**ATRIUM**

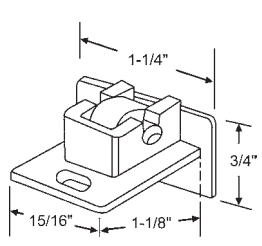

**900-17797**

15/32" Dia. x 1/4" Wide Flat Metal Wheel w/Fixed Axle Black

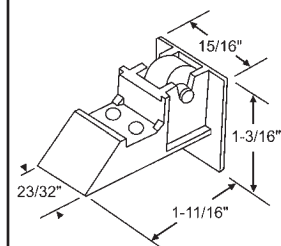

**900-19580BA**

15/32" Dia. Flat Metal Wheel w/Fixed Axle. Black

**NORANDEX**

**31/64"**

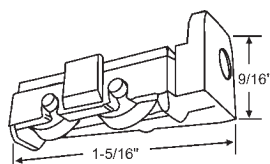

Part #	Hand
900-9391LHA	Shown
900-9391RHA	Opposite

Two 15/32" Dia. Brass Wheel

**ACORN**

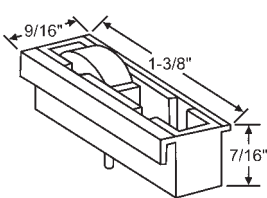

**52-938**

15/32" Dia. Metal Wheel

**PGT**

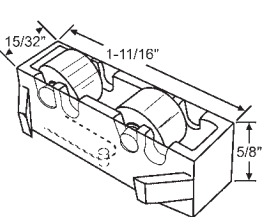

**52-533**

15/32" Dia. Brass Wheel

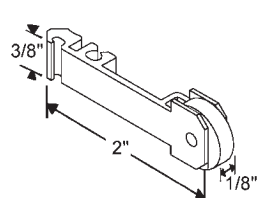

Part #	Description
52-778	Brass Plated Wheel

15/32" Dia. Wheel

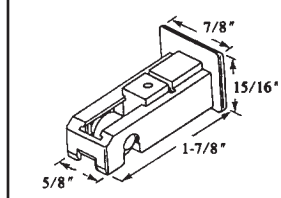

**52-695**

31/64" Dia. Nylon Wheel

**1/2"**

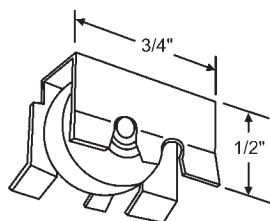

**900-14936**

1/2" Dia. Metal Wheel

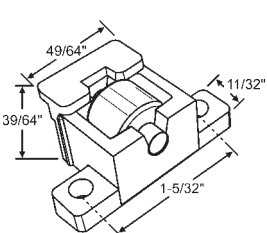

**52-781MA**

1/2" Brass Roller

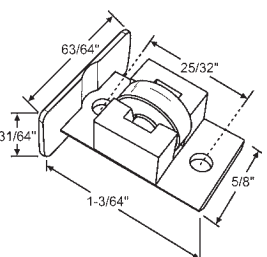

**52-882**

Nylon Housing w/ 1/2" Dia. Brass Wheel

**MILESTONE/ FLORIDA EXTRUDERS**

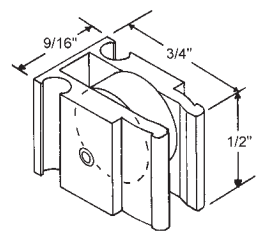

**900-12179**

1/2" Dia. Flat Steel Wheel

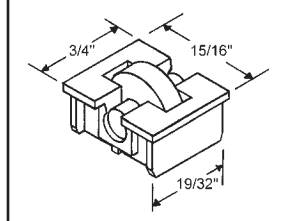

**52-718**

1/2" Dia. Flat Wheel w/Fixed Axle

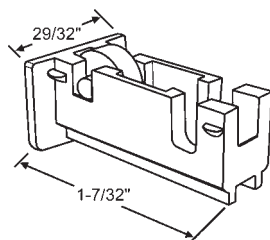

**900-10420**

1/2" Dia. Brass Wheel

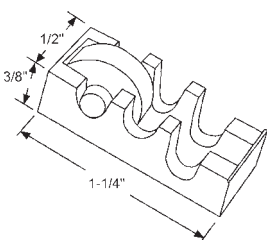

**900-8995**

1/2" Dia. Flat Metal Wheel w/ Separate Axle

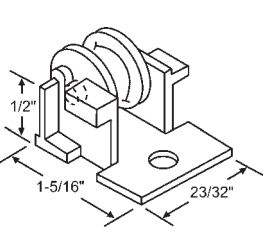

**900-10454**

1/2" Dia. Metal Wheel w/Separate Axle

**KRESTMARK**

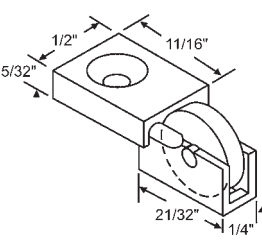

**900-8212**

1/2" Dia. Flat Nylon Wheel w/Fixed Axle

**KELLER/ACORN**

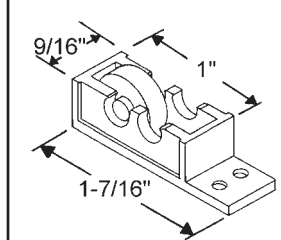

**52-712**

1/2" Dia. Flat Metal Wheel w/Fixed Axle

# WINDOW REPLACEMENT HARDWARE

## SLIDING WINDOW ROLLERS WITH PLASTIC HOUSING

Sliding window rollers in order by roller diameter, length and width.

**1/2"**

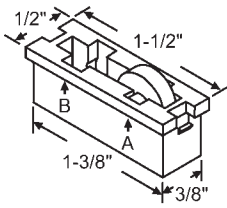

**52-859**

Black Housing with 1/2" Dia. Flat Brass Wheel. Roller Projects 3/32" in Position "A" and 5/32" in Position "B".

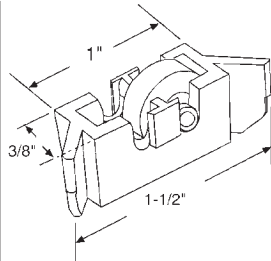

**900-12857**

1/2" Dia. Brass Wheel w/Separate Axle

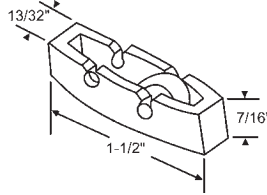

**Part #**

**Description**

**52-632** Stainless Steel Wheel

**52-632A** Aluminum Wheel

1/2" Dia. Wheel and Axle

**CAPITOL**

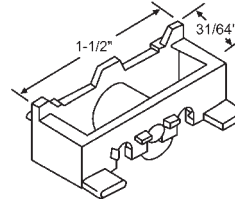

**52-684**

1/2" Dia. Nylon Wheel

**CHAMBERLAIN**

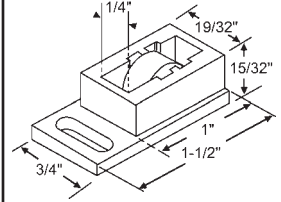

**Part #**

**Description**

**900-1293** Flat Metal Wheel

**900-1293A** Flat Brass Wheel

1/2" Dia. Wheel

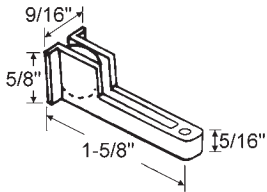

**52-790**

1/2" Dia. Flat Nylon Wheel

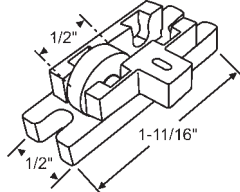

**900-20288**

1/2" Dia. Roller. Black Roller Only: 900-20288R

**ROLLYSON 500 SERIES**

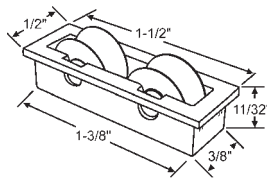

**Part #**

**Description**

**52-546** Brass Wheel

**52-546N** Nylon Wheel

**52-546SS** Stainless Steel Wheel

Two 1/2" Dia. Wheels

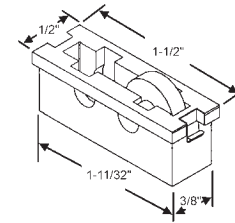

**52-826**

1/2" Dia. Fixed Axle Metal Rollers Rollers Project 3/32" from Edge of Housing. White Housing with 1 Roller

**SILVERLINE**

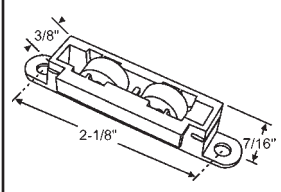

**52-937**

Two 1/2" Dia. Brass Wheels Nylon Body

**33/64"**

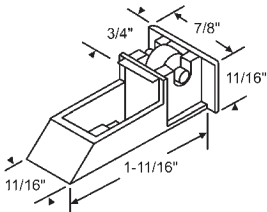

**900-16704**

1/2" Dia. Flat Metal Wheel Black

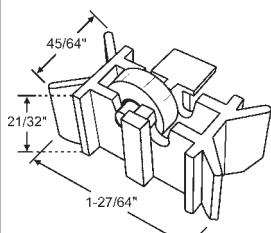

**900-20955**

White Nylon Housing with 1/2" Dia. Steel Wheel

**ALENCO**

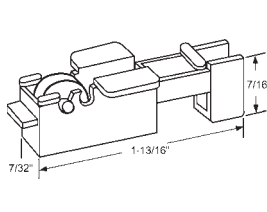

**52-807**

1/2" Dia. Wheel

**ACORN**

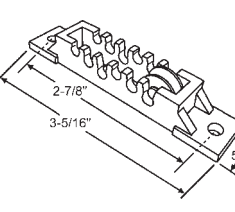

**52-534**

1/2" Dia. Nylon Wheel

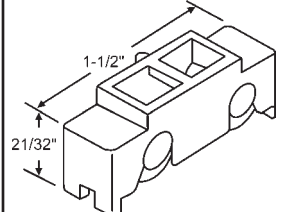

**52-689**

Two 33/64" Dia. Nylon Wheels

**GALLATIN**

**17/32"**

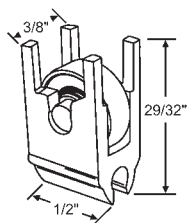

**52-732**

17/32" Dia. Steel Wheel Nylon Body

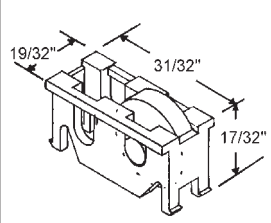

**900-8996**

17/32" Dia. Metal Wheel

**SULLIVAN**

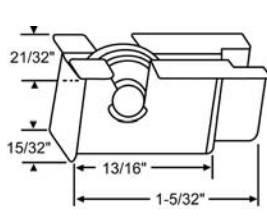

**52-707**

17/32" Dia. Metal Wheel

**REYNOLDS**

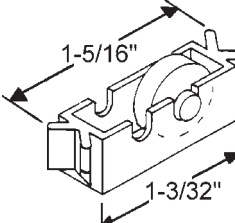

**900-10293**

17/32" Dia. Flat Metal Wheel w/Separate Axle

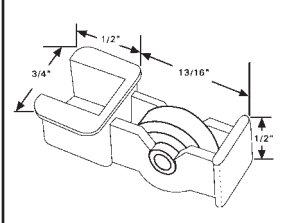

**900-9765**

17/32" Dia. Flat Ball Bearing Wheel w/Fixed Axle

# WINDOW REPLACEMENT HARDWARE

## SLIDING WINDOW ROLLERS WITH PLASTIC HOUSING

Sliding window rollers in order by roller diameter, length and width.

**17/32"**

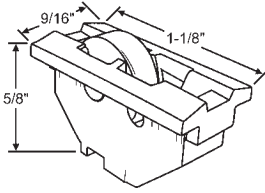

**52-301**  
17/32" Dia. Brass Wheel  
Nylon Housing  
**SEASONSIELD**

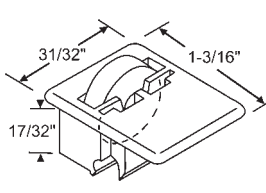

**900-10192**  
17/32" Dia. Flat Metal Wheel  
w/Separate Axle

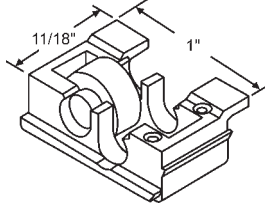

**52-713**  
17/32" Dia. Flat Wheel  
**CAPITOL**

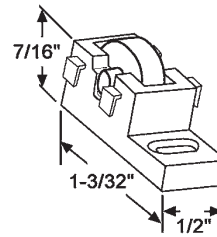

**900-20289**  
17/32" Dia. Flat Metal Wheel w/  
Separate Axle  
**ROLLYSON**

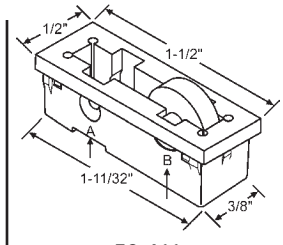

**52-411**  
17/32" Dia. Metal Wheel with  
Separate Axle. Roller Projects  
1/32" in Position "A" and 1/8" in  
Position "B".  
**ACORN**

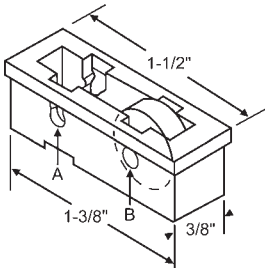

**900-12609**  
17/32" Dia. Wheel  
Roller Projects 1/16" in Position  
"A" and 3/32" in Position "B".

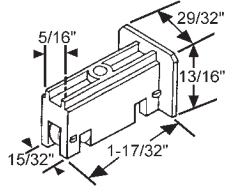

**900-20286**  
17/32" Dia. Flat Ball Bearing  
Wheel w/Fixed Axle

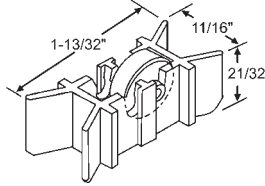

**900-12993**  
17/32" Dia. Wheel

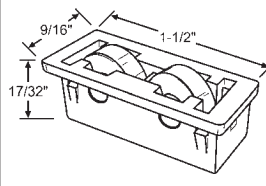

**52-934**  
Two 17/32" Dia. Brass Wheels

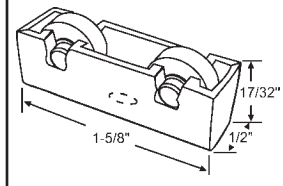

**900-11791**  
Two 17/32" Dia. Metal Wheel  
**KELLER**

**9/16"**

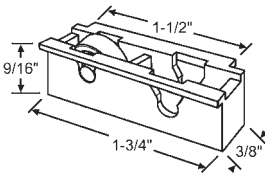

**900-11564**  
17/32" Dia. Steel Ball  
Bearing Wheel

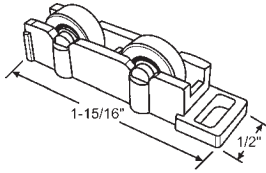

Part #	Description
52-731	Brass Wheel
52-731SS	Stainless Steel Wheel

Two 17/32" Dia. Wheels

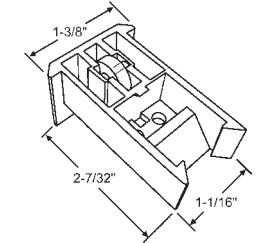

Part #	Description
900-22185	Black Housing
900-22185W	White Housing

17/32" Dia. Brass Wheel  
and Axle.

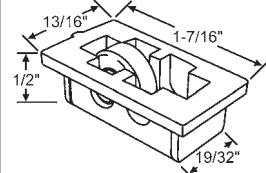

**52-676**  
17/32" Dia. Metal Wheel  
**ACORN**

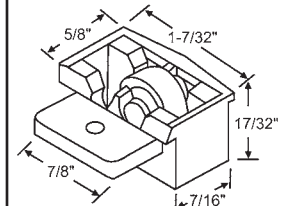

**900-10416**  
9/16" Dia. Steel Ball  
Bearing Wheel

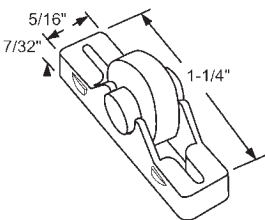

**52-728**  
9/16" Dia. Brass Wheel with  
Stainless Steel Axle

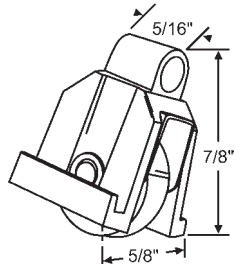

**52-931**  
9/16" Stainless Steel Flat Wheel

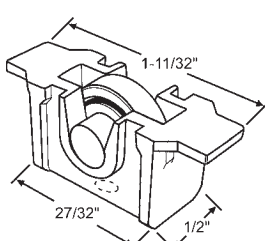

**52-553**  
9/16" Dia. Steel Ball  
Bearing Wheel.

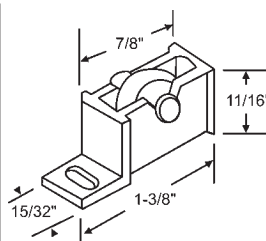

**52-680**  
9/16" Dia. Nylon Wheel  
**REYNOLDS**

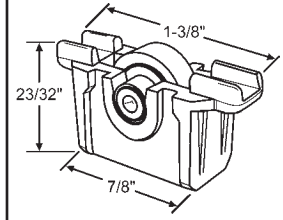

**900-19996**  
9/16" Dia. Steel Ball  
Bearing Wheel.

# WINDOW REPLACEMENT HARDWARE

## SLIDING WINDOW ROLLERS WITH PLASTIC HOUSING

Sliding window rollers in order by roller diameter, length and width.

**9/16"**

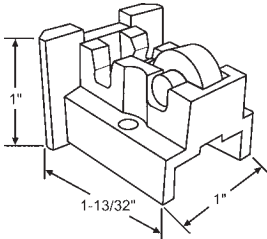

**52-535**

9/16" Dia. Brass Wheel. Black

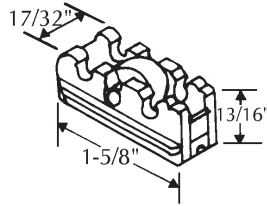

**52-625OLD**

9/16" Metal Ball Bearing Wheel

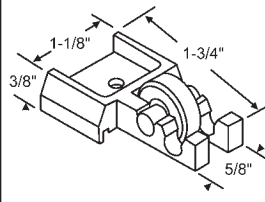

**900-8512A**

9/16" Dia. Flat Metal Wheel  
w/Separate Axle  
**CAPITOL**

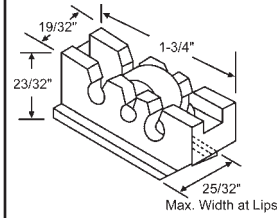

**52-622**

9/16" Dia. Metal Wheel  
**CAPITOL**

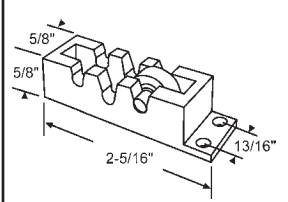

**52-808**

9/16" Dia. Flat Metal Wheel  
w/Separate Axle  
**CAPITOL**

**19/32"**

**5/8"**

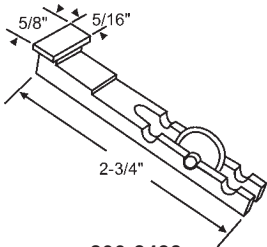

**900-8423**

9/16" Dia. Nylon Convex Wheel  
w/Fixed Axle

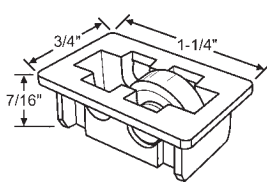

Part #	Wheel Size
900-12811	9/16"
900-12811HD	5/8"

Metal Ball Bearing Wheel

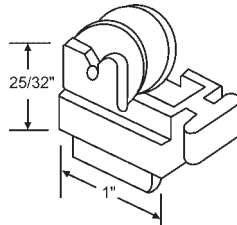

**52-642**

19/32" Dia. Metal Wheel

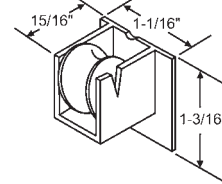

Part #	Hand
52-699LH	Shown
52-699RH	Opposite

5/8" Dia. Metal Wheel  
w/Separate Axle

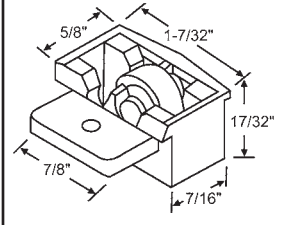

**900-10416NS**

5/8" Dia. Steel  
Ball Bearing Wheel

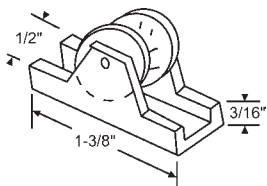

**52-671**

5/8" Dia. Metal Wheel  
**ROLLYSON**

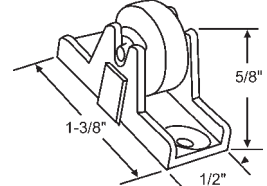

**900-68**

5/8" Dia. Flat Steel Wheel  
w/Separate Axle

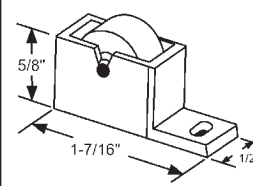

**900-1295**

5/8" Dia. Flat Brass Wheel  
w/Separate Stainless Steel Axle

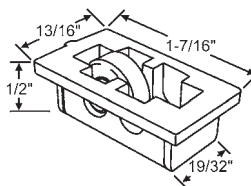

**52-676HD**

5/8" Dia. Ball Bearing  
Metal Wheel  
**ACORN**

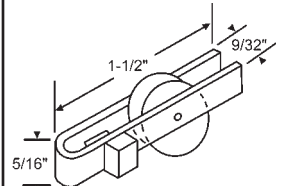

**52-626**

5/8" Dia. Nylon Wheel

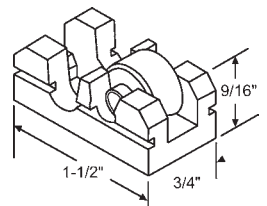

**900-20066A**

5/8" Dia. Metal Wheel

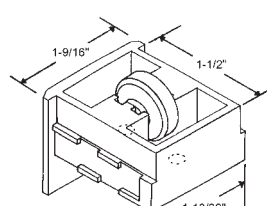

**52-714**

Cam and Roller Assembly  
5/8" Dia. Ball Bearing Wheel

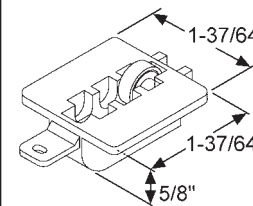

**52-805**

5/8" Dia. Flat Metal Ball Bearing  
Wheel w/Fixed Axles  
**ACORN**

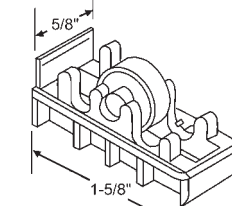

Part #	Color
900-8245A	Black
900-8245WA	White

5/8" Dia. Ball Bearing  
Metal Wheel  
**ACORN**

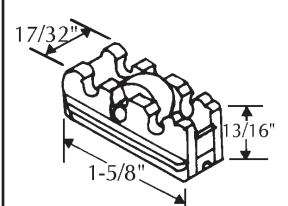

**52-625OLD-BB**

5/8" Dia. Steel Ball Bearing  
Wheel

# WINDOW REPLACEMENT HARDWARE

## SLIDING WINDOW ROLLERS WITH PLASTIC HOUSING

Sliding window rollers in order by roller diameter, length and width.

5/8"

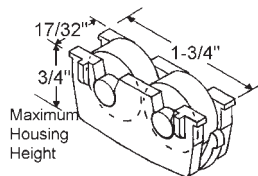

**900-1797A**  
Two 5/8" Dia. Metal Wheels  
White  
**SEASONALL**

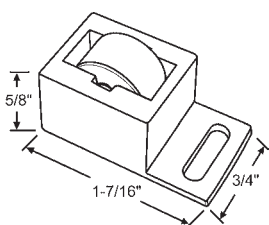

**900-1296**  
5/8" Dia. Brass Wheel. Stainless  
Steel Axle

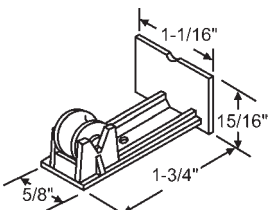

Part #	Hand
52-702	Shown
52-701	Opposite

5/8" Dia. Metal Wheel with  
Separate Axle

**ALSCO/SUGARCREEK**

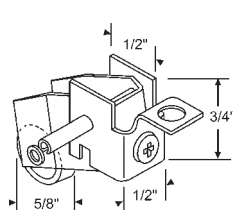

**900-13358**  
5/8" Dia. Flat Ball Bearing  
Steel Wheel

11/16"

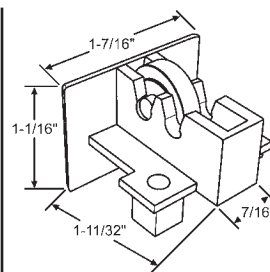

Part #	Color
900-16113	Black
900-16113W	White

11/16" Dia. Flat Ball Bearing  
Wheel and Fixed Axle

23/32"

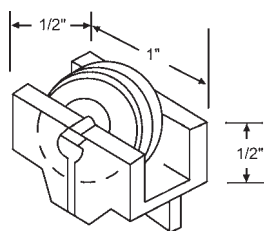

**52-609**  
23/32" Dia. Flat Nylon Wheel  
**CROSSLY**

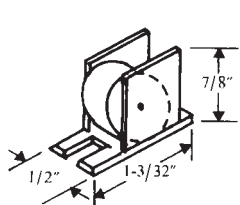

**52-623**  
23/32" Dia. Nylon Wheel

3/4"

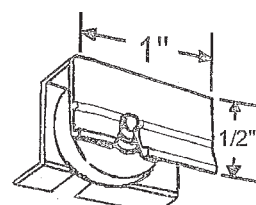

**52-694**  
3/4" Dia. Flat Nylon Ball Bearing Wheel  
**PREMIERE**

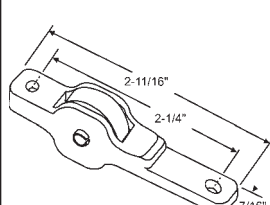

**900-20814**  
3/4" Dia. Flat Nylon Wheel

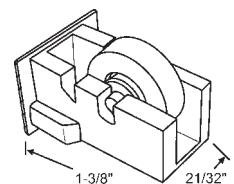

Part #	Description
52-950	Nylon Wheel
52-950BRS	Brass Wheel

3/4" Dia. Wheel  
**SECURITY**

## WEEP COVERS

25/32"

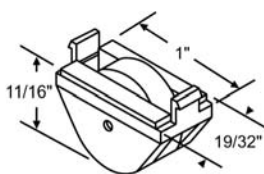

**900-17156**  
25/32" Dia. Wheel

7/8"

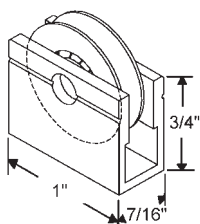

Part #	Description
900-10693	Nylon Wheel
900-10693M	Steel Wheel

7/8" Dia. Wheel

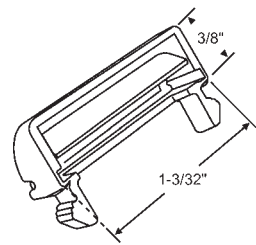

Part #	Color
900-20137	White
900-20137BE	Beige

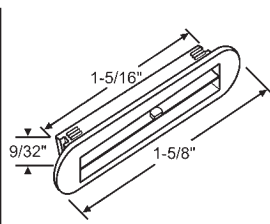

**85-1133ABG**  
Bronze  
**PGT**

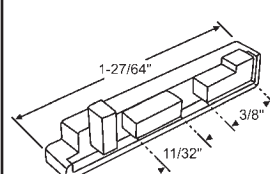

**900-2478**  
White

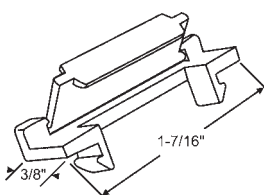

Part #	Color
900-17790W	White
900-17790	Beige
900-17790BL	Black

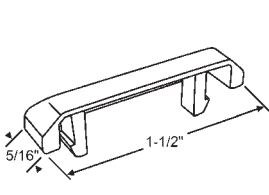

**85-879W**  
White

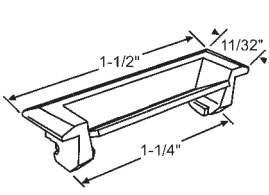

Part #	Color
85-742BG	Beige
85-742W	White

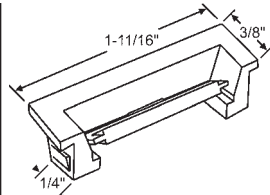

Part #	Color
85-730	Beige
85-730BW	Blue White
85-730WW	Warm White

**ACORN**

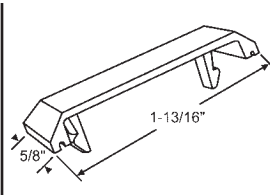

Part #	Color
900-19761	Beige
900-19761W	White

**VINYL BUILDING PRODUCTS**



# WINDOW REPLACEMENT HARDWARE

## WEEP COVERS

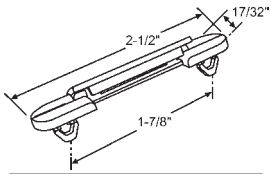

Part #	Color
60-711	White
60-711B	Black
60-711BE	Beige

**BETTER-BILT**

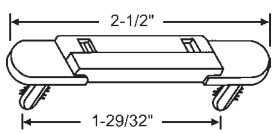

Part #	Color
900-19413W	Bright White
900-19413BG	Beige
900-19413B	Black
900-19413BR	Brown

**ROLLYSON/NORANDEX**

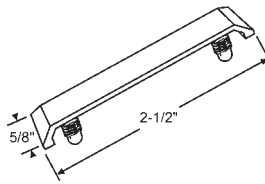

Part #	Color
900-21193	Beige
900-21193B	Black
900-21193W	White

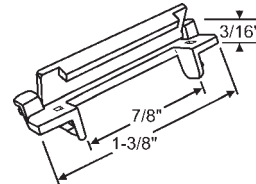

Part #	Color
900-19417W	White
900-19417BZ	Bronze

**PGT**

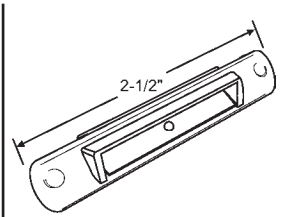

**52-989**  
White  
**PGT**

## SLIDING WINDOW WHEELS

Roller Diagram

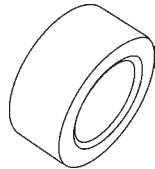
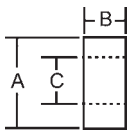

52-693		
A	B	C
7/16"	3/16"	1/4"

Flat Metal



52-619		
A	B	C
9/16"	7/32"	5/16"

Brass

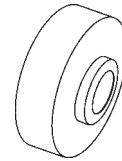

52-683R				
A	B	C	D	E
1/2"	5/32"	1/8"	1/32"	15/64"

Nylon

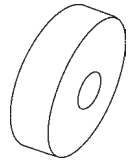

52-634		
A	B	C
17/32"	9/64"	1/8"

Nylon

## SLIDING WINDOW WHEELS W/FIXED AXLE



900-10189		
A	B	C
9/16"	13/16"	3/16"

Steel Ball Bearing Wheel

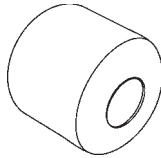

900-5704		
A	B	C
7/16"	7/16"	3/16"

White Nylon with Molded Axle

Roller Diagram

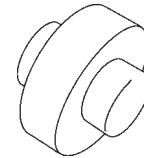
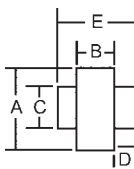

900-8618				
A	B	C	D	E
9/32"	3/32"	5/32"	1/16"	7/32"

Nylon Vent

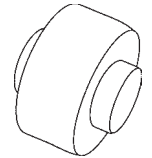

900-10418				
A	B	C	D	E
3/8"	3/16"	3/16"	1/16"	5/16"

Nylon

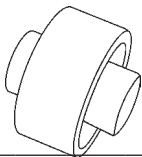

900-9814W			
A	B	C	E
25/64"	3/16"	3/16"	3/8"

Nylon with Offset Axle

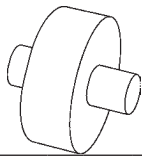

900-2041				
A	B	C	D	E
7/16"	5/32"	1/8"	1/8"	13/32"

Nylon

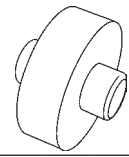

52-631				
A	B	C	D	E
1/2"	11/64"	3/16"	5/32"	25/64"

Stainless Steel

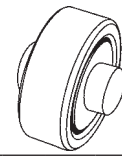

900-9764				
A	B	C	D	E
17/32"	3/16"	3/16"	3/32"	3/8"

Steel with Ball Bearings

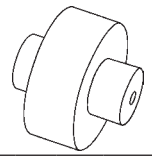

52-679				
A	B	C	D	E
9/16"	1/4"	1/4"	1/8"	1/2"

Nylon

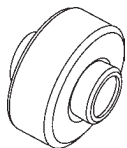

11-147				
A	B	C	D	E
9/16"	7/32"	1/4"	9/64"	7/16"

Steel with Ball Bearings

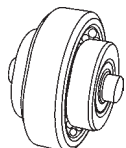

900-15444A				
A	B	E	H	I
5/8"	3/16"	3/8"	1/2"	1/8"

Steel with Ball Bearings

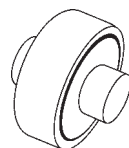

900-9564				
A	B	C	D	E
5/8"	1/4"	1/4"	1/8"	1/2"

Steel with Ball Bearings  
**ACORN**

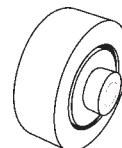

52-982				
A	B	C	D	E
5/8"	7/32"	3/16"	3/32"	3/8"

Steel with Ball Bearings  
**PAN AM**

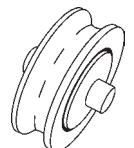

52-703R				
A	B	C	D	E
3/4"	1/4"	5/32"	3/32"	1/2"

Concave Nylon with Steel Hub and Ball Bearings

# WINDOW REPLACEMENT HARDWARE

## SLIDING WINDOW WHEELS W/FIXED AXLE

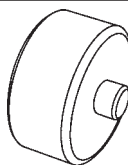

52-937W				
A	B	C	D	E
1/2"	1/4"	1/8"	1/16"	3/8"

Brass  
**PGT**

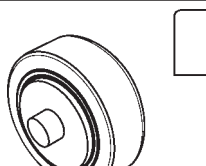

11-229				
A	C	D	H	I
23/32"	5/16"	1/4"	1/2"	5/32"

Nylon Ball Bearing with Axle

Roller Diagram

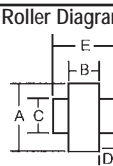

Axle Diagram

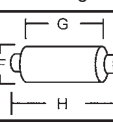
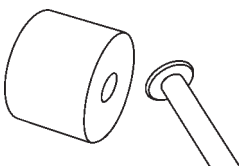
52-653				
A	B	C	H	I
3/8"	9/32"	3/32"	19/32"	3/32"

Nylon with Aluminum Axle

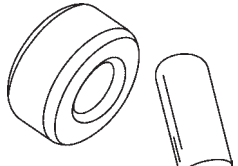

52-628				
A	B	C	F	H
29/64"	7/32"	3/16"	3/16"	1/2"

Steel

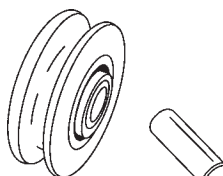

52-651					
A	B	C	E	F	H
5/8"	13/64"	1/8"	1/4"	1/8"	3/8"

Ball Bearing Roller with Axle

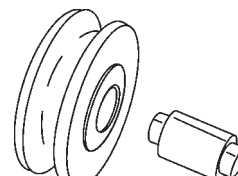

52-652							
A	B	C	E	F	G	H	I
5/8"	13/64"	3/16"	7/32"	3/16"	1/4"	3/8"	1/8"

Nylon Roller with Metal Axle

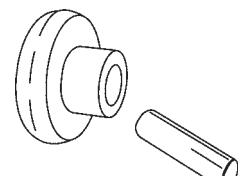

52-610					
A	B	C	D	H	I
1/2"	1/8"	1/8"	5/32"	13/32"	1/64"

Nylon with Steel Axle

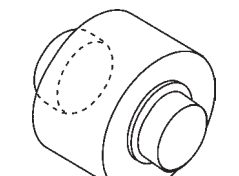

52-688				
F	G	I	D	H
1/2"	9/32"	1/4"	1/16"	27/64"

Nylon

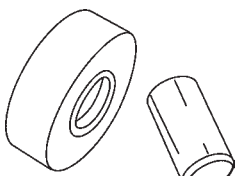

900-11791W				
A	B	C	D	E
17/32"	13/64"	3/16"	3/32"	3/8"

Steel

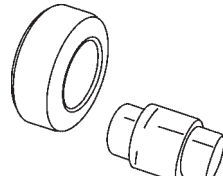

52-621					
A	B	C	F	G	H
9/16"	1/4"	1/4"	5/16"	1/4"	1/2"

Aluminum with Steel Axle

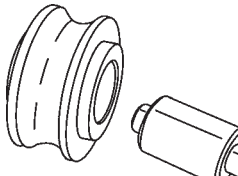

52-700							
A	B	C	E	F	G	H	I
19/32"	3/8"	1/4"	23/64"	1/4"	3/8"	1/2"	1/8"

Concave Metal. Axle Included

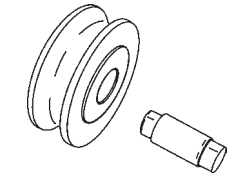

52-703RNEW							
A	B	C	E	F	G	H	I
3/4"	1/4"	3/16"	3/16"	3/16"	5/16"	1/2"	5/32"

Nylon with Brass Axle

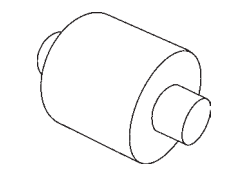

900-11416R				
F	G	I	D	H
5/16"	19/64"	1/8"	3/32"	15/32"

Steel

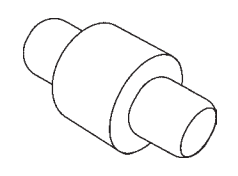

900-8952				
F	G	I	D	H
5/16"	1/4"	13/64"	3/16"	21/32"

Steel

## STORM CAM LATCH

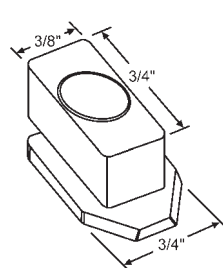

**52-868**  
**ACORN 2330 SERIES**

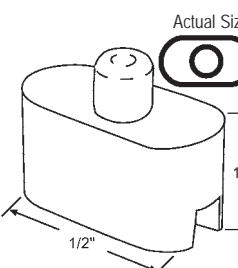

**52-668**  
**ADOR HILTE**

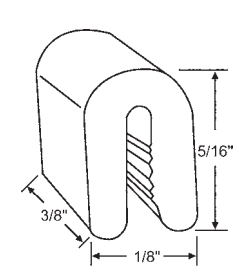

**52-725**  
**ACORN**

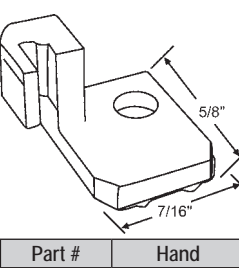

Part #	Hand
900-9556RH	Shown
900-9556LH	Opposite

**ACORN**

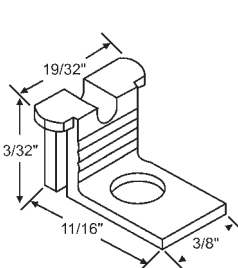

**900-5215**  
**KING**

## SLIDER GUIDES

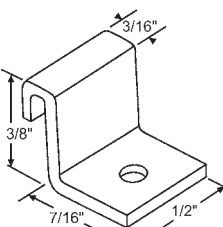

**900-8380**  
**KELLER/AIRCONTROL**

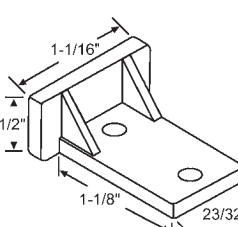

**900-5159**

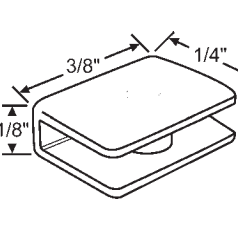

**52-814**  
Nylon Guide  
**PAN AM**

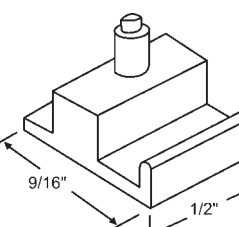

**52-669**

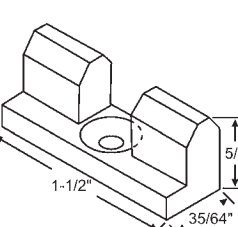

**900-1987**

# WINDOW REPLACEMENT HARDWARE

## SLIDER GUIDES

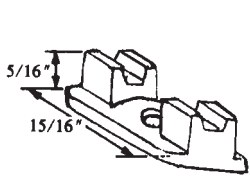

**900-5766**

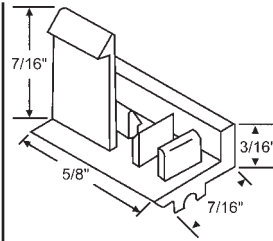

**52-636**  
RH Storm Slider

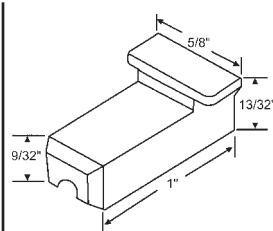

**52-639**

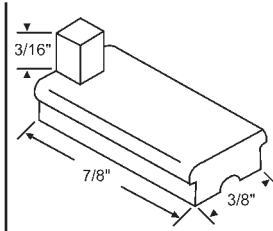

**900-15187**

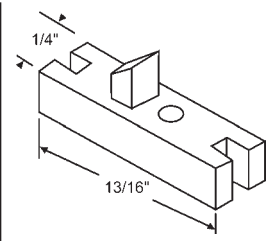

**900-5593**  
**COLE SEWELL**

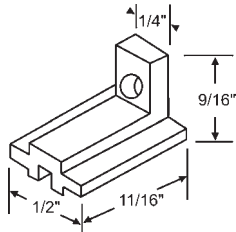

**52-674**

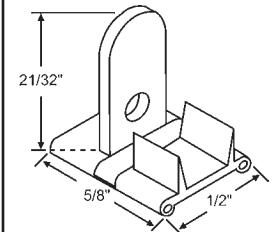

**900-11181**  
Black

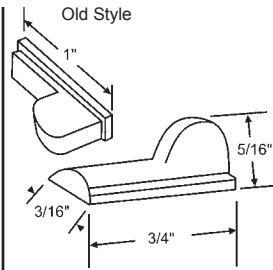

**900-6902**  
**CROSSLY/LUMIDOR**

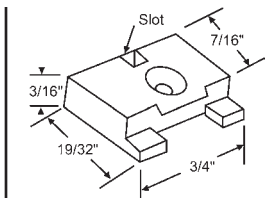

Part #	Color	Slot
52-673	Natural	Yes
52-673B	Black	Yes
52-673OLD	Natural	No
52-673B-OLD	Black	No

Nylon. Includes Screws  
**CROWN**

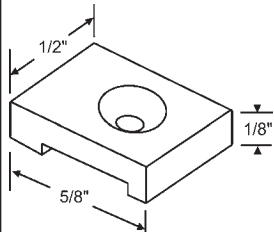

**52-677**  
Nylon  
**REYNOLDS**

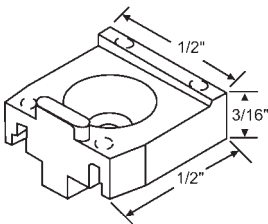

**900-20307B**  
Black

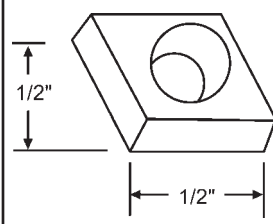

**52-635**  
Insert Retainer

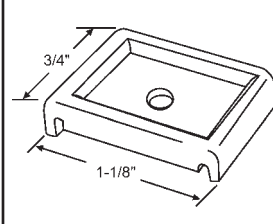

**900-11537**  
Rail Slide

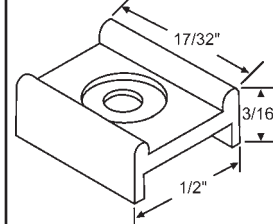

**900-5613**

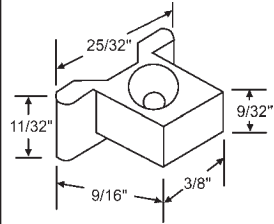

**52-602**  
**KELLER**

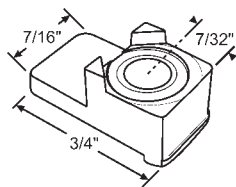

**900-6901**  
Nylon Face Guide. Black  
**ATRIUM/PHILIPS**

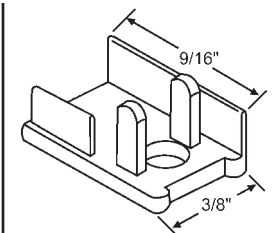

**900-20104**  
Interlock Cap  
**BETTER-BILT**

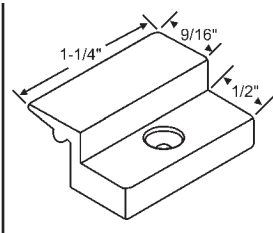

Part #	Color
900-15598	Black
900-15598W	White

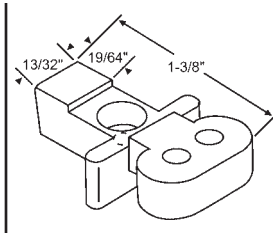

**900-14207**

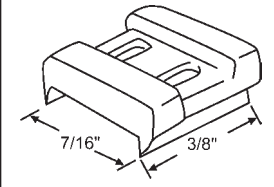

**900-21136**  
**CAPITOL**

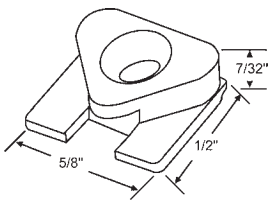

**52-818**  
Slider Guide

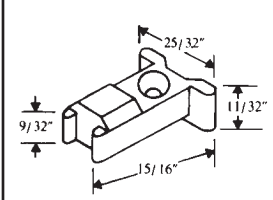

**52-601**  
**KELLER**

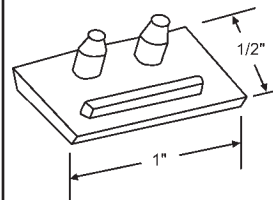

**52-664**  
**CROSSLY**

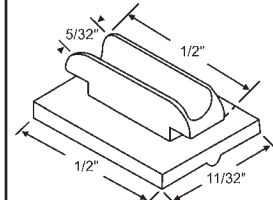

**52-665**  
Insert for 52-667

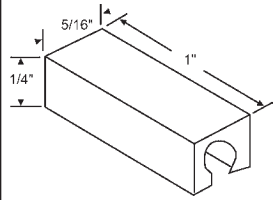

**52-829**  
Nylon Spacer, Black  
**ACORN**

# WINDOW REPLACEMENT HARDWARE

## SLIDER GUIDES

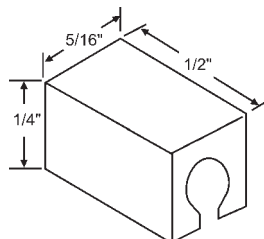

**52-828**  
Nylon Spacer, Black  
**ACORN**

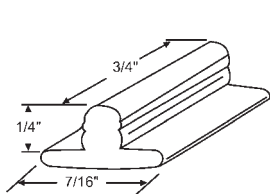

**52-706**

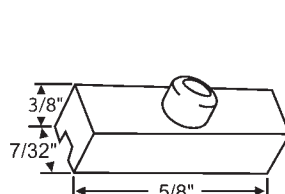
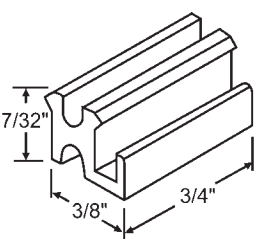

**52-720**  
Repair Kit (2 of each)  
**ALENCO**

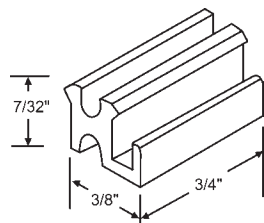
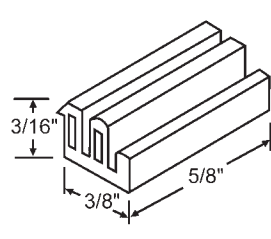

**52-608**  
**ALENCO**

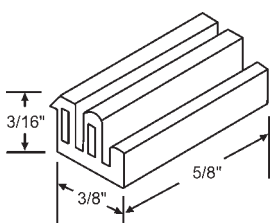

**52-670**  
Nylon  
**ALENCO**

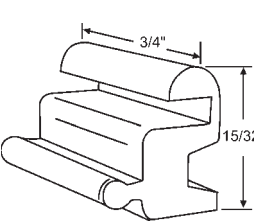

**52-845**

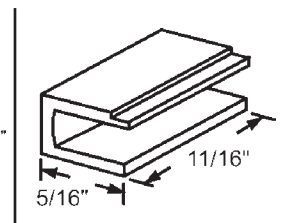

**900-6894**  
Sash Guide

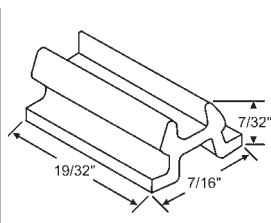

**900-1105**  
Gray

## PIVOT SHOE

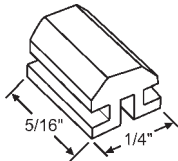

**52-846**  
White  
**PAN AM/BINNINGS**

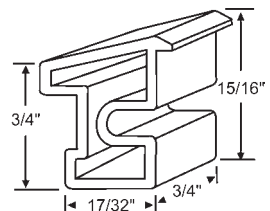

**52-7000**  
Sash Lift Stop, Black  
**ACORN**

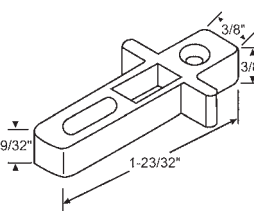

**52-600**

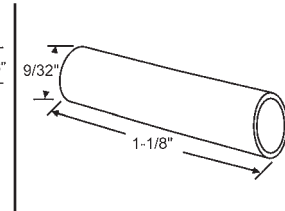

**52-633**  
Slider Pressure Tubes

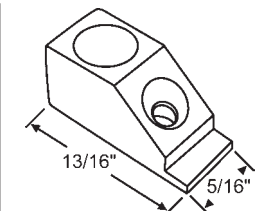

**900-5749**  
Nylon  
**MALTA**

## SLIDE BOLT

## ANTI-RATTLE PLUG

## GUIDE BUTTON

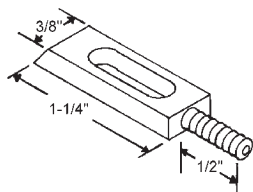

**900-1888**  
White Plastic

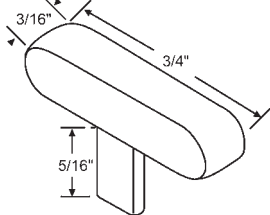

**900-2405**  
Anti-Rattle Plug

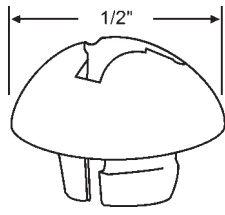

**900-9195**  
**CAPITOL**

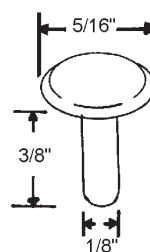

**900-2498**

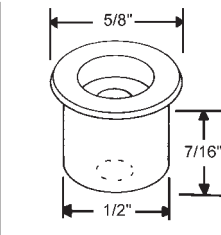

Part #	Color
900-20046BG	Beige
900-20046	White

Reinforcing Button

## ANGLES / CORNERS

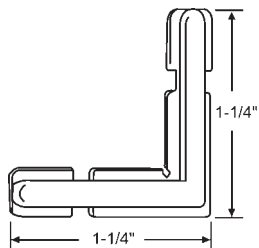

**52-605**  
Slider Guide Angle  
Plastic

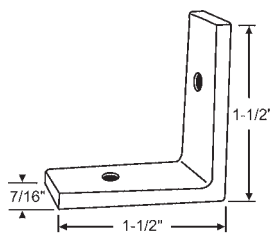

**52-604**  
Slider Guide Angle  
Aluminum

# WINDOW REPLACEMENT HARDWARE

## ANGLES / CORNERS

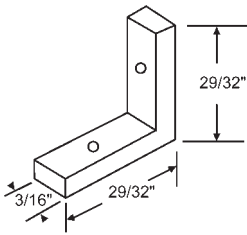

**52-603**  
Slider Corner Angle  
Die Cast

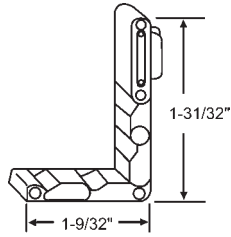

**52-667**  
Slider Corner Key  
Die Cast with Plastic Insert  
**REYNOLDS/PORTALUME**

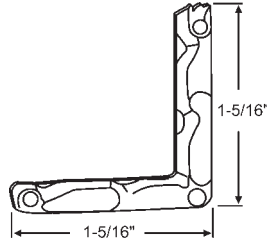

**52-672**  
Slider Corner Key  
Die Cast

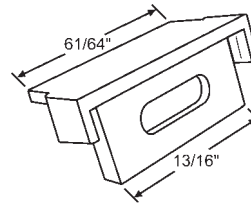

**52-992**  
End Cap. White  
**PGT**

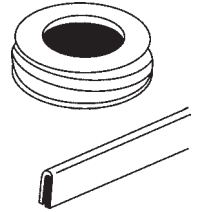

**52-705**  
Sliding Window Repair Track.  
Vinyl. Install over worn or  
damaged tracks. Sold in 100 ft.  
rolls only, Gray

## MISCELLANEOUS

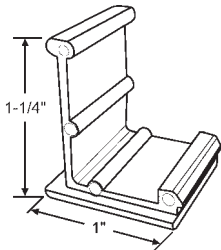

**52-990**  
End Cap. White  
**PGT**

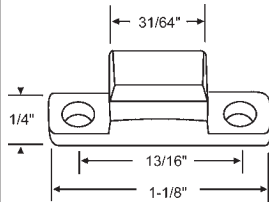

**900-2003**  
Nylon Bottom Rail Slide  
Black

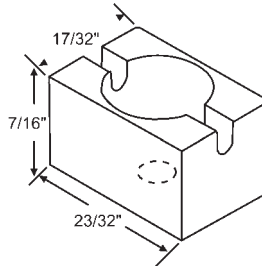

**900-5571**  
Glide Block  
**ALENCO/KRESTMARK/  
KELLER**

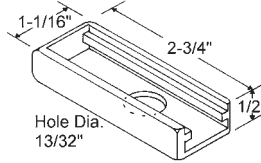

Part #	Color
900-20099BE	Beige
900-20099B	Black
900-20099W	White

Slide Bolt Cover

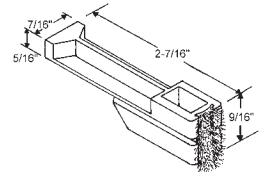

**900-20105**  
Anti-Draft Block

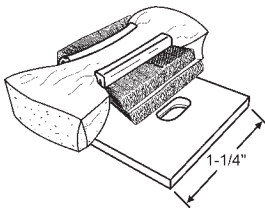

**900-11534**  
Inerlock Seal Assembly. Red  
**CAPITOL**

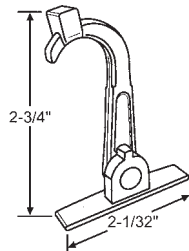

**52-986**  
Sliding Window Pull. Black Plastic  
**CROSSLY**

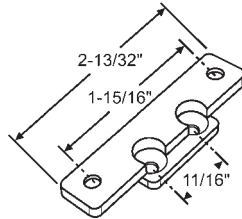

**900-22206**  
Transom Bracket. White Plastic  
**ACORN/REHAU**

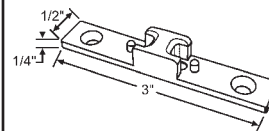

**52-1126**  
Fixed Mounting Rail Bracket  
**PGT**

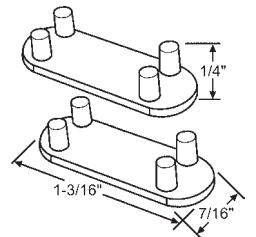

**52-1127**  
Frame Plug  
**PGT**

## FASTENERS

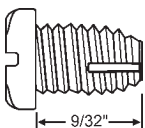

**20-518**  
Pan Head Self Tapping Screw  
Type #1. 10-24 x 9/32"

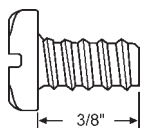

**20-515**  
Pan Head Screw. 10-24 x 3/8"  
Bronze

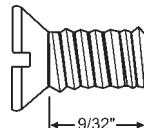

**20-517**  
Flat Head Screw. 10-24 x 9/32"

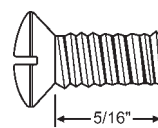

**20-516**  
Oval Head Screw. 10-24 x 5/16"  
Bronze

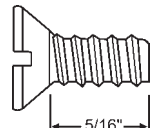

**20-519**  
Flat Head Screw. 12-24 x 5/16"

# WINDOW REPLACEMENT HARDWARE

## PROJECT-OUT ONE HOLE CAM HANDLES

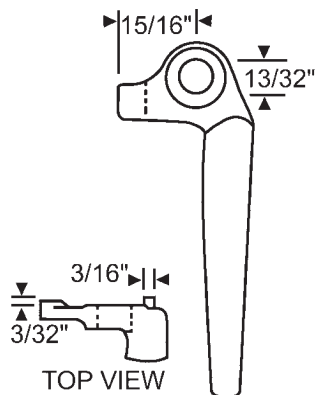

Part #	Hand	Finish
32-208	Shown	Dark Bronze
32-207	Opposite	Dark Bronze

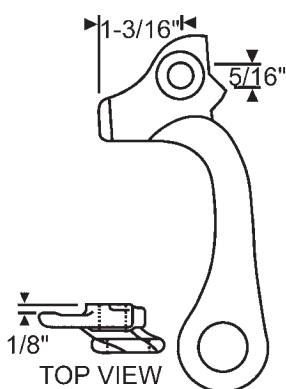

Part #	Finish
32-238	Copper
Water Rolled Finish	

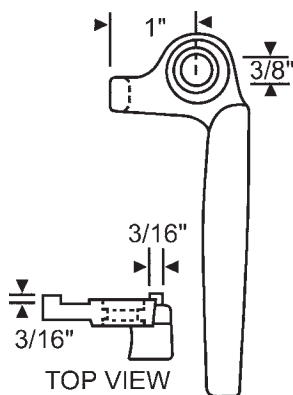

Part #	Hand	Finish
32-254	Shown	Dark Brown
32-255	Opposite	Dark Brown

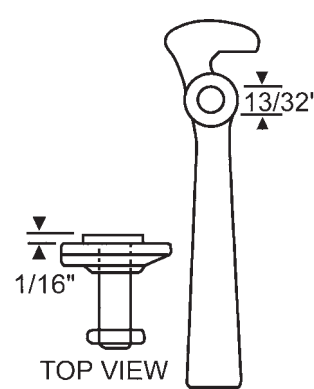

Part #	Finish
32-222	Aluminum

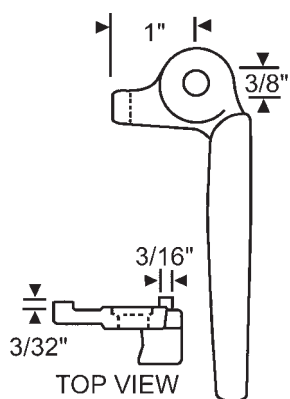

Part #	Finish
32-223	Light Bronze

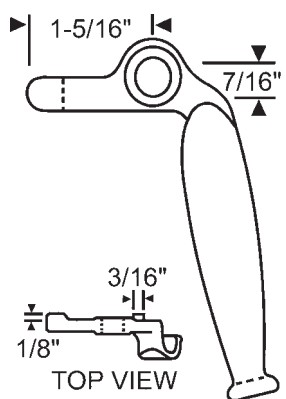

Part #	Hand	Finish
32-230	Shown	Dark Bronze
32-231	Opposite	Dark Bronze

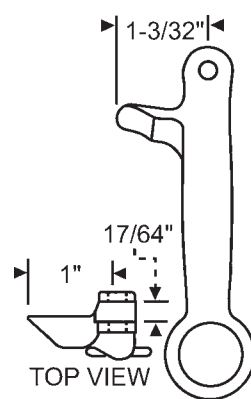

Part #	Finish
32-232	Dark Bronze

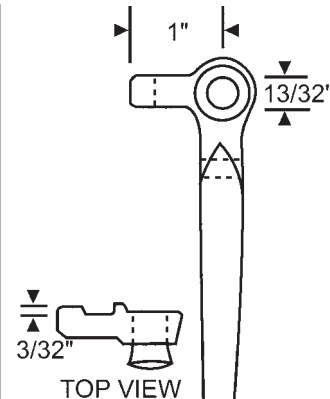

Part #	Hand	Finish
32-236	Shown	Dark Bronze
32-237	Opposite	Dark Bronze

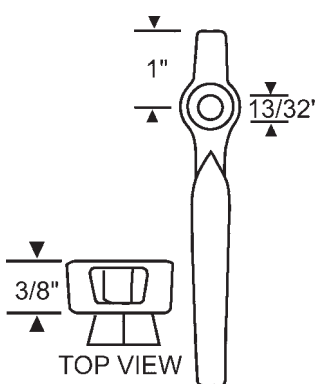

Part #	Finish
32-239	Dark Bronze

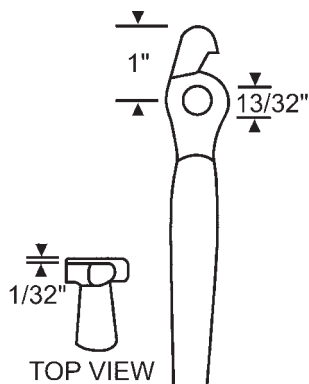

Part #	Finish
32-240	Dark Bronze

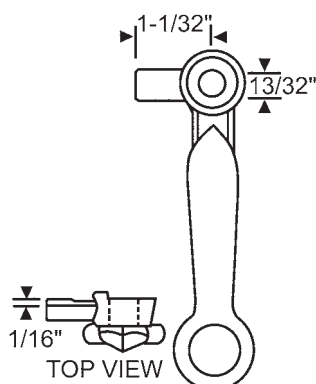

Part #	Hand	Finish
32-272	Shown	Aluminum
32-214	Opposite	Aluminum

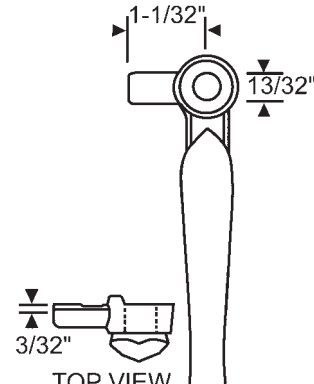

Part #	Hand	Finish
32-247	Shown	Dark Bronze
32-248	Opposite	Dark Bronze

# WINDOW REPLACEMENT HARDWARE

## PROJECT-OUT ONE HOLE CAM HANDLES

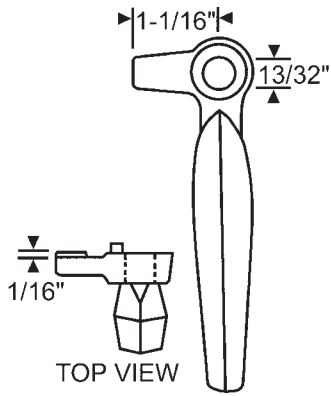

Part #	Hand	Finish
32-249	Shown	Copper
32-250	Opposite	Copper

Water Rolled Finish

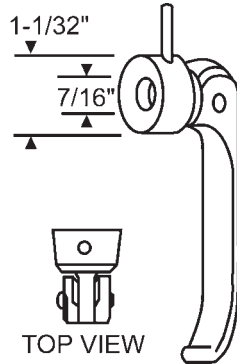

Part #	Finish
32-288	Light Bronze
32-288A	Aluminum

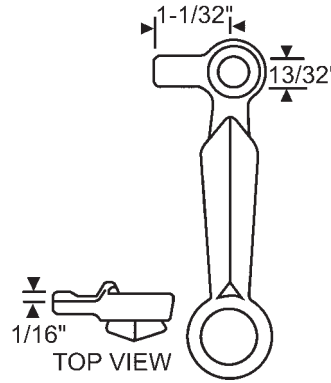

Part #	Finish
32-215	Dark Bronze

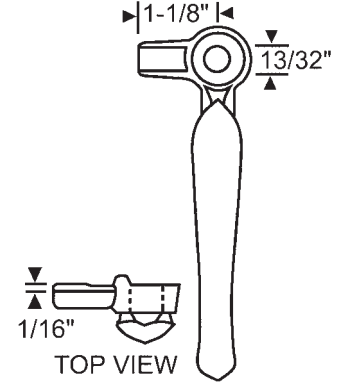

Part #	Hand	Finish
32-219	Shown	Bronze
32-217	Opposite	Bronze

## PROJECT-OUT MOUNTING HARDWARE FOR CAM HANDLES

### 32-204 and 20-022

Use on: 32-207, 32-208, 32-215, 32-236, 32-237, 32-239, 32-240, 32-247, 32-248, 32-273

### 32-204A and 20-022A

Use on: 32-214, 32-216, 32-217, 32-218, 32-219, 32-222, 32-272



Part #	Finish
32-204	Dark Bronze
32-204A	Aluminum

Clevis

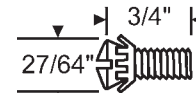

Part #	Finish
20-022	Dark Bronze
20-022A	Aluminum

Clevis Screw with Lock Washer  
Thread Size: 1/4 -20

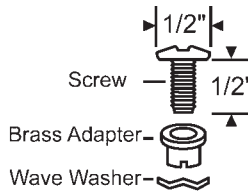

**20-027**  
Dark Bronze Finish. Thread Size: 1/4 -20  
Use on 32-254 and 32-255



**900-9452**  
Clevis Lock Washer  
Use on 32-230 and 32-231

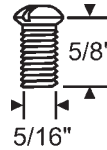

**900-797**  
Clevis Screw, Dark Bronze  
Use on 32-230 and 32-231

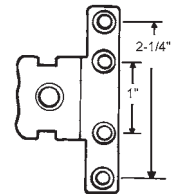

**900-7979**  
Mounting Bracket, Dark Bronze  
Use on 32-230 and 32-231

## PROJECT-OUT TWO HOLE CAM HANDLES

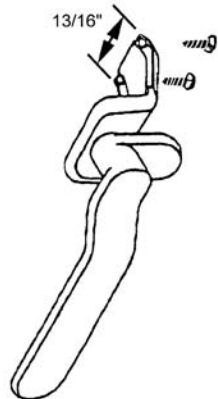

Part #	Hand	Finish
32-433LH	Shown	Black
32-433RH	Opposite	Black

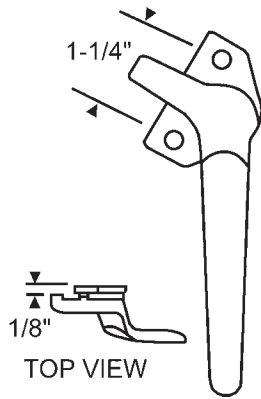

Part #	Hand	Finish
32-242	Shown	Dark Bronze
32-243	Opposite	Dark Bronze

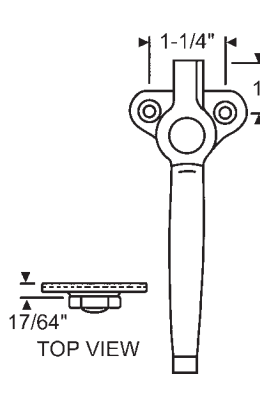

Part #	Finish
32-235	Dark Bronze

Use Screw 20-030

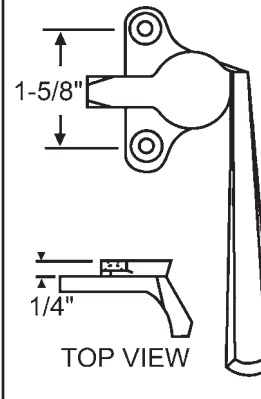

Part #	Hand	Finish
32-560RH	Shown	Aluminum
32-560LH	Opposite	Aluminum

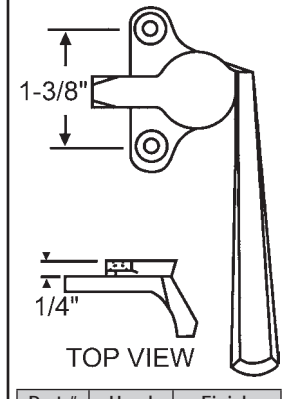

Part #	Hand	Finish
32-295	Shown	Light Bronze
32-294	Opposite	Light Bronze
32-295A	Shown	Aluminum
32-294A	Opposite	Aluminum

# WINDOW REPLACEMENT HARDWARE

## PROJECT-OUT TWO HOLE CAM HANDLES

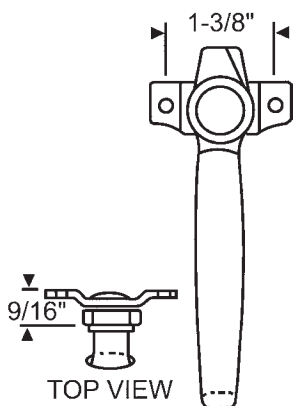

Part #	Finish
32-225	Dark Bronze

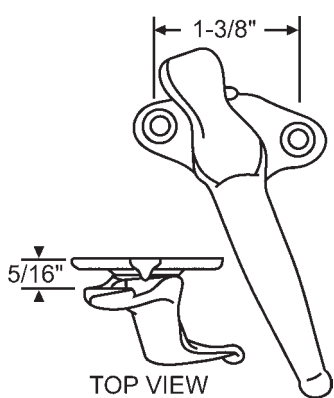

Part #	Finish
32-279	Dark Bronze

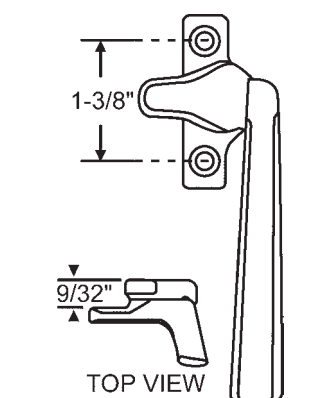

Part #	Hand	Finish
32-301	Shown	White Bronze
32-300	Opposite	White Bronze

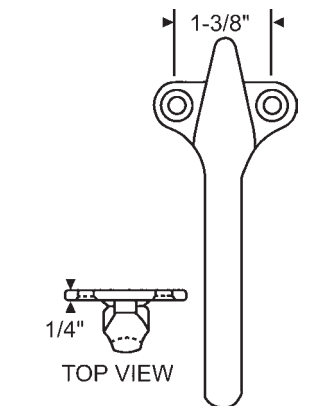

Part #	Finish
32-211	Satin Bronze

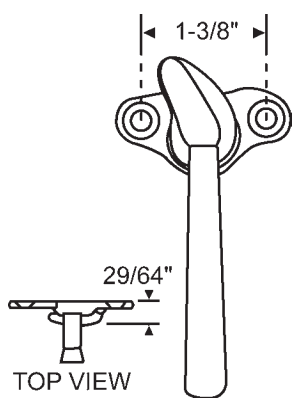

Part #	Finish
32-203	Dark Bronze

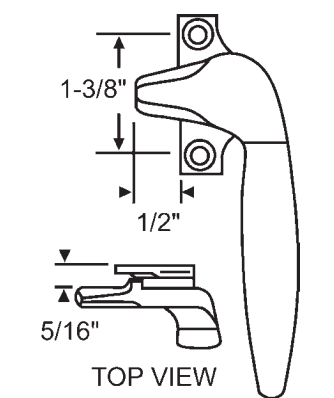

Part #	Hand	Finish
32-221	Shown	White Bronze
32-221DBZ	Shown	Dark Bronze
32-220	Opposite	White Bronze
32-220DBZ	Opposite	Dark Bronze

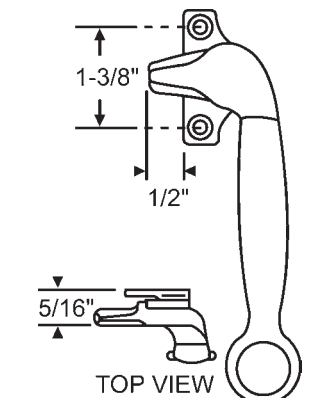

Part #	Hand	Finish
32-308	Shown	White Bronze
32-307	Opposite	White Bronze
32-307MB	Opposite	Medium Bronze

Pole Hole  
**EFCO**

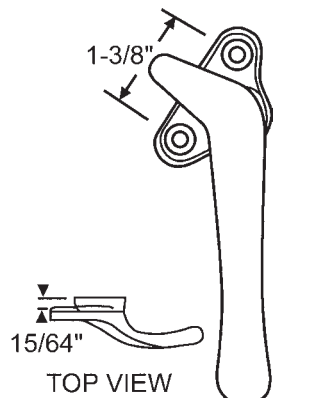

Part #	Hand	Finish
32-263	Shown	Water Rolled Copper
32-241	Opposite	Water Rolled Copper

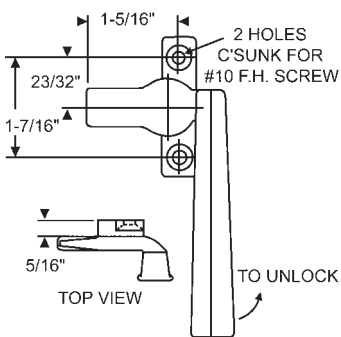

Part #	Hand	Finish
900-8959RH	Shown	White Bronze
900-8959LH	Opposite	White Bronze
900-8959RMB	Shown	Medium Bronze

Use with 900-9132 Keeper

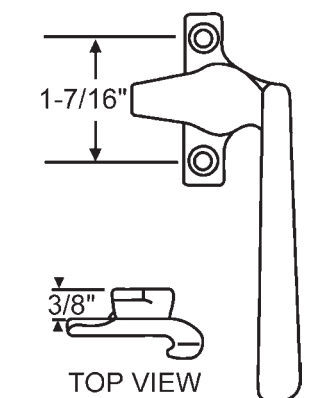

Part #	Hand	Finish
32-257	Shown	White Bronze
32-257LH	Opposite	White Bronze

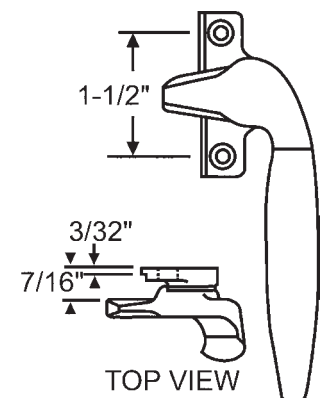

Part #	Hand	Finish
32-252	Shown	White Bronze
32-253	Opposite	White Bronze

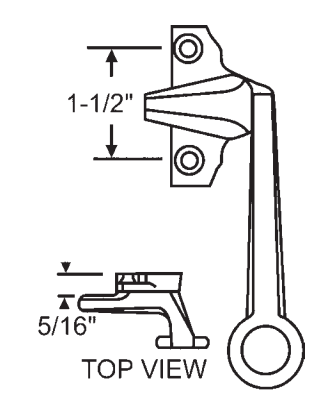

Part #	Finish
32-270	White Bronze

Pole Hole  
**WARE**



# WINDOW REPLACEMENT HARDWARE

## PROJECT-OUT TWO HOLE CAM HANDLES

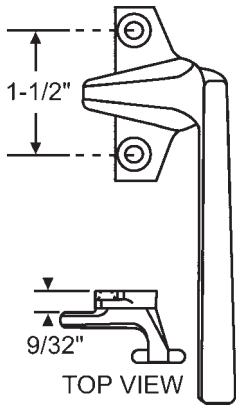

Part #	Hand	Finish
900-198LH	Opposite	White Bronze
900-198RH	Shown	White Bronze

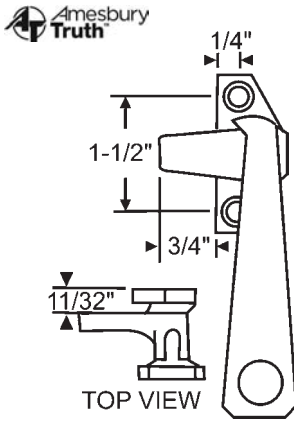

Part #	Hand	Finish
32-319-8	Shown	Chestnut Bronze
32-318-8	Opposite	Chestnut Bronze

Offset Base. Pole Hole. Die Cast

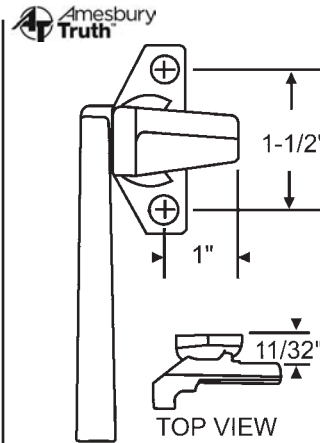

Part #	Hand	Finish
32-449-14	Shown	Cocoa Brown
32-448-14	Opposite	Cocoa Brown
32-449-9	Shown	Beige
32-448-9	Opposite	Beige

Offset Base. Die Cast

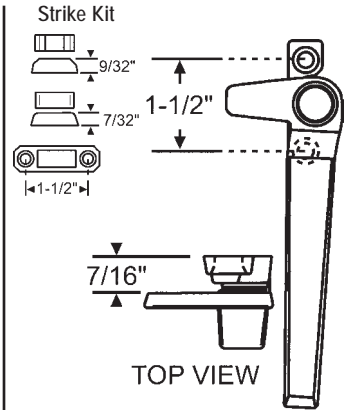

Part #	Finish
32-406RHB	Black

w/ Strike Kit

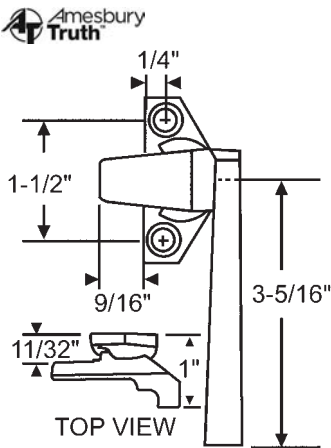

Part #	Hand	Finish
32-311-1	Shown	Bronze
32-311-3	Shown	White
32-311-7	Shown	Aluminum
32-311-8	Shown	Chestnut Bronze
32-311-10	Shown	Black
32-311-11	Shown	Red
32-310-1	Opposite	Bronze
32-310-3	Opposite	White
32-310-7	Opposite	Aluminum
32-310-8	Opposite	Chestnut Bronze
32-310-10	Opposite	Black
32-310-11	Opposite	Red

Offset Base. Die Cast

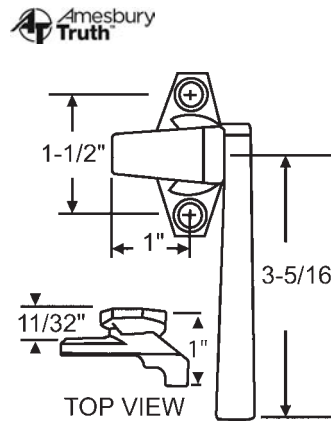

Part #	Hand	Finish
32-313-1	Shown	Bronze
32-313-3	Shown	White
32-313-7	Shown	Aluminum
32-313-12	Shown	Medium Bronze
32-312-1	Opposite	Bronze
32-312-3	Opposite	White
32-312-7	Opposite	Aluminum
32-312-12	Opposite	Medium Bronze

In Line Base. Die Cast

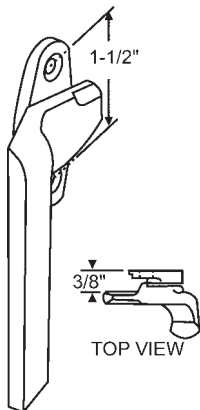

Part #	Finish
32-403	White
32-403BG	Beige

Plastic. Use Keeper 50-836  
**KASSON/KELLER**

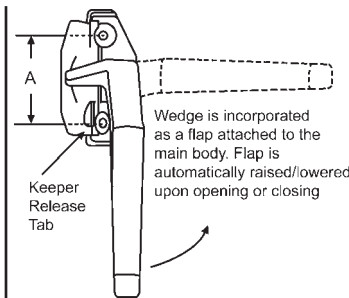

Part #	Hand	Finish	A
32-455RW	Shown	White	1-1/4"
32-455LW	Opposite	White	1-1/4"
32-455RB	Shown	Black	1-1/4"
32-455LB	Opposite	Black	1-1/4"
32-552RHW	Shown	White	1-1/2"
32-552LHW	Opposite	White	1-1/2"
32-552RHB	Shown	Black	1-1/2"
32-552LHB	Opposite	Black	1-1/2"

Wedgeless Cam Handle

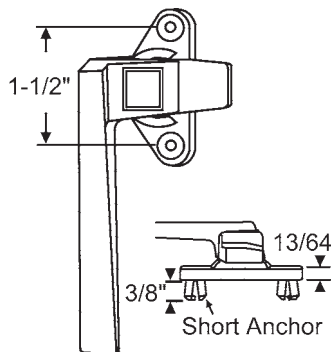

Part #	Hand	Finish
32-464LH	Shown	White
32-464RH	Opposite	White

Plastic

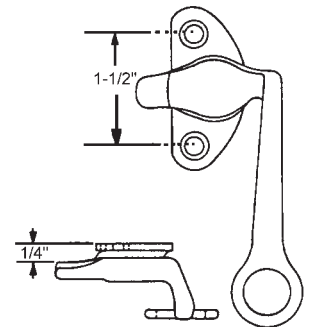

Part #	Finish
900-8988	Red Bronze

Pole Hole  
**BAYLEY**

# WINDOW REPLACEMENT HARDWARE

## PROJECT-OUT TWO HOLE CAM HANDLES

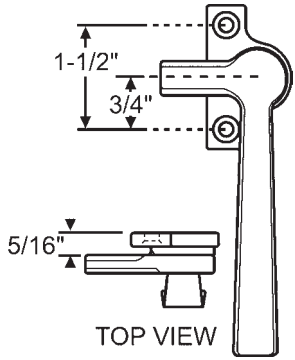

Part #	Hand	Finish
32-274B	Shown	Aluminum
32-275B	Opposite	Aluminum

Two Hole Replacement for  
32-274 & 32-245

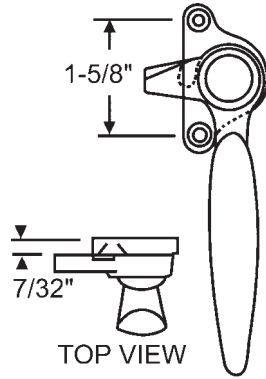

Part #	Finish
32-251	Copper

Water Rolled Finish  
Project Out Handle

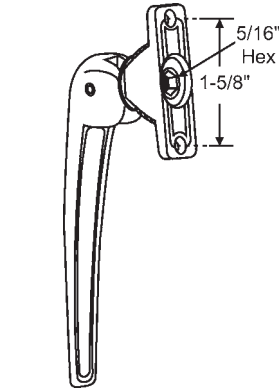

Part #	Finish
900-10729	Black Plastic with Die Cast Hex
900-10729WB	All White Bronze

**CLEARVIEW**

## PROJECT-OUT THREE & FOUR HOLE CAM HANDLES

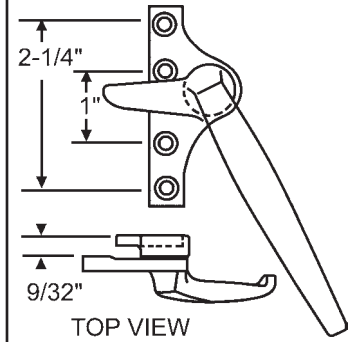

Part #	Hand	Finish
32-233	Shown	Red Bronze
32-234	Opposite	Red Bronze

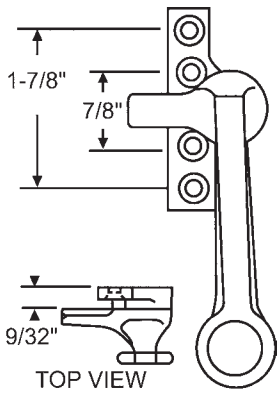

Part #	Finish
32-283	White Bronze

Pole Hole

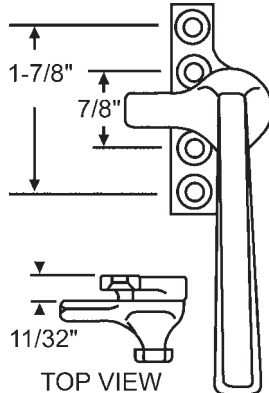

Part #	Hand	Finish
32-210	Shown	White Bronze
32-209	Opposite	White Bronze

**THORN**

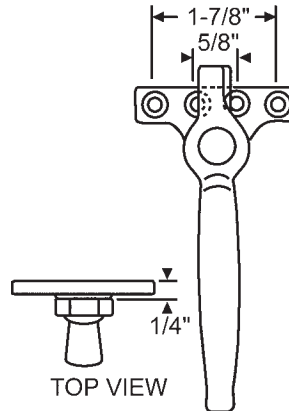

Part #	Finish
32-224	Red Bronze

Use Screw 20-030

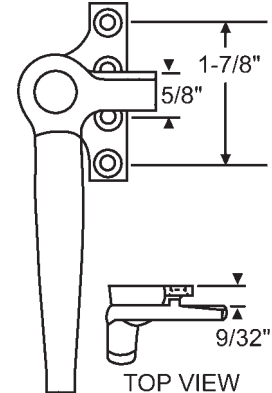

Part #	Hand	Finish
32-227	Shown	Dark Bronze
32-226	Opposite	Dark Bronze

## PROJECT-OUT INSIDE MOUNT CAM HANDLES

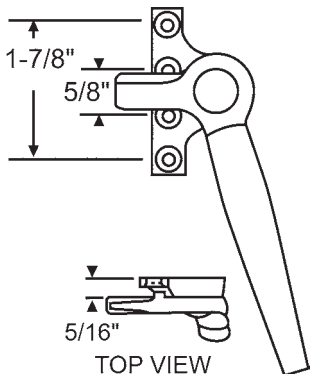

Part #	Hand	Finish
32-228DB	Shown	Dark Bronze
32-228	Shown	Red Bronze
32-229	Opposite	Red Bronze

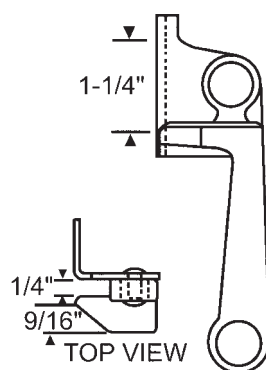

Part #	Finish
32-206	Copper

Water Rolled Finish

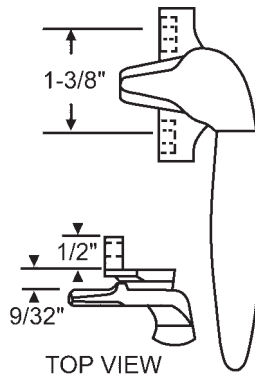

Part #	Hand	Finish
32-285	Shown	White Bronze
32-285LH	Opposite	White Bronze

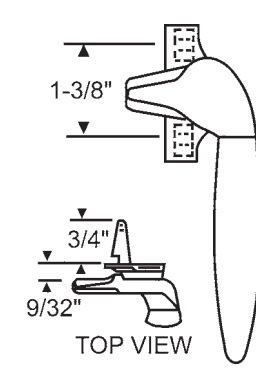

Part #	Hand	Finish
32-258	Shown	White Bronze
32-258LH	Opposite	White Bronze

# WINDOW REPLACEMENT HARDWARE

## PROJECT-OUT INSIDE MOUNT CAM HANDLES

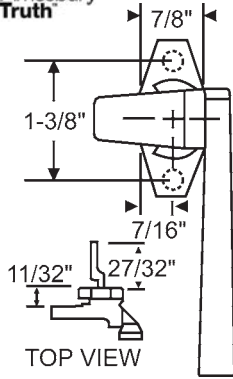

Part #	Hand	Finish
32-315-7	Shown	Aluminum
32-315-8	Shown	Chestnut Bronze
32-314-7	Opposite	Aluminum
32-314-8	Opposite	Chestnut Bronze

In Line Base. Die Cast

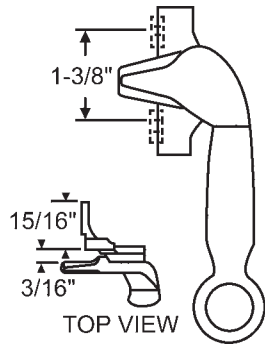

TOP VIEW

Part #	Hand	Finish
32-259RH	Shown	White Bronze
32-259LH	Opposite	White Bronze

with Pole Hole (shown)

Part #	Hand	Finish
900-18541RH	Shown	White Bronze
900-18541LH	Opposite	White Bronze

No Pole Hole

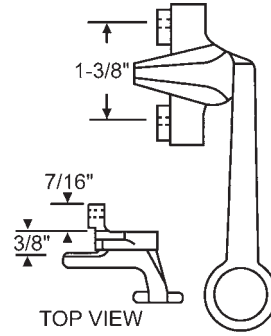

TOP VIEW

Part #	Finish
32-262	White Bronze

Holes Tapped 10-24

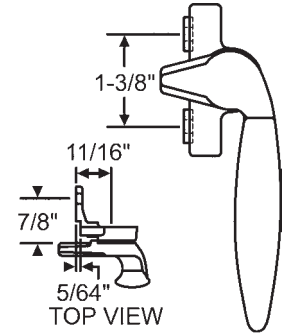

TOP VIEW

Part #	Hand	Finish
900-9798RH	Shown	White Bronze
900-9798LH	Opposite	White Bronze

## PROJECT-IN HANDLES

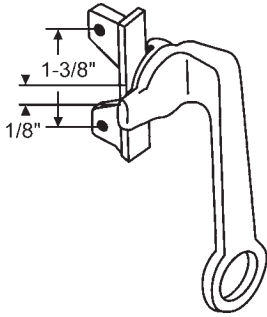

Part #	Hand	Finish
1206PR	Shown	Bronze
1206PL	Opposite	Bronze

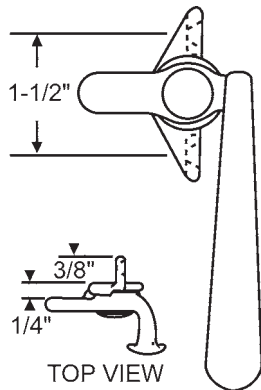

TOP VIEW

Part #	Finish
32-305	White Bronze

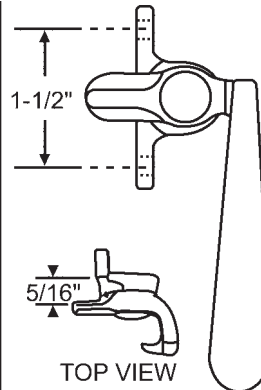

TOP VIEW

Part #	Finish
900-8601	White Bronze

Used with Keeper 50-726

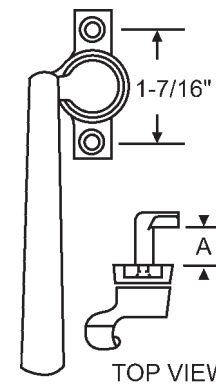

TOP VIEW

Part #	A	Finish
32-268	9/16"	White Bronze
32-268-.5	1/2"	White Bronze

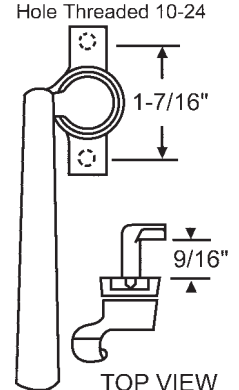

TOP VIEW

Part #	Hand	Finish
32-269LH	Shown	White Bronze
32-269RH	Opposite	White Bronze

Bottom Mount

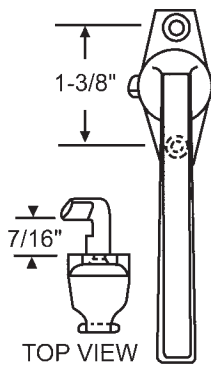

TOP VIEW

Part #	Hand	Finish
32-266	Shown	White Bronze
32-267	Opposite	White Bronze

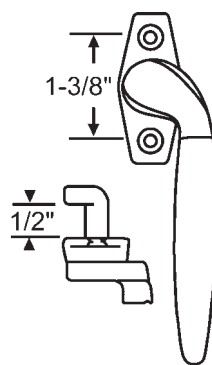

TOP VIEW

Part #	Hand	Finish
900-207RH	Shown	White Bronze
900-207LH	Opposite	White Bronze

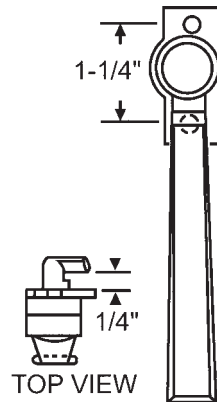

TOP VIEW

Part #	Finish
32-276	Copper

Water Rolled Finish

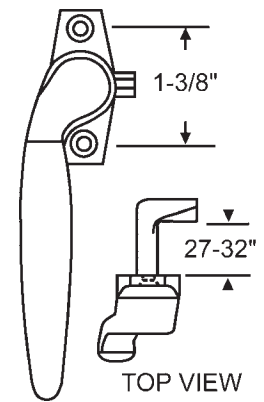

TOP VIEW

Part #	Finish
32-287	White Bronze

# WINDOW REPLACEMENT HARDWARE

## PROJECT-IN HANDLES

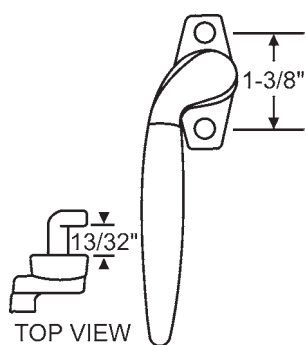

Part #	Finish
32-556	White Bronze

Top Mount

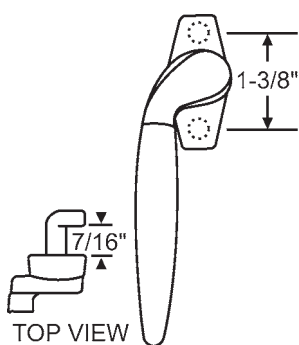

Part #	Finish
32-290	White Bronze

Bottom Mount

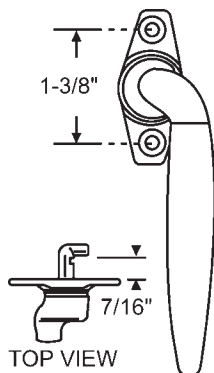

Part #	Hand	Finish
32-303	Shown	White Bronze
32-302	Opposite	White Bronze

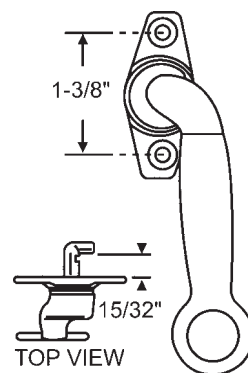

Part #	Hand	Finish
900-210RH	Shown	White Bronze
900-210LH	Opposite	White Bronze

Pole Ring

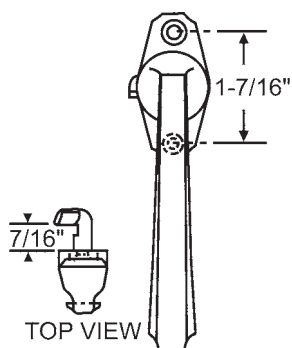

Part #	Hand	Finish
900-9799	Shown	Copper
900-9800	Opposite	Copper

**WARE**

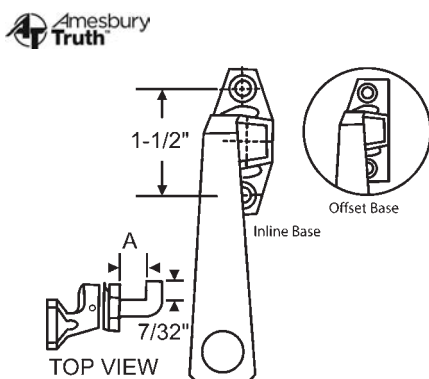

Part #	Finish	A	Base Type	Hand
32-341-8	Chestnut Bronze	7/16"	Offset	Shown
32-342-8	Chestnut Bronze	7/16"	Offset	Opposite
32-346-7	Aluminum	7/16"	In-line	Opposite
32-347-8	Chestnut Bronze	1/2"	In-line	Shown
32-348-8	Chestnut Bronze	1/2"	In-line	Opposite

Pole Ring, Die Cast

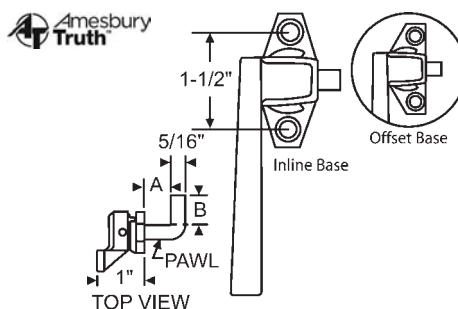

Part #	Finish	A	B	Base Type	Hand
32-329-8	Chestnut Bronze	7/16"	7/32"	Offset	Shown
32-330-8	Chestnut Bronze	7/16"	7/32"	Offset	Opposite
32-334-8	Chestnut Bronze	33/64"	11/32"	Offset	Opposite
32-335-8	Chestnut Bronze	7/16"	7/32"	In-line	Shown
32-335-7	Aluminum	7/16"	7/32"	In-line	Shown
32-336-7	Aluminum	7/16"	7/32"	In-line	Opposite
32-337-7	Aluminum	1/2"	7/32"	In-line	Shown
32-337-8	Chestnut Bronze	1/2"	7/32"	In-line	Shown
32-338-8	Chestnut Bronze	1/2"	7/32"	In-line	Opposite
32-339-8	Chestnut Bronze	33/64"	11/32"	In-line	Shown
32-351-3	White	7/8"	5/8"	In-line	Shown

Die Cast

## CASEMENT HANDLES

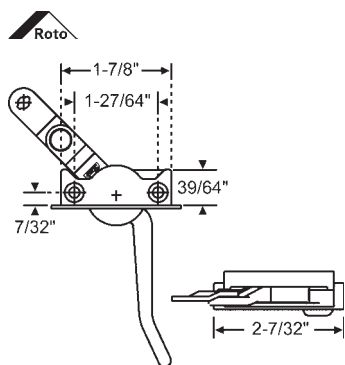

Part #	Hand	Color
34-184RHEW	Shown	European White
34-184LHEW	Opposite	European White

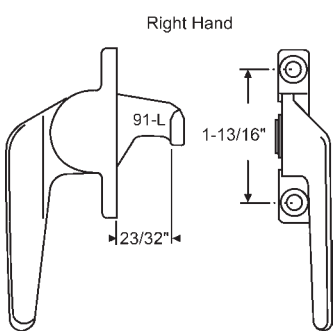

Part #	Hand	Finish
34-61	Opposite	Light Bronze
34-62	Shown	Light Bronze

Used with 50-717 Keeper

**HOPE'S**

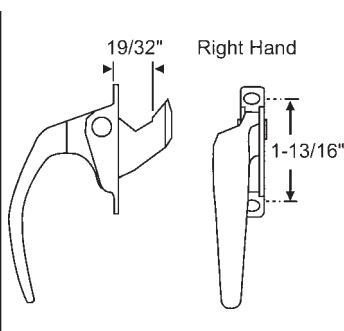

Part #	Hand	Finish
34-74	Shown	Bronze
34-75	Opposite	Bronze

**HOPE'S**

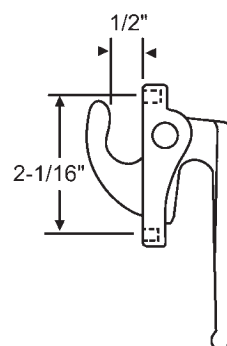

Part #	Finish
34-68	White Bronze

# WINDOW REPLACEMENT HARDWARE

## CASEMENT HANDLES

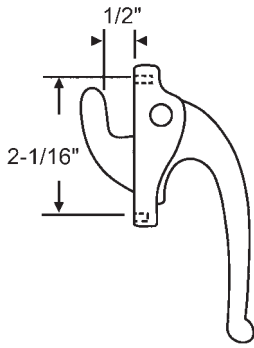

Part #	Finish
34-53	Dark Bronze

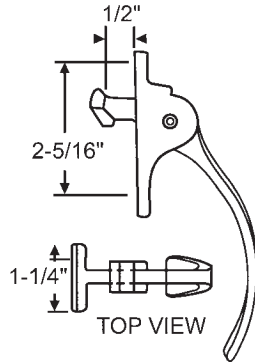

Part #	Finish
34-67DC	Light Bronze

Die Cast. Double Locking  
Used with 50-717 Keeper

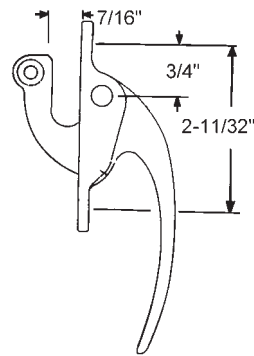

Part #	Finish
900-8977	White Bronze

Lower Casement Handle

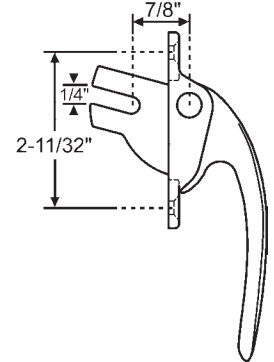

**34-178**  
White Bronze  
Euro Groove  
**TRACO/KAWNEER**

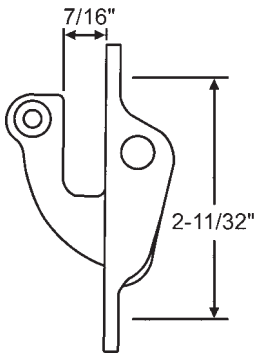

Part #	Finish
900-14118	White Bronze

Upper Locking Cam

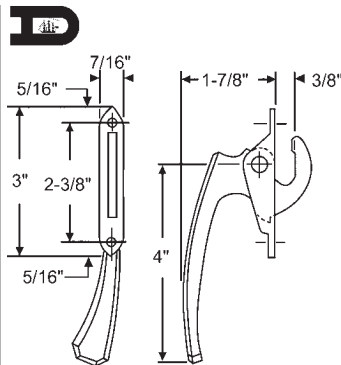

Part #	Hand	Finish
34-54	Shown	Bronze
34-55	Opposite	Bronze
34-54LB	Shown	Light Bronze
34-55LB	Opposite	Light Bronze
34-56	Shown	Aluminum
34-57	Opposite	Aluminum

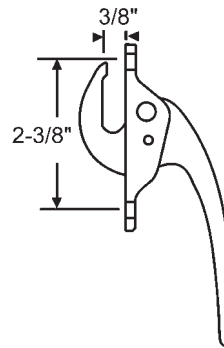

Part #	Finish
34-58	Gray
34-58B	Bronze
34-58W	White

Straight Handle. Die Cast.

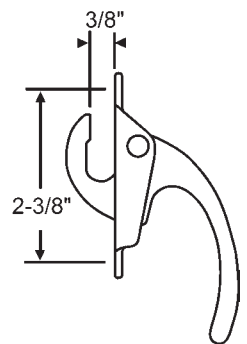

Part #	Finish
34-70	Brown

Die Cast

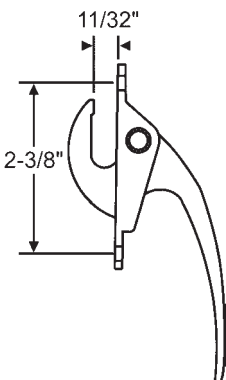

Part #	Finish
34-76	Dark Bronze

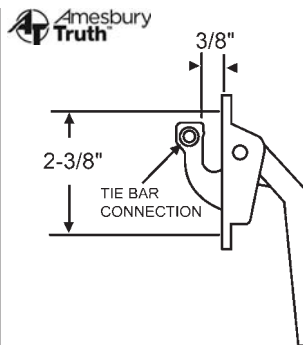

Part #	Finish
34-82-3	White
34-82-7	Aluminum
34-82-8	Chestnut Bronze

Dual Locking Handle. Die Cast

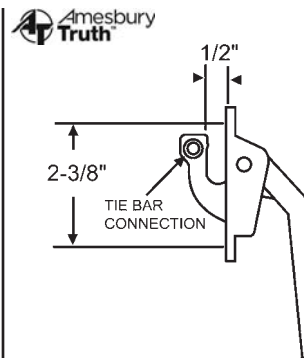

Part #	Finish
34-84-3	White
34-84-8	Chestnut Bronze
34-84-7	Aluminum
34-84-13	Brushed Copper Nickel

Dual Locking Handle. Die Cast

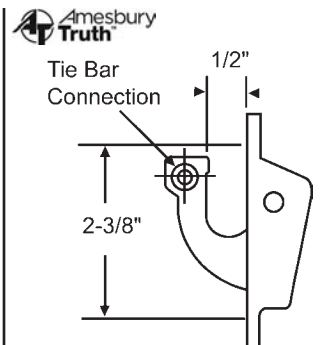

Part #	Finish
34-85-3	White
34-85-7	Aluminum
34-85-8	Chestnut Bronze
34-85-10	Black

Upper Locking Cam. Die Cast

# WINDOW REPLACEMENT HARDWARE

## CASEMENT HANDLES

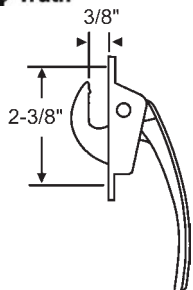

Part #	Finish
34-80-3	White
34-80-8	Chestnut Bronze
34-80-7	Aluminum
34-80-12	Medium Bronze

Die Cast

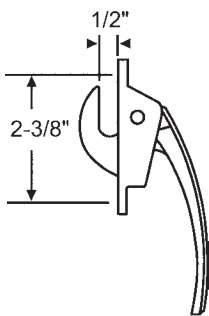

Part #	Finish
34-81-3	White
34-81-8	Chestnut Bronze

Die Cast

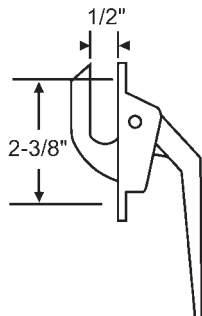

Part #	Finish
34-91-3	White

Die Cast

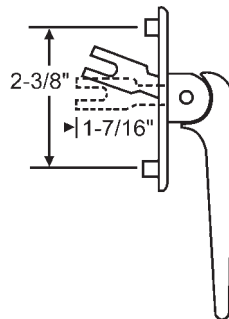

Part #	Finish
34-3	White

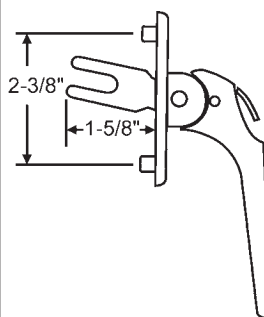

Part #	Finish
850-8782531	White
850-8782523	Brown

Die Cast

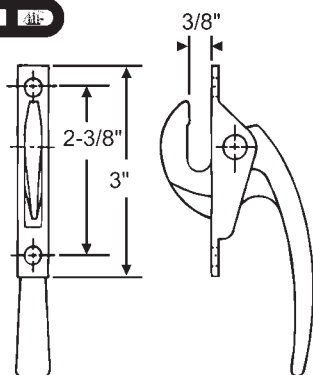

Part #	Finish
34-71	Light Bronze

Die Cast  
Straight Handle

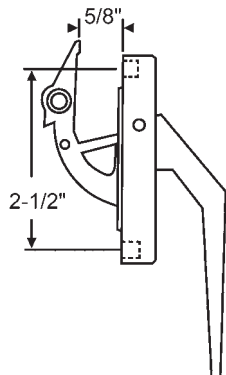

Part #	Finish
900-14723	Bronze

**ACORN**

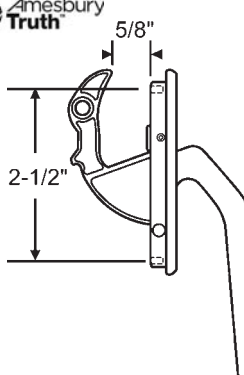

Part #	Finish
34-97-1	Bronze
34-97-29	Bright White

Die Cast Lock Bar

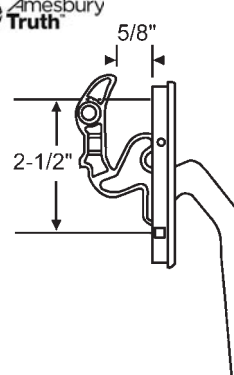

Part #	Finish
34-95-1	Bronze
34-95-3	White
34-95-8	Chestnut Bronze
34-95-9	Beige
34-95-7	Aluminum

Die Cast Lock Bar

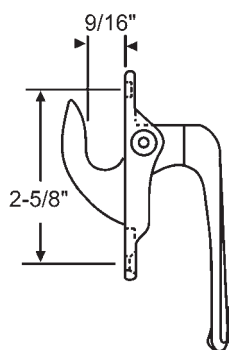

Part #	Hand	Finish
34-51	Shown	White Bronze
34-50	Opposite	White Bronze

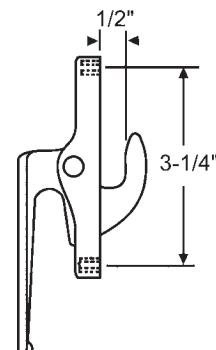

Part #	Finish
34-52	Dark Bronze

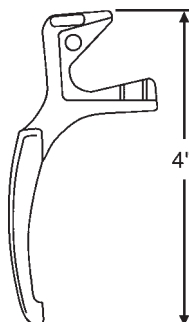

Part #	Hand	Color
34-113	Shown	White
34-112	Opposite	White
34-111	Shown	Brass
34-110	Opposite	Brass
34-115	Shown	Champagne
34-114	Opposite	Champagne

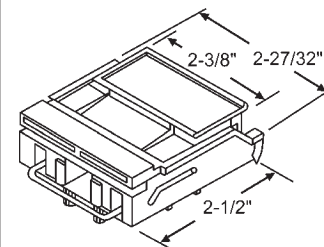

Part #	Finish
900-12199	Driftwood
900-12199W	White

**PEACHTREE**

# WINDOW REPLACEMENT HARDWARE

## CASEMENT HANDLES

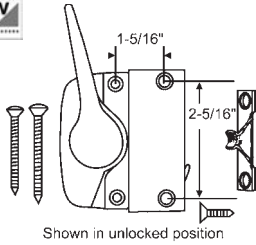

Shown in unlocked position

Part #	Hand	Finish
750-0531708	Shown	Bronze
750-0531712	Opposite	Bronze

Replaces Andersen numbers  
0533508/0533512, 0533509/0533513  
and 0533608/0533612

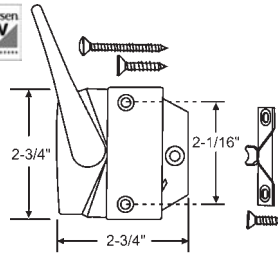

Shown in unlocked position

Part #	Hand	Finish
750-1351408	Shown	Stone
750-1351410	Opposite	Stone
750-1351420	Shown	White
750-1351422	Opposite	White

Replaces Andersen numbers  
0565708/0565712

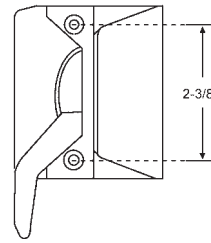

Part #	Hand	Finish
34-42-1	Shown	Bronze
34-43-1	Opposite	Bronze
34-42-3	Shown	White
34-43-3	Opposite	White
34-42-87	Shown	Gold
34-43-87	Opposite	Gold

Die Cast

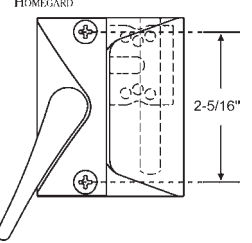

Part #	Finish
34-102-1	Bronze
34-102-3	White
34-102-5	Bright Brass

Primary Lock. Non-Handed. Die Cast

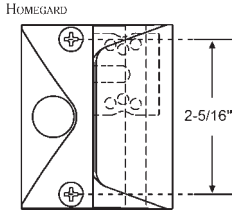

Part #	Finish
34-103-1	Bronze
34-103-3	White
34-103-5	Bright Brass

Secondary Lock. Non-Handed, Die Cast

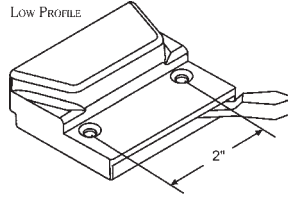

Part #	Finish
34-47-1	Bronze
34-47-3	White
34-47-9	Beige

Non-Handed. Die Cast

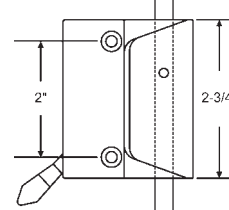

Part #	Finish
34-46-1	Bronze
34-46-3	White
34-46-29	Bright White

Non-Handed; for tandem application with  
use of tie bar (hole drilled through bottom  
gear piece). Die Cast

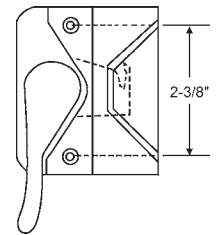

Part #	Hand	Finish
34-64-1	Opposite	Bronze
34-64-2	Opposite	Gold
34-63-3	Shown	White

Die Cast

## MULTI-POINT LOCKS

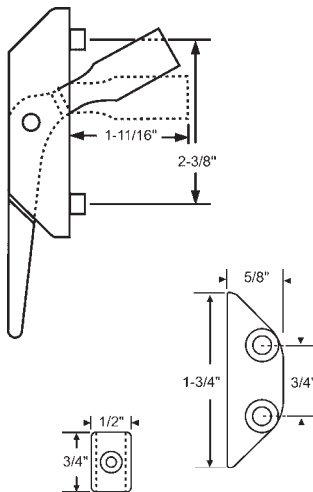

Part #	Finish	Description
34-159	White	Handle
39-610	White	Keeper
39-611	White	Slider Block

SILVERLINE

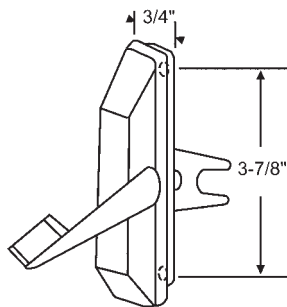

Part #	Finish
34-126BG	Beige
34-126EB	Earth Brown

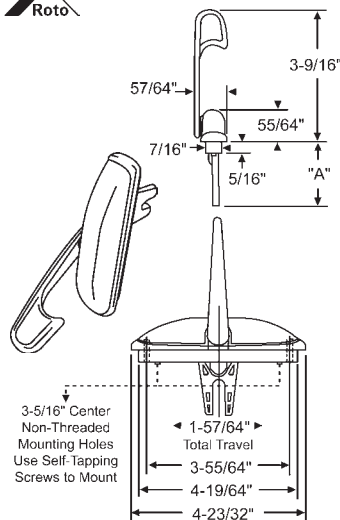

Part #	"A"	Finish
34-165-29W	1-9/64" (29mm)	White
34-165-29SV	1-9/64" (29mm)	Silver
34-165-37W	1-29/64" (37mm)	White

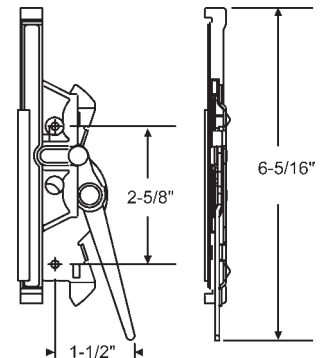

34-169

Encore Lock Drive Assembly

# WINDOW REPLACEMENT HARDWARE

## MULTI-POINT LOCKS

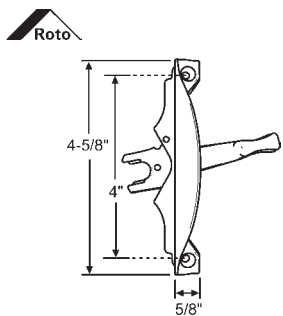

Part #	Hand
39-604CHP	Champagne

Handle & Escutcheon Kit

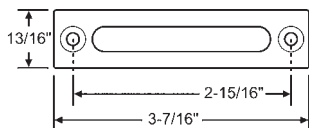

**39-603W**

Plastic Guide Housing, White

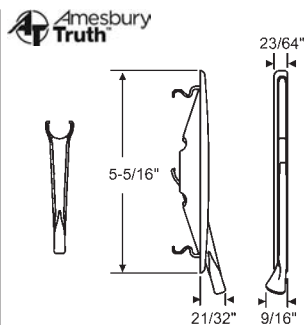

**34-170-3**

Encore Handle & Escutcheon  
White

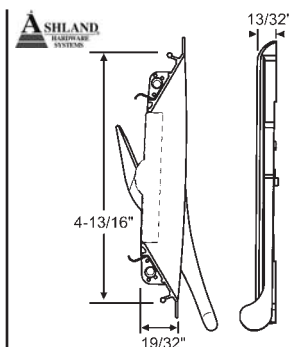

Part #	Finish
34-179BP	Brass Plated
34-179BZ	Bronze
34-179W	White

Casement Handle & Bezel

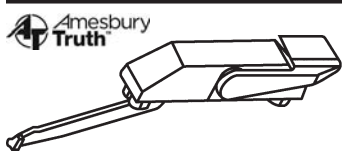

Part #	Hand	Finish
34-100-15NEG	Shown	Non E-Gard, Off White
34-99-15NEG	Opposite	Non E-Gard, Off White
34-100-1	Shown	Bronze
34-100-1NEG	Shown	Non E-Gard, Bronze
34-99-1	Opposite	Bronze
34-99-1NEG	Opposite	Non E-Gard, Bronze
34-100-3	Shown	White
34-99-3	Opposite	White
34-100-8	Shown	Chestnut Bronze
34-99-8	Opposite	Chestnut Bronze
34-100-29	Shown	Bright White
34-99-29	Opposite	Bright White
34-99-9	Opposite	Beige

Used in Tie Bar Applications

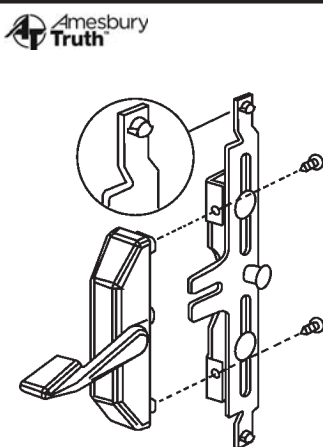

Part #	Hand	Finish
34-93-3	Shown	White
34-94-3	Opposite	White

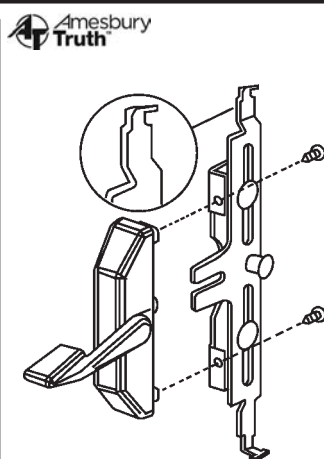

Part #	Hand	Finish
34-127-3	Shown	White
34-128-3	Opposite	White

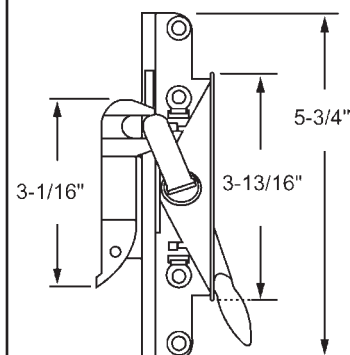

Part #	Hand	Finish
34-134-1	Shown	Bronze
34-135-1	Opposite	Bronze
34-134-15	Shown	Off White
34-135-15	Opposite	Off White

**MARVIN**

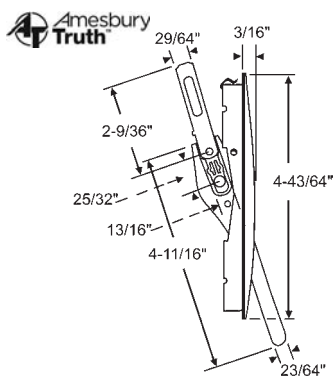

Part #	Hand	Finish
34-136-3	Shown	White
34-136-1	Shown	Bronze
34-136-4	Shown	Coppertone

Truth Mirage. Includes Locking Handle, Escutcheon and Backplate. Used with Keeper 50-883

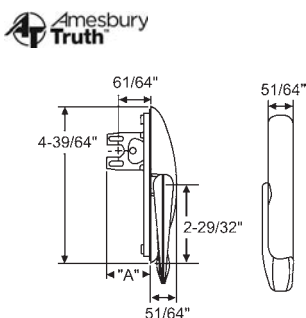

Part #	Finish	"A"
34-140-3G	White	1-25/64"
34-140-5G	Brass Plated	1-25/64"
34-144-3G	White	1-41/64"
34-144-9G	Beige	1-41/64"
34-141-3G	White	1-57/64"

Truth Maxim Lock with Gasket

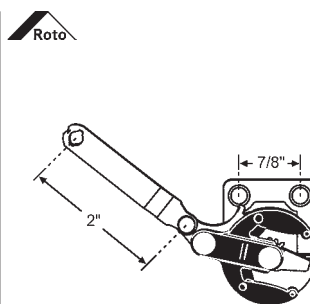

Part #	Hand
34-185RH	Shown
34-185LH	Opposite

Handle Mechanism

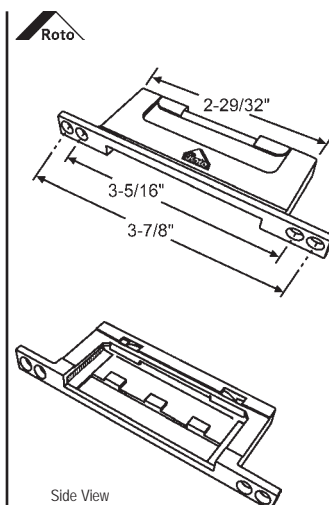

Side View

**40R-3**

Safety Lock Device. Zinc Die Cast



# WINDOW REPLACEMENT HARDWARE

## SPRING CATCHES

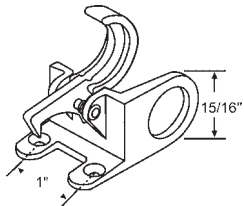

**900-18718**

Snap Lock with Pole Ring. White Bronze. Use Screw 20-447

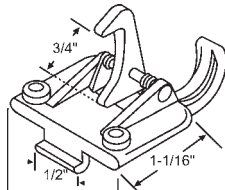

**32-393**

Lower Automatic Lock. White Bronze  
**SEASONALL**

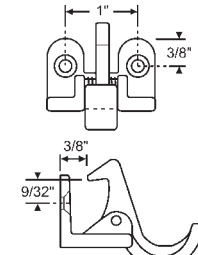

**32-395**

White Bronze

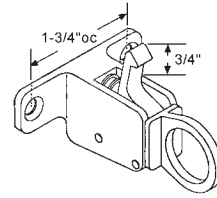

**900-20322**

White Bronze  
**SWS**

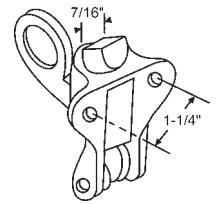

**32-280**

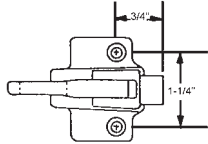

**900-11332**

White Bronze

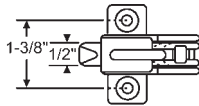

**900-16312**

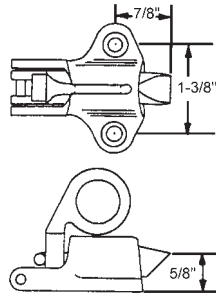

**900-9258**

White Bronze

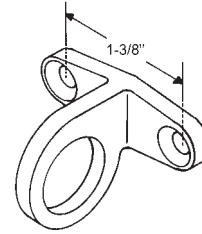

**900-8650**

Pole Ring  
White Bronze

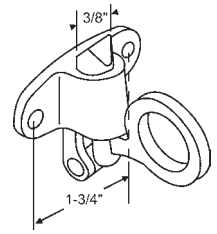

**32-277**

Aluminum Finish  
Use with 900-9107 Keeper.

## CUSTODIAL/VENT LOCKS

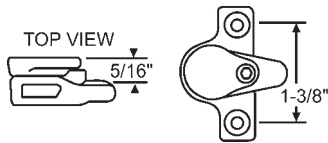

**32-256**

White Bronze Finish  
Use with 900-218 Key.

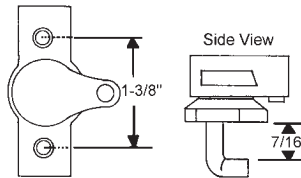

**900-13324**

White Bronze

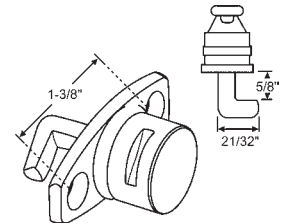

**32-603BZ**

Bronze

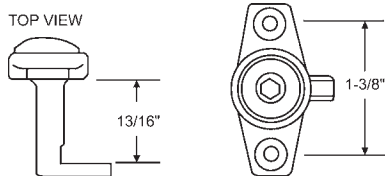

**32-284**

White Bronze. Use with 900-19637 Key.

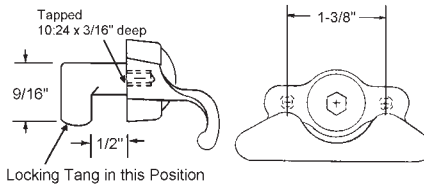

**900-11108**

White Bronze  
Use with 900-19637 Key.

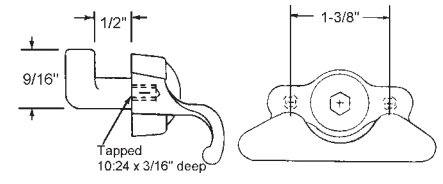

**900-1221**

White Bronze  
Use with 900-19637 Key.

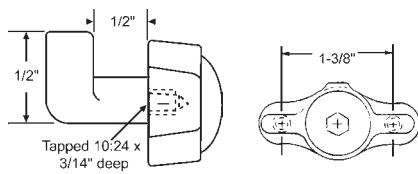

**900-7970**

White Bronze  
Use with 900-19637 Key.

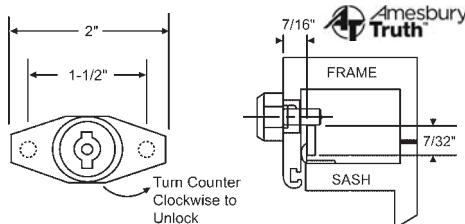

Part #	Finish
32-373-3	White
32-373-7	Aluminum
32-373-8	Chestnut Bronze

Use with 39-91 Key.

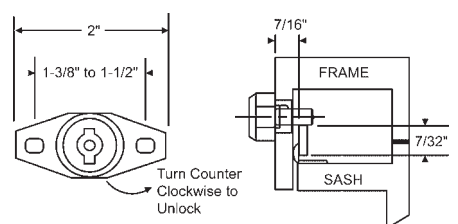
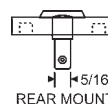

Part #	Finish
32-379-7	Aluminum
32-379-8	Chestnut Bronze

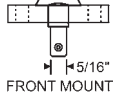

# WINDOW REPLACEMENT HARDWARE

## REMOVABLE HANDLE KEYS

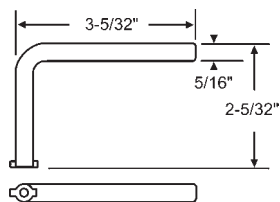

**39-91**

Custodial Lock Handle Key

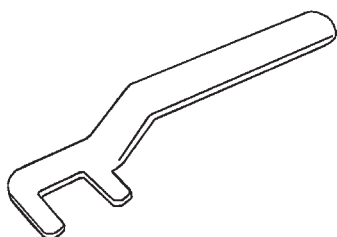

**39-90**

Spanner Tool for Truth Die Cast Locks

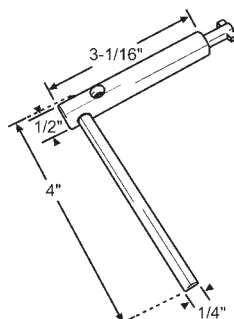

**39-942**

Custodial Lock Handle Key, Black



**900-21413**

Handle Cam Wrench with 1/8" Hex



**900-11209**

Handle Cam Wrench with 5/32" Hex

**EFCO/GRAHAM/KAWNEER**

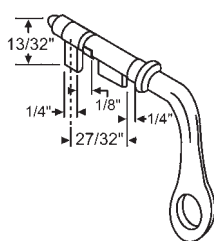

**900-10521**

Window Key

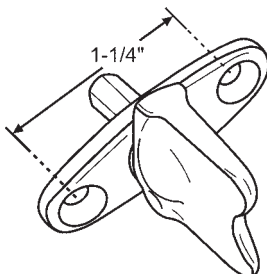

**900-21510**

AC Key with 7/32" Hex

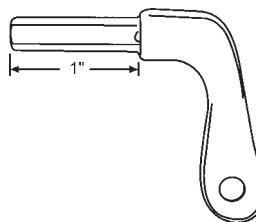

**900-19637**

1/4" Hex

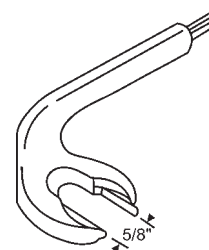

**900-218**

Hex fits 5/32" Allen Set Screw for bronze handles.

## PROJECT IN, PROJECT OUT, & CASEMENT KEEPERS & STRIKES

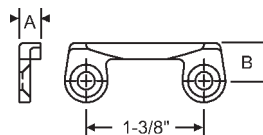

Part #	A	B
50-1107	7/16"	3/8"
900-9131	11/32"	7/16"
50-664	7/16"	7/16"
900-7262	1/4"	7/16"
900-11816	11/32"	5/16"

These standard keepers are typically concealed in the frame. They are designed to work with the 156 and 158 series handles and come in many varieties to fit your specific profile. White Bronze

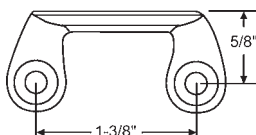

**50-668**

White Bronze

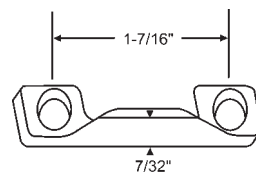

**50-693**

White Bronze

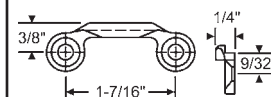

**900-22624**

This Keeper features an edge designed to fit over a rib on and extruded frame.

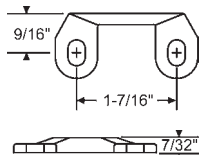

**900-21734**

This keeper features slotted mounting holes to allow the fit to be adjusted on sight to maximize the window compression for optimal performance. White Bronze

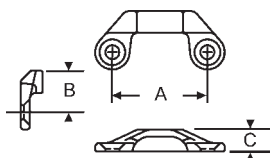

Part #	A	B	C
50-665	1-3/8"	1/2"	5/32"
50-674	1-3/8"	1/2"	3/16"
50-244WBZ	1-3/8"	7/16"	5/16"
50-666	1-3/8"	13/32"	1/4"
50-683	1-3/8"	13/32"	9/32"
50-728	1-3/8"	19/32"	5/16"
50-928	1-1/2"	15/32"	3/16"
50-667	1-3/8"		11/64"

This popular strike design keeps the mounting holes away from the locking surface to allow the strike pad to be placed as close to the edge of the frame as possible. White Bronze

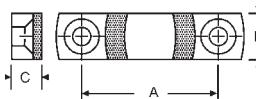

Part #	A	B	C
50-1079	1-3/8"	1/2"	11/64"
900-18263	1-1/2"	1/2"	21/64"
900-19827	1-1/2"	7/16"	7/32"
50-1302WBZ	1-1/2"	7/16"	3/16"
50-695	1-7/16"	1/2"	3/16"

These simple flat strikes are perfect for installations that have narrow mounting conditions on the frame. White Bronze

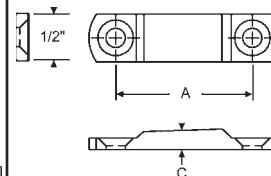

Part #	A	C
50-964	1-7/16"	9/64"
900-7861	1-7/16"	13/64"

These strikes feature an angled cam surface to gently engage the handle and compress the window seal. White Bronze

# WINDOW REPLACEMENT HARDWARE

## PROJECT IN, PROJECT OUT, & CASEMENT KEEPERS & STRIKES

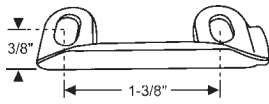

**900-22584**  
White Bronze

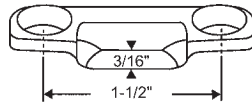

**900-12905**  
White Bronze Burnished

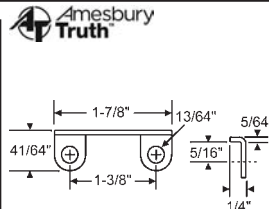

**50-406**  
Stainless Steel. Low Profile

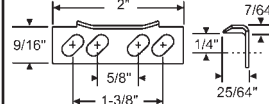

**50-408**  
Stainless Steel. Adjustable Keeper

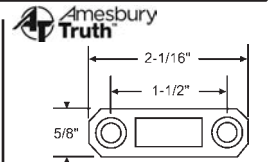

Part #	Finish
50-1251-1	Bronze
50-1251-3	White
50-1251-7	Aluminum
50-1251-8	Chestnut Bronze

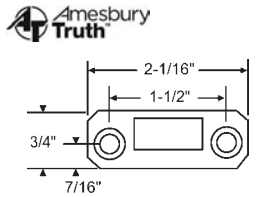

Part #	Finish
50-1252-3	White
50-1252-8	Chestnut Bronze
50-1252-12	Medium Bronze

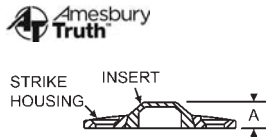

Part #	A
39-81-10	7/32"
39-82-10	9/32"
39-83-10	11/32"

Black Nylon Strike Insert.

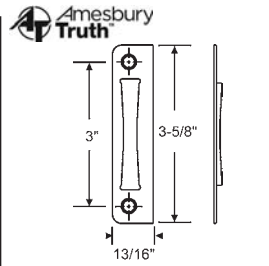

Part #	Finish
39-87-3	White
39-87-9	Beige

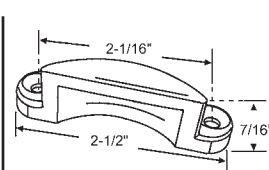

Part #	Finish
50-836OW	Off White

Plastic  
**KASSON/KELLER**

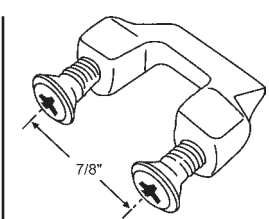

Part #	Finish
900-19680	White Bronze

**SEASONALL**

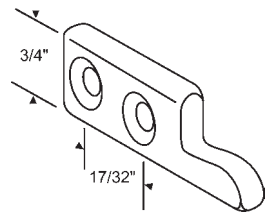

**50-717**  
Brass. Keeper for 34-67DC.

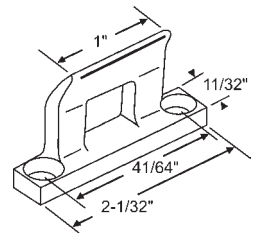

**900-9107**  
Zinc Die Cast. Keeper for 32-277

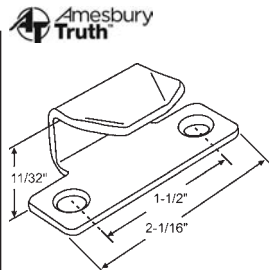

Part #	Finish
50-774-3	White
50-774-9	Beige

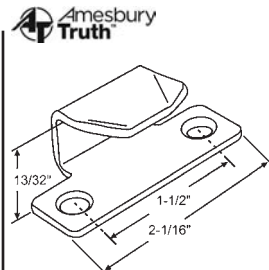

Part #	Finish
50-814-3	White
50-814-9	Beige

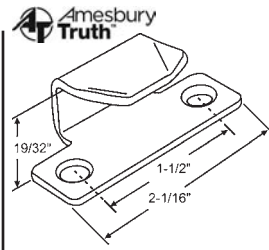

Part #	Finish
50-755-1	Bronze
50-755-3	White
50-755-14	Cocoa Brown

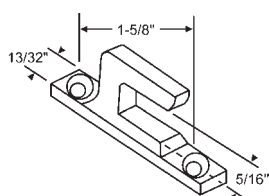

Part #	Finish
50-714	White

Hook Type. Used with 32-224,  
32-228, 32-229 Handles

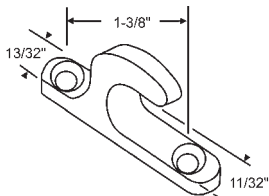

Part #	Finish
50-675	Dark Bronze

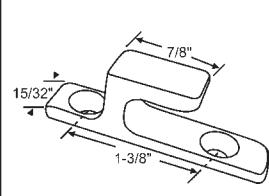

Part #	Finish
900-9761	White Bronze

Hook Type

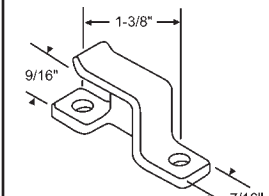

Part #	Finish
50-672	Dark Bronze

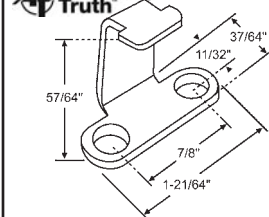

Part #	Finish
50-413	E-Gard Finish
50-759	Stainless Steel
50-739	High Strength

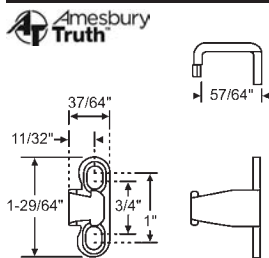

Part #	Finish
50-890	Steel

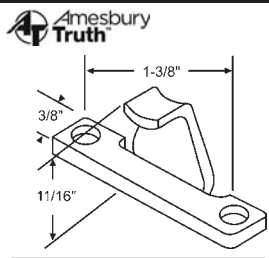

Part #	Finish
50-644	Steel

Use with 34-64, 34-63, 34-65, 34-66

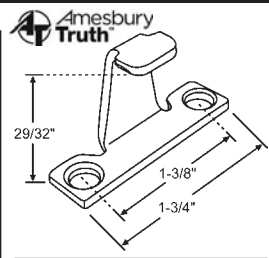

Part #	Finish
50-435	E-Gard
50-435CG	Coast Gard

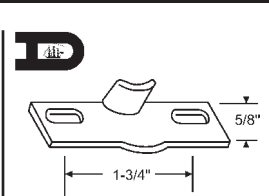

Part #	Finish
50-659	Aluminum

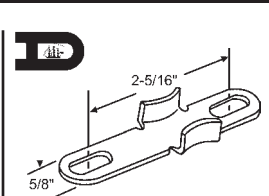

Part #	Finish
50-685A	Aluminum

# WINDOW REPLACEMENT HARDWARE

## PROJECT IN, PROJECT OUT, & CASEMENT KEEPERS

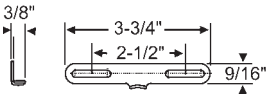

**39-202**  
Stainless Steel

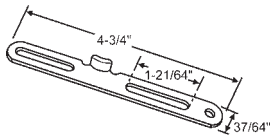

**39-920**  
Stainless Steel. 7/64" Thick  
**TRACO**

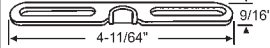

**900-20912**  
Dichromate  
**ACORN**

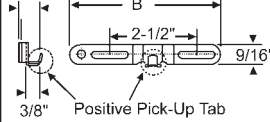

Part #	A	B
39-183	19/32"	4-19/32"
39-208	3/8"	4-47/64"
39-658	5/8"	3-43/64"

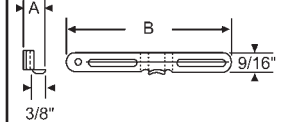

Part #	A	B
39-78	1/2"	4-41/64"
39-79	9/16"	4-19/32"

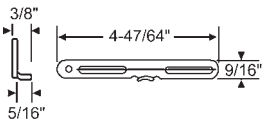

**39-77**  
Die Cast

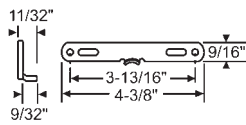

**39-729**  
Die Cast

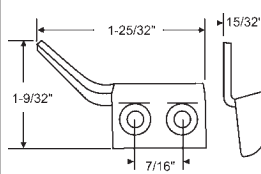

Part #	Hand
39-220	Shown
39-221	Opposite

Maxim Multipoint Lock Keeper.  
For Cone Roller System

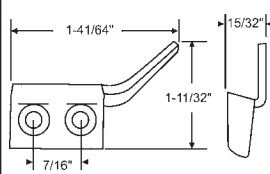

Part #	Hand
50-227	Shown
50-226	Opposite

Maxim Multipoint Lock Keeper.  
Used with Cone Tie Bars.

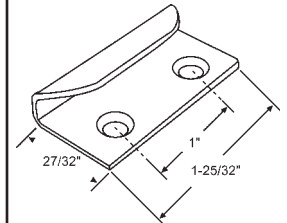

Part #	Finish
50-921	Beige

Zinc Die Cast. Maxim

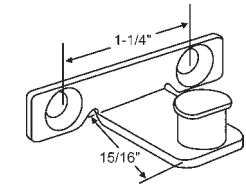

Part #	Finish
50-883	E-Gard Finish

Maxim. For Concealed Multipoint

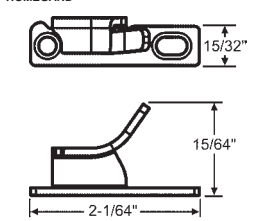

Part #	Hand	Finish
50-1117	Shown	E-Gard
50-1118	Opposite	E-Gard

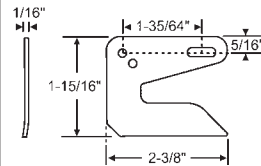

Part #	Hand
50-772	Shown
50-771	Opposite

For Interlock Roller System

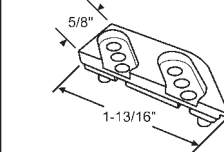

Part #	Hand
39-895	Shown
39-896	Opposite

White Nylon

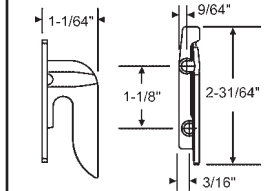

Part #	Hand
50-1115LH	Shown
50-1115RH	Opposite

Flange Keeper. Steel E-Gard

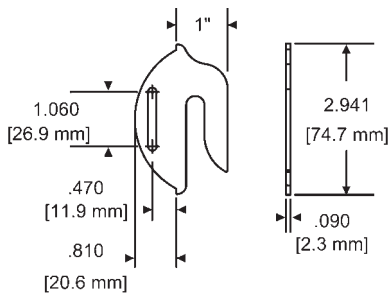

**50-1113**  
Biscuit Keeper  
Stainless Steel

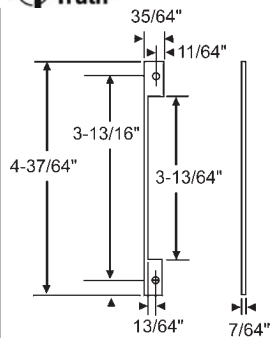

**34-145**  
Support Plate

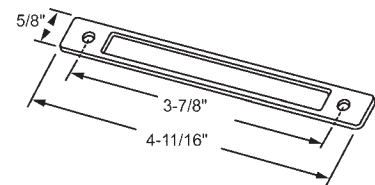

**34-153**  
Handle Plate Guide. White. Plastic

# WINDOW REPLACEMENT HARDWARE

## FACE MOUNTED CASEMENT OPERATORS

### TRUTH'S SINGLE ARM CASEMENT OPERATORS - FRONT MOUNT

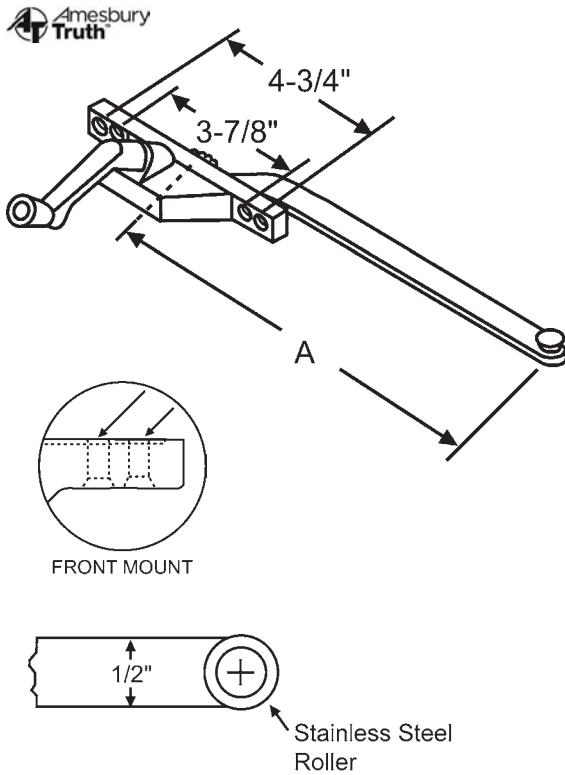

Part #	Hand	Arm Length ("A")	Finish	Roller
36-323-8	Shown	7-1/2"	Chestnut Bronze	Stainless Steel
36-324-8	Opposite	7-1/2"	Chestnut Bronze	Stainless Steel
36-323-10	Shown	7-1/2"	Black	Stainless Steel
36-324-10	Opposite	7-1/2"	Black	Stainless Steel
36-433-1	Shown	9-1/2"	Bronze	Stainless Steel
36-434-1	Opposite	9-1/2"	Bronze	Stainless Steel
36-433-3	Shown	9-1/2"	White	Stainless Steel
36-434-3	Opposite	9-1/2"	White	Stainless Steel
36-433-8	Shown	9-1/2"	Chestnut Bronze	Stainless Steel
36-434-8	Opposite	9-1/2"	Chestnut Bronze	Stainless Steel
36-433-10	Shown	9-1/2"	Black	Stainless Steel
36-434-10	Opposite	9-1/2"	Black	Stainless Steel
36-431-1	Shown	13-1/2"	Bronze	Stainless Steel
36-432-1	Opposite	13-1/2"	Bronze	Stainless Steel
36-431-8	Shown	13-1/2"	Chestnut Bronze	Stainless Steel
36-432-8	Opposite	13-1/2"	Chestnut Bronze	Stainless Steel
36-431-10	Shown	13-1/2"	Black	Stainless Steel
36-432-10	Opposite	13-1/2"	Black	Stainless Steel

Handle sold separately. See Pages 214 - 218

### TRUTH'S SINGLE ARM CASEMENT OPERATORS - REAR MOUNT

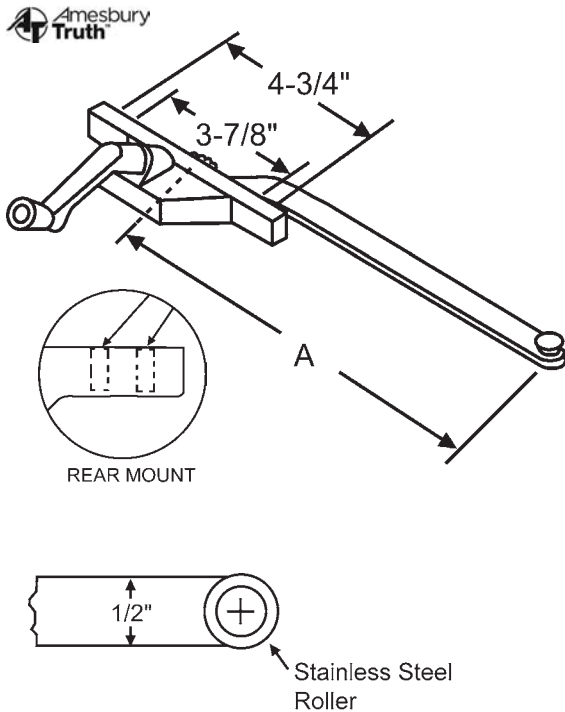

Part #	Hand	Arm Length ("A")	Finish	Roller
36-338-9	Shown	7-1/2"	Beige	Stainless Steel
36-339-9	Opposite	7-1/2"	Beige	Stainless Steel
36-338-10	Shown	7-1/2"	Black	Stainless Steel
36-339-10	Opposite	7-1/2"	Black	Stainless Steel
36-444-3	Shown	9-1/2"	White	Stainless Steel
36-445-3	Opposite	9-1/2"	White	Stainless Steel
36-444-8	Shown	9-1/2"	Chestnut Bronze	Stainless Steel
36-445-8	Opposite	9-1/2"	Chestnut Bronze	Stainless Steel
36-444-13	Shown	9-1/2"	Brush Copper Nickel	Stainless Steel
36-445-13	Opposite	9-1/2"	Brush Copper Nickel	Stainless Steel
36-439-1	Shown	13-1/2"	Bronze	Stainless Steel
36-440-1	Opposite	13-1/2"	Bronze	Stainless Steel
36-439-3	Shown	13-1/2"	White	Stainless Steel
36-440-3	Opposite	13-1/2"	White	Stainless Steel
36-439-7	Shown	13-1/2"	Aluminum	Stainless Steel
36-440-7	Opposite	13-1/2"	Aluminum	Stainless Steel
36-439-8	Shown	13-1/2"	Chestnut Bronze	Stainless Steel
36-440-8	Opposite	13-1/2"	Chestnut Bronze	Stainless Steel
36-439-10	Shown	13-1/2"	Black	Stainless Steel
36-440-10	Opposite	13-1/2"	Black	Stainless Steel
36-439-13	Shown	13-1/2"	Brush Copper Nickel	Stainless Steel
36-440-13	Opposite	13-1/2"	Brush Copper Nickel	Stainless Steel

Handle sold separately. See Pages 214 - 218

# WINDOW REPLACEMENT HARDWARE

## FACE MOUNTED CASEMENT OPERATORS

### TRUTH'S SINGLE ARM CASEMENT OPERATORS - FRONT & REAR MOUNT

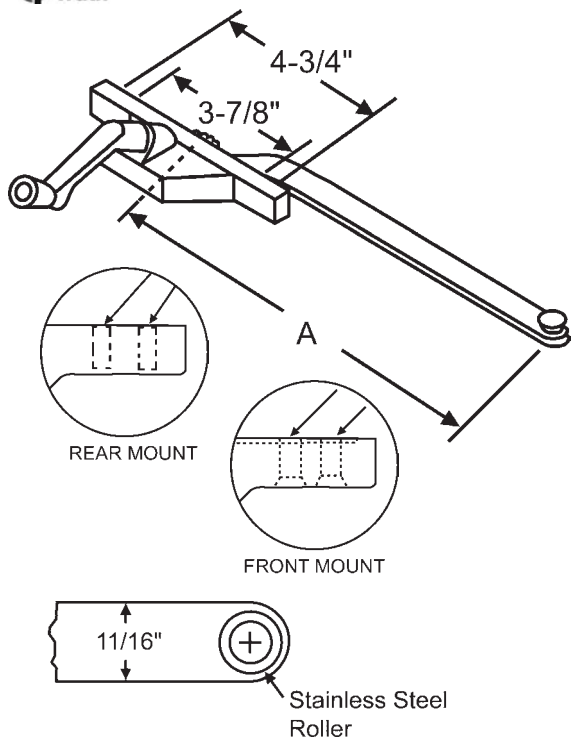

Part #	Hand	Mounting	Arm Length ("A")	Finish
36-230-8	Shown	Front	6"	Chestnut Bronze
36-231-8	Opposite	Front	6"	Chestnut Bronze
36-220-3	Shown	Front	9"	White
36-221-3	Opposite	Front	9"	White
36-220-7	Shown	Front	9"	Aluminum
36-221-7	Opposite	Front	9"	Aluminum
36-220-8	Shown	Front	9"	Chestnut Bronze
36-221-8	Opposite	Front	9"	Chestnut Bronze
36-222-1	Shown	Front	11"	Bronze
36-223-1	Opposite	Front	11"	Bronze
36-222-3	Shown	Front	11"	White
36-223-3	Opposite	Front	11"	White
36-222-6	Shown	Front	11"	Clay
36-223-6	Opposite	Front	11"	Clay
36-222-7	Shown	Front	11"	Aluminum
36-223-7	Opposite	Front	11"	Aluminum
36-222-8	Shown	Front	11"	Chestnut Bronze
36-223-8	Opposite	Front	11"	Chestnut Bronze
36-223-10	Opposite	Front	11"	Black
36-224-3	Shown	Rear	9"	White
36-225-3	Opposite	Rear	9"	White
36-224-13	Shown	Rear	9"	Brushed Copper Nickel
36-225-13	Opposite	Rear	9"	Brushed Copper Nickel
36-226-3	Shown	Rear	11"	White
36-227-3	Opposite	Rear	11"	White
36-226-8	Shown	Rear	11"	Chestnut Bronze
36-227-8	Opposite	Rear	11"	Chestnut Bronze
36-226-10	Shown	Rear	11"	Black
36-227-10	Opposite	Rear	11"	Black

Handle sold separately. See Pages 214 - 218

### TRUTH'S REAR MOUNT DYAD CASEMENT OPERATORS

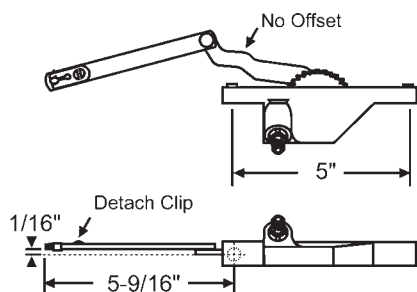

Part #	Hand	Finish
36-240-3	Shown	White
36-241-3	Opposite	White
36-241-6	Opposite	Clay
36-240-10	Shown	Black
36-241-10	Opposite	Black

Handle sold separately. See Pages 214 - 218  
Note: Detached clips can be reversed in the field.

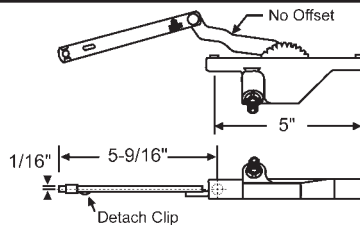

Part #	Hand	Finish
36-244-1	Shown	Bronze
36-245-1	Opposite	Bronze
36-244-3	Shown	White
36-245-3	Opposite	White
36-244-8	Shown	Chestnut Bronze
36-245-8	Opposite	Chestnut Bronze
36-244-8NEG	Shown	Chestnut Bronze (Non E-Gard)
36-245-8NEG	Opposite	Chestnut Bronze (Non E-Gard)
36-244-14	Shown	Cocoa Brown
36-245-14	Opposite	Cocoa Brown
36-244-14NEG	Shown	Cocoa Brown (Non E-Gard)
36-245-14NEG	Opposite	Cocoa Brown (Non E-Gard)
36-244-29	Shown	Bright White
36-245-29	Opposite	Bright White
36-244-29NEG	Shown	Bright White (Non E-Gard)
36-245-29NEG	Opposite	Bright White (Non E-Gard)

Handle sold separately. See Pages 214 - 218  
Note: Detached clips can be reversed in the field.

# WINDOW REPLACEMENT HARDWARE

## FACE MOUNTED CASEMENT OPERATORS

### TRUTH'S REAR MOUNT DYAD CASEMENT OPERATORS

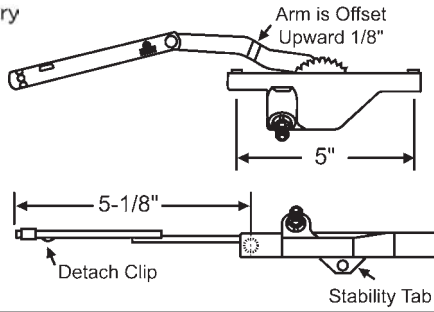

Part #	Hand	Finish
36-280-1	Shown	Bronze
36-281-1	Opposite	Bronze
36-280-9	Shown	Beige
36-281-9	Opposite	Beige
36-280-29	Shown	Bright White
36-281-29	Opposite	Bright White

Handle sold separately. See Pages 214 - 218  
Note: Detached clips can be reversed in the field.

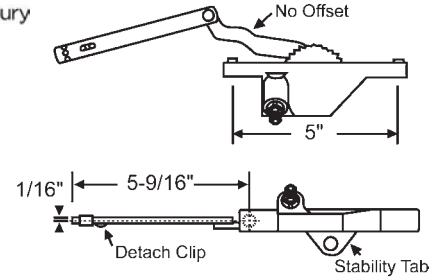

Part #	Hand	Finish
36-264-3	Shown	White
36-265-3	Opposite	White
36-264-9	Shown	Beige
36-265-9	Opposite	Beige
36-264-9CG	Shown	Coast-Gard
36-265-9CG	Opposite	Coast-Gard
36-264-29	Shown	Bright White
36-265-29	Opposite	Bright White

Handle sold separately. See Pages 214 - 218  
Note: Detached clips can be reversed in the field.

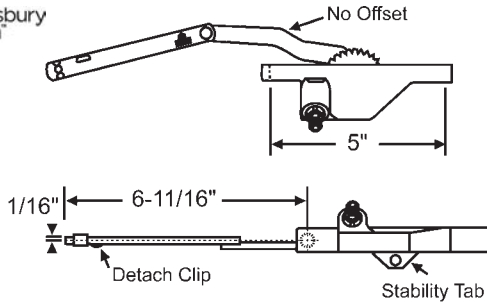

Part #	Hand	Finish
36-274-3	Shown	White
36-275-3	Opposite	White
36-274-6NEG	Shown	Clay
36-275-6NEG	Opposite	Clay
36-274-9	Shown	Beige
36-275-9	Opposite	Beige

Handle sold separately. See Pages 214 - 218  
Note: Detached clips can be reversed in the field.

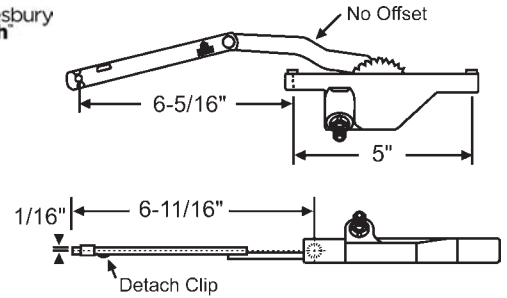

Part #	Hand	Finish
36-254-3	Shown	White
36-255-3	Opposite	White
36-254-6	Shown	Clay
36-255-6	Opposite	Clay
36-254-1	Shown	Bronze
36-255-1	Opposite	Bronze

Handle sold separately. See Pages 214 - 218  
Note: Detached clips can be reversed in the field.

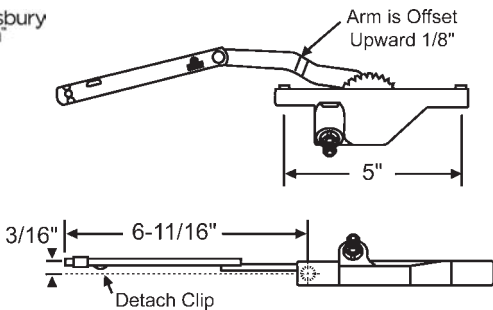

Part #	Hand	Finish
36-256-8	Shown	Chestnut Bronze
36-257-8	Opposite	Chestnut Bronze
36-256-4	Shown	Coppertone
36-257-4	Opposite	Coppertone

Handle sold separately. See Pages 214 - 218  
Note: Detached clips can be reversed in the field.

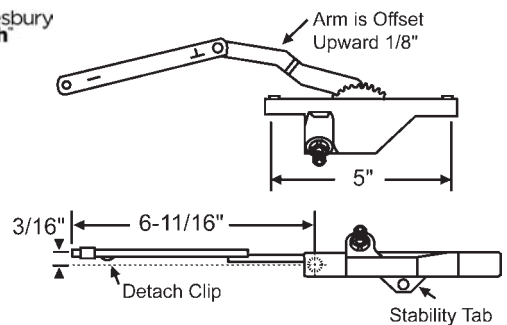

Part #	Hand	Finish
36-276-3	Shown	White
36-277-3	Opposite	White

Handle sold separately. See Pages 214 - 218  
Note: Detached clips can be reversed in the field.

# WINDOW REPLACEMENT HARDWARE

## FACE MOUNTED CASEMENT OPERATORS

### TRUTH'S REAR MOUNT DYAD CASEMENT OPERATORS

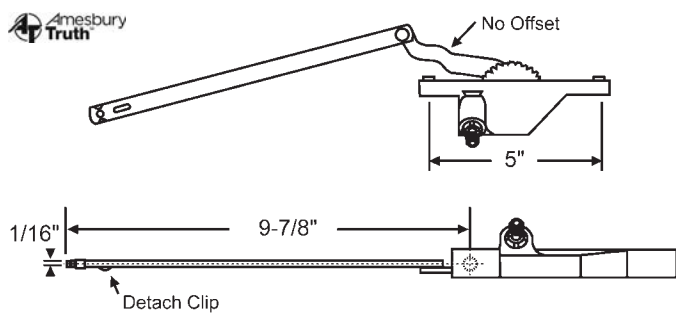

Part #	Hand	Finish
36-248-1	Shown	Bronze
36-249-1	Opposite	Bronze
36-248-3	Shown	White
36-249-3	Opposite	White

Handle sold separately. See Pages 214 - 218

Note: Detached clips can be reversed in the field.

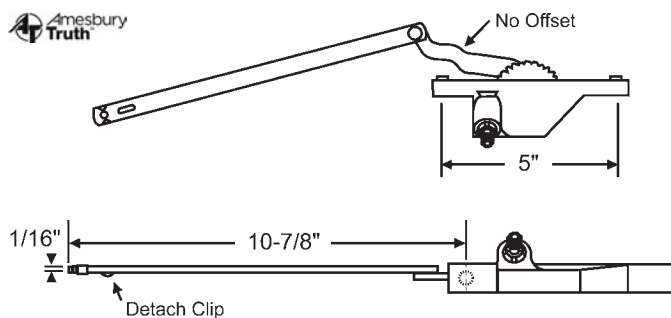

Part #	Hand	Finish
36-252-1	Shown	Bronze
36-253-1	Opposite	Bronze
36-252-3NEG	Shown	White
36-253-3NEG	Opposite	White

Handle sold separately. See Pages 214 - 218

Note: Detached clips can be reversed in the field.

## FACE MOUNTED CASEMENT OPERATORS

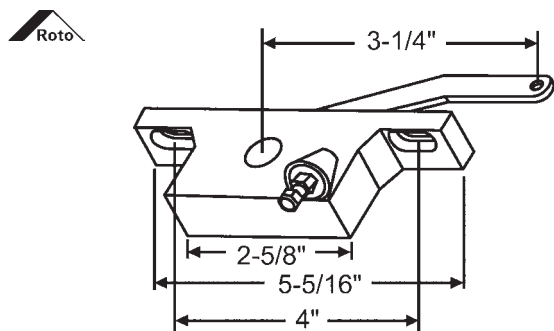

No Longer Available

Handle Sold Separately. See 37-159 or 37-159W on Page 215.

Some Covers are Available. See Page 214

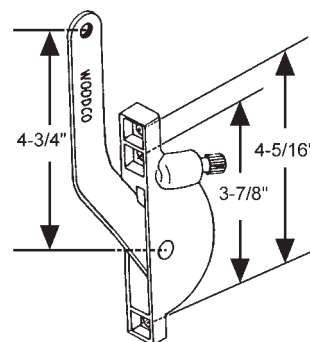

Part #	Description	Finish
900-14122	Flat Arm (shown)	Aluminum

Handle Included  
**WOODCO**

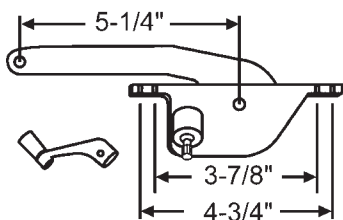

Part #	Hand	Finish	"T" Handles	Handle Only
36-138	Shown	Bronze	37-106B	37-111
36-139	Opposite	Bronze	37-106B	37-111
36-140	Shown	Aluminum	37-106	37-112
36-141	Opposite	Aluminum	37-106	37-112

Handle Included. Hand knobs use 5/16" size only.

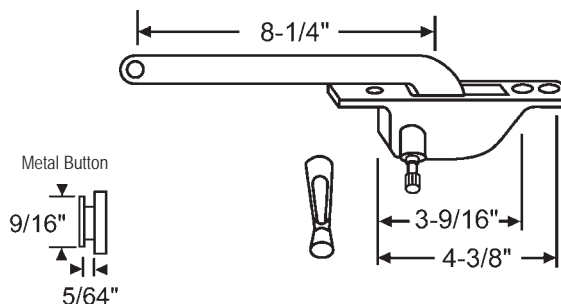

Part #	Hand	Finish	"T" Handles	Handle Only
36-134	Shown	Brown	37-106BR	37-111
36-135	Opposite	Brown	37-106BR	37-111

Die Cast - Handle Included  
**THORN/DORCHESTER**



# WINDOW REPLACEMENT HARDWARE

## FACE MOUNTED CASEMENT OPERATORS

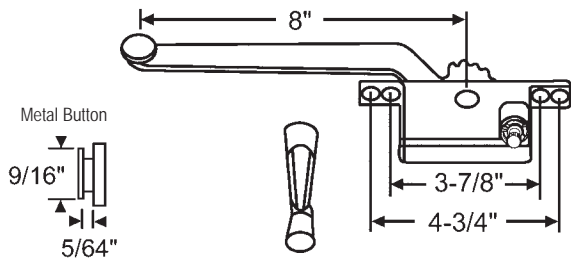

Part #	Hand	Finish	"T" Handles	Handle Only
36-110	Shown	Aluminum	37-113	37-100
36-104	Opposite	Aluminum	37-113	37-100
36-111	Shown	Brown	37-113B	37-101
36-109	Opposite	Brown	37-113B	37-101

Handle Included

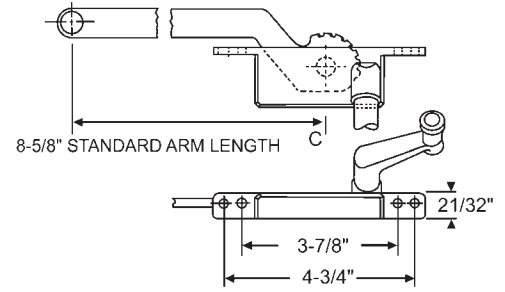

Part #	Hand	Finish
36-143	Opposite	Light Bronze
36-142	Shown	Light Bronze
36-143AL	Opposite	Aluminum
36-142AL	Shown	Aluminum

Handle Included.  
**DORCHESTER**

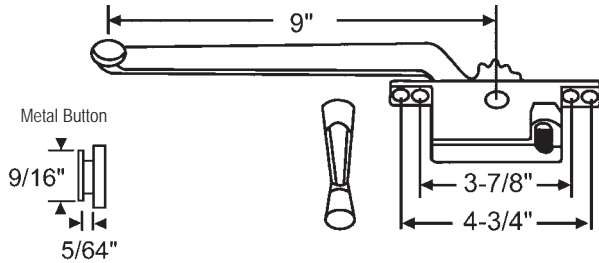

Part #	Hand	Finish	"T" Handles	Handle Only
36-114	Shown	Aluminum	37-113	37-100
36-112	Opposite	Aluminum	37-113	37-100
36-114W	Shown	White	37-113W	37-100W
36-112W	Opposite	White	37-113W	37-100W
36-115	Shown	Brown	37-113B	37-101
36-113	Opposite	Brown	37-113B	37-101

Die Cast - Handle Included. Hand knobs use 3/8" size only.

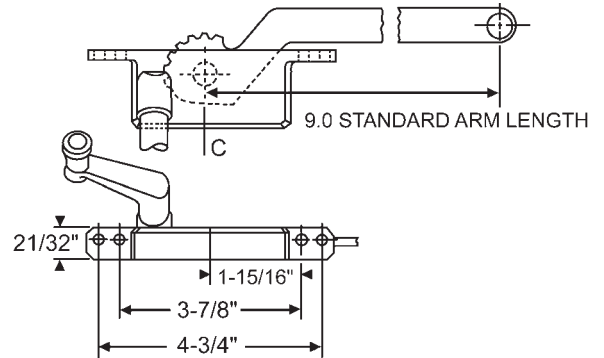

Part #	Hand	Finish	Package
36-143-9	Shown	Light Bronze	Bagged
36-142AL-9	Opposite	Aluminum	Bagged

Handle Included  
**DORCHESTER**

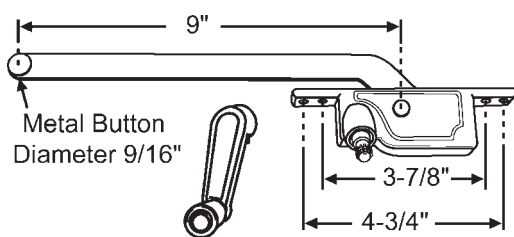

Part #	Hand	Finish
36-448	Shown	Aluminum
36-446	Opposite	Aluminum
36-449	Shown	WCM Bronze
36-447	Opposite	WCM Bronze

Handle Included

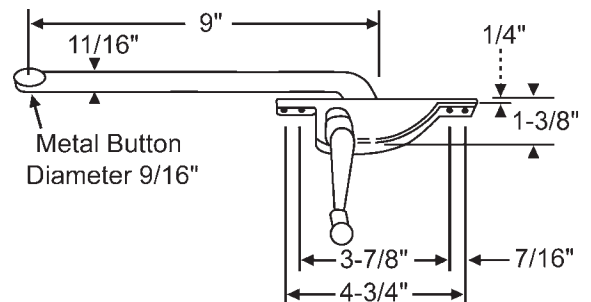

Part #	Hand	Finish
36-314	Shown	Aluminum
36-312	Opposite	Aluminum
36-313	Shown	Bronze
36-311	Opposite	Bronze

Handle Included

# WINDOW REPLACEMENT HARDWARE

## FACE MOUNTED CASEMENT OPERATORS

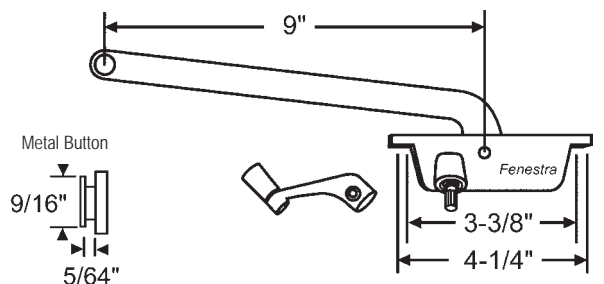

Part #	Hand	Finish
36-130	Shown	Aluminum
36-131	Opposite	Aluminum
36-130BZ	Shown	Bronze
36-131BZ	Opposite	Bronze

Handle Included

T-Handle Only: 37-106 (Aluminum); Additional Crank Handle: 37-112 (Aluminum)

**FENESTRA**

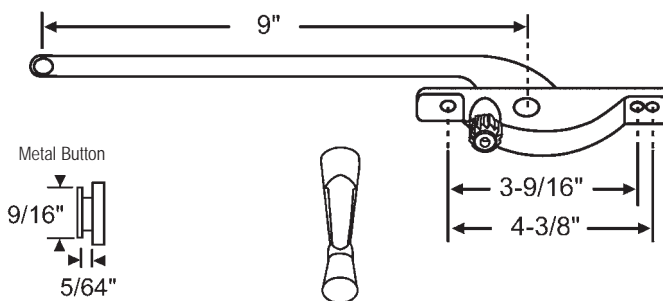

Part #	Hand	Finish	"T" Handles	Handle Only
36-102	Shown	Aluminum	37-106	37-112
36-100	Opposite	Aluminum	37-106	37-112
36-103	Shown	Brown	37-106BR	37-111
36-101	Opposite	Brown	37-106BR	37-111

Handle Included

**THORN**

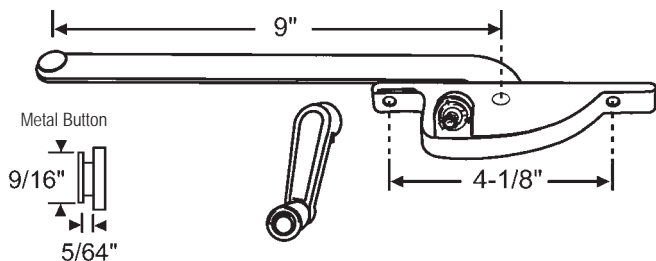

Part #	Hand	Finish	"T" Handles	Handle Only
36-118	Shown	Aluminum	37-106	37-112
36-116	Opposite	Aluminum	37-106	37-112
36-119B	Shown	Brown	37-106BR	37-111
36-117B	Opposite	Brown	37-106BR	37-111

Handle Included

**HOPE'S**

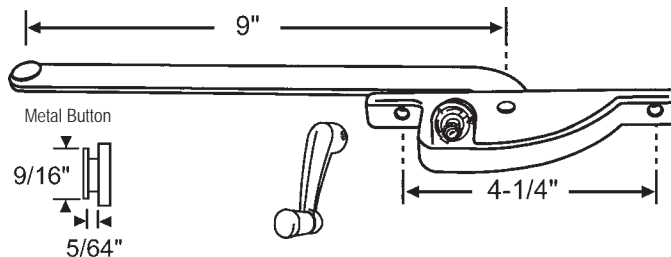

Part #	Hand	Finish	"T" Handles	Handle Only
36-107	Shown	Aluminum	37-106	37-112
36-105	Opposite	Aluminum	37-106	37-112
36-108	Shown	Brown	37-106BR	37-111
36-106	Opposite	Brown	37-106BR	37-111

Handle Included

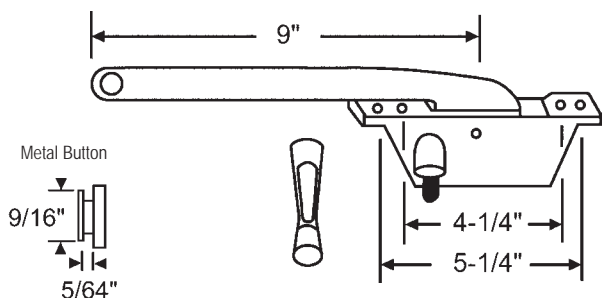

Part #	Hand	Finish	"T" Handles	Handle Only
36-136	Shown	Aluminum	37-106	37-112
36-137	Opposite	Aluminum	37-106	37-112
36-136BZ	Shown	Bronze	37-106BR	37-112DBZ
36-137BZ	Opposite	Bronze	37-106BR	37-112DBZ

Handle Included

Use with Casement Track 38-51.

**FENESTRA**

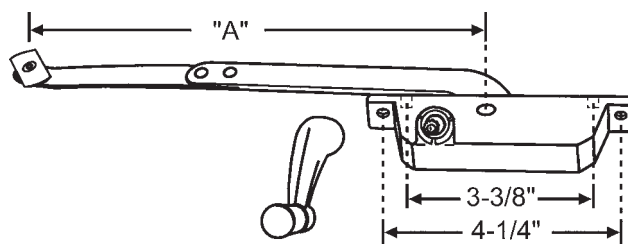

Part #	Hand	Finish	"A"
36-150-9	Shown	Aluminum	9"
36-151-9	Opposite	Aluminum	9"
36-150	Shown	Aluminum	13"
36-151	Opposite	Aluminum	13"

Handle Included. Hand knobs use 5/16" size only.

**FENESTRA**

# WINDOW REPLACEMENT HARDWARE

## FACE MOUNTED CASEMENT OPERATORS

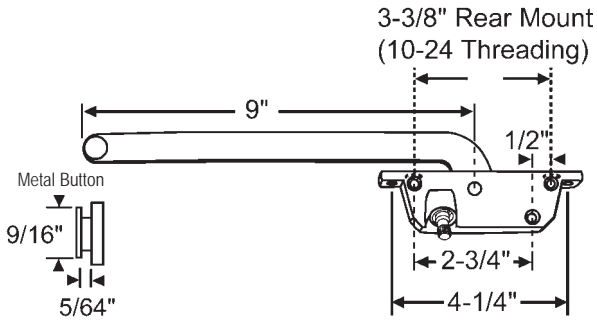

Part #	Hand	Finish
36-132	Shown	Brown
36-133	Opposite	Brown
36-132AL	Shown	Aluminum
36-133AL	Opposite	Aluminum

Die Cast - Handle Included

**FENESTRA**

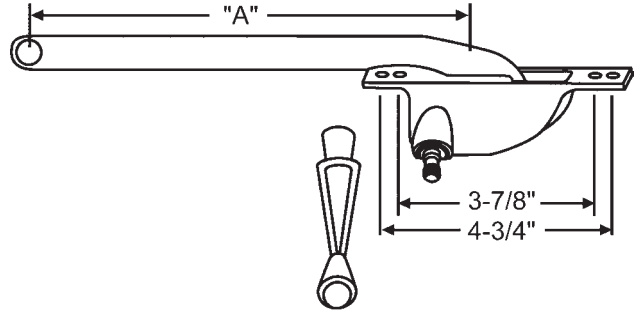

Part #	Hand	Finish	"A"
900-19855LH	Opposite	Aluminum	9"
900-19855RH	Shown	Aluminum	9"
900-13148LH	Opposite	Aluminum	11"
900-13148RH	Shown	Aluminum	11"

Intermediate Operator. Handle & Installation Screws #20-283 Included  
Hope 9003HD Replacement

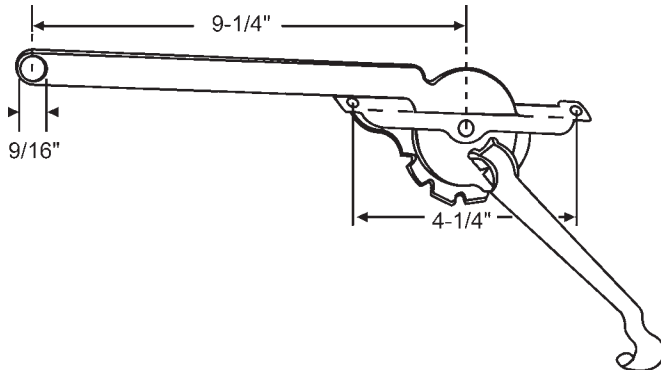

Part #	Hand	Finish	Handle Length
36-524RH-7SV	Shown	Silver	7"
36-524LH-7SV	Opposite	Silver	7"
36-524RH-9SV	Shown	Silver	9"
36-524LH-9SV	Opposite	Silver	9"

Lever Operator

**FENESTRA**

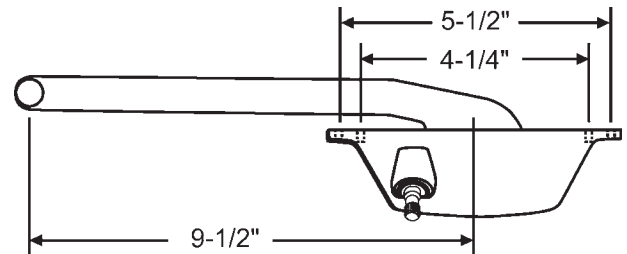

Part #	Hand	Finish
900-9653LH	Opposite	White Bronze
900-9653RH	Shown	White Bronze

Handle Included  
Polished Lacquered Finish

## GREENHOUSE OPERATORS

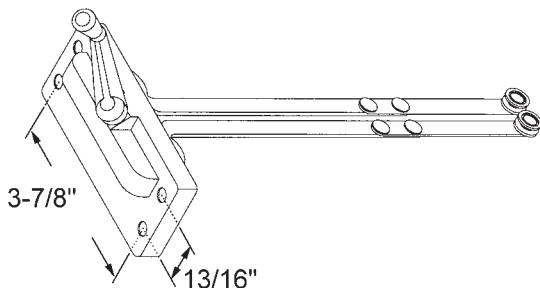

Part #	Finish
900-20115B	Bronze
900-20115W	White

4-Hole Greenhouse Operator with Handle

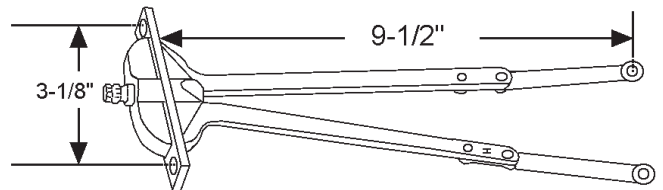

Part #	Finish
900-21266BK	Black

Handle Included  
2 Hole Greenhouse Operator

# WINDOW REPLACEMENT HARDWARE

## SILL MOUNTED CASEMENT OPERATORS

### TRUTH'S ENTRYGARD DUAL ARM OPERATORS

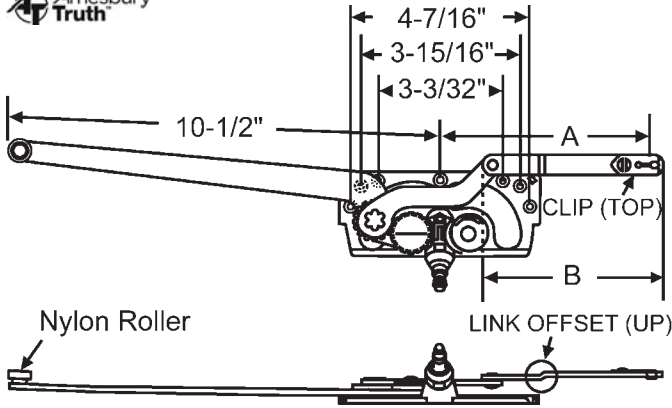

Part #	A	B	Hand	Link Offset	Clip	Finish
36-173	5-17/64"	4-7/16"	Shown	Up	Top	E-Gard
36-174	5-17/64"	4-7/16"	Opposite	Up	Top	E-Gard
36-181	5-17/64"	4-7/16"	Shown	Up	Top	Stainless Steel
36-182	5-17/64"	4-7/16"	Opposite	Up	Top	Stainless Steel
36-192	5-17/64"	4-7/16"	Shown	Down	Top	E-Gard
36-191	5-17/64"	4-7/16"	Opposite	Down	Top	E-Gard
36-183	2-59/64"	2-7/8"	Shown	Up	Top	E-Gard
36-184	2-59/64"	2-7/8"	Opposite	Up	Top	E-Gard
36-186	4-5/8"	3-3/4"	Shown	Up	Top	E-Gard
36-185	4-5/8"	3-3/4"	Opposite	Up	Top	E-Gard

Handle and cover sold separately. See Pages 213 - 218

Note: Detached clips can be reversed in the field.

### TRUTH'S ENTRYGARD DYAD ARM OPERATORS

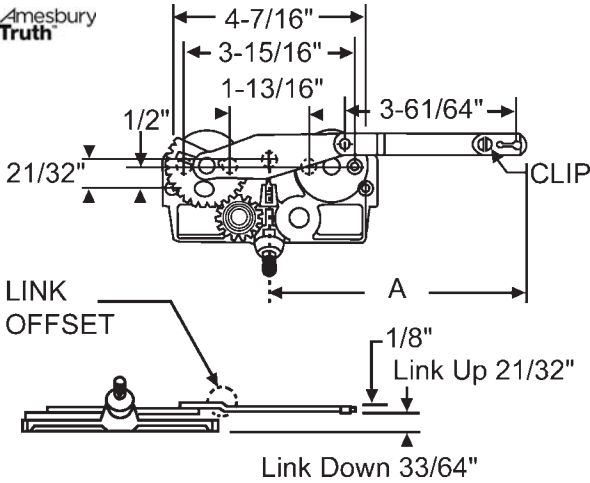

Part #	Hand	Link Offset	Clip	A	Arm
36-177	Shown	Down	Top	6"	Bent
36-178	Opposite	Down	Top	6"	Bent
36-177MOD	Shown	Down	Top	8-1/2"	Straight
36-178MOD	Opposite	Down	Top	8-1/2"	Straight
36-193	Shown	Up	Top	6"	Bent
36-194	Opposite	Up	Top	6"	Bent
36-199	Opposite	Down	Bottom	6"	Bent
36-199CG	Opposite	Down	Bottom	6"	Bent
36-200	Shown	Down	Bottom	6"	Bent
36-200CG	Shown	Down	Bottom	6"	Bent

Handle and cover sold separately. See Pages 213 - 218

Note: Detached clips can be reversed in the field.

### TRUTH'S ENTRYGARD SINGLE ARM OPERATORS

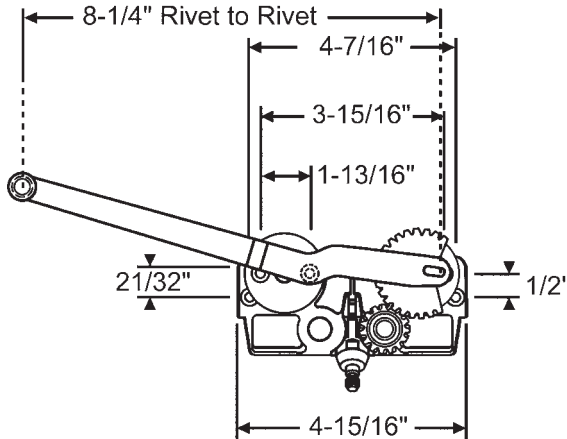

Part #	Hand
36-290LH	Shown
36-290RH	Opposite

Handle and cover sold separately. See Pages 213 - 218

### TRUTH'S ENTRYGARD FOLDING HANDLE CONVERSION KIT

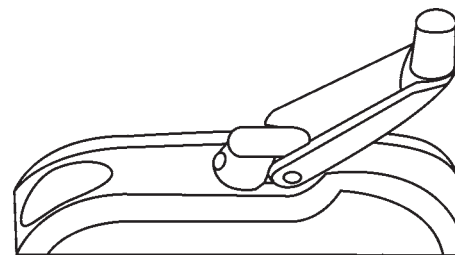

**Gives a Home a New Look!**

Converts crank handle to a folding handle. Just remove handle and cover, and install over operator.

Part #	Finish
37-220-1	Bronze
37-220-3	White

Before tightening set screw, close window and lock sash. Remove handle and reposition as shown.

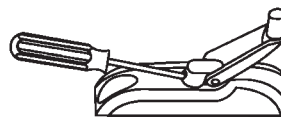

Tighten Set Screw

Folding Handle System.  
Non-Hand. Fits all Entrygard products.  
Other finishes available

# WINDOW REPLACEMENT HARDWARE

## SILL MOUNTED CASEMENT OPERATORS

### TRUTH'S CONCEALED OPERATORS

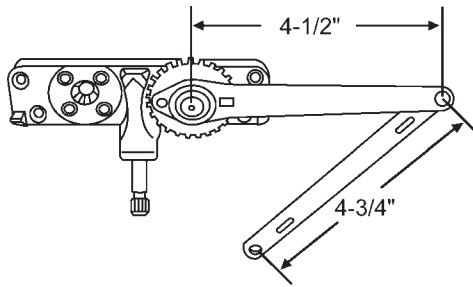

Part #	Hand	Finish	Description
36-282	Shown	E-Gard	Link Arm Mounted on Bottom, Offset Facing Up
36-366	Shown	E-Gard	Link Arm Mounted on Bottom, No Offset - Arm Straight
36-367	Opposite	E-Gard	Link Arm Mounted on Bottom, No Offset - Arm Straight
36-408	Shown	E-Gard	Link Arm Mounted on Bottom, Offset Facing Down
36-366A	Shown	E-Gard	Link Arm Mounted on Top, No Offset - Arm Straight

Handle sold separately. See Pages 214 - 218

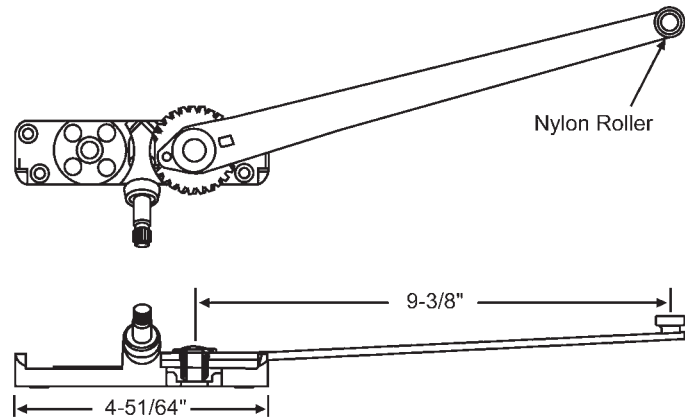

Part #	Hand
36-294	Shown

Handle sold separately. See Pages 214 - 218  
Concealed Single Arm Operator

## SILL MOUNTED CASEMENT OPERATORS

**NOTE:** Truth Hardware has Discontinued their 15 Series "Traditional Case" Style Operators. They will be replaced by the **Ellipse Case** which is a more Contour and Contemporary Design. They are a Direct Replacement, only difference is the case design.

Presently, we still have inventory on some of the Traditional Case Design; but once Our Stock has been depleted you will need to begin ordering the replacement Ellipse Case Design.

We have laid out Our Catalog pages showing both designs side by side to make this transition a little easier for your ordering.

### SINGLE ARM OPERATORS

#### TRUTH'S TRADITIONAL STYLE CASE

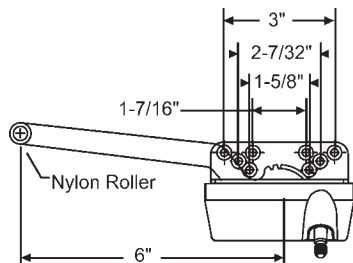

Part #	Hand	Finish
36-213-1S	Shown	Bronze
36-213-3S	Shown	White
36-211-3S	Opposite	White
36-213-6	Shown	Clay
36-211-6	Opposite	Clay

Handle sold separately. See Pages 214 - 218

#### TRUTH'S ELLIPSE STYLE CASE

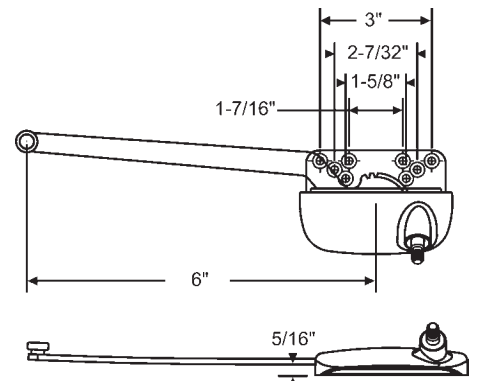

Part #	Hand	Finish
36-213-3E	Shown	White
36-211-3E	Opposite	White
36-213-1E	Shown	Bronze
36-211-1E	Opposite	Bronze

Handle sold separately. See Pages 214 - 218

# WINDOW REPLACEMENT HARDWARE

## SILL MOUNTED CASEMENT OPERATORS

### SINGLE ARM OPERATORS

#### TRUTH'S TRADITIONAL STYLE CASE

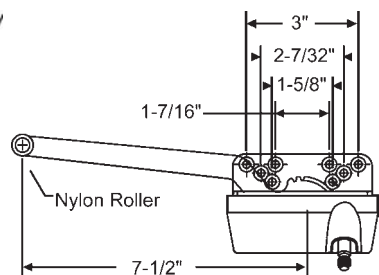

Part #	Hand	Finish
36-216-1S	Shown	Bronze
36-216-2S	Shown	Gold
36-215-2S	Opposite	Gold
36-216-3S	Shown	White
36-215-3S	Opposite	White

Handle sold separately. See Pages 214 - 218

#### TRUTH'S ELLIPSE STYLE CASE

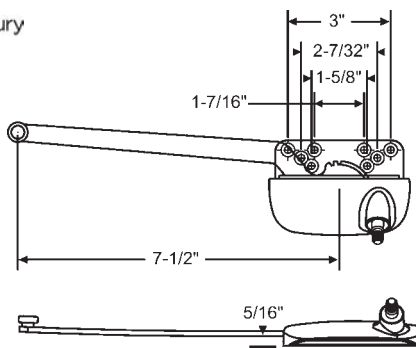

Part #	Hand	Finish
36-216-3E	Shown	White
36-215-3E	Opposite	White
36-216-1E	Shown	Bronze
36-215-1E	Opposite	Bronze

Handle sold separately. See Pages 214 - 218

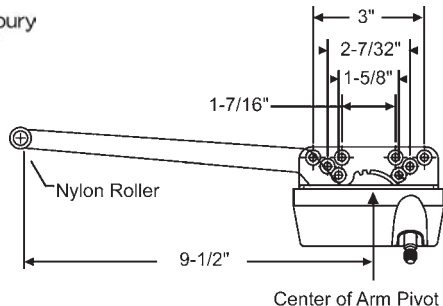

Part #	Hand	Finish
36-128-1S	Shown	Bronze
36-129-2S	Opposite	Gold
36-129-3S	Opposite	White

Handle sold separately. See Pages 214 - 218

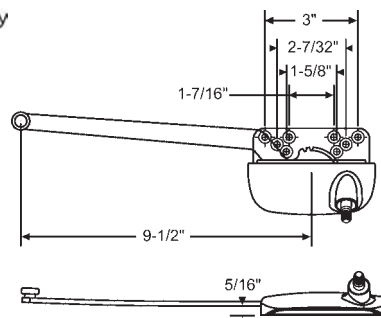

Part #	Hand	Finish
36-128-3E	Shown	White
36-129-3E	Opposite	White
36-128-1E	Shown	Bronze
36-129-1E	Opposite	Bronze
36-128-87E	Shown	Gold
36-129-87E	Opposite	Gold

Handle sold separately. See Pages 214 - 218

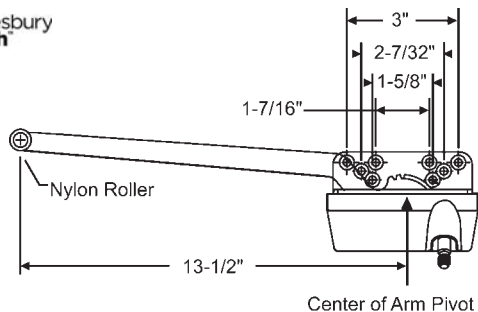

This operator is no longer available.  
Use Ellipse Style

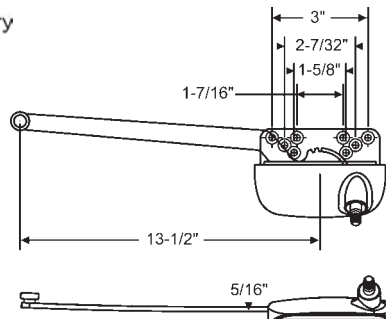

Part #	Hand	Finish
36-152-3E	Shown	White
36-154-3E	Opposite	White
36-152-1E	Shown	Bronze
36-154-1E	Opposite	Bronze
36-152-87E	Shown	Gold
36-154-87E	Opposite	Gold

Handle sold separately. See Pages 214 - 218

# WINDOW REPLACEMENT HARDWARE

## SILL MOUNTED CASEMENT OPERATORS

### SPLIT ARM OPERATORS

#### TRUTH'S TRADITIONAL STYLE CASE

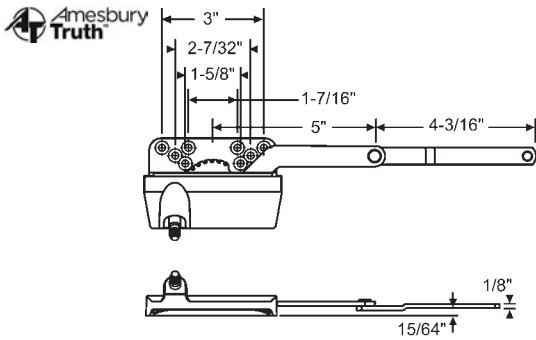

Part #	Hand	Finish
36-410-3S	Shown	White
36-411-3S	Opposite	White

Dyad Operator without Detach Clip

Uses: 39-21 and 39-22 stud brackets. Detach clip sold separately as 39-207.

Handle sold separately. See Pages 214 - 218

#### TRUTH'S ELLIPSE STYLE CASE

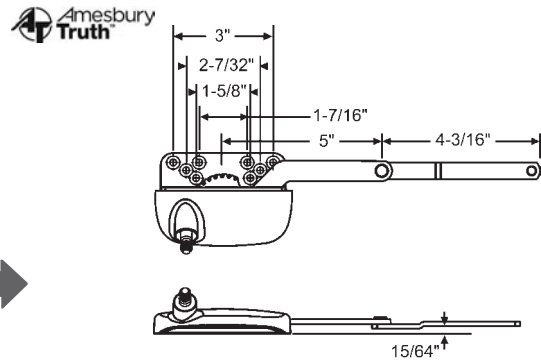

Part #	Hand	Finish
36-410-3E	Shown	White
36-411-3E	Opposite	White

Handle sold separately. See Pages 214 - 218

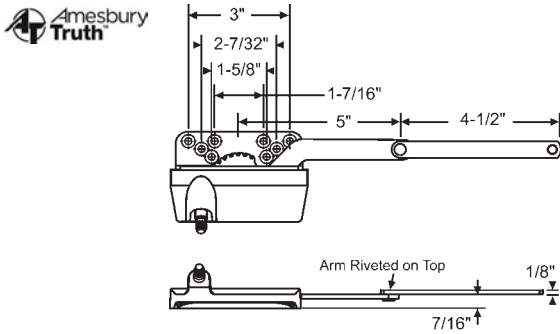

Part #	Hand	Finish
36-391-3S	Shown	White

Dyad Operator without Detach Clip

Uses: 39-21 and 39-22 stud brackets. Detach clip sold separately as 39-207.

Handle sold separately. See Pages 214 - 218

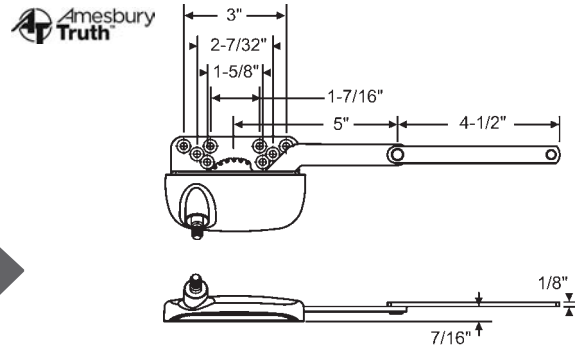

Part #	Hand	Finish
36-391-3E	Shown	White
36-390-3E	Opposite	White
36-391-2E	Shown	Gold
36-390-2E	Opposite	Gold

Handle sold separately. See Pages 214 - 218

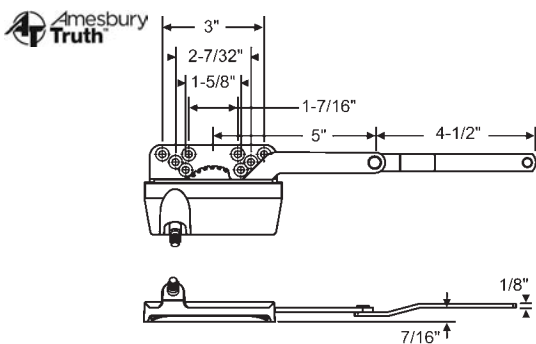

This operator is no longer available.  
Use Ellipse Style

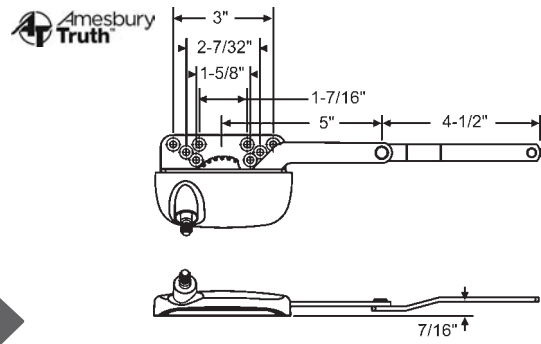

Part #	Hand	Finish
36-205-1E	Shown	Bronze
36-206-1E	Opposite	Bronze
36-205-3E	Shown	White
36-206-3E	Opposite	White
36-205-2E	Shown	Gold
36-206-2E	Opposite	Gold

Handle sold separately. See Pages 214 - 218

# WINDOW REPLACEMENT HARDWARE

## SILL MOUNTED CASEMENT OPERATORS

### SINGLE ARM OPERATORS

#### TRUTH'S TRADITIONAL STYLE CASE

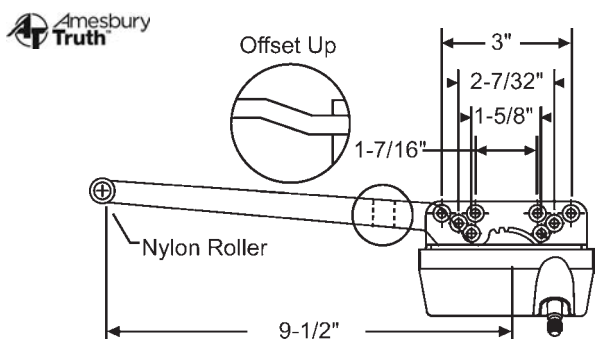

Part #	Hand	Finish
36-377-3S	Shown	White
36-378-3S	Opposite	White

Handle sold separately. See Pages 214 - 218

#### TRUTH'S ELLIPSE STYLE CASE

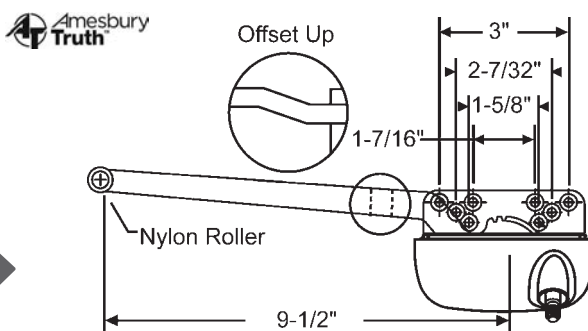

Part #	Hand	Finish
36-377-3E	Shown	White
36-378-3E	Opposite	White

Handle sold separately. See Pages 214 - 218

### SPLIT ARM OPERATORS

#### TRUTH'S TRADITIONAL STYLE CASE

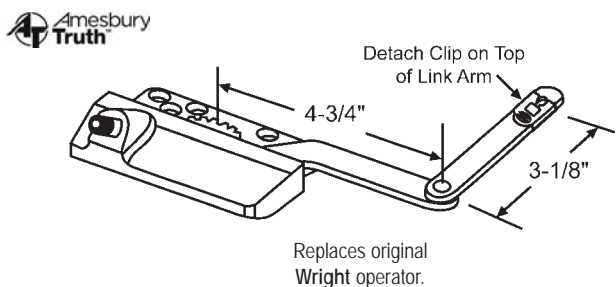

This operator is no longer available.  
Use Ellipse Style

#### TRUTH'S ELLIPSE STYLE CASE

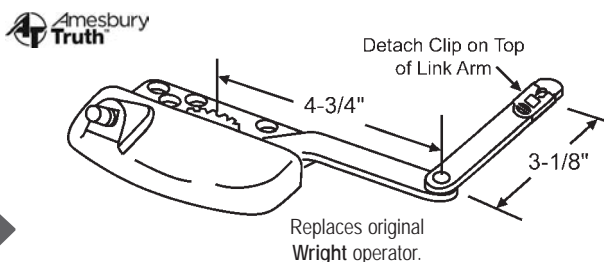

Part #	Hand	Finish
36-296-3E	Shown	White
36-295-3E	Opposite	White
36-296-2E	Shown	Gold
36-295-2E	Opposite	Gold

Split-Arm Operator

Handle sold separately. See Pages 214 - 218

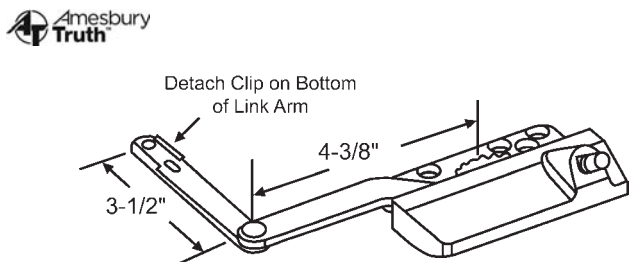

Part #	Hand	Finish
36-396-3	Shown	White

Split Arm Operator

Handle sold separately. See Pages 214 - 218

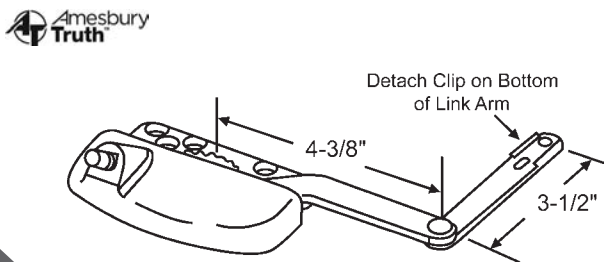

Part #	Hand	Finish
36-395-3E	Shown	White
36-396-3E	Opposite	White

Split Arm Operator

Handle sold separately. See Pages 214 - 218



# WINDOW REPLACEMENT HARDWARE

## SILL MOUNTED CASEMENT OPERATORS

### TRADITIONAL SINGLE ARM OPERATOR

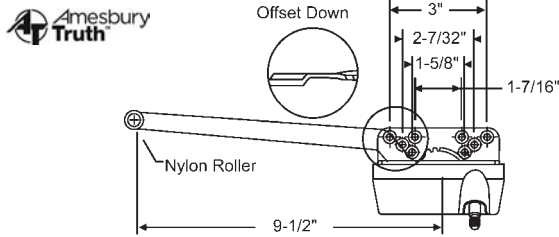

Part #	Hand	Finish
36-122-2S	Shown	Gold
36-123-2S	Opposite	Gold
36-122-3S	Shown	White
36-123-3S	Opposite	White

Handle sold separately. See Pages 214 - 218

### SPLIT ARM OPERATOR

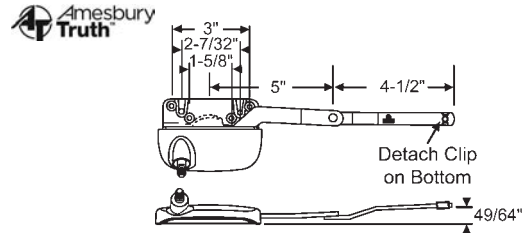

Part #	Hand	Finish
36-327-3E	Shown	White
36-328-3E	Opposite	White

Dyad Operator without Detach Clip

Note: Detached clips can be reversed in the field.

Handle sold separately. See Pages 214 - 218

### TRUTH'S MAXIM® SERIES OPERATORS

The Maxim® Series is a window operating "system" where the hinges and operators are developed to work together to meet or exceed the "maximum" performance requirements of larger, more versatile casement and awning windows.

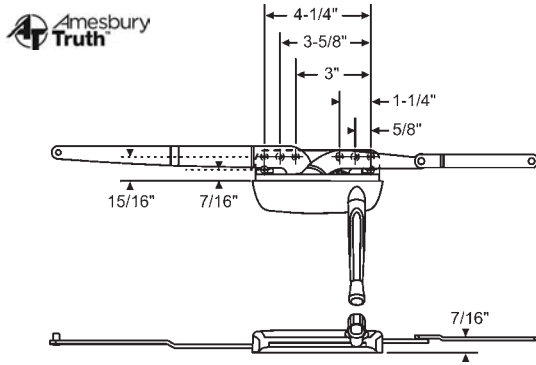

The Maxim® Series Dual Arm Operator is designed to operate sash sizes from 24" to 40" wide, 84" high and weighing up to 108 lbs.

Part #	Hand	Finish	Handle Only
36-368-1	Shown	Bronze	37-150-1
36-369-1	Opposite	Bronze	37-150-1
36-368-3	Shown	White	37-150-3
36-369-3	Opposite	White	37-150-3
36-368-9	Shown	Beige	37-150-9
36-369-9	Opposite	Beige	37-150-9
36-368-14	Shown	Cocoa Brown	37-150-14
36-369-14	Opposite	Cocoa Brown	37-150-14
36-368-2	Shown	Gold	37-150-2
36-369-2	Opposite	Gold	37-150-2

Handle sold separately. See Pages 214 - 218

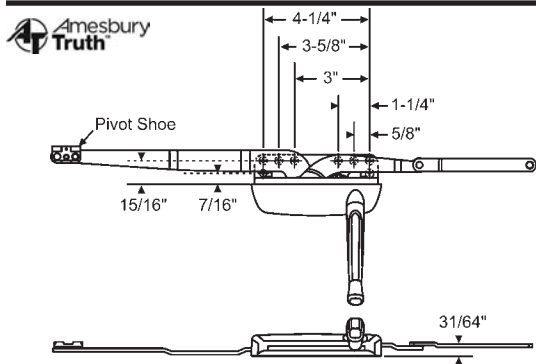

The Maxim® Series Dual Arm Low Profile Operator is designed to operate sash sizes up to 24" to 40" wide, 84" high and weighing up to 108 lbs.

Part #	Hand	Finish	Handle Only
36-464-3	Shown	White	37-150-3
36-465-3	Opposite	White	37-150-3
36-465-14	Opposite	Cocoa Brown	37-150-14

Handle sold separately. See Pages 214 - 218

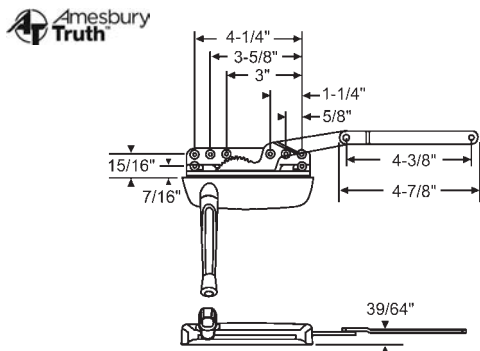

The Maxim® Series Dyad Operator is designed for narrow windows, but will operate a frame width from 16" to 32"; height up to 72" and a sash weight of up to 55 lbs.

Part #	Hand	Finish	Handle Only
36-371-1	Shown	Bronze	37-150-1
36-372-1	Opposite	Bronze	37-150-1
36-371-3	Shown	White	37-150-3
36-372-3	Opposite	White	37-150-3
36-371-9	Shown	Beige	37-150-9
36-372-9	Opposite	Beige	37-150-9
36-371-14	Shown	Cocoa Brown	37-150-14
36-372-14	Opposite	Cocoa Brown	37-150-14
36-371-29	Shown	Bright White	37-150-29
36-372-29	Opposite	Bright White	37-150-29

Handle sold separately. See Pages 214 - 218

# WINDOW REPLACEMENT HARDWARE

## SILL MOUNTED CASEMENT OPERATORS

### TRUTH'S MAXIM® SERIES OPERATORS

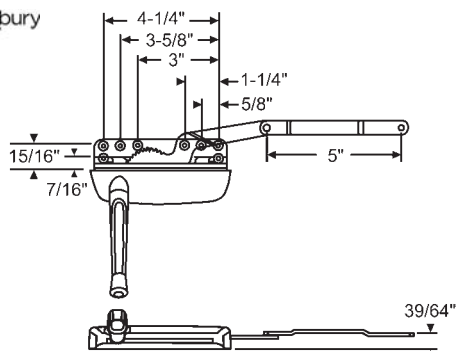

The Maxim® Series Reverse Dyad operators are designed for narrow windows, but will operate a frame width from 16" to 32"; height up to 72" and a sash weight up to 55 lbs.

Part #	Hand	Finish	Handle Only
36-373-1	Shown	Bronze	37-150-1
36-374-1	Opposite	Bronze	37-150-1
36-373-3	Shown	White	37-150-3
36-374-3	Opposite	White	37-150-3

Handle sold separately. See Pages 214 - 218

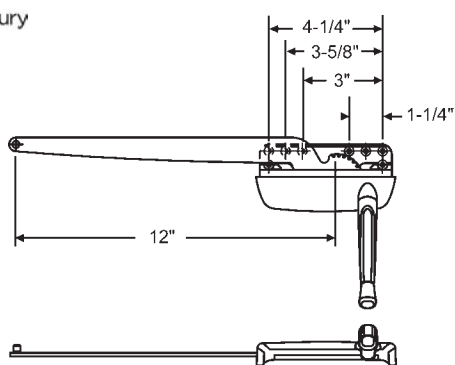

The Maxim® Series Single Arm operators are designed for casement windows that operate sash sizes from 20" to 32" wide, up to 72" high and weighing up to 73 lbs.

Part #	Hand	Finish
36-402-3	Shown	White
36-403-3	Opposite	White

Handle sold separately. See Pages 214 - 218

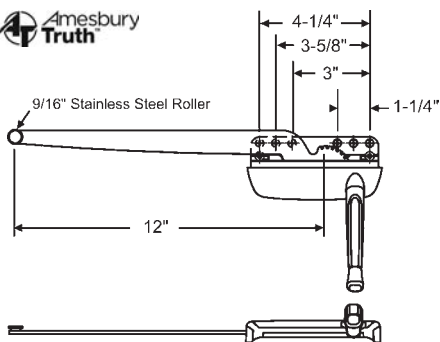

The Maxim® Series Single Arm low profile operators are designed for casement windows that operate sash sizes from 20" to 32" wide, up to 72" high and weighing up to 73 lbs.

Part #	Hand	Finish
36-428-3	Shown	White
36-429-3	Opposite	White
36-428-29	Shown	Bright White
36-429-29	Opposite	Bright White

Handle sold separately. See Pages 214 - 218

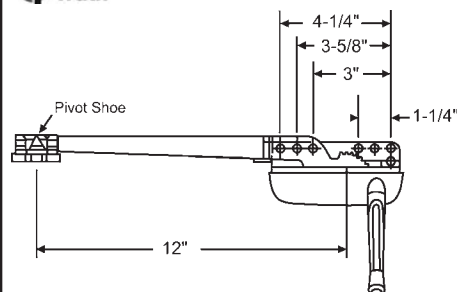

Part #	Hand	Finish
36-423-3	Shown	White
36-424-3	Opposite	White

Handle sold separately. See Pages 214 - 218

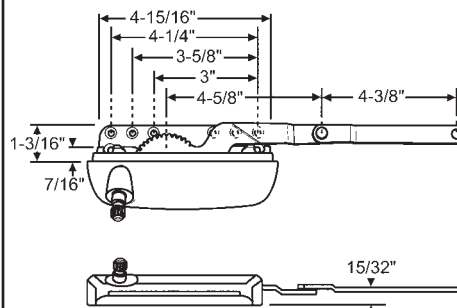

Part #	Hand	Finish
36-555-3	Shown	White
36-556-3	Opposite	White

Handle sold separately. See Pages 214 - 218

### MAXIM® FOLDING HANDLE & COVER



Converts crank handle to folding handle. Just snap onto top of operator.

**Gives a Home a New Look!**

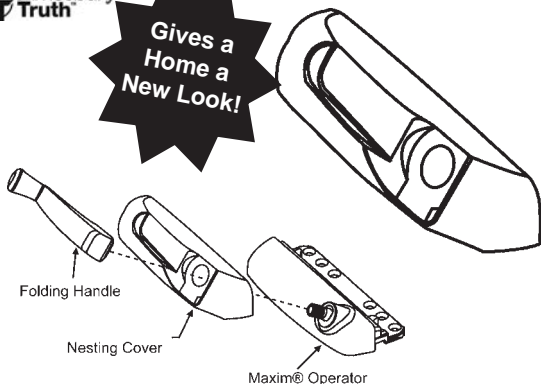

Part #	Hand	Finish
36-368NCV-1	Shown	Bronze
36-369NCV-1	Opposite	Bronze
36-368NCV-3	Shown	White
36-369NCV-3	Opposite	White

Plastic Nesting Cover for Maxim® Operators  
Furnished with double sided tape pre-applied to cover for attaching cover to Maxim® Operator

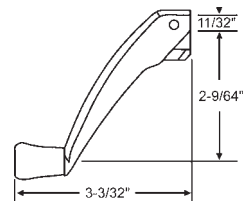

Part #	Finish
37-109FH-1	Bronze
37-109FH-3	White

Folding Handle (Must be ordered Separately)

# WINDOW REPLACEMENT HARDWARE

## SILL MOUNTED CASEMENT OPERATORS

### TRUTH'S ENCORE™ SYSTEM OPERATORS

The Encore™ family of operators are engineered to incorporate all the strengths and performance characteristics as Truth's Maxim® Series

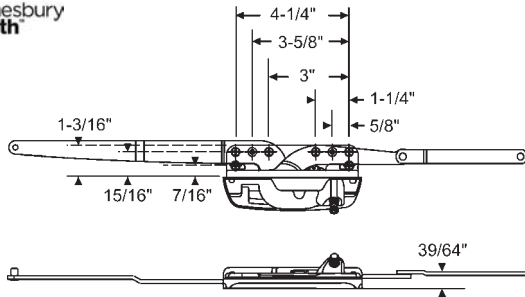

The Encore™ series dual arm operator is designed to operate sash sizes from 24" to 40" wide, up to 84" high and weighing up to 108 lbs.

Part #	Hand
36-368EN	Shown
36-369EN	Opposite

Handle and cover sold separately. See Pages 213 - 218

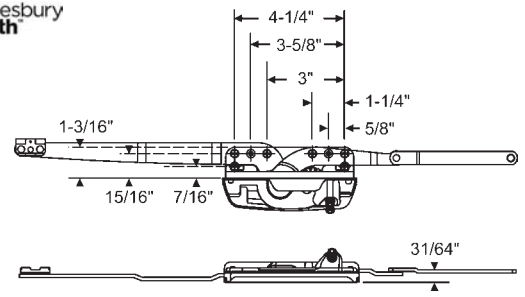

The Encore™ series dual arm low profile operator is designed to operate sash sizes from 24" to 40" wide, up to 84" high and weighing up to 108 lbs.

Part #	Hand
36-467EN	Shown
36-468EN	Opposite

Handle and cover sold separately. See Pages 213 - 218

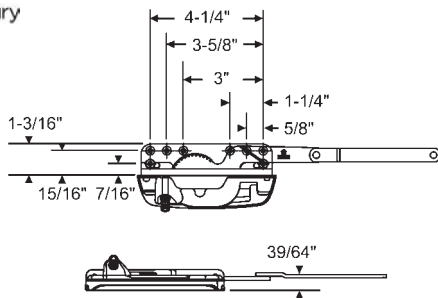

The Encore™ series dyad operator is designed for narrow windows and will operate sash sizes from 16" to 32" wide, up to 72" high and weighing up to 55 lbs.

Part #	Hand
36-371EN	Shown
36-372EN	Opposite

Handle and cover sold separately. See Pages 213 - 218

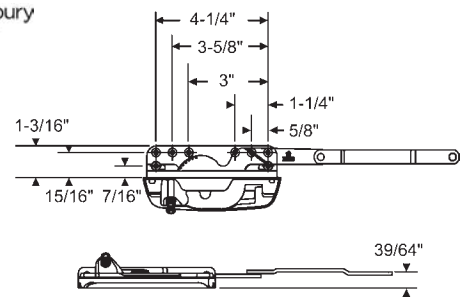

The Encore™ series reversed dyad operator is designed for narrow windows and will operate sash sizes from 16" to 32" wide, up to 72" high and weighing up to 55 lbs.

Part #	Hand
36-470EN	Shown
36-471EN	Opposite

Handle and cover sold separately. See Pages 213 - 218

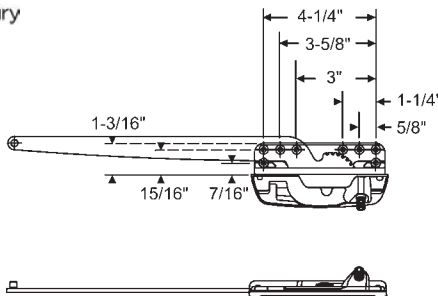

The Encore™ series single arm operators are designed for casement windows with sash sizes from 20" to 32" wide, up to 72" high and weighing up to 73 lbs.

Part #	Hand
36-402EN	Shown
36-403EN	Opposite

Handle and cover sold separately. See Pages 213 - 218

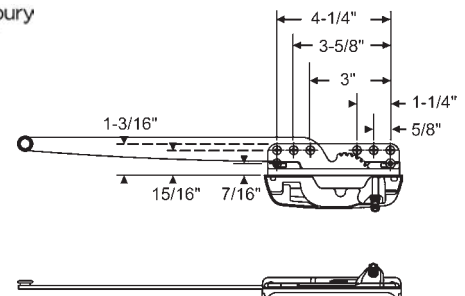

The Encore™ series single arm low profile operators are designed for casement windows with sash sizes from 20" to 32" wide, up to 72" high and weighing up to 73 lbs.

Part #	Hand
36-402ENLP	Shown
36-403ENLP	Opposite

Handle and cover sold separately. See Pages 213 - 218

### TRUTH'S ENCORE™ TANGO FOLDING HANDLE & COVER

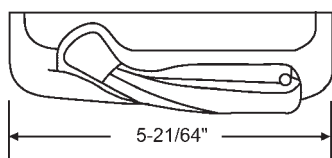

Part #	Hand	Finish
37-215-1	Shown	Bronze
37-216-1	Opposite	Bronze
37-215-3	Shown	White
37-216-3	Opposite	White
37-215-71	Shown	Oil Rubbed Bronze

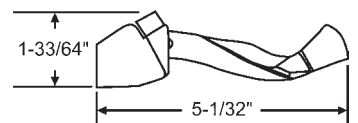

# WINDOW REPLACEMENT HARDWARE

## SILL MOUNTED CASEMENT OPERATORS

Sill Mounted Operators Sorted by Manufacturer

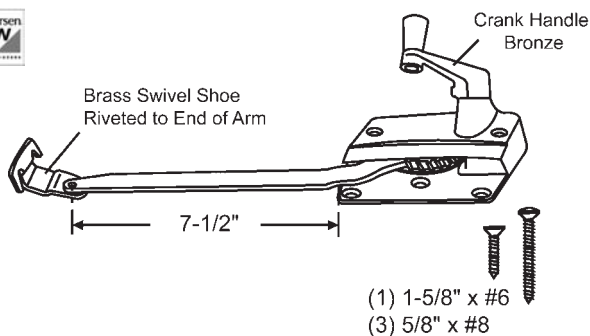

- (1) 1-5/8" x #6
- (3) 5/8" x #8

Part #	Hand	Finish
750-0536512	Shown	Bronze

Crank Handle Included

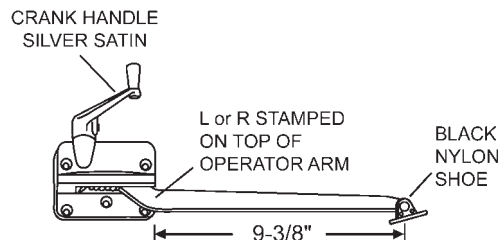

Part #	Hand	Finish	Handle Only
750-1360008	Shown	Silver Satin	750-1361008
750-1360012	Opposite	Silver Satin	750-1361008

Handle sold separately. See Pages 214 - 218  
Only available in Silver Satin finish.

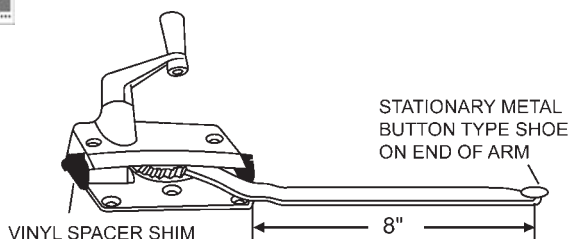

This operator is no longer available.  
Replace with new style operator and new style track.

Part #	Hand	Finish	New Style Track
750-0531008	Shown	Bronze	750-0532108
750-0531012	Opposite	Bronze	750-0532108

Handle Included

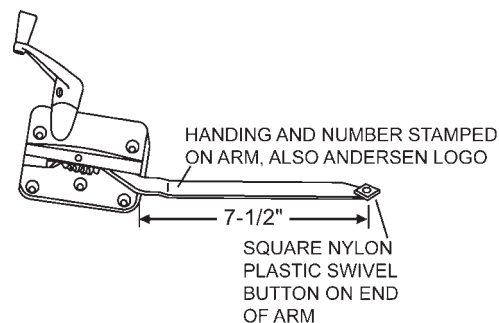

Part #	Hand	Finish
750-0531108	Shown	Bronze
750-0531112	Opposite	Bronze

Crank Handle Included

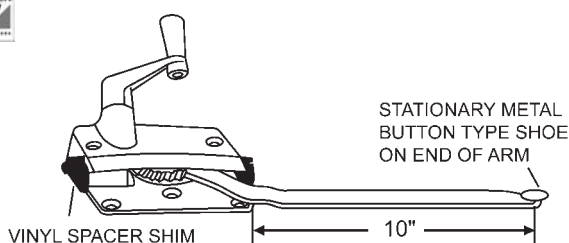

This operator is no longer available.  
Replace with new style operator and new style track.

Part #	Hand	Finish	New Style Track
750-0566008	Shown	Bronze	750-0532108
750-0566012	Opposite	Bronze	750-0532108

Handle Included

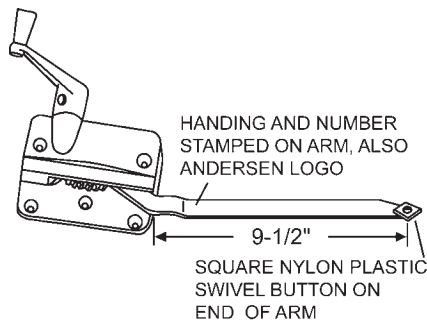

Part #	Hand	Finish
750-0566208	Shown	Bronze
750-0566212	Opposite	Bronze

Crank Handle Included

# WINDOW REPLACEMENT HARDWARE

## SILL MOUNTED CASEMENT OPERATORS

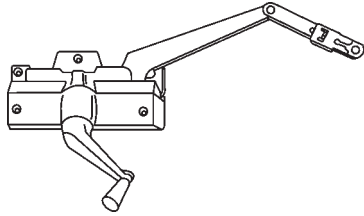

Part #	Hand	Finish	Handle Only
750-1361316	Shown	Stone	750-0532408
750-1361318	Opposite	Stone	750-0532408

Split Arm Operator

Handle sold separately. See Pages 214 - 218

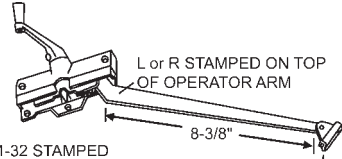

NO. 7191-32 STAMPED ON BOTTOM OF OPERATOR HOUSING

STONE NYLON SHOE WITH SLOT FOR CHANNEL. SHOE IS MOUNTED ON TOP OF OPERATOR ARM.

Part #	Hand	Finish	Handle Only
750-1361312	Shown	Stone	750-0532408
750-1361314	Opposite	Stone	750-0532408

Handle sold separately. See Pages 214 - 218

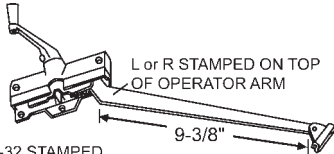

NO. 7191-32 STAMPED ON BOTTOM OF OPERATOR HOUSING

STONE NYLON SHOE WITH SLOT FOR CHANNEL. SHOE IS MOUNTED ON TOP OF OPERATOR ARM.

Part #	Hand	Finish	Handle Only
750-1361308C	Shown	Stone	750-0532408
750-1361310C	Opposite	Stone	750-0532408

Handle sold separately. See Pages 214 - 218

Operator assembly with cover, track and screws.

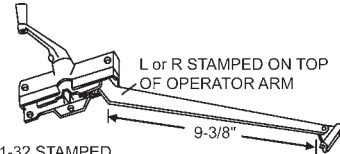

NO. 7191-32 STAMPED ON BOTTOM OF OPERATOR HOUSING

BLACK NYLON SHOE WITH SLOT FOR CHANNEL. SHOE IS MOUNTED UNDER OPERATOR ARM.

Part #	Hand	Finish	Handle Only
750-0565616	Shown	Stone	750-0532408
750-0565620	Opposite	Stone	750-0532408

Handle sold separately. See Pages 214 - 218

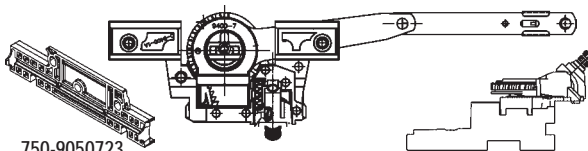

750-9050723  
Adapter Plate Included

Perma-Shield Enhanced Casement Split Arm Operator. **Non-handed**

Operator Part #	Sash Bracket	Bracket Hand	Type
750-1361399	750-1361409	LH	Standard
750-1361399	750-1361408	RH	Standard
750-1361933	750-1361411	LH	Corrosion Resistant
750-1361933	750-1361410	RH	Corrosion Resistant

Handle and cover sold separately. See Pages 213 - 218

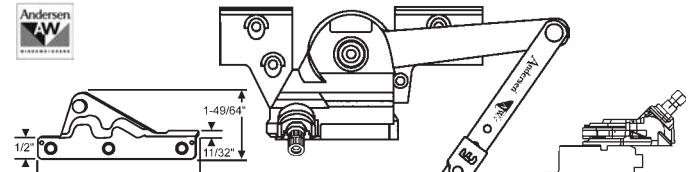

Perma-Shield Improved/E-Z Casement Split Arm Operator. **Non-handed**

Operator Part #	Sash Bracket	Bracket Hand	Type
750-1361484	750-1361409	LH	Standard
750-1361484	750-1361408	RH	Standard
750-1361481	750-1361411	LH	Corrosion Resistant
750-1361481	750-1361410	RH	Corrosion Resistant

Handle and cover sold separately. See Pages 213 - 218

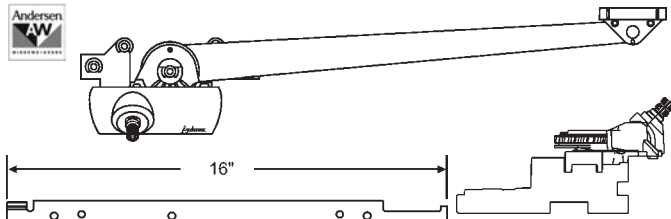

Part #	Hand	Track Only
750-9015119	Shown	750-1361414
750-9015120	Opposite	750-1361415

Perma-Shield Enhanced Casement Straight Arm Operator. Corrosion Resistant

Handle and cover sold separately. See Pages 213 - 218

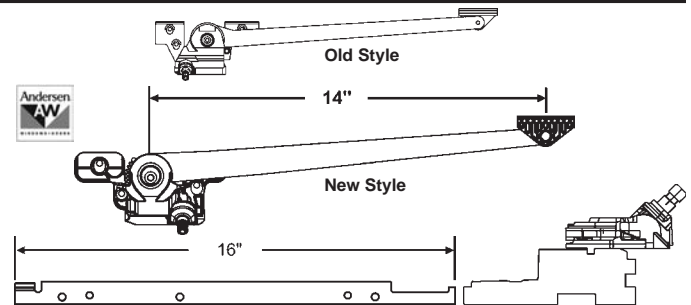

If Prior to 2001 you need to order a 750-9050723 adapter plate (sold separately)

Part #	Hand	Track Only
750-1361482	Shown	750-1361414
750-1361483	Opposite	750-1361415

Perma-Shield Improved/E-Z Casement Straight Arm Operator. Corrosion Resistant

Handle and cover sold separately. See Pages 213 - 218

# WINDOW REPLACEMENT HARDWARE

## SILL MOUNTED CASEMENT OPERATORS

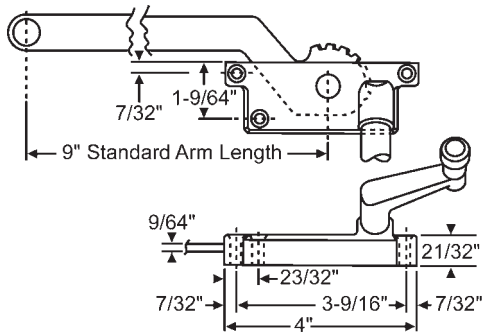

Part #	Hand	Finish
36-144	Shown	Bronze
36-145	Opposite	Bronze
36-144BG	Shown	Beige

Handle Included. Hand knobs use 5/16" size only.  
Additional handle only use 900-7821.

**DORCHESTER**

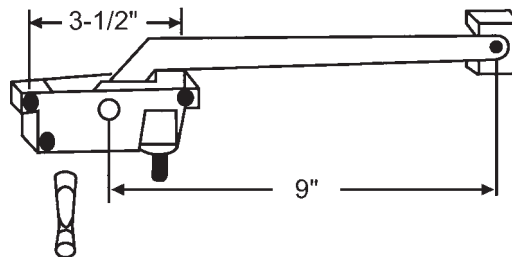

Part #	Hand	Finish
900-366LH	Shown	Bronze
900-366RH	Opposite	Bronze

Swing Lite Operator  
Handle Included. No Bar

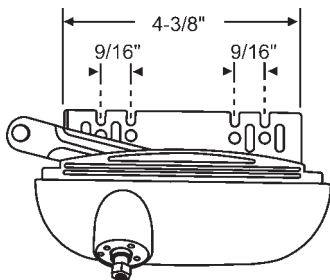

Part #	Hand	Finish
36-392LHW	Shown	White
36-392RHW	Opposite	White
36-392LHBEW	Shown	Blue White
36-392RHBEW	Opposite	Blue White
36-392LHAD	Shown	Almond
36-392RHAD	Opposite	Almond

Casement Split Arm.

Handle sold separately. See Pages 214 - 218

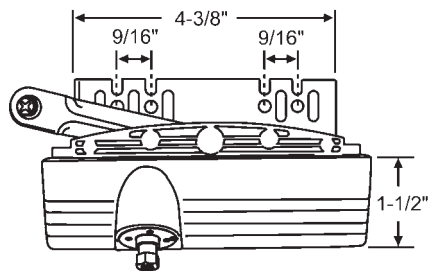

Part #	Hand	Finish
36-383LBG	Shown	Almond

Handle sold separately. See Pages 214 - 218

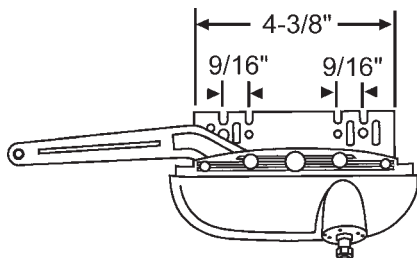

Part #	Hand	Finish
36-485RHW	Shown	White
36-485LHW	Opposite	White
36-485RHAD	Shown	Almond
36-485RHBEW	Shown	Blue White

Casement Operator with 6" Arm.

Handle sold separately. See Pages 214 - 218

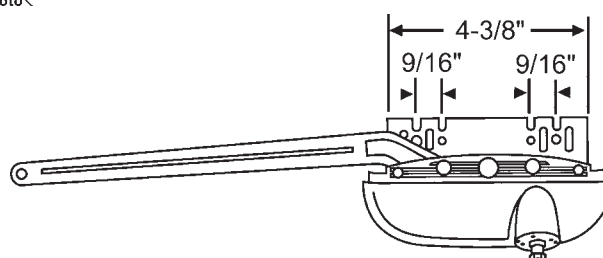

Part #	Hand	Finish
36-486RHBEW	Shown	Blue White
36-486LHBEW	Opposite	Blue White
36-486RHAD	Shown	Almond

Casement Operator with 10" Arm

Handle sold separately. See Pages 214 - 218

# WINDOW REPLACEMENT HARDWARE

## SILL MOUNTED CASEMENT OPERATORS

### ROTO X-DRIVE & PRO-DRIVE OPERATORS

Roto X-Drive operators are a direct replacement for Roto's Pro Drive operators.  
The Pro Drive operators take crank handles with a 5/16" hex male broach that snaps into the operator. See 37-221 on page 200

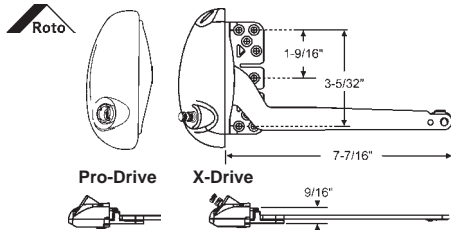

Part #	Hand	Finish	Style
36-498W-XD	Shown	White	X-Drive
36-497W-XD	Opposite	White	X-Drive
36-498AD	Shown	Almond	Pro-Drive
36-497AD	Opposite	Almond	Pro-Drive
36-498BEW	Shown	Blue White	Pro-Drive
36-497BEW	Opposite	Blue White	Pro-Drive
36-498EB	Shown	Earth Brown	Pro-Drive

7-1/2" Single Arm. For Vinyl Window Application.  
Handle sold separately. See Pages 214 - 218

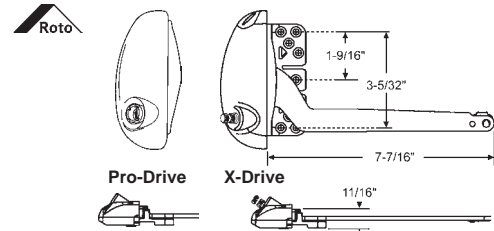

Part #	Hand	Finish	Style
36-496W-XD	Shown	White	X-Drive
36-495W-XD	Opposite	White	X-Drive
36-496W	Shown	White	Pro-Drive
36-495W	Opposite	White	Pro-Drive
36-496BEW	Shown	Blue White	Pro-Drive
36-496LAD	Shown	G2 Almond	Pro-Drive

7-1/2" Single Arm. Notched for Wood Application.  
Handle sold separately. See Pages 214 - 218

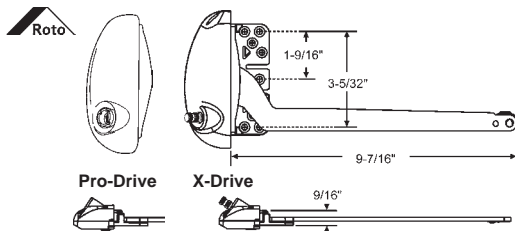

Part #	Hand	Finish	Style
36-500W-XD	Shown	White	X-Drive
36-501W-XD	Opposite	White	X-Drive
36-500BEW-XD	Shown	Blue White	X-Drive
36-501BEW-XD	Opposite	Blue White	X-Drive
36-500EB	Shown	Earth Brown	Pro-Drive
36-501EB	Opposite	Earth Brown	Pro-Drive
36-500MTBZ	Shown	Metallic Bronze	Pro-Drive
36-501MTBZ	Opposite	Metallic Bronze	Pro-Drive

9-1/2" Single Arm. For Vinyl Window Application.  
Handle sold separately. See Pages 214 - 218

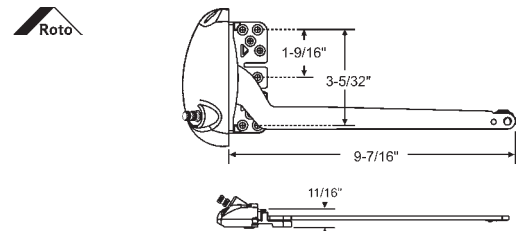

Part #	Hand	Finish	Style
36-490EW-XD	Shown	Euro White	X-Drive
36-491EW-XD	Opposite	Euro White	X-Drive

9-1/2" Single Arm. Notched for Wood Application.  
Handle sold separately. See Pages 214 - 218

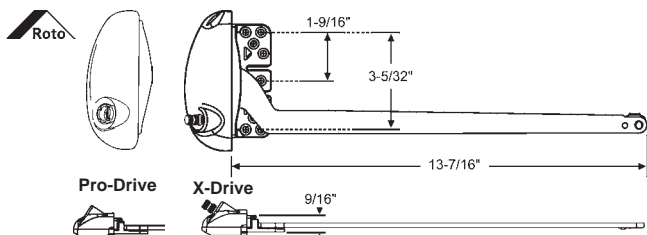

Part #	Hand	Finish	Style
36-514W-XD	Shown	White	X-Drive
36-510W-XD	Opposite	White	X-Drive
36-514AD	Shown	Almond	Pro-Drive
36-510AD	Opposite	Almond	Pro-Drive
36-514LAD	Shown	G2 Almond	Pro-Drive

13-1/2" Single Arm. For Vinyl Window Application.  
Handle sold separately. See Pages 214 - 218

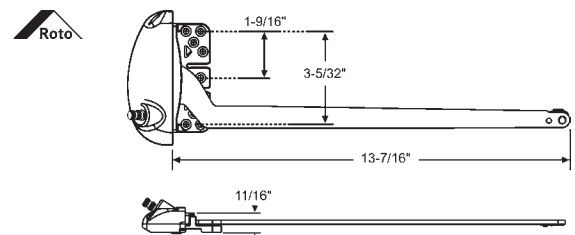

Part #	Hand	Finish	Style
36-543LHW-XD	Shown	White	X-Drive
36-543RHW-XD	Opposite	White	X-Drive

13-1/2" Single Arm. Notched for Wood Application.  
Handle sold separately. See Pages 214 - 218

# WINDOW REPLACEMENT HARDWARE

## SILL MOUNTED CASEMENT OPERATORS

### ROTO X-DRIVE OPERATORS

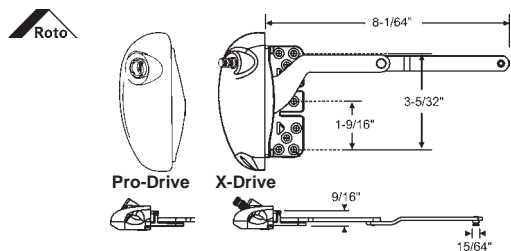

Part #	Hand	Finish	Style
36-511W-XD	Shown	White	X-Drive
36-525W-XD	Opposite	White	X-Drive
36-511AD	Shown	Almond	Pro-Drive
36-511BEW	Shown	Blue White	Pro-Drive
36-525BEW	Opposite	Blue White	Pro-Drive
36-511DBR	Shown	Dark Brown	Pro-Drive
36-525DBR	Opposite	Dark Brown	Pro-Drive
36-511EB	Shown	Earth Brown	Pro-Drive
36-525EB	Opposite	Earth Brown	Pro-Drive
36-511ORBZ	Shown	Oil Rubbed Bronze	Pro-Drive
36-525ORBZ	Opposite	Oil Rubbed Bronze	Pro-Drive

Split Arm. For Vinyl Window Application.  
Handle sold separately. See Pages 214 - 218

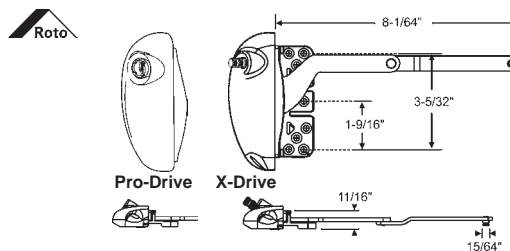

Part #	Hand	Finish	Style
36-539LHW-XD	Shown	White	X-Drive
36-539RHW-XD	Opposite	White	X-Drive
36-539LHW	Shown	White	Pro-Drive
36-539RHW	Opposite	White	Pro-Drive

Split Arm. Notched for Wood Application.  
Handle sold separately. See Pages 214 - 218

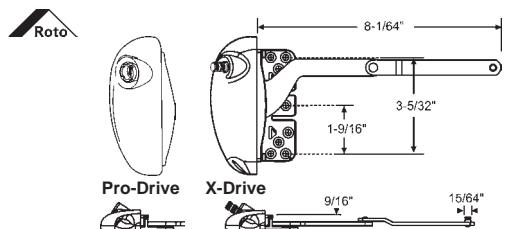

Part #	Hand	Finish	Style
36-508W-XD	Shown	White	X-Drive
36-509W-XD	Opposite	White	X-Drive
36-508EW	Shown	G1 White	Pro-Drive
36-509LAD	Opposite	G2 Almond	Pro-Drive

Split Arm Inverted. For Vinyl Window Application.  
Handle sold separately. See Pages 214 - 218

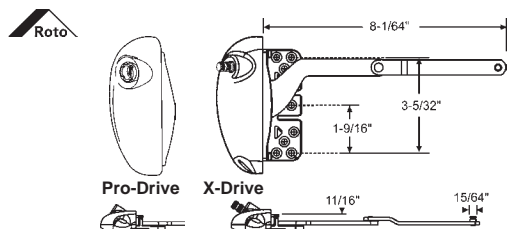

Part #	Hand	Finish	Style
36-540LHW-XD	Shown	White	X-Drive
36-540RHW-XD	Opposite	White	X-Drive
36-540LHW	Shown	White	Pro-Drive
36-540RHW	Opposite	White	Pro-Drive

Split Arm Inverted. Notched for Wood Application.  
Handle sold separately. See Pages 214 - 218

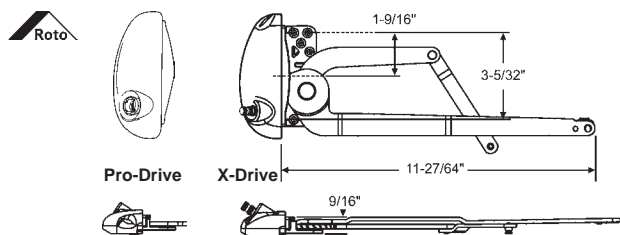

Part #	Hand	Finish	Style
36-517W-XD	Shown	White	X-Drive
36-518W-XD	Opposite	White	X-Drive
36-517DBR	Shown	Dark Brown	Pro-Drive
36-518DBR	Opposite	Dark Brown	Pro-Drive
36-517EB	Shown	Earth Brown	Pro-Drive
36-518EB	Opposite	Earth Brown	Pro-Drive
36-517W	Shown	White	Pro-Drive
36-518W	Opposite	White	Pro-Drive
36-518EW	Opposite	G1 White	Pro-Drive
36-517EW	Shown	G1 White	Pro-Drive

Dual Arm. For Vinyl Window Application.  
Handle sold separately. See Pages 214 - 218

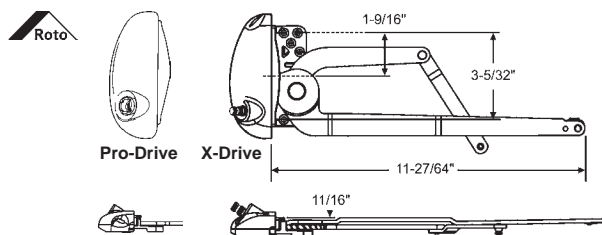

Part #	Hand	Finish	Style
36-528LHW-XD	Shown	White	X-Drive
36-528RHW-XD	Opposite	White	X-Drive
36-528LHW	Shown	White	Pro-Drive
36-528RHW	Opposite	White	Pro-Drive
36-528LHBEW	Shown	Blue White	Pro-Drive

Dual Arm. Notched for Wood Application.  
Handle sold separately. See Pages 214 - 218



# WINDOW REPLACEMENT HARDWARE

## SILL MOUNTED CASEMENT OPERATORS

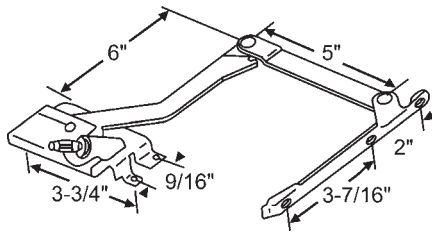

Part #	Hand
900-8865	Shown
900-8866	Opposite

Handle and cover sold separately. See Pages 213 - 218

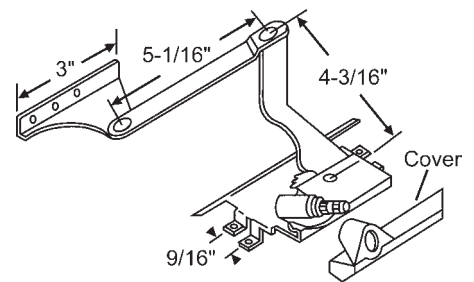

Part #	Hand
36-362	Shown
36-363	Opposite

Handle and cover sold separately. See Pages 213 - 218

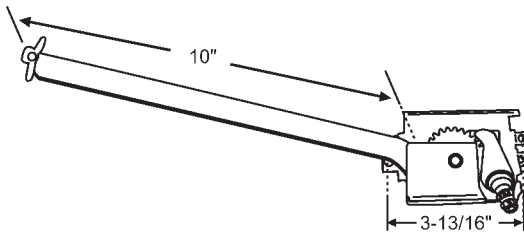

Part #	Hand
900-19619	Shown
900-19620	Opposite

Handle and cover sold separately. See Pages 213 - 218

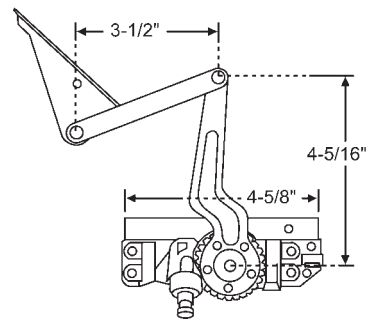

Part #	Hand
36-488	Shown
36-489	Opposite

Handle and cover sold separately. See Pages 213 - 218

Original GU Operators had a Plastic Housing. Currently Being Replaced with Metal Die Cast Housing and Stainless Steel Worm Gear and Arm.

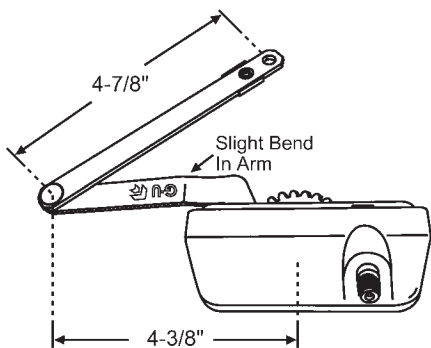

Part #	Hand	Finish	Handle
36-516RHWM	Shown	White	37-137-3
36-516LHWM	Opposite	White	37-137-3
36-516RHBGM	Shown	Beige	37-137-9
36-516LHBGM	Opposite	Beige	37-137-9

**GU/SILVERLINE**

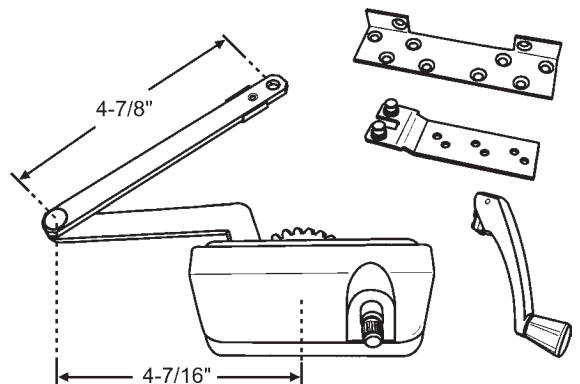

Part #	Hand	Finish
36-516RHWMA	Shown	White
36-516LHWMA	Opposite	White

DYAD Operator Kit. Fits GU

**SILVERLINE**

# WINDOW REPLACEMENT HARDWARE

## SILL MOUNTED CASEMENT OPERATORS

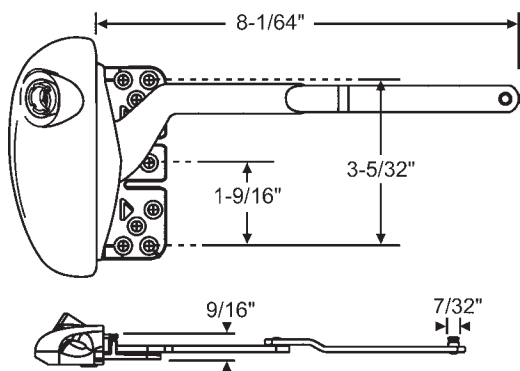

Part #	Hand
36-559LHBEW	Shown

Blue White. 3/16" Pin Height  
**SILVERLINE**

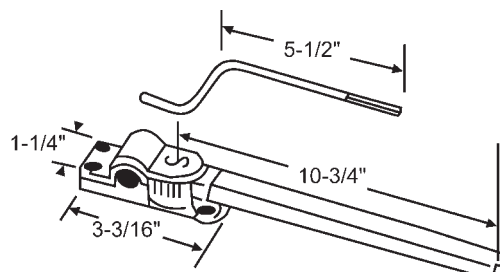

Part #	Finish
900-12962	Chrome Plated
900-12962BP	Brass Plated

Non-Hand  
Handle Included  
For Installation Instructions contact account manager.

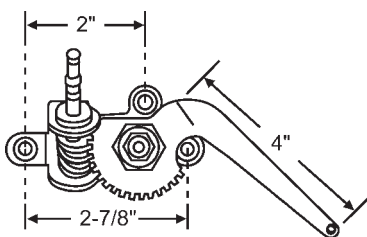

Part #
900-9834

Non-handed. Uses 900-9690 Crank Handle  
For Drag Link, See Page 219  
**PEACHTREE**

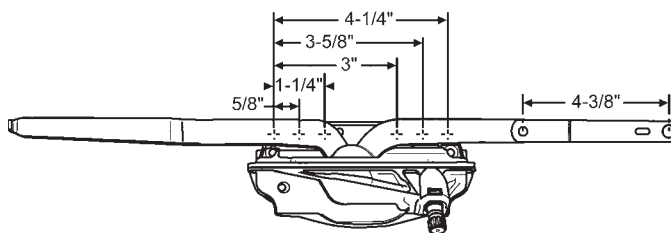

Part #	Hand
36-565SS	Shown
36-566SS	Opposite

Dual Arm Operator

### BILTBEST

Replaces old style operators with repair kit as shown below.

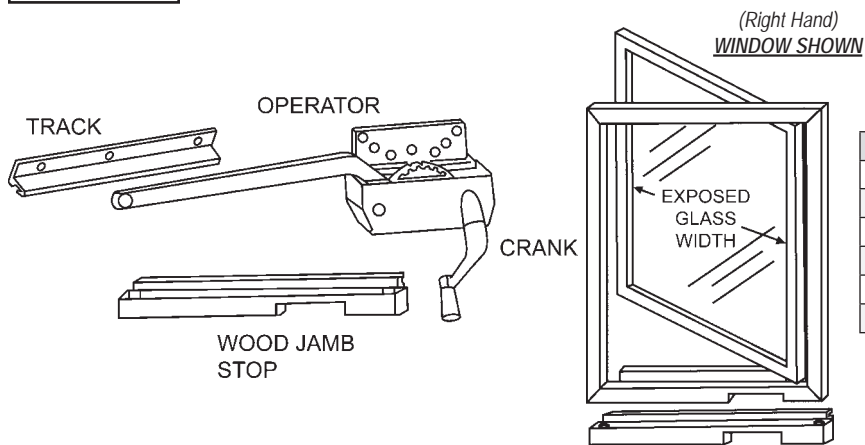

Part #	Glass Width Size	Hand	Sill Length
900-21850	14-5/8"	LH	16-1/8"
900-21849	14-5/8"	RH	16-1/8"
900-21852	19-1/8"	LH	20-5/8"
900-21851	19-1/8"	RH	20-5/8"
900-22703	22"	LH	24-7/16"
900-22703OP	22"	RH	24-7/16"

Casement Operator  
Replacement Kit

# WINDOW REPLACEMENT HARDWARE

## LEVER OPERATORS

Note: See lever operator brackets on page 206.

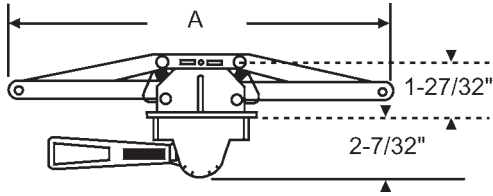

Part #	Hand	Finish	A
36-168-1	Shown	Bronze	13-1/8"
36-168-2	Shown	Gold	13-1/8"
36-168-3	Shown	White	13-1/8"
36-168-5	Shown	Bright Brass	13-1/8"
36-169-3	Opposite	White	13-1/8"
36-153-1	Shown	Bronze	20-1/2"
36-153-3	Shown	White	20-1/2"
36-153-5	Shown	Bright Brass	20-1/2"
36-157-1	Opposite	Bronze	20-1/2"
36-157-2	Opposite	Gold	20-1/2"
36-162-1	Shown	Bronze	23-1/4"
36-162-3	Shown	White	23-1/4"
36-163-1	Opposite	Bronze	23-1/4"
36-163-3	Opposite	White	23-1/4"
36-163-75	Opposite	Copper	23-1/4"

Other finishes available. Handle shown in locked position  
See Lever Operator Brackets on Page 211. Available with Removable Escutcheon

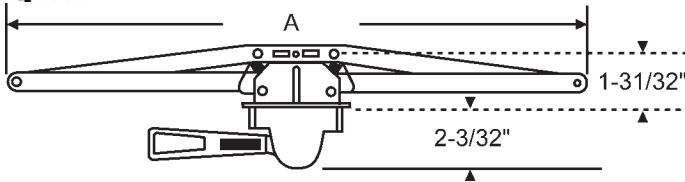

Part #	Hand	Finish	A
36-160-1	Shown	Bronze	20-1/2"
36-161-1	Opposite	Bronze	20-1/2"
36-161-2	Opposite	Gold	20-1/2"
36-166-1	Shown	Bronze	23-1/24"

Other finishes available. Handle shown in locked position  
See Lever Operator Brackets on Page 211

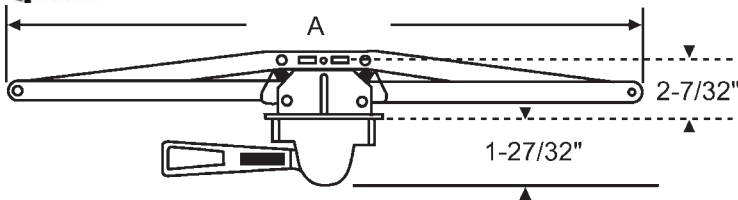

Part #	Hand	Finish	A
36-158-1	Shown	Bronze	20-1/2"
36-158-87	Shown	Gold	20-1/2"
36-159-2	Opposite	Gold	20-1/2"
36-164-1	Shown	Bronze	23-1/24"
36-164-87	Shown	Gold	23-1/24"

Other finishes available. Handle shown in locked position  
See Lever Operator Brackets on Page 211

## ROTO INVISIBLE MOTORIZED AND MANUAL SKYLIGHT OPERATOR SYSTEMS



Part #	Color
36-536SND	Sandstone
36-536W	White

Manual skylight operator with round end connector.

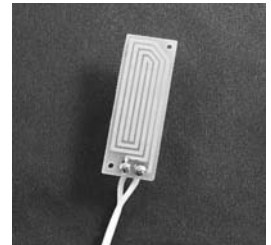

**39-803**

Motorized skylight conversion kit rain sensor only.

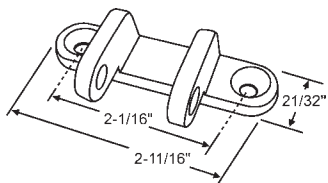

**39-792**

Mounting bracket only for round end connector. White



**39-838**

Mounting bracket pin for round end connector. White

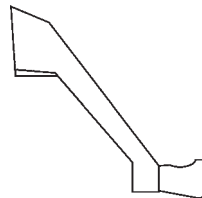

Part #	Color
37-235SND	Sandstone
37-235W	White

Handle for manual skylights with 5/16" hex spline

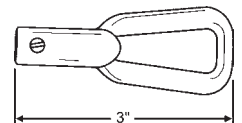

**39-492**

Eyelet with 5/16" hex spline  
Sandstone

# WINDOW REPLACEMENT HARDWARE

## MOTORIZED OPERATORS FOR SKYLIGHTS



Introducing Truth's next generation of power window system... Sentry II HS® for heavy skylights. Based on the powerful and reliable mechanics from our previous SkySentry® Motorization Systems, they've added a new digital electronics package with built in power conversion to take this system to a whole new level of service and reliability.

### Sentry II HS Motorized Skylight System & Synchronous Skylight Motor Kits 39-634

39-642  
Switch Only



39-640  
Remote Only



#### Cover for Sentry II HS

Part #	Color
39-637-3	White
39-637-7	Aluminum
39-637-8	Chestnut Bronze
39-637-9	Beige
39-637-15	Off White

Many Finishes Available

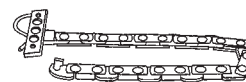
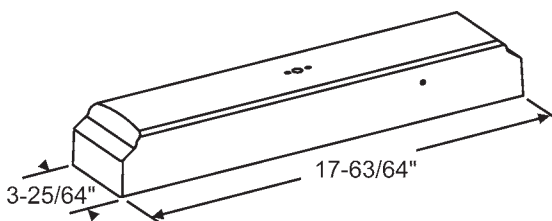

Part #	Length
39-388	12"
39-416	9"

Chain Assembly for Skylight Operator with Bracket & Pin

### The New Electronics Package provides many new features to enhance a home's comfort and its owner's peace of mind.

- **Quick and Easy Installation** of the skylight is possible when motor system is pre-installed and programmed by skylight manufacturer at their facility. The electrician needs only to connect line voltage power and the skylight is completely ready for operation -no further set up would be required by the installer or homeowner!
- **Power Conversion** built right into the skylight mounted control package which accepts direct connection of line voltages from 100 to 240 VAC at 47 to 440 Hz. No more transformers to complicate and add expense to the installation.
- **Power Blind System Compatible.** Centralized window control is now possible with Sentry II's ability to accept and control most 24 VDC power blind systems. The Sentry II RF remote or wall switch controls both skylight and blind motors for convenient, centralized control.
- **Power Protected Memory** eliminates the need to "reset" or retrain the control system after a power outage. Once the installation is complete, the motor never needs further service or adjustments -even after prolonged power outages!
- **RF Remote Compatibility** built into all motor control packages as a standard feature. Simply order the optional remote to add new and exciting control capability for the homeowner.

- **Rain Sensor**, standard on all kits, automatically closes the skylight at the first sign of moisture. Corrosion resistant sensor decreases mechanisms cleaning requirements and extends service life.
- **Easily Adapts** for new construction or retrofit applications. Please consult with your electrical contractor for a retrofit evaluation.
- **ETL Listed and CE Approved.** Meets all requirements for Class II installations.
- **Safety** -Automatic Motor Reversal has been engineered into the system which is intended to reverse the motor should an obstruction stop the skylight while closing. In addition, a screen interlock is provided which, when properly installed, electrically disconnects the motor when the screen is removed. These features are intended to help prevent personal injury which could result from reaching into the skylight area during its operation.
- **Synchronized Operation** of multiple motors is now standard on the HS motor system. The same Sentry II HS motor system can now be used on single motor applications or it can be ganged with up to four motor units on a large single skylight. Multiple motors on a single skylight add stability and capacity.
- **Awning Windows** -Can also be fitted with the Sentry II HS Motor System. Skylight hardware systems work great on awning windows with butt hinges.

#### SENTRY II HS CAPACITY

Truth's Sentry II HS for heavy skylights is load rated at 80 lbs. at the chain. This equates to a total skylight hatch weight of 160 lbs. Sentry II HS power skylight system is rated at 50 watts.

#### Sentry II HS for heavy skylights Order 1 per skylight

- 39-634 - Sentry II HS System
- 39-637-X - Cover (X denotes finish code)

#### Order 1 Hand Held Remote and/or Wall Switch

- 39-640 - Hand Held RF Remote
- 39-642 - Wall Switch

- **Building Automation Systems** can easily be tied into the control electronics for virtually limitless ventilation possibilities.

# WINDOW REPLACEMENT HARDWARE

## MOTORIZED OPERATORS FOR CASEMENT & AWNING WINDOWS



Introducing Truth's Next Generation of Power Window Systems... Sentry II WLS® for Windows and Light Skylights. Based on the powerful and reliable mechanics from their previous motorization system, they've added a new digital electronics package with built in power conversion. This New Sentry II WLS System truly takes over where Truth's Sentry 2000® left off.

Sentry II WLS Motorized Power Window & Skylight System  
**39-635**

Sentry II WLS Motorized Power Window & Skylight System for **Pella** Windows  
**39-636**



**39-640**  
Remote Only

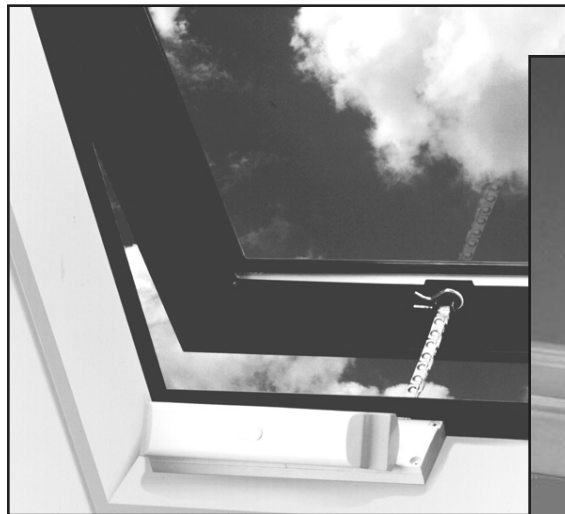

Cover for Sentry II WLS

Part #	Color
39-638-1	Bronze
39-638-3	White
39-638-35	Champagne
39-638-7	Aluminum

Many Finishes Available

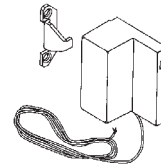
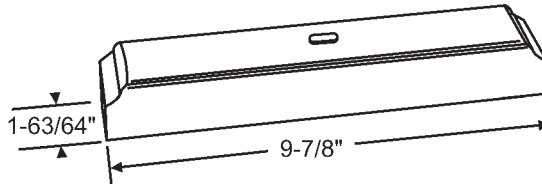

Part #	Color
39-326-1	Bronze
39-326-3	White

Motorized Sash Lock Kit.  
Includes Lock, Decorative Cover  
and Hardware Pack

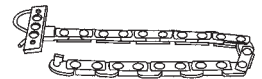

Part #	Length
39-388	12"
39-416	9"

Chain Assembly for Skylight  
Operator with Bracket & Pin

### The New Electronics Package provides many new features to enhance a home's comfort and its owner's peace of mind.

- **Retrofits** onto casement and awning windows and light skylights operated with a hand crank manufactured by Truth Hardware. The motor system drives the same input the handle is attached to.
- **Power Conversion** built right into the wall mounted control package which accepts direct connection of line voltages from 100 to 240 VAC at 47 to 440 Hz. No more transformers to complicate and add expense to the installation.
- **Power Blind System Compatible.** Centralized power window system control is now possible with Sentry II's ability to accept and control most 24 VDC power blind systems. The Sentry II's remote and wall switch can be used to control both window and blind motors for convenient, centralized control.
- **Power Protected Memory** eliminates the need to "reset" or retrain the motor after a power outage. Once the installation is complete the motor never needs further service or adjustments – even after prolonged power outages!
- **RF remote compatibility** built into all motor control packages as a standard feature. Simply order the optional remote to add new and exciting control capability for the homeowner.

- **Rain Sensor** -standard with all kits, automatically closes the window or skylight at the first sign of moisture. Corrosion resistant sensor decreases maintenance cleaning requirements and extends service life.
- **No Special Preparation** is required by the window or skylight manufacturer. The kits are suitable for new construction or retrofit applications. Please consult with your electrical contractor for a retrofit evaluation.
- **ETL Listed and CE Approved.** Meets all requirements for Class II installations.
- **Safety** - Automatic motor reversal has been engineered into the system which is intended to reverse the motor should an obstruction stop the window while closing. In addition, a screen interlock is provided which, when properly installed, electrically disconnects the motor when the screen is removed. These features are intended to help prevent personal injury which could result from reaching into the window area during its operation.
- **Motorized Sash Locks** are available for use with the WLS system for casement and awning windows.
- **Building Automation Systems** can easily be tied into the control electronics for virtually limitless ventilation possibilities.

### SENTRY II WLS CAPACITY

- When used on light skylights, Truth's Sentry II WLS is load rated at 40 lbs at the chain. This equates to a total skylight hatch weight of 80 lbs.
- When used on casement windows, the Sentry II WLS is designed to work on all window systems meeting the AAMA-101 hardware load requirements.
- When used on awning windows, the Sentry II WLS is designed to work on awning windows with a properly sized counter-balance hinge and operator. (Consult awning operator specifications).

Sentry II WLS for windows and light skylights  
**Order 1 each per window:**

- 39-635 - Sentry II WLS System
- 39-638-X - Cover (X denotes finish code)

**Order 1 Hand Held Remote (optional):**

- 39-640 - Hand Held RF Remote

# WINDOW REPLACEMENT HARDWARE

MOTORIZED OPERATORS FOR SKYLIGHTS, CASEMENT & AWNING WINDOWS



## NEW Marvel™ Sleek and Petite Motorized Operating System

Truth Hardware's new Marvel™ power operator system for windows and skylights proves that simpler can be better. Challenged with the expectation of window and skylight manufacturers with providing a small and sleek motorized system that is simple to install, easy to operate and above all affordable—Truth is confident that the Marvel System is the answer.

### Easy to Install and Operate

With installation templates provided in each kit, the mounting brackets used to help secure the Marvel Operator to the center of your window makes this system one of the easiest systems to install.

- Three styles of mounting brackets accompany this product to allow for easy mounting.
- Can be face-mounted or mounted to applications with sills.
- Rated to lift skylight sashes that weigh up to 90 lbs.
- Rated for use in outdoor applications only.
- Controlled using a standard, single pole / double throw, center off momentary contact switch. (Not Supplied)
- Durable double link chain produces 9.5" of chain travel.
- Electronic limit switch controls the opening position while the closing position is controlled through an internal current sensing feature.
- Users can operate multiple units from one control switch.

Note: When used on awning windows, the Marvel System is designed to work on awning windows with a properly sized counter balance hinge such as Truth 13 series or 34 series hinges.

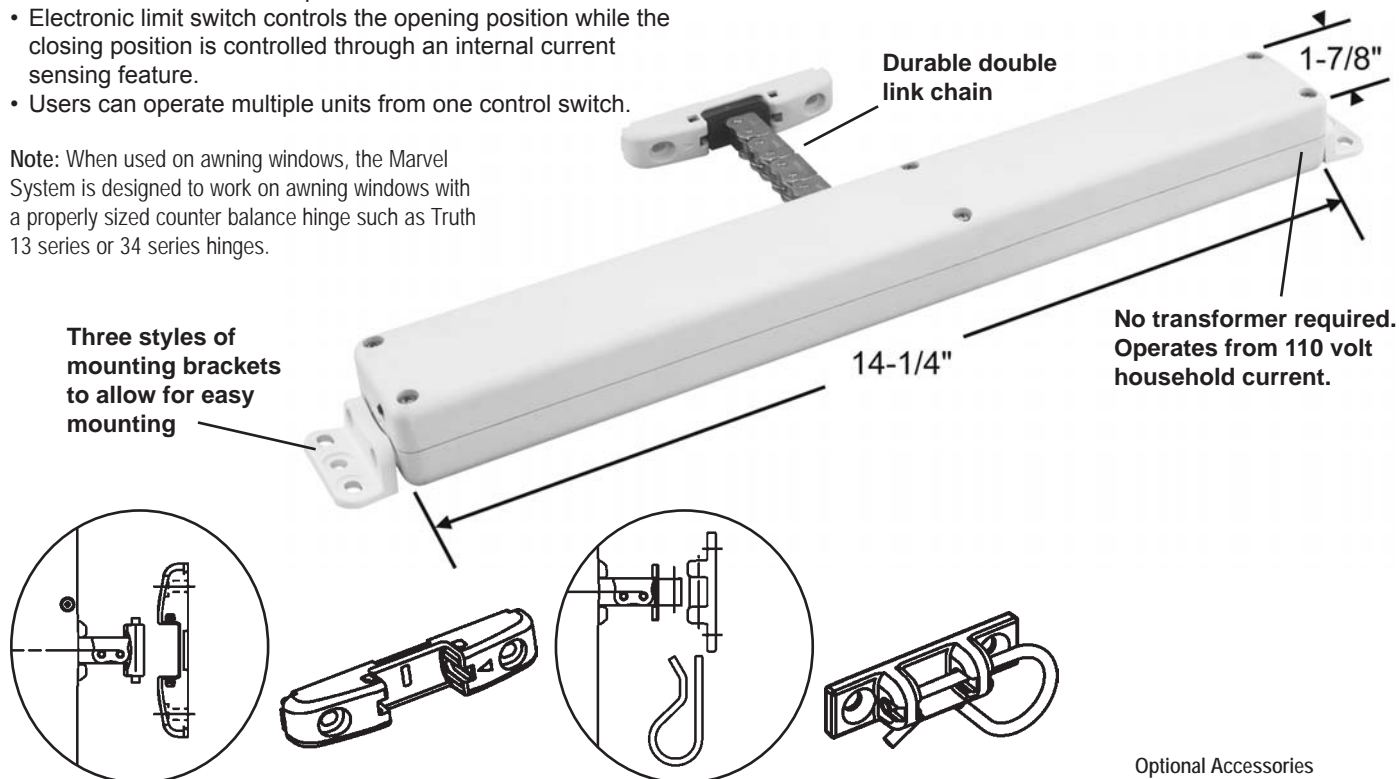

Three styles of mounting brackets to allow for easy mounting

No transformer required. Operates from 110 volt household current.

Snap Bracket Type

Part #	Truth #	Finish
39-760-1	42.90.03.100	Bronze
39-760-32	42.90.38.100	White (Weathershield)

Pull Pin Bracket Type

Part #	Truth #	Finish
39-789-1	42.90.03.101	Bronze
39-789-32	42.90.38.101	White

Optional Accessories

Part #	Description
39-886	Switch
39-840	Receiver
39-841	Remote with Wall Mount
39-908	Rain Sensor

# WINDOW REPLACEMENT HARDWARE

## MANUAL SKYLIGHT OPERATORS



### Add Value to Your Operable Skylight

The Truth Skylight Operator System offers you the flexibility the marketplace demands, the quality your windows deserve, easy factory or field installation and a means to keep your skylight hardware inventories both cost effective and efficient. The Truth Skylight Operator system is easy to install and compatible with wood, metal or vinyl framed skylights. Upgrading is easier and faster. Truth's special high gear reduction provides the low torque needed to lift a maximum sash weight of 160 pounds. Choose from two Manual Drive modules for the application that best meets your needs. Each easily mounts to the base module.

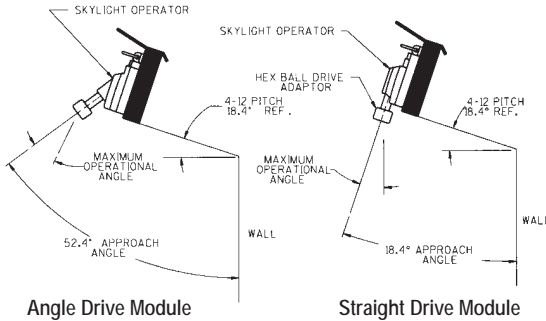

### Angle Drive

Part #	Color
36-342-1	Bronze
36-342-3	White

### Straight Drive

Part #	Color
36-345-1	Bronze
36-345-3	White

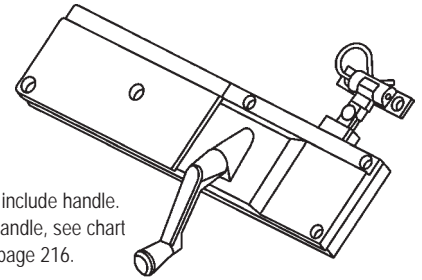

Does not include handle.  
 To order handle, see chart on page 216.

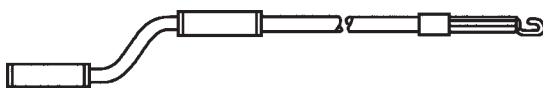

Description	Part #	Collapsed	Extended
Pole with Hook	39-198	48"	73"
Pole with Hook	39-102	74-1/8"	122-3/4"



Description	Part #	Collapsed	Extended
Pole with Hex Ball	39-199	48"	73"
Pole with Hex Ball	39-101	73-3/8"	122"



**39-94**  
Hex Ball Drive

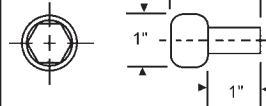

Part #	Color
39-100-1	Bronze
39-100-3	White

Hex Ball Adapter

### Fits Truth

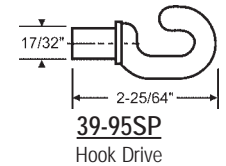
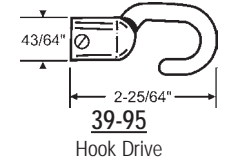

### Fits Truth

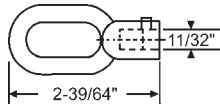

Part #	Color
39-97	Unpainted
39-97-1	Bronze
39-97-3	White

Eyelet Adapter. Fits Truth

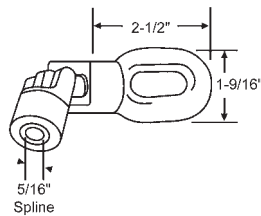

**900-15576**  
5/16" Universal Joint  
Aluminum Finish

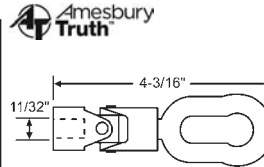

Part #	Color
39-115-1	Bronze
39-115-3	White
39-115-7	Aluminum

Universal with Pole Ring

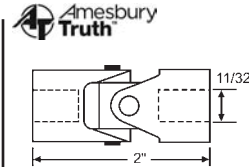

Part #	Color
39-116-1	Bronze
39-116-3	White
39-116-7	Aluminum

Universal Adaptor

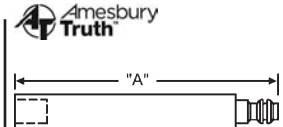

Part #	Color	A
39-118-1	Bronze	2"
39-118-3	White	2"
39-119-1	Bronze	4"
39-119-3	White	4"

11/32" Male/Female Handle Extension

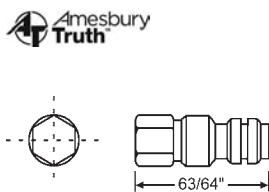

**39-117**  
Insert

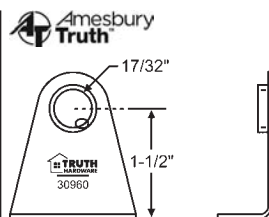

Part #	Color
39-125-1	Bronze
39-125-3	White
39-125-7	Aluminum

Bearing Bracket

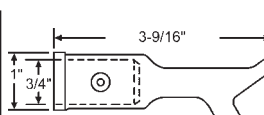

**900-16815**  
White Bronze Pole Hook

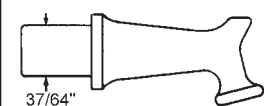

**900-16843**  
Pole Hook

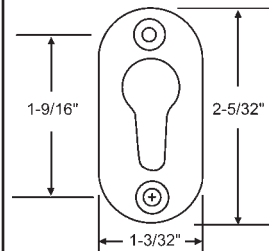

**900-16844**  
Pole Hook Hanger  
White Bronze

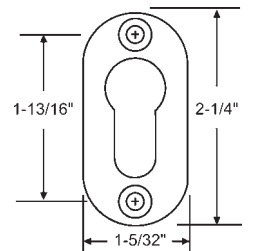

**900-16845A**  
Pole Hook Hanger  
White Bronze

# WINDOW REPLACEMENT HARDWARE

## SKYLIGHT ACCESSORIES

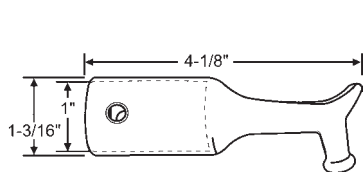

**900-11299**  
Aluminum Pole Hook

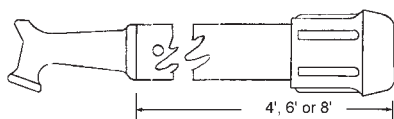

Part #	Length
900-16842-4	4'
900-16842-6	6'
900-16842-8	8'

Pole Hook Assembly  
Aluminum Tube with Rubber End



**900-18245**  
Rubber Tip Only

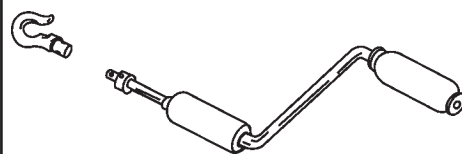

Part #	Description
39-672	CL Pole with AGR & HK - 5'
39-673	CL Pole 5' Extension

## VELUX SKYLIGHT OPERATOR & ACCESSORIES

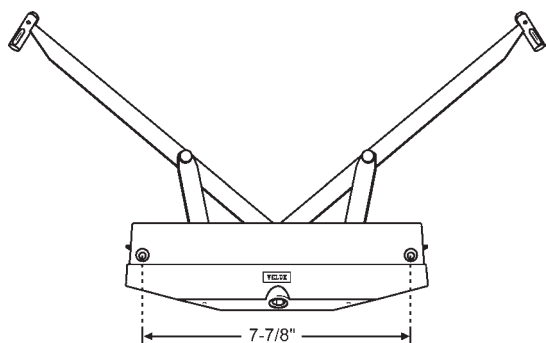

**900-21657**  
10" Split Arm Operator. Gold

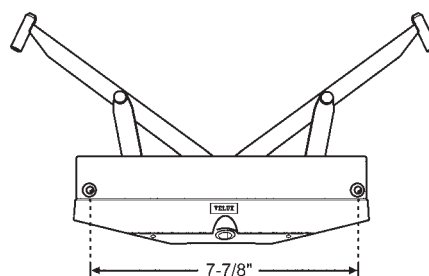

**900-21658**  
8" Split Arm Operator. Gold  
Must Order Snap-In Hex Adapter Separately.

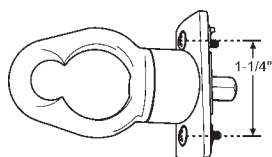

**37-180**  
Hook Adapter for Skylight

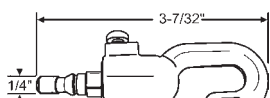

**39-755**  
Hook for Velux Operator

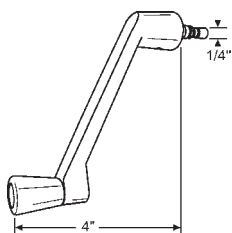

**37-171**  
Long Handle for Velux Operators

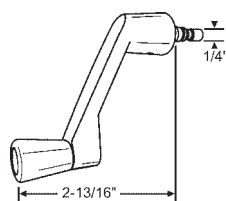

**37-172**  
Short Handle for Velux Operators

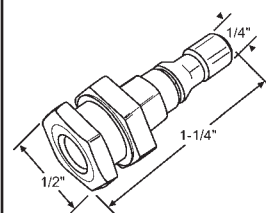

**900-22073**  
Snap-In Metal Hex Adapter

## REAR MOUNT AWNING OPERATOR

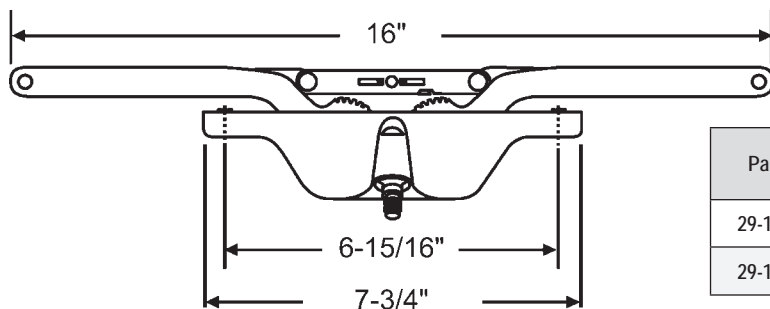

Part #	Finish	Mounting Style
29-174-4	Coppertone	Rear
29-174-9	Beige	Rear



## CLERESTORY WINDOW WANDS

Put those operable clerestory windows to energy-saving use with our 39-series clerestory extension crank. High mounted windows are excellent for capturing light while providing privacy, but they can also be "excellent" heat traps. It is now possible to vent the heat that rises to these areas as easily as opening any other window in the home.

It's inexpensive and can easily retrofit to existing or new window installations. By simple removal of the existing crank handle and replacement with an adapter (see adapter selection chart), the crank will open and close any operable clerestory window. It is not necessary to replace the current operator. Remember that you will only need one clerestory crank to operate all windows at the same height.

The removable extension crank is available in many standard sizes for either sill or jamb mounted operators. Refer to the selection chart to the right. The standard finish for the crank is natural anodized aluminum.

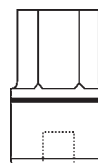
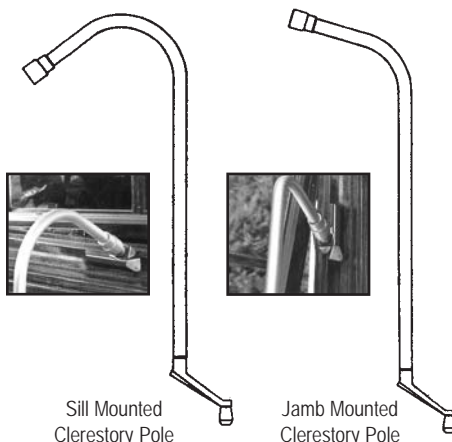

Female



Male

### Female Crank Handle Adapters

Part #	Fits
39-105PELLA	Pella
39-105	Truth, Marvin, Caradco, Weather Shield, Hurd, Biltbest, Eagle, Vetter, Others
39-105PT	Getty, Peachtree
39-105HEX	Milgard
39-105ROTO-NEW	Roto X-Drive (OPO6)

### Male Crank Handle Adapters

Part #	Fits
39-105ROTO-OLD	Roto Pro Drive (OPO5)

Adapters Used with Clerestory Window Wands

### Manual Window Wand Selection Chart



Part #	Location of Operator	Crank Length	Distance from Floor
39-104-3	Sill	3'	7'
39-527-3	Jamb	3'	7'
39-104-4	Sill	4'	8'
39-527-4	Jamb	4'	8'
39-104-5	Sill	5'	9'
39-527-5	Jamb	5'	9'
39-104-6	Sill	6'	10'
39-527-6	Jamb	6'	10'
39-104-7	Sill	7'	11'
39-527-7	Jamb	7'	11'
39-104-8	Sill	8'	12'
39-527-8	Jamb	8'	12'
39-104-9	Sill	9'	13'
39-527-9	Jamb	9'	13'
39-104-10KD	Sill	10'	14'
39-527-10KD	Jamb	10'	14'
39-104-12KD	Sill	12'	16'
39-527-12KD	Jamb	12'	16'

### Motorized Window Wand Selection Chart



Part #	Location of Operator	Crank Length	Distance from Floor
39-104M-4	Sill	4'	7'
39-527M-4	Jamb	4'	7'
39-104M-5	Sill	5'	8'
39-527M-5	Jamb	5'	8'
39-104M-6	Sill	6'	9'
39-527M-6	Jamb	6'	9'
39-104M-7	Sill	7'	10'
39-527M-7	Jamb	7'	10'
39-104M-8	Sill	8'	11'
39-527M-8	Jamb	8'	11'
39-104M-9	Sill	9'	12'
39-527M-9	Jamb	9'	12'
39-104M-10	Sill	10'	13'
39-527M-10	Jamb	10'	13'

# WINDOW REPLACEMENT HARDWARE

## FACE MOUNTED AWNING OPERATORS

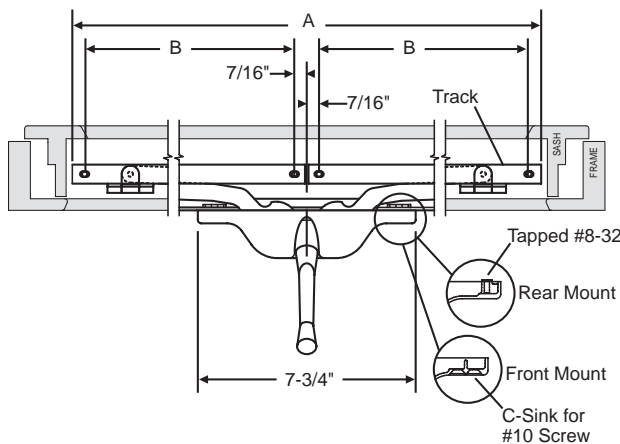

Part #	Arm Length	Overall Length "A" Including Track	Finish	Mounting Style	Track Part #	Track Length "B"
29-129-8	5-1/2"	16-3/4"	Chestnut Bronze	Front	38-66	7-1/2"
29-129-10	5-1/2"	16-3/4"	Black	Front	38-66	7-1/2"
29-129-13	5-1/2"	16-3/4"	Brushed Copper Nickel	Front	38-66	7-1/2"
29-130-3	9"	25-3/4"	White	Front	38-57	12"
29-130-7	9"	25-3/4"	Aluminum	Front	38-57	12"
29-130-8	9"	25-3/4"	Chestnut Bronze	Front	38-57	12"
29-128-1	11"	27-3/4"	Bronze	Front	38-58	13"
29-128-3	11"	27-3/4"	White	Front	38-58	13"
29-128-7	11"	27-3/4"	Aluminum	Front	38-58	13"
29-128-8	11"	27-3/4"	Chestnut Bronze	Front	38-58	13"
29-128-12	11"	27-3/4"	Medium Bronze	Front	38-58	13"
29-128-13	11"	27-3/4"	Brushed Copper Nickel	Front	38-58	13"
29-185-3	11"	27-3/4"	White	Rear	38-58	13"

Pivot Shoe Operator. Designed for Single Vent Awning Windows.

Handle sold separately. See Pages 214 - 218

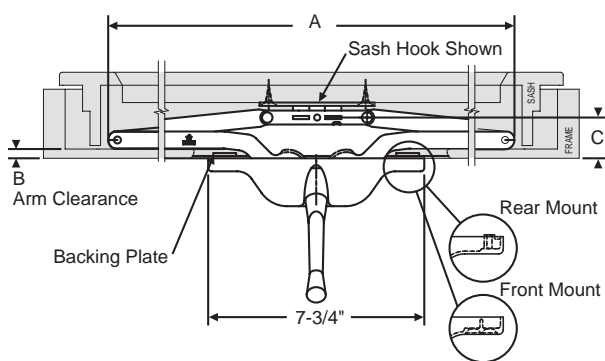

Part #	Overall Width "A"	Arm Clearance "B"	Dimension "C"	Finish	Mounting	Approximate Sash Opening
29-181-1	16"	11/32"	1-1/2"	Bronze	Rear	10"
29-181-3	16"	11/32"	1-1/2"	White	Rear	10"
29-182-3	16"	11/32"	1-1/2"	White	Front	10"
29-177-3	21-1/2"	1/4"	1-3/32"	White	Front	15"
29-199-1	21-1/2"	1/4"	1-3/32"	Bronze	Rear	15"
29-199-3	21-1/2"	1/4"	1-3/32"	White	Rear	15"
29-199-8	21-1/2"	1/4"	1-3/32"	Chestnut Bronze	Rear	15"
29-159-3	21-1/2"	11/32"	1-1/2"	White	Rear	15"
29-159-10	21-1/2"	11/32"	1-1/2"	Black	Rear	15"

Scissors Arm Operator

Handle sold separately. See Pages 214 - 218

# WINDOW REPLACEMENT HARDWARE

## SILL MOUNTED AWNING OPERATORS

### TRUTH'S ENTRYGARD SERIES AWNING OPERATORS

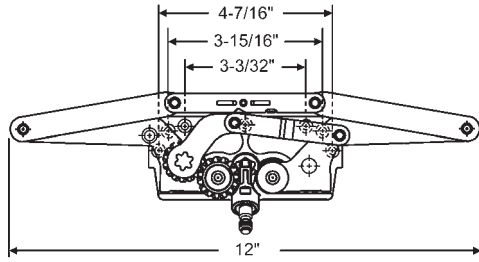

**29-167**

Handle and cover sold separately. See Pages 213 - 218  
Single Pull

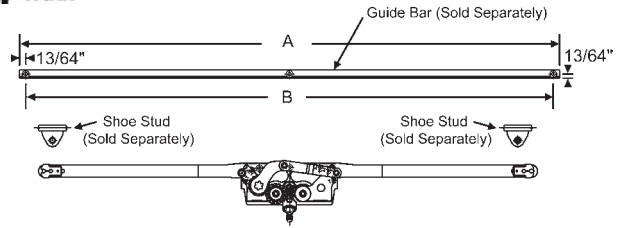

Part #	A	B	Shoe Stud	Guide Bar
29-166	22-3/4"	22-1/8"	39-42	39-320
29-168	30-3/4"	30-1/8"	39-42	39-354

Note: Order Shoe Studs and Guide Bar Separately.  
Handle and cover sold separately. See Pages 213 - 218

### TRUTH'S TRADITIONAL SERIES AWNING OPERATORS

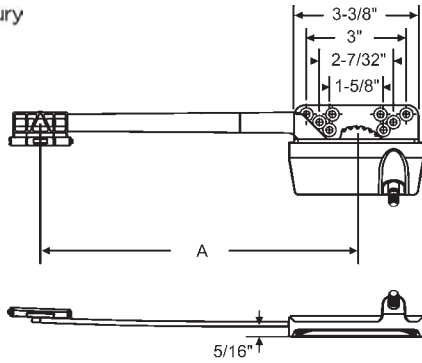

Part #	A
36-301-3	9-1/2"
36-337-3	13-1/2"

Single Arm

Handle sold separately. See Pages 214 - 218

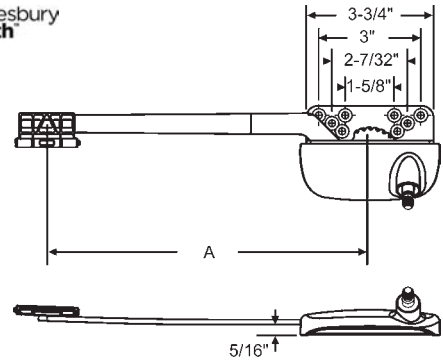

Part #	A
36-301-3E	9-1/2"
36-337-3E	13-1/2"

Single Arm

Handle sold separately. See Pages 214 - 218

### TRUTH'S MAXIM® SERIES AWNING OPERATORS

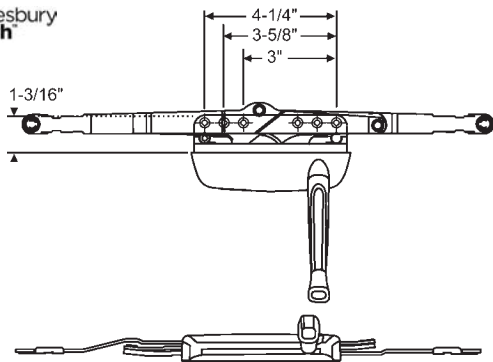

Part #	Finish	Handle Only
29-179-1	Bronze	37-150-1
29-179-3	White	37-150-3
29-179-14	Cocoa	37-150-14

Other Finishes Available.

Handle sold separately. See Pages 214 - 218

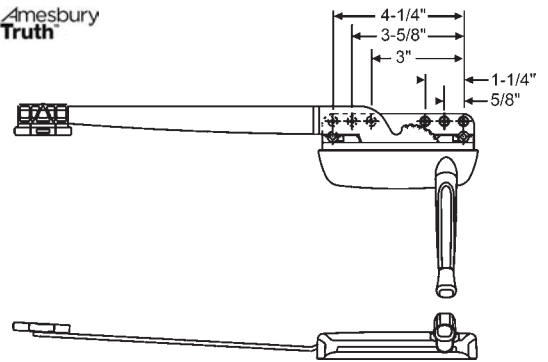

Part #	Finish	Handle Only
29-191-1	Bronze	37-150-1
29-191-3	White	37-150-3

Other Finishes Available

Handle sold separately. See Pages 214 - 218

# WINDOW REPLACEMENT HARDWARE

## SILL MOUNTED AWNING OPERATORS

### TRUTH'S MAXIM® SERIES NARROW AWNING OPERATORS

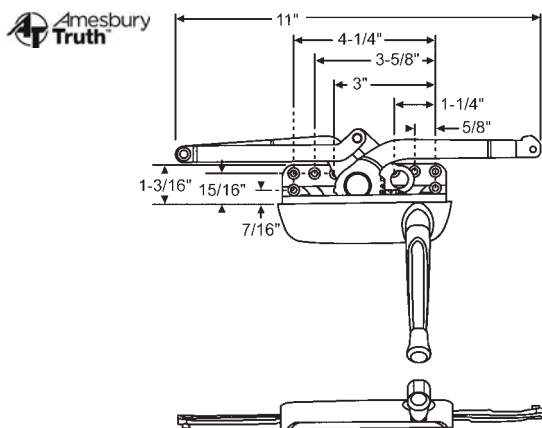

Part #	Finish	Handle Only
29-240-3	White	37-150-3

Other Finishes Available

Handle sold separately. See Pages 214 - 218

### TRUTH'S ENCORE SERIES AWNING OPERATORS

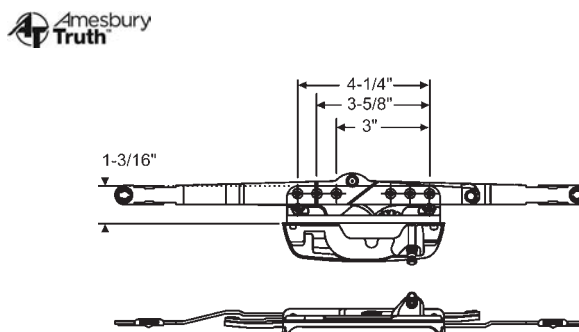

**29-179EN**

Handle and cover sold separately. See Pages 213 - 218

### TRUTH'S ENCORE SERIES NARROW AWNING OPERATORS

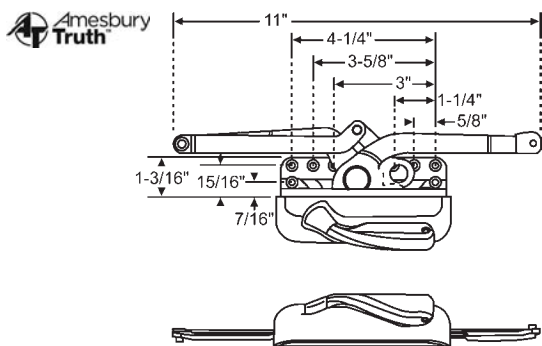

Part #	Description
29-240EN	Steel
29-240ENSS	Stainless Steel

Other Finishes Available

Handle sold separately. See Pages 214 - 218

### TRUTH'S AWNING OPERATORS

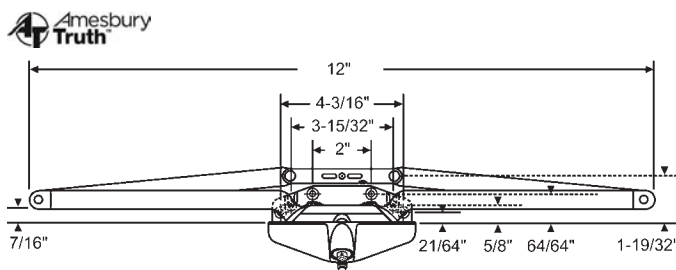

Part #	Finish
29-156-1	Bronze
29-156-3	White

Single Pull.

Handle sold separately. See Pages 214 - 218

### TRUTH'S AWNING OPERATORS

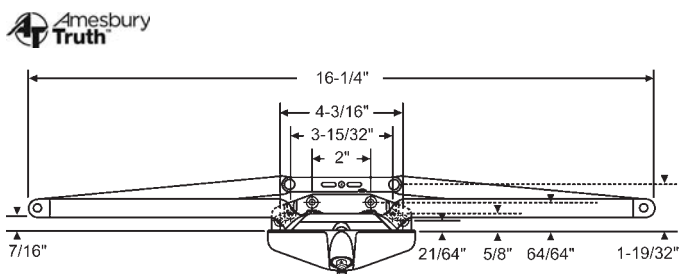

Part #	Finish
29-119-1	Bronze
29-119-3	White
29-119-6	Clay
29-119-9	Beige

Single Pull.

Handle sold separately. See Pages 214 - 218

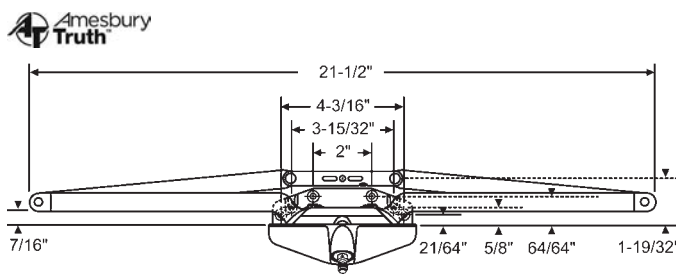

Part #	Finish
29-118-1	Bronze
29-118-3	White
29-118-6	Clay
29-118-8	Chestnut Bronze
29-118-87	Gold
29-118-9	Beige

Single Pull.

Handle sold separately. See Pages 214 - 218

# WINDOW REPLACEMENT HARDWARE

## SILL MOUNTED AWNING OPERATORS

### TRUTH'S AWNING OPERATORS

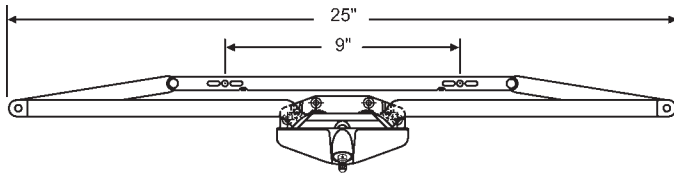

Part #	Finish
29-120-1	Bronze
29-120-2	Gold
29-120-3	White

Dual Pull

Handle sold separately. See Pages 214 - 218  
Other Finishes Available

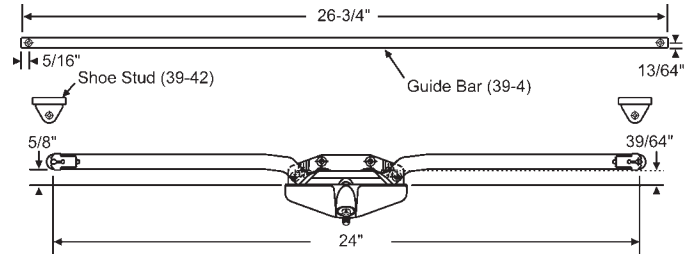

Part #	Finish
29-121-1	Bronze
29-121-2	Gold
29-121-3	White
29-121-10	Black

Note: Must Order Shoe 39-42 Stud and 39-4 Guide Bar Separately  
Handle sold separately. See Pages 214 - 218

### ANDERSEN AWNING OPERATORS

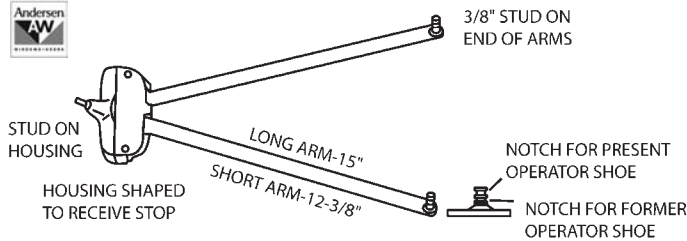

750-0338908

Shoe Sold Separately

Part #	Finish	Arm Length	Handle Only
750-0333808	Bronze	12-3/8"	750-1361358
750-0333908	Bronze	15"	750-1361358

Comes Complete with Handle and Rods

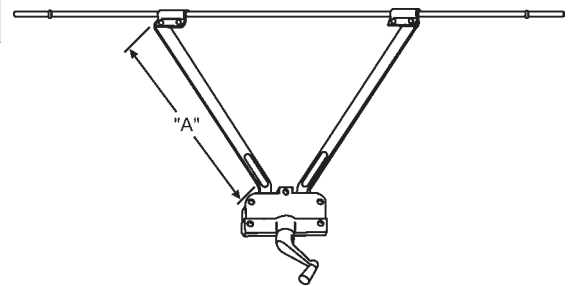

Part #	Finish	A	Handle Only
750-1521604	Stone	11"	750-0532408
750-1521606	Stone	15"	750-0532408

Includes Rods, Brackets and Screws

Handle sold separately. See Pages 214 - 218

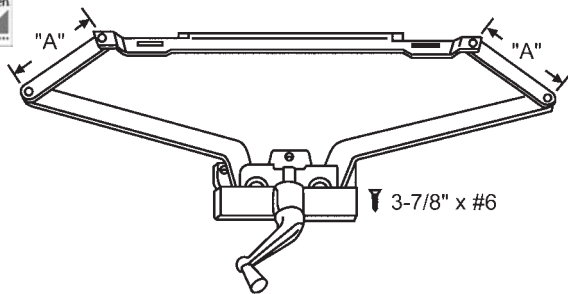

This operator is no longer available.  
Replace with 750-1521608 Operator and use Brackets in  
Place of Existing Track.

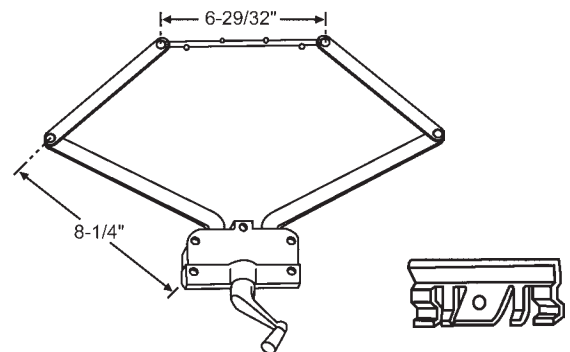

Part #	Finish	Handle Only
750-1521608	Stone	750-0532408

Includes Bracket and Screws.

Handle sold separately. See Pages 214 - 218

# WINDOW REPLACEMENT HARDWARE

## SILL MOUNTED AWNING OPERATORS

### ROTO AWNING OPERATORS

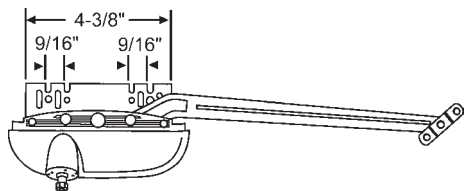

Part #	Finish
36-484AD	Almond
36-484BEW	Blue White
36-484EW	Euro White
36-484W	White

Awning Operator with 10" Arm  
Handle sold separately. See Pages 214 - 218

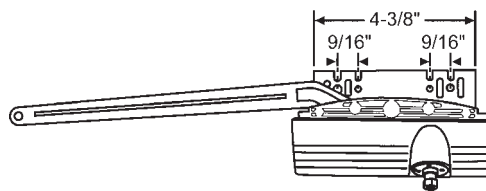

Part #	Finish
29-208BEW	Blue White
29-208BG	Beige

Awning Operator with 10" Arm  
Handle sold separately. See Pages 214 - 218

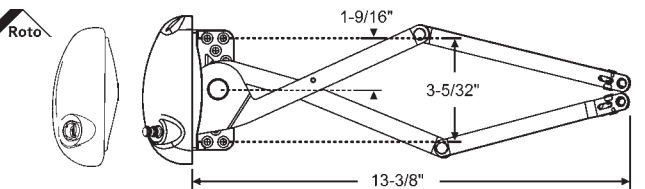

Pro-Drive X-Drive

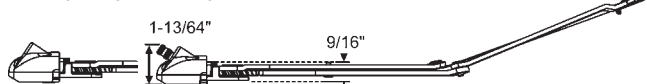

Part #	Finish	Style
29-253W-XD	White	X-Drive
29-253DBR	Dark Brown	Pro-Drive
29-253EB	Earth Brown	Pro-Drive
29-253EW	G1 White	Pro-Drive
29-253AD	Almond	Pro-Drive

For Vinyl Window Application.  
Handle sold separately. See Pages 214 - 218

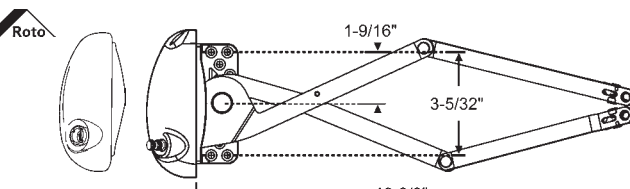

Pro-Drive X-Drive



Part #	Finish	Style
29-254W-XD	White	X-Drive
29-254W	White	Pro-Drive

Notched for Wood Window Application.  
Handle sold separately. See Pages 214 - 218

### MISCELLANEOUS AWNING OPERATOR

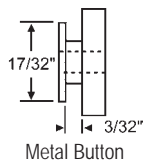
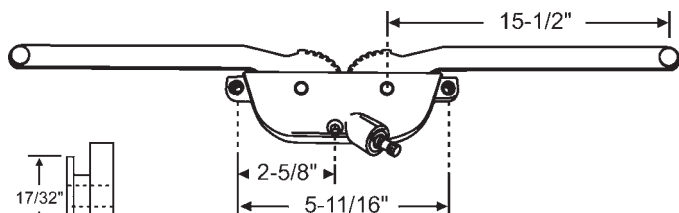

Part #	Finish
29-111	Bronze

Dual Arm Operator for Wood Windows. Handle Included

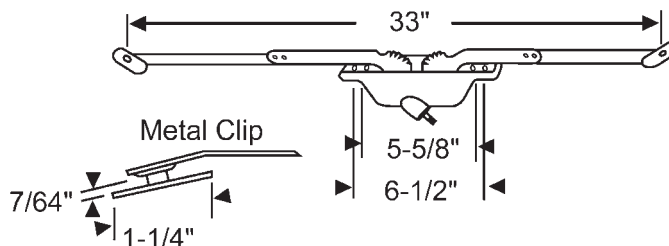

Part #	Finish
29-102	Aluminum

# WINDOW REPLACEMENT HARDWARE

## MILL FINISH AWNING OPERATORS - MIAMI TYPE

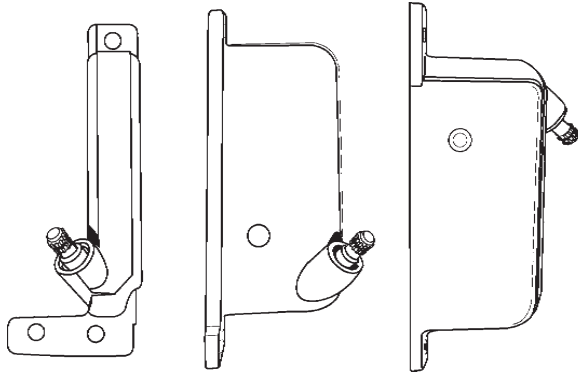
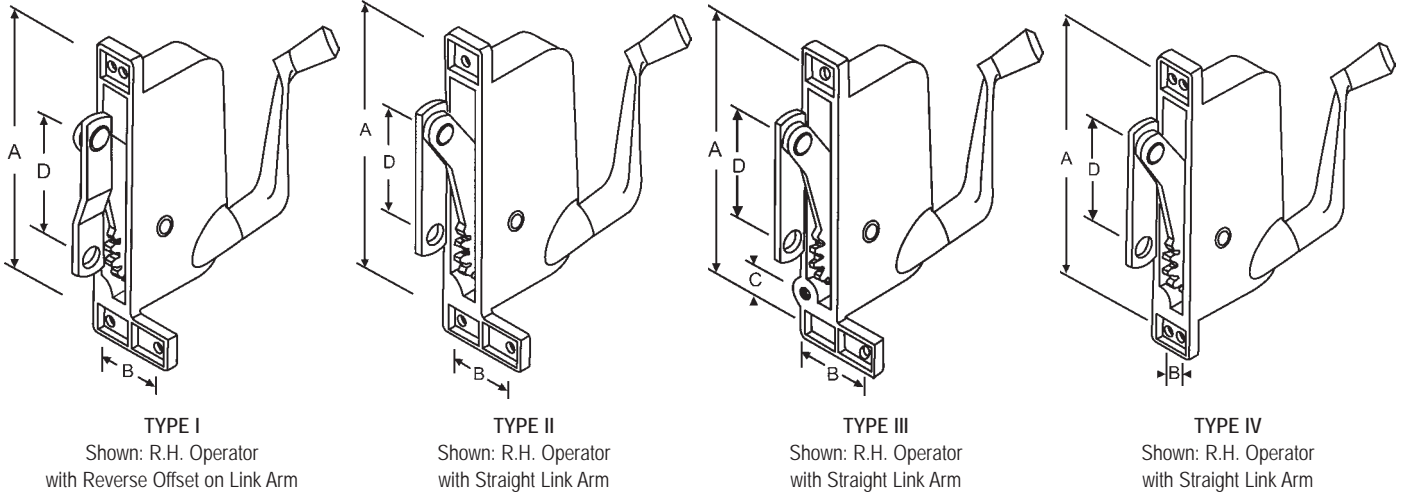

Classic Style Awning Operator - Part Numbers Ending in HD

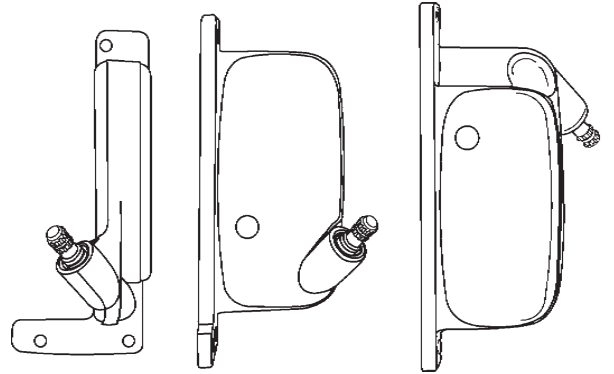

Contemporary Style Awning Operator - Part Numbers Ending in D

RH Part #	LH Part #	Window Name	Housing Type	Dim "A"	Dim "B"	Dim "C"	Dim "D"	Straight/Offset	Link End
41-200P D	41-201P D	Pan American	I	5-1/4"	1-5/16"	N/A	2-5/8"	S	5/16-18 Thread
41-207P D	41-206P D	Stanley	I	5-1/4"	1-3/8"	N/A	2-3/16"	OS	3/8 Hole
41-259P D	41-260P D	Lenahan	I	5-1/4"	13/16"	N/A	2-11/16"	S	3/8 Hole
41-271P HD	41-270P HD	Yale - Ogron	I	5-1/4"	7/8"	N/A	2-3/16"	S	3/8 Hole
41-296P D	41-295P D	Ware	I	5-1/4"	7/8"	N/A	2-3/16"	OS	3/8 Hole
41-205P D*	41-204P D*	Keller - Air Control - PGT	II	5-1/4"	1-1/8"	N/A	2-5/16"	S	1/4-20 Thread
41-214P D	41-215P D	ABC	II	5-1/4"	1-1/4"	N/A	2-7/16"	S	3/8 Hole
41-230P D*	41-231P D*	Look - Rusco	II	5-1/4"	1-3/8"	N/A	2-7/16"	S	1/4-20 Thread
41-257P D*	41-258P D*	Tucker	II	5-1/4"	1-1/4"	N/A	2-3/8"	S	10-24 Thread Bushing
41-263P D	41-264P D	Nu-Aire	II	5-1/8"	15/16"	N/A	2-5/8"	S	3/8 Hole
41-395P D	41-396P D	Stanley - CE	II	5-1/4"	1-3/8"	N/A	2-3/16"	OS	3/8 Hole
41-636P D	41-637P D	Remington - Silverline	II	5-1/4"	1-1/8"	N/A	2-7/16"	S	10-24 Thread Bushing
41-211P D	41-210P D	Miami	III	5-1/8"	1-1/2"	1/2"	2"	OS	5/16-18 Thread
41-212P D	41-213P D	ABC	III	5-1/16"	1-7/16"	1/2"	2-3/16"	S	1/4 E-Ring Stud
41-232P HD	41-233P HD	Superior	III	5-1/16"	1-7/16"	1/2"	2-1/8"	S	5/16-18 Thread
41-234P D	41-235P D	Crown	III	5-1/6"	1-7/16"	1/2"	2-1/4"	S	3/8 Hole
41-236P D*	41-237P D*	Tucker	III	5-1/16"	1-7/16"	1/2"	2-1/2"	S	10-24 Thread Bushing
41-388P D	41-387P D	Harcar	III	5-1/16"	1-7/16"	1/2"	2-7/16"	OS	5/16-18 Thread
41-457P D	41-455P D	VE Andersen	III	5-1/16"	1-7/16"	1/2"	2-1/2"	OS	3/8 Hole
41-223P D*	41-224P D*	Look - Rusco	IV	5-1/4"	7/16"	N/A	2-1/8"	S	5/16-18 Thread

For Additional Sizes and Colors Contact Your Account Manager. Items Above also Available Carded

\* Top hole is offset, not centered.

# WINDOW REPLACEMENT HARDWARE

## JALOUSIE OPERATORS

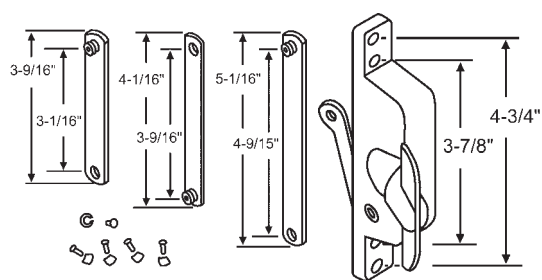

Part #	Finish
41J-4000PK	Aluminum
41J-4000PKW	White

Universal Jalousie Operator Kit

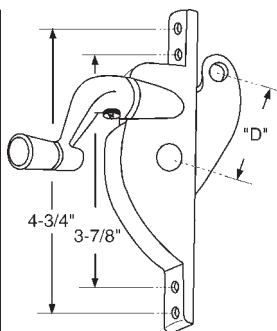

Part #	Packaging	Finish	Hand	Link	"D"
41J-208P	Bagged	Aluminum	Shown		1-1/2"
41J-209P	Bagged	Aluminum	Opposite		1-1/2"
41J-242P	Bagged	Aluminum	Opposite		2"
41J-243P	Bagged	Aluminum	Shown		2"
41J-809P	Bagged	Aluminum	Opposite		1-1/4"
41J-810P	Bagged	Aluminum	Shown		1-1/4"
41J-882P	Bagged	Aluminum	Shown	3" Link	1-1/2"
41J-883P	Bagged	Aluminum	Opposite	3" Link	1-1/2"

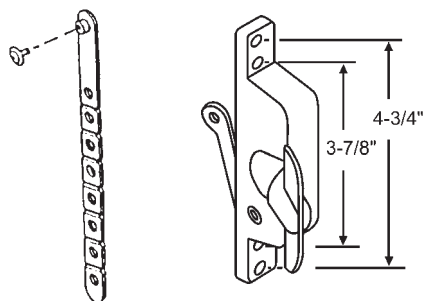

Part #	Finish
29-160	Aluminum
29-161	Bronze

Break-Away Operator Kit, Includes Screws

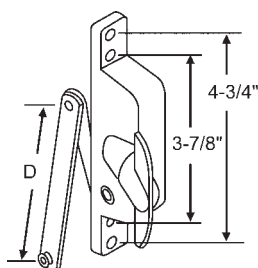

Part #	Packaging	Finish	Description	"D"
41J-300P	Bagged	Aluminum	Air Control	3-1/32"
41J-300PB	Bagged	Bronze	Air Control	3-1/32"
41J-300PW	Bagged	White	Air Control	3-1/32"
41J-301P	Bagged	Aluminum	Stanley	3-11/32"
41J-302P	Bagged	Aluminum	ABC	1-23/32"
41J-303P	Bagged	Aluminum	Pan Am	3-5/8"
41J-303PB	Bagged	Bronze	Pan Am	3-5/8"
41J-303PW	Bagged	White	Pan Am	3-5/8"
41J-441P	Bagged	Aluminum	Look	3-5/8"
41J-464P	Bagged	Aluminum	Superior	4"
41J-464PB	Bagged	Bronze	Superior	4"
41J-464PW	Bagged	White	Superior	4"
41J-1421P	Bagged	Aluminum	Crown	4-1/2"
41J-3338P	Bagged	Aluminum	Nu Air	4-1/4"

## AWNING AND JALOUSIE ACCESSORIES

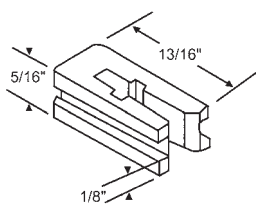

**33-138**

Awning Window Guide  
Nylon

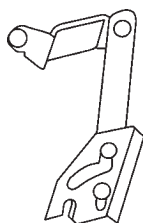

**28-91**

Awning Vent Hinge  
Assemblies (Pair)  
**BINNINGS PAN AM**

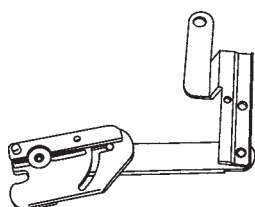

**900-9732**

Vent Hinge (Pair)  
**ANDERSON**

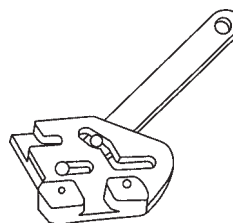

**900-236**

Harcar Lock Assembly (Pair)  
**HARCAR**

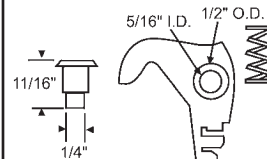

**900-7949**

Bottom Nylon Vent Hook Set  
(2 Guides, 2 Rivets, 2 Springs)

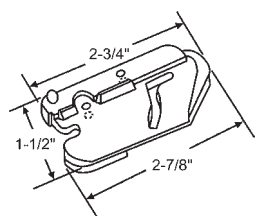

**33-142**

Vent Lock - Pair

**ANDERSON**

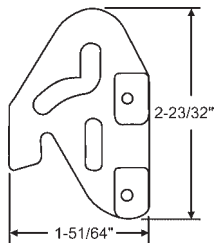

**33-123**

Black Nylon Cam Lock  
with Rivets

**HARCAR**

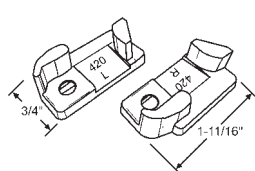

**900-299**

Black Plastic Awning Window  
Vent Lock Set (RH/LH)

**STANLEY**

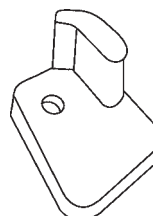

**900-300**

Top Vent Lock (Pair)

**STANLEY**

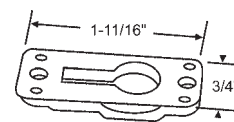

**900-301**

Control Bracket  
Use with 900-301C Cam

**STANLEY**



# WINDOW REPLACEMENT HARDWARE

## AWNING AND JALOUSIE ACCESSORIES

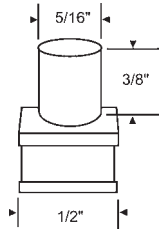

**900-304**  
Locking Pin

**AIR CONTROL**

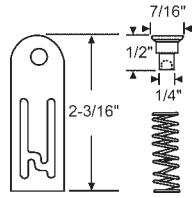

**900-9874**  
Locking Spring/Guide Set

**CROSSLY**

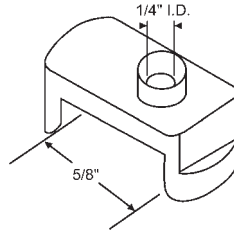

**33-124**  
Draw Bar Bearing

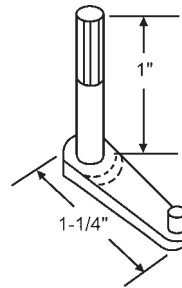

**33-134**  
Cline Link

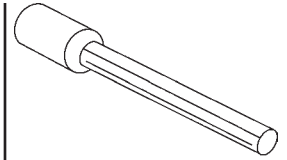

Part #	Color
33-122AL	Aluminum
33-122BZ	Bronze
33-122W	White

6" Standard Length Cut to Size in Field. Male 5/16" Hex to 3/8" Female Spline.

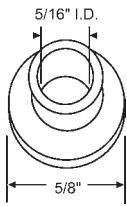

**900-20934**  
Nylon Bushing

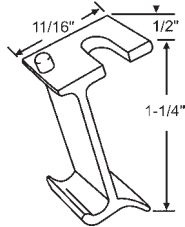

**900-10447**  
Sliding Window Pivot Bracket  
**ACORN**

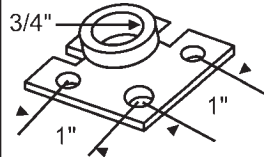

**526P**  
Torque Bar Bearing  
**LUDMAN**

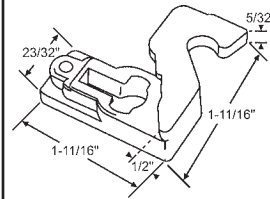

**33-126**  
Vent Lock

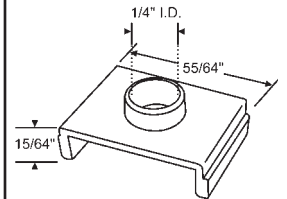

**33-129**  
Slide Bar Guide  
Plastic  
**AIR CONTROL**

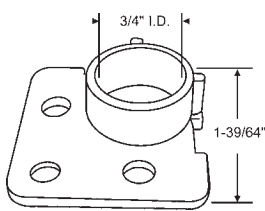

**900-259**  
Torque Bar Bearing  
Plastic  
**MIAMI**

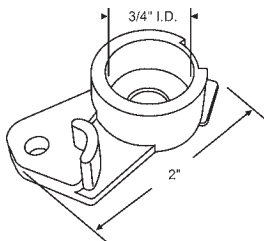

**900-279**  
Torque Bar Bearings (Pair)  
Plastic  
**STANLEY**

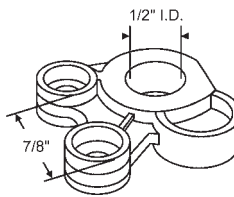

**900-275**  
Torque Shaft Bearing  
**CROSSLY**

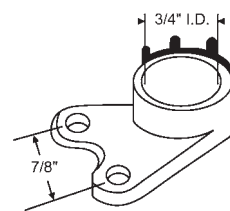

**900-282**  
RH/LH Torque Bar Bearings (Set)

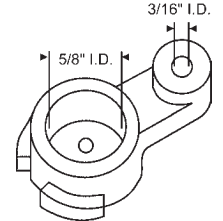

**33-125**  
Torque Bar Bearing

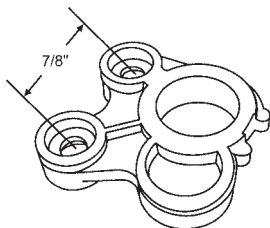

**900-274**  
Torque Shaft Bearing

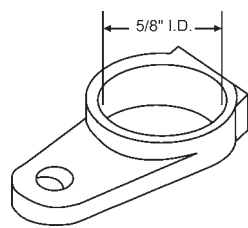

**900-6903**  
Torque Bar Bearing

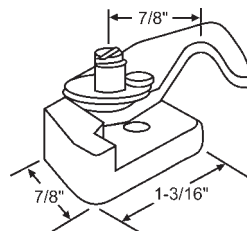

**33-107**  
Block Hook Assembly  
Nylon Base with Aluminum Hook  
Sold in Sets Only  
**KELLER**

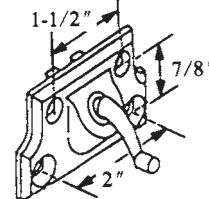

**900-7349**  
Center Operator with Handle  
100 Series  
**UALCO**

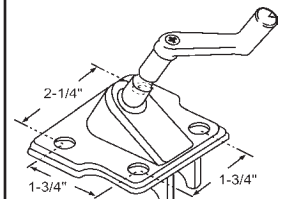

**900-7967**  
Center Operator with Handle  
200 Series  
**UALCO**

# WINDOW REPLACEMENT HARDWARE

## AWNING AND JALOUSIE ACCESSORIES

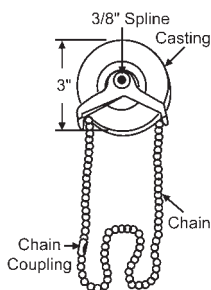

Part #	Description
33-146	Chain Wheel Only
33-135	#13 Large Chain
33-136	Chain Coupling

#13 chain sold by the foot. All items need to be ordered separately

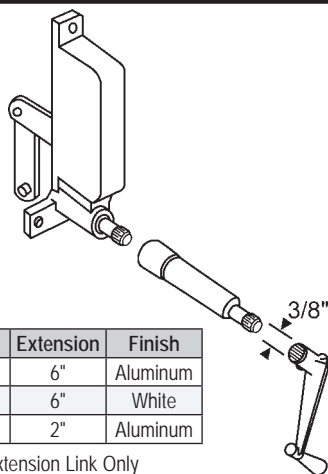

Part #	Extension	Finish
37-161-6AL	6"	Aluminum
37-161-6W	6"	White
37-161-2AL	2"	Aluminum

ATW Extension Link Only  
Male to Female 3/8" Spline.

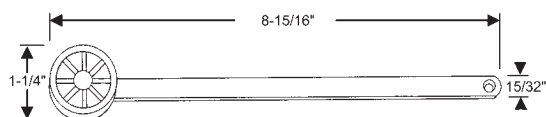

**900-20144**  
Basement Hopper Roller Guide

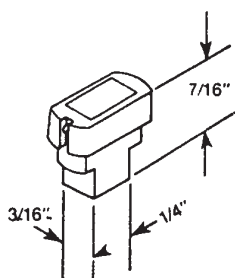

**33-112**  
Die Cast Balance Arm Button

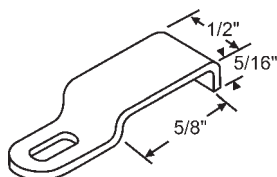

Part #	Finish
33-101W	White
33-101BZ	Bronze

**KELLER**

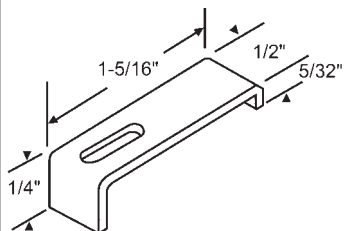

**33-100W**  
White Panel Clip

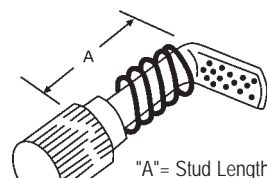

Part #	"A"
33-105	7/8"
900-12157	1"
900-12158	3/4"

Panel Screw. Aluminum

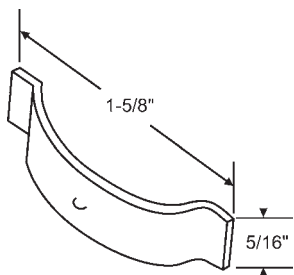

**900-16054**  
Stamped Steel Spring Clip  
**CLEARVIEW**

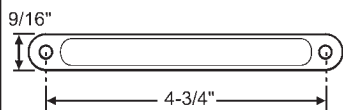

Part #	Finish
900-15138	Aluminum
900-15138BZ	Bronze
900-15138W	White

Cover Plate  
**PAN AM**

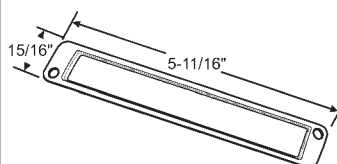

Part #	Finish
33-128	Mill
33-128W	White
33-128BZ	Bronze

Cover Plate. Offset Hole

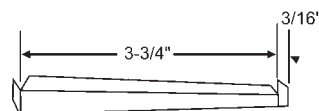

**900-15108**  
Jalousie Wedge.  
Sold in Pairs Only (RH& LH)  
**ARNOLD ALTEX**

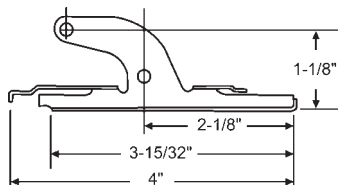

Part #	Finish
900-7713	Aluminum

Sold in Sets Only (1 Right & 1 Left Clip)

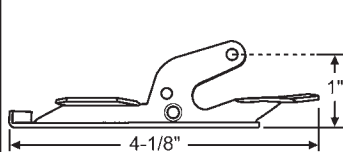

**33-180**  
Aluminum. Sold in Pairs  
**AIR MASTER**

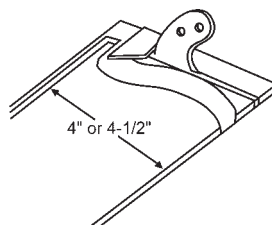

Part #	Glass Size	Length
33-111-4	4"	3-1/16"
33-111-4 1/2	4-1/2"	3-3/8"

Security Clips. Stainless Steel Clips Apply Pressure and Prevent Glass Removal from Outside. One Clip Under Each End Bracket Affords Extra Security.

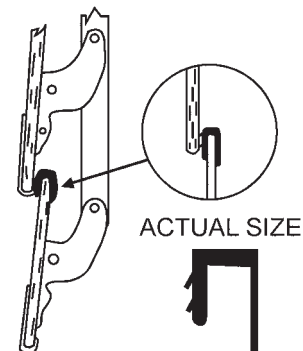

**33-106**  
Jalousie Seal. 36' per Bag.  
Seals Out The Drafts

### Typical Torque Bar Assembly

Many Types in Stock  
Minimum Order Required  
for Non-Stocked Items

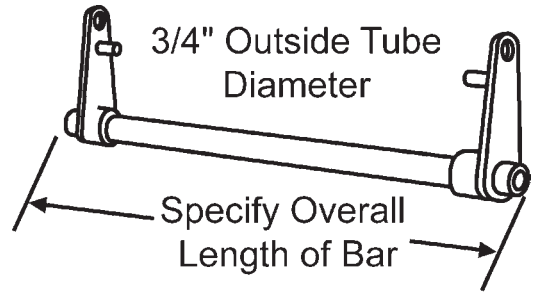

Part #	Manufacturer
33-113	Yale Ogron
33-151	Superior/Miami
33-152	Airelok
33-153	Old Tropical
33-154	Stanley 45
33-155	Pan Am/Daryl
33-156	ABC
33-157	Old Air Control
33-158	Anderson

Part #	Manufacturer
33-159	Keller/Air Control
33-160	Old Ware
33-161	Miami Highlander
33-162	Wallace
33-163	Stanley
33-164	Ludman
33-165	Old Crossly
33-166	Old Tucker
33-178	Security
33-183	Stanley Narrow Vent

#### Ordering Instructions

1. Identify manufacturers name of torque bar arms from drawings below
2. Match manufactures name from torque bar assembly chart and choose part number.
3. Measure length of bar including torque bar arms.
4. To create part number, combine #2 and #3.

#### Example

- Torque bar arm matches manufacturer Yale Ogron
- Yale Ogron matches torque bar assembly Part Number 33-113
- Length of bar including torque bar arms is 25-1/2"
- Order part number 33-113-25-1/2

Ordering Instructions: Identify manufacturer, then specify overall length, including torque bar arm.







### TORQUE BAR ARMS

(Available Separately)

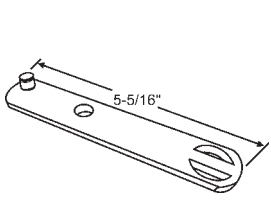
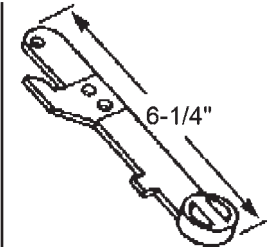
<p>4-15/16"</p> <p><b>900-12807</b> <b>YALE OGRON</b></p>	<p>5-7/8"</p> <p><b>33-167</b> <b>SUPERIOR/MIAMI</b></p>	<p>7/8" 4-1/2"</p> <p><b>33-168</b> <b>AIRELOK</b></p>	<p>6"</p> <p><b>33-169</b> <b>OLD TROPICAL</b></p>	<p>4-1/4"</p> <p><b>33-133</b> <b>PAN AM/DARYL</b></p>	<p>4-3/4"</p> <p><b>900-21437</b> <b>ABC</b></p>
<p>1-1/2" 4-3/4"</p> <p><b>900-8283</b> <b>OLD AIR CONTROL</b></p>	<p>1" 5"</p> <p><b>900-22269</b> <b>ANDERSON</b></p>	<p>4-3/4"</p> <p><b>900-11364</b> <b>KELLER/AIR CONTROL</b></p>	<p>4-7/8"</p> <p><b>33-172</b> <b>OLD WARE</b></p>	<p>4-9/16"</p> <p><b>33-173</b> <b>MIAMI/HIGHLANDER</b></p>	<p>4-1/4"</p> <p><b>33-174</b> <b>WALLACE</b></p>
<p>5-1/4"</p> <p><b>900-331</b> <b>STANLEY</b></p>	<p>7-1/2"</p> <p><b>33-175</b> <b>LUDMAN</b></p>	<p>5-3/4"</p> <p><b>33-176</b> <b>OLD CROSSLY</b></p>	<p>4-3/4"</p> <p><b>33-177</b> <b>OLD TUCKER</b></p>	<p>4-1/4"</p> <p><b>33-179</b> <b>SECURITY</b></p>	<p>3-7/8"</p> <p><b>547P</b> Die Cast <b>ARNOLD/ALTEX</b></p>

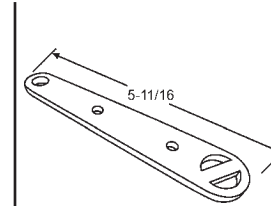
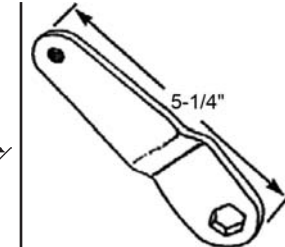
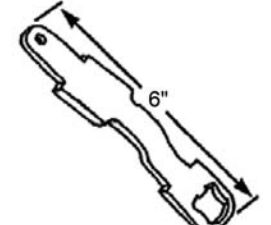
# WINDOW REPLACEMENT HARDWARE

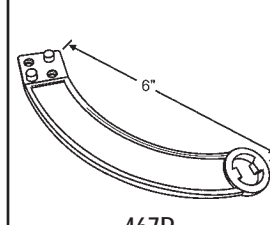
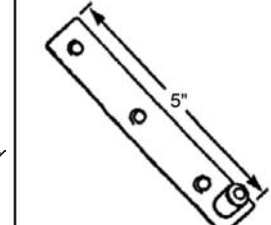
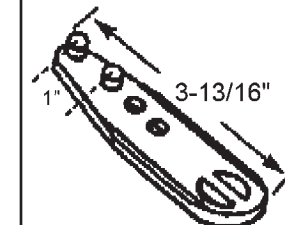
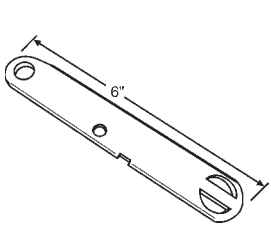
## TORQUE BAR ARMS

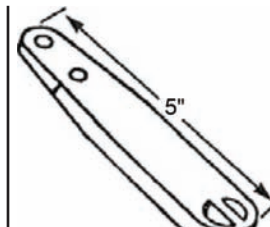
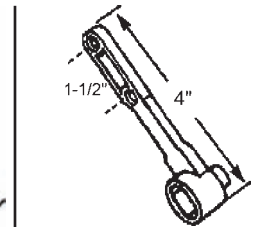
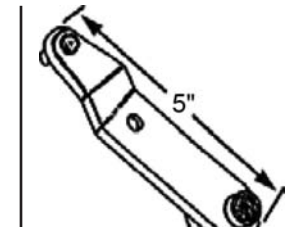
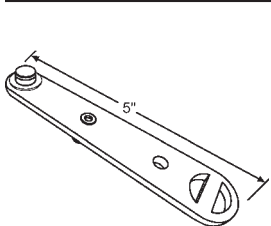
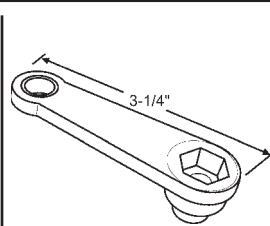
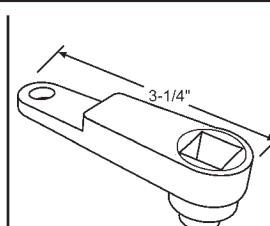
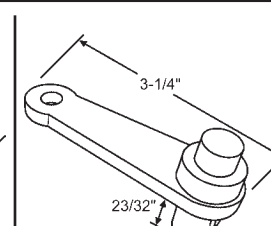
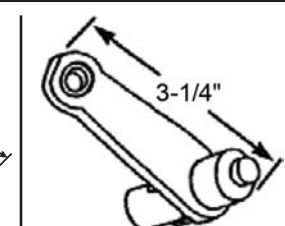
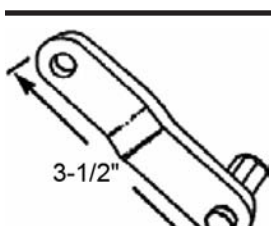
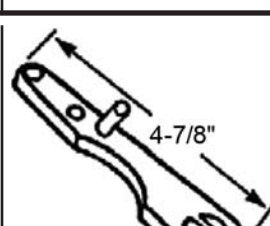
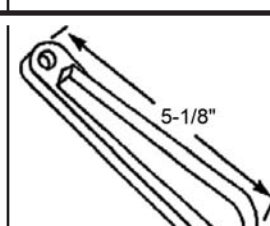
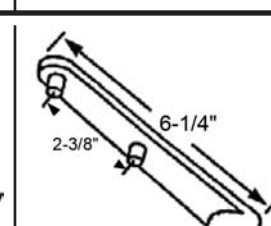
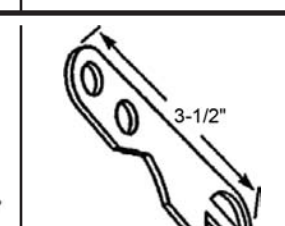
 <p>5-5/16"</p> <p><b>640P</b> Pair <b>DURAL</b></p>	 <p>6-1/4"</p> <p><b>900-9997</b> Pair <b>UALCO SERIES 300</b></p>	 <p>6-1/4"</p> <p><b>900-7660</b> Pair <b>UALCO SERIES 200</b></p>	 <p>5-11/16"</p> <p><b>644P</b> <b>UNIVERSAL</b></p>	 <p>5-1/4"</p> <p><b>AWT 8</b> <b>UNIVERSAL</b></p>
 <p>6"</p> <p><b>AWT 10</b></p>	 <p>4-7/8"</p> <p><b>105P</b> <b>LOOK</b></p>	 <p>6"</p> <p><b>467P</b> Pair <b>MIAMI</b> <b>RADIAL ARM</b></p>	 <p>5"</p> <p><b>AWT 18</b></p>	 <p>3-13/16"</p> <p>1"</p> <p><b>638P</b> <b>STANLEY</b> <b>NARROW VENT</b></p>
 <p>6"</p> <p><b>439P</b> <b>PALM BEACH</b></p>	 <p>5-5/8"</p> <p><b>AWT 27</b> <b>CROWN</b></p>	 <p>5"</p> <p><b>150P</b> <b>HAR CAR</b></p>	 <p>1-1/2"</p> <p>4"</p> <p><b>900-8284</b> Die Cast <b>AIR CONTROL</b> <b>OLD SLOT</b></p>	 <p>5"</p> <p><b>900-21137</b> <b>VE ANDERSON</b> <b>MODEL 405</b></p>
 <p>5"</p> <p><b>900-21435</b> <b>NU-AIRE</b></p>	 <p>3-1/4"</p> <p><b>900-21003H</b> <b>GENERAL</b> <b>HEX</b></p>	 <p>3-1/4"</p> <p><b>900-21003</b> <b>SQUARE</b></p>	 <p>3-1/4"</p> <p>23/32"</p> <p><b>900-21433</b> <b>GENERAL</b> <b>ROUND</b></p>	 <p>3-1/4"</p> <p>23/32"</p> <p><b>AWT 43</b> <b>GENERAL</b> <b>LONG ROUND</b></p>
 <p>3-1/2"</p> <p><b>AWT 44</b> Die Cast <b>OLD LEONARD</b></p>	 <p>4-7/8"</p> <p><b>AWT 47</b> Pair <b>NEW LOOK</b></p>	 <p>5-1/8"</p> <p><b>AWT 50</b> <b>ORIGINAL</b> <b>AWN-WIN</b></p>	 <p>6-1/4"</p> <p>2-3/8"</p> <p><b>AWT 51</b> <b>WINDOW</b> <b>MASTER</b></p>	 <p>3-1/2"</p> <p><b>AWT 52</b> No Longer Available <b>KELLER '90</b></p>

# WINDOW REPLACEMENT HARDWARE

## TORQUE BAR ARMS

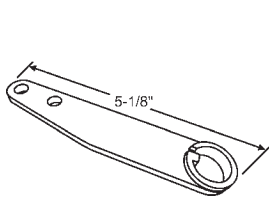

**142P**  
**ARNOLD**  
**ALTEX**



**AWT 56**

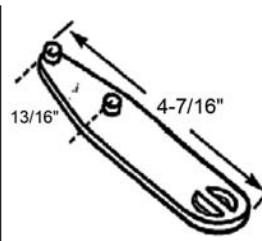

**AWT 61**  
**WILLIAMS**

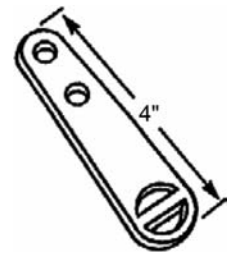

**AWT 64**  
**AIR MASTER**

## CASEMENT AND AWNING OPERATOR BRACKETS

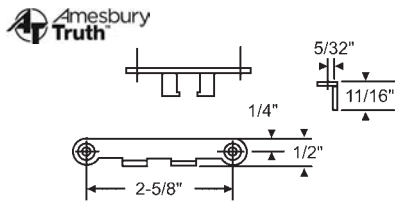

Part #	Description
39-364	E-Gard Finish

Sash Hook

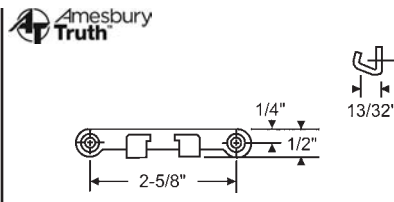

Part #	Description
39-1	E-Gard Finish
39-1CG	Coast-Gard Finish

Sash Hook for Lever Operator

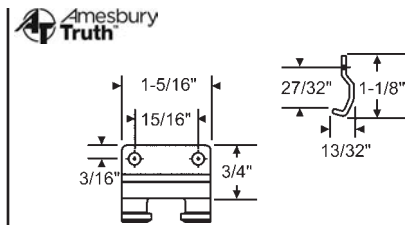

**39-241**

Center Hook for Lever Operator

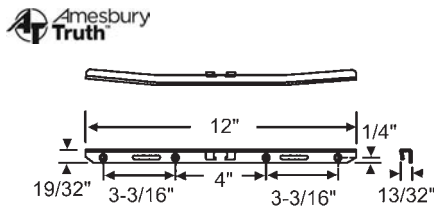

Part #	Description
39-2	E-Gard Finish
39-2CG	Coast-Gard Finish

Torsion Bar for Lever Operator

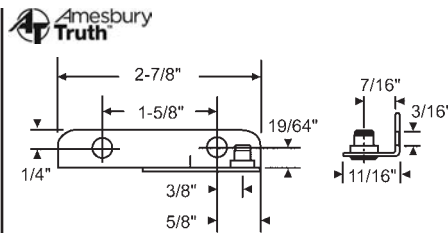

Part #	Hand
39-409	Shown
39-410	Opposite

Dual Arm Operator Bracket. E-Gard Finish

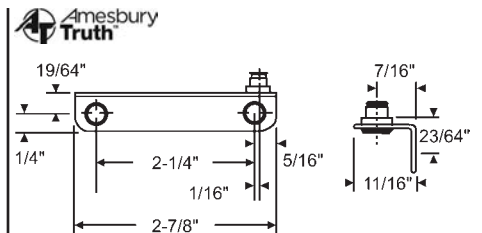

Part #	Hand
39-411	Shown
39-412	Opposite

Dual Arm Operator Bracket. E-Gard Finish

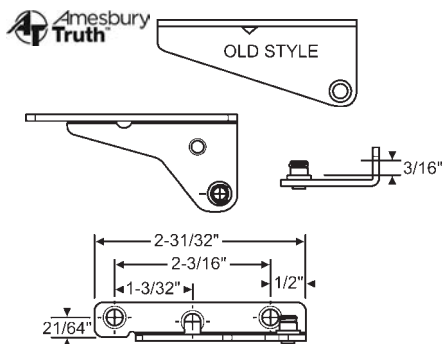

Part #	Hand
39-299	Shown
39-298	Opposite
39-299CG (Coast-Gard)	Shown
39-298CG (Coast-Gard)	Opposite

Clip-on Type

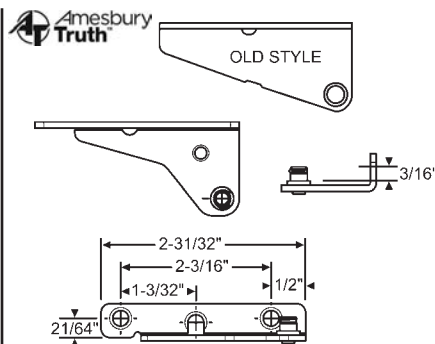

Part #	Hand
39-21	Shown
39-21SS (Stainless Steel)	Shown
39-22	Opposite
39-22SS (Stainless Steel)	Opposite

Snap-on Type

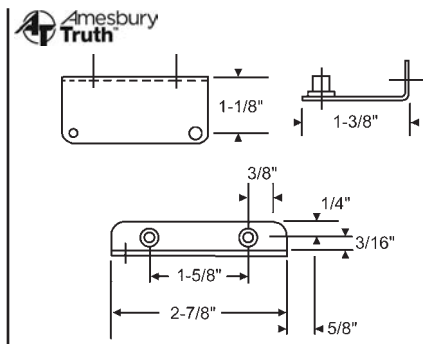

Part #	Hand
39-9 (E-Gard)	Shown
39-10 (E-Gard)	Opposite
39-9CG (Coast-Gard)	Shown
39-10CG (Coast-Gard)	Opposite

Stud Bracket

# WINDOW REPLACEMENT HARDWARE

## CASEMENT AND AWNING OPERATOR BRACKETS

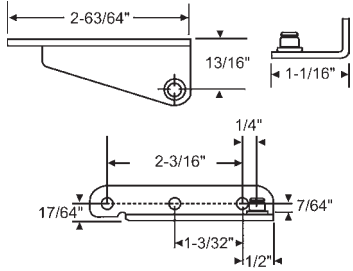

Part #	Hand	Clip Type
39-534 (E-Gard)	Shown	Snap Stud
39-535 (E-Gard)	Opposite	Snap Stud
39-534CG (Coast-Gard)	Shown	Snap Stud
39-535CG (Coast-Gard)	Opposite	Snap Stud

Stud Bracket

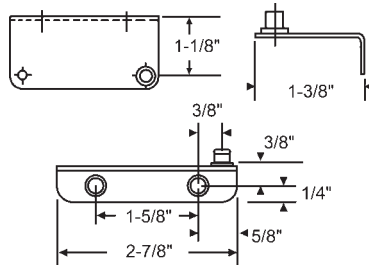

Part #	Hand
39-65	Shown
39-66	Opposite

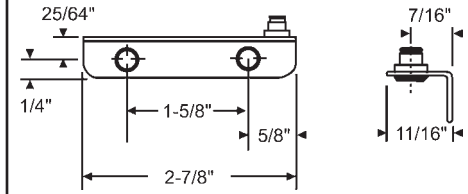

Part #	Hand
39-5	Shown
39-6	Opposite
39-5SS (Stainless Steel)	Shown
39-6SS (Stainless Steel)	Opposite

Stud Bracket

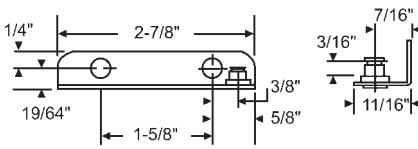

Part #	Hand
39-7	Shown
39-8	Opposite

Stud Bracket

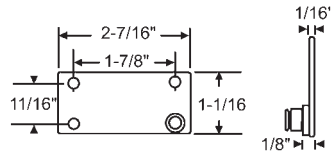

Part #	Hand
39-50	Shown
39-51	Opposite

Stud Bracket

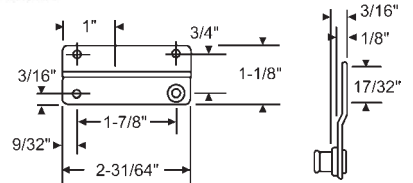

Part #	Hand
39-52	Shown
39-53	Opposite

Stud Bracket

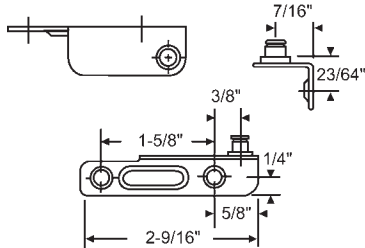

Part #	Hand
39-15	Shown
39-16	Opposite

Stud Bracket

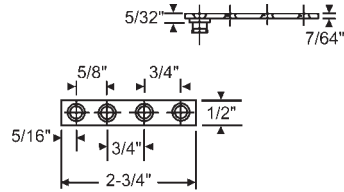

Part #	Material
39-64	E-Gard
39-64CG	Coast-Gard

Non-Hand with Snap Stud

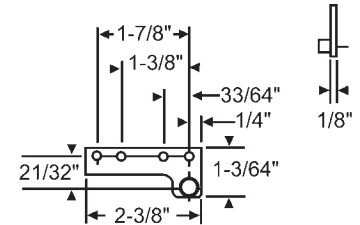

Part #	Hand
39-569	Shown
39-570	Opposite

Stud Bracket

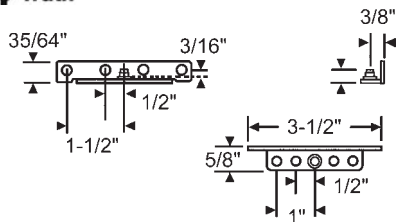

**39-418**  
Non-Hand Snap Stud Bracket

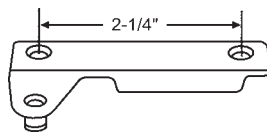

Part #	Hand
750-1361208	Shown
750-1361210	Opposite

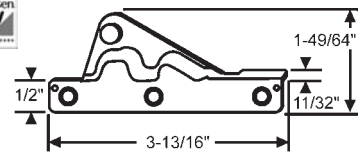

Part #	Hand	Type
750-1361409	Shown	Standard
750-1361408	Opposite	Standard
750-1361411	Shown	Corrosion Resistant
750-1361410	Opposite	Corrosion Resistant

Sash Bracket for 750-1361484

# WINDOW REPLACEMENT HARDWARE

## CASEMENT AND AWNING OPERATOR BRACKETS

**Roto**

Part #	Hand
39-737LH	Shown
39-737RH	Opposite

Sash Bracket

**Roto**

Part #	Hand
39-698	Shown
39-699	Opposite

Sash Bracket Assembly. 35mm, Face Mount

**Roto**

Part #	Hand
39-700	Shown
39-701	Opposite

Sash Bracket Assembly. 30mm, Face Mount

**SHLAND HARDWARE SYSTEMS**

Part #	Hand
39-900LH	Shown
39-900RH	Opposite

Bracket

### OPERATOR COVERS

#### MAXIM® OPERATOR COVER

Plastic Nesting Cover for Maxim® Operators

Converts Crank Handle to Folding Handle. Just Snap on Top of Operator.

Part #	Hand	Finish
36-368NCV-1	Shown	Bronze
36-369NCV-1	Opposite	Bronze
36-368NCV-3	Shown	White
36-369NCV-3	Opposite	White

Furnished with Double Sided Tape Pre-Applied to Cover for Attaching Cover to Maxim® Operator

#### TRUTH'S ENCORE™ TANGO FOLDING HANDLE & COVER

**Amesbury Truth**

Part #	Hand	Finish
37-215-1	Shown	Bronze
37-216-1	Opposite	Bronze
37-215-3	Shown	White
37-216-3	Opposite	White
37-215-71	Shown	Oil Rubbed Bronze

#### ENTRYGARD FOLDING HANDLE & COVER

**Amesbury Truth**

Converts Crank Handle to a Folding Handle. Just Remove Handle & Cover, and Install over Operator.

Part #	Finish
37-220-3	White
37-220-1	Bronze

Folding Handle System. Other Finishes Available

**Amesbury Truth**

Part #	Hand	Finish
37-237LH-3	Shown	White

Plastic Nesting Cover and Folding Handle. Fits all Truth Series 15 & Ellipse

**Amesbury Truth**

Part #	Finish
36-173CV-1	Bronze
36-173CV-2	Gold
36-173CV-3	White
36-173CV-5	Brass
36-173CV-6	Clay
36-173CV-8	Chestnut Bronze
36-173CV-9	Beige
36-173CV-14	Cocoa Brown
36-173CV-15	Off-White
36-173CV-29	Bright White

Plastic

**Amesbury Truth**

Part #	Finish
36-173MC-1	Bronze
36-173MC-3	White
36-173MC-38	Tuscan Bronze
36-173MC-71	Oil Rubbed Bronze

Metal

**Amesbury Truth**

Part #	Finish
36-173PCV-1	Bronze
36-173PCV-2	Gold
36-173PCV-3	White

Plastic Contour Cover

# WINDOW REPLACEMENT HARDWARE

## OPERATOR COVERS

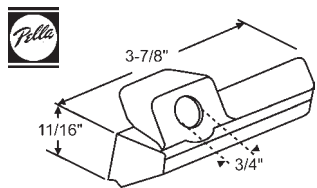

Part #	Hand	Finish
36-201LH	Shown	Copperite
36-201RH	Opposite	Copperite
36-201LHW	Shown	White
36-201RHW	Opposite	White
36-201LHCHP	Shown	Champagne
36-201RHCHP	Opposite	Champagne

Square Cover

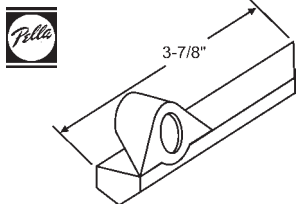

Part #	Hand	Finish
36-202LHW	Shown	White
36-202RHW	Opposite	White
36-202LHCHP	Shown	Champagne
36-202RHCHP	Opposite	Champagne
36-202LHBP	Shown	Bright Brass Plated
36-202RHBP	Opposite	Bright Brass Plated

Round Cover

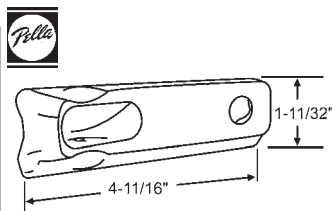

Part #	Hand	Finish
36-219RHCHP	Shown	Champagne
36-219LHCHP	Opposite	Champagne
36-219RHBP	Shown	Bright Brass Plated
36-219LHBP	Opposite	Bright Brass Plated
36-219RHW	Shown	White
36-219LHW	Opposite	White

Integrated Folding Handle Cover

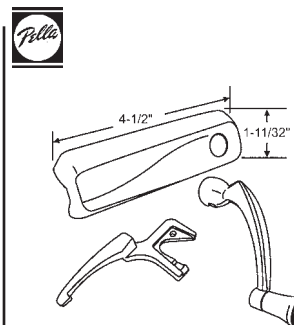

Part #	Hand	Finish
36-505LHCHP	Shown	Champagne
36-505RHCHP	Opposite	Champagne
36-505LHW	Shown	White
36-505RHW	Opposite	White

Crank Kit

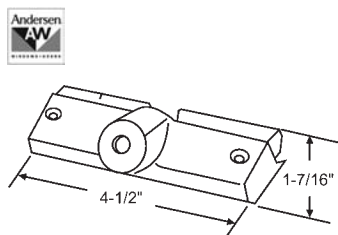

Part #	Finish
750-0532610	Stone
750-1351330	White

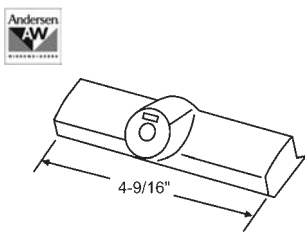

Part #	Finish
750-0532608	Stone

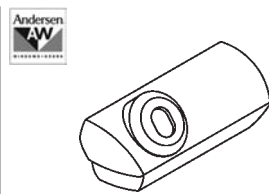

Part #	Finish
750-1361530	Stone
750-1361529	White

Classic Style



Part #	Finish
750-1361531	Stone
750-1361532	White

Metro Style

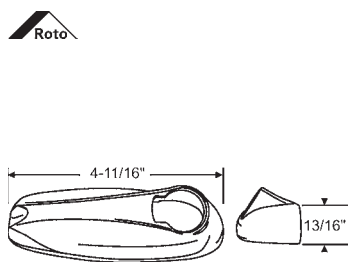

Part #	Hand	Finish
37-225BCH	Shown	Bright Chrome
37-226BCH	Opposite	Bright Chrome
37-225BRS	Shown	Brass Plated
37-226BRS	Opposite	Brass Plated
37-225ORBZ	Shown	Oil Rubbed Bronze
37-226ORBZ	Opposite	Oil Rubbed Bronze

Metal. Other Finishes Available

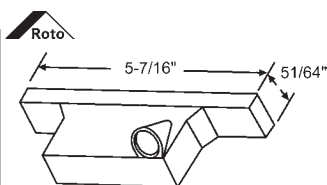

Part #	Hand	Finish
36-333CV-54	Shown	Brown
36-333CV-28	Shown	Almond
36-333CV-1	Shown	Bronze
36-333CV-10	Shown	Black

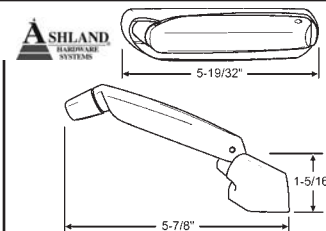

Part #	Hand	Finish
37-248W	Opposite	White
37-249W	Shown	White
37-248BZ	Opposite	Bronze
37-249BZ	Shown	Bronze

Handle and Cover

## CRANK HANDLES

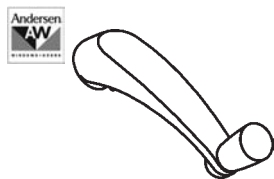

Part #	Finish
750-1361358	Stone
750-1361356	White

Classic Crank Handle with 3/8" Spline. Used with Classic Operator Cover 750-1361530

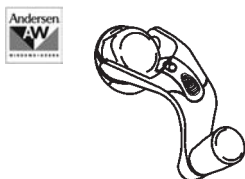

Part #	Finish
750-1361360	Stone
750-1361362	White

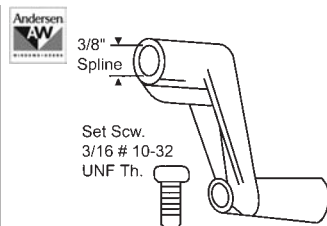

Part #	Finish
750-0532308	Bronze

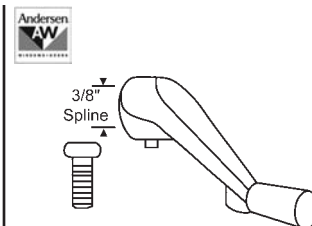

Part #	Finish
750-0532408	Stone
750-1351332	White



# WINDOW REPLACEMENT HARDWARE

## CRANK HANDLES

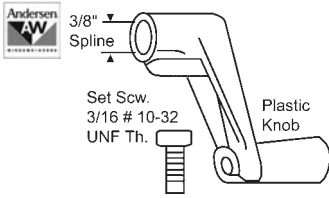

Part #	Finish
750-1361008	Silver

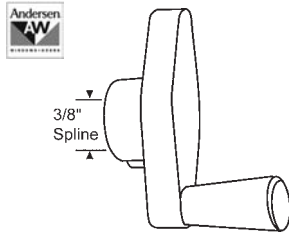

Part #	Finish
750-1361804	Stone

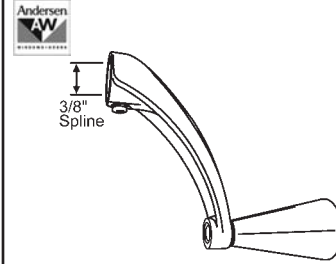

Part #	Finish
750-1361378	Stone
750-1361377	White

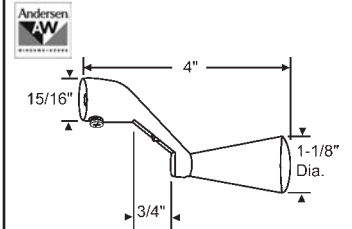

Part #	Finish
750-1361806	Stone
750-1351335	White

Easy Grip Handle

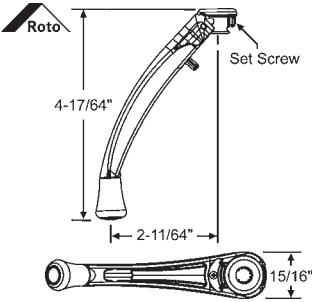

Part #	Finish
37-224W	White
37-224BCH	Bright Chrome
37-224BRS	Brass Plated
37-224ORBZ	Oil Rubbed Bronze
37-224BEW	Blue White

Folding Handle For X-Drive Operators.  
Other Finishes Available.

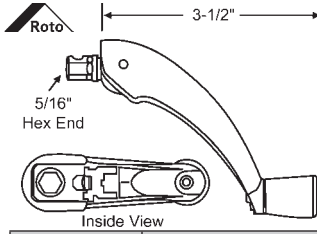

Part #	Finish
37-221BEW	Blue White
37-221W	White
37-221AD	Almond
37-221DBR	Dark Bronze
37-221EB	Earth Brown
37-221LAD	G2 Almond
37-221ORBZ	Oil Rubbed Bronze
37-221SV	Silver
37-221EW	G2 White

Folding Handle For Roto Pro Drive Operators

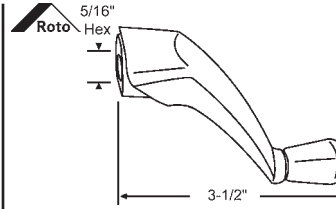

Part #	Finish
37-213BEW	Blue White
37-213AD	Almond
37-213CY	Clay
37-213EW	Euro White
37-213W	White

Folding Handle

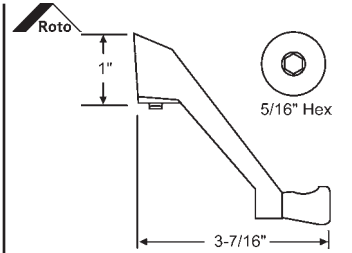

Part #	Finish
37-157W	White
37-157BEW	Blue White
37-157	Almond

With Set Screw

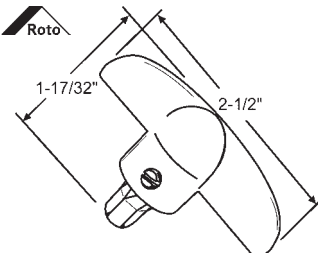

Part #	Finish
37-227CHP	Champagne
37-227CBZ	Chestnut Bronze
37-227W	White

Fits Old Style OP05 Pro Drive Operators

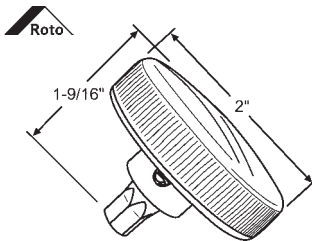

Part #	Finish
37-241CHP	Champagne
37-241CBZ	Chestnut Bronze
37-241W	White

Fits Old Style OP05 Pro Drive Operators

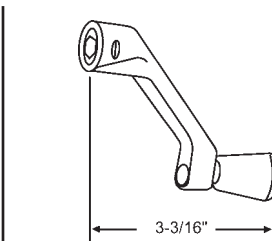

Part #	Finish
37-159WH	White
37-159	Aluminum

Fits Roto Operators 36-333SP, 36-334SP  
5/16" Hex

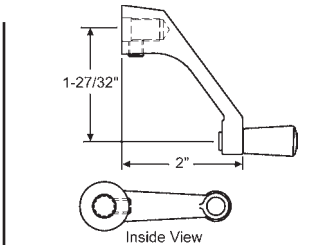

Part #	Finish
900-8890H	White Bronze w/ Stainless Steel Knob
900-8890HDBZ	Dark Bronze
900-8890HRBZ	Red Bronze
900-8890HWBZ	White Bronze

Fits Roto #900-8890 Operators

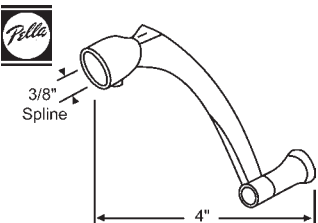

Part #	Finish
900-8869	Copperite
900-8869CH	Champagne
900-8869WH	White
900-8869BR	Brass Plated

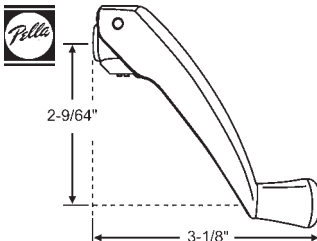

Part #	Finish
900-8869BR-F	Brass
900-8869CH-F	Champagne

Folding Handle



Part #	Finish
37-207W	White
37-207CHP	Champagne
37-207BP	Brass Plated

Integrated Crank Handle

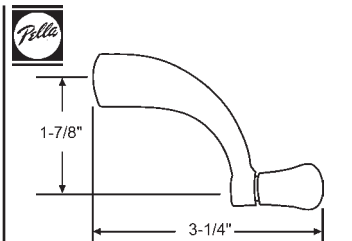

Part #	Finish
37-201-45	Blue White

# WINDOW REPLACEMENT HARDWARE

## CRANK HANDLES

TRUTH OPERATOR HANDLES (ONLY FIT TRUTH 11/32" SPLINE)

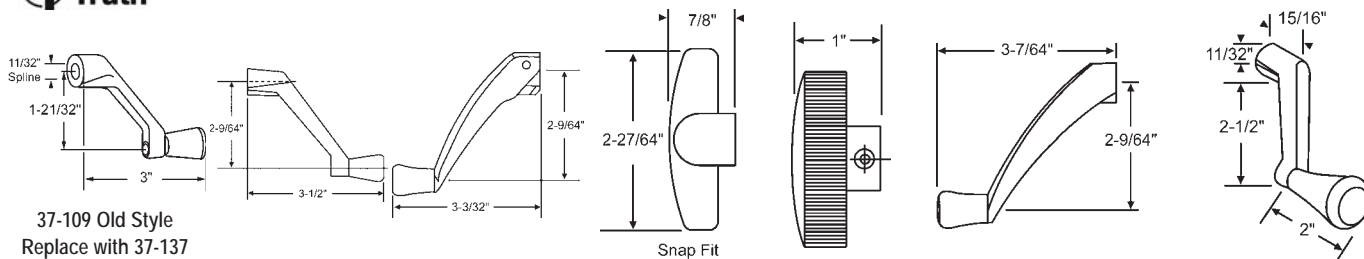

Finish	Long	Folding	"T"	Round	Contour Handle	ADA
Bronze	37-137-1	37-109FH-1	37-125-1	37-138-1	37-150-1	37-149-1
Gold	37-137-2	37-109FH-2	-	37-138-2	37-150-2	-
White	37-137-3	37-109FH-3	37-125-3	37-138-3	37-150-3	37-149-3
Brass	37-137-5	37-109FH-5	-	-	37-150-5	37-149-5
Clay	37-137-6	37-109FH-6	-	37-138-6	37-150-6	-
Aluminum	37-137-7	37-109FH-7	37-140-7	37-138-7	37-150-7	-
Chestnut Bronze	37-137-8	37-109FH-8	37-140-8	37-138-8	37-150-8	37-149-8
Beige	37-137-9	37-109FH-9	-	37-138-9	37-150-9	37-149-9
Medium Bronze	37-137-12	-	-	-	-	-
Brush Copper Nickel	37-137-13	37-109FH-13	37-140-13	-	37-150-13	37-149-13
Off-White	37-137-15	37-109FH-15	37-140-15	-	-	37-149-15
Black	37-137-10	37-109FH-10	37-140-10	-	37-150-10	-
Coppertone	-	37-109FH-75	-	37-138-75	37-150-75	-
Cocoa Brown	37-137-14	-	37-140-14	-	37-150-14	-
Bright White	37-137-29	37-109FH-29	37-140-29	-	37-150-29	-
Tuscan Bronze	37-137-38	37-109FH-38	-	-	37-150-38	-
Oil Rubbed Bronze	37-137-71	37-109FH-71	37-140-71	-	37-150-71	-
Gold (New)	37-137-87	37-109FH-87	-	-	37-150-87	-

Other finishes available. Check with your account manager.

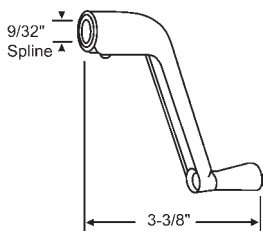

Part #	Finish
900-9690	Driftwood
900-9690W	White
900-9690B	Polished Brass

**PEACHTREE**

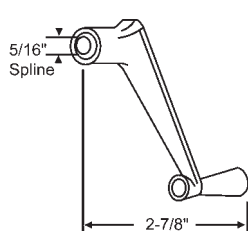

Part #	Finish
37-102	Aluminum
37-103	Light Bronze

**DORCHESTER**

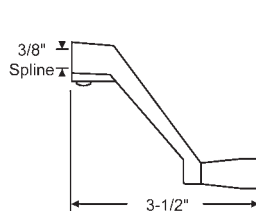

Part #	Finish
37-212	Aluminum
37-212BZ	Bronze
37-212W	White

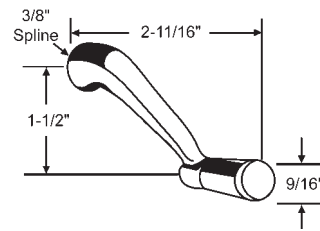

Part #	Finish
37-100	Aluminum
37-101	Brown
37-100W	White
37-101B	Bronze

# WINDOW REPLACEMENT HARDWARE

## CRANK HANDLES

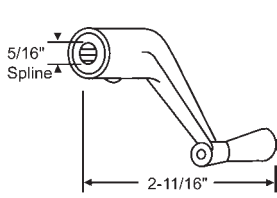

Part #	Finish
37-112	Aluminum
37-111	Brown
37-112DBZ	Dark Bronze
37-112W	White

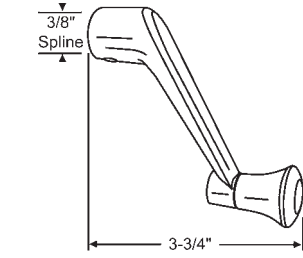

Part #	Finish
37-210	Mill
37-210W	White

**YALE**

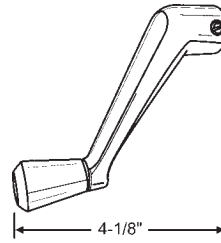

Part #	Finish
900-10708	Silver

7/16" Crank Handle

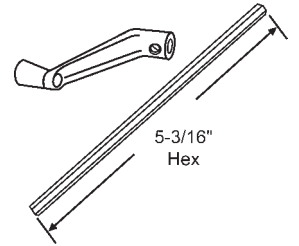

Part #	Finish
37-147	Mill

5/16" Hex Handle and Shaft

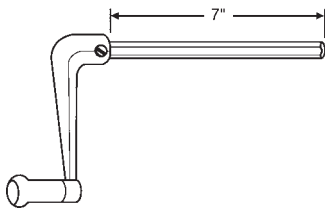

Part #	Finish
900-10738	Mill

5/16" Hex Handle and Shaft

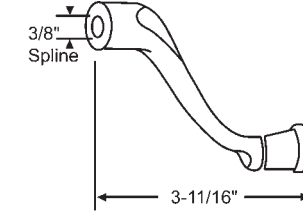

Part #	Finish
37-104	Aluminum
37-104W	White
37-105	Brown

For Awning Operators

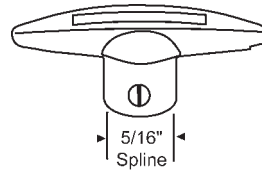

Part #	Finish
37-120	Mill
37-120B	Bronze

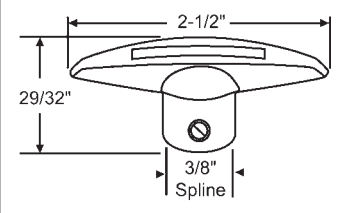

Part #	Finish
37-119	Aluminum
37-119B	Bronze
37-119W	White

Fits Old Style Steel Casement Operators

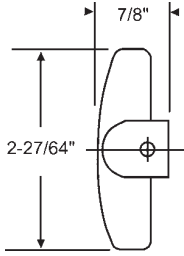

Part #	Finish
37-125-1	Bronze
37-125-3	White
37-125-4	Coppertone
37-125-8	Chestnut Bronze
37-125-9	Beige

Fits All Truth Operators with 11/32" Spline

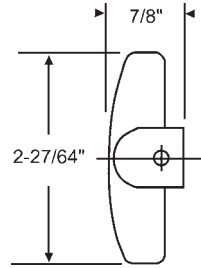

"T" Handle

Part #	Fits Mfg.	Spline Style	Finish
37-126	Andersen	3/8	Stone
37-126W		3/8	White
37-123	Peachtree	9/32"	Driftwood
37-123W		9/32"	White
37-113	Old Style	3/8	Aluminum
37-113W	Steel	3/8	White
37-113B	Casement	3/8	Brown

Part #	Fits Mfg.	Spline Style	Finish
37-106	Old Style Steel Casement	5/16	Aluminum
37-106BR		5/16	Brown
900-161	Jalousie	5/16	Aluminum
37-127		7/16	Bronze

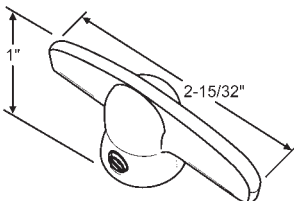

Part #	Spline Style	Finish
37-124	3/8 - 11	Copperite
37-124W	3/8 - 11	White
37-124CH	3/8 - 11	Champagne

Fits Pella

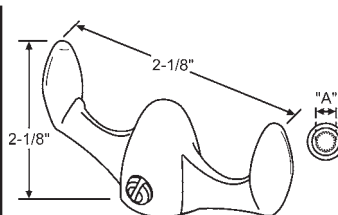

Part #	A
900-7837	5/8"
900-7837-3/8	3/8"

Aluminum Finish

**PARLYN**

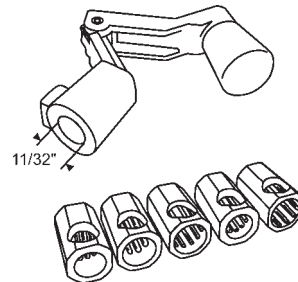

Fit-All Folding Handle Kit. Includes 5 adapters: 11/32", 5/16", 3/8", 9/32", 3/8" special. Will fit Truth, Andersen, Pella, Peachtree and various old style casement and jalousie operators

Part #	Finish
37-165U-2	Gold
37-165U-24	Brown
37-165U-3	White
37-165U-7	Aluminum
37-165U-75	Coppertone
37-165U-9	Beige
37-165U-MTBZ	Metallic Bronze

# WINDOW REPLACEMENT HARDWARE

## CRANK HANDLES

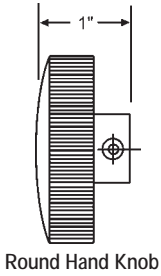

Part #	Fits Mfg.	Spline Style	Finish
37-133	Pella	3/8-11	Copperite
37-133W		3/8-11	White
37-133-35		3/8-11	Champagne
37-129	Andersen	3/8	Stone (Dark Gray)
37-129W		3/8	White
37-128	Peachtree	5/16	Light Brown

## PUSH BARS

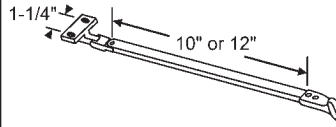

Part #	Length
29-105-10A	10"
29-105-12A	12"

Aluminum

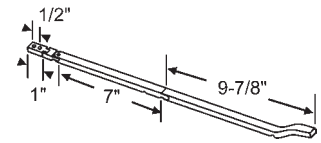

**29-107**  
Aluminum

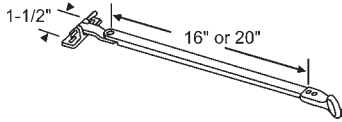

Part #	Length
29-109-20	20"

Aluminum Bar with Nickel Bronze Ends

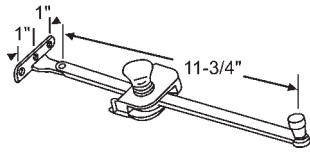

Part #	Hand
36-120	Shown
36-121	Opposite

Solid Brass Housing & Push Bar with Bracket. 29-110 Available Upon Request

**FENESTRA**

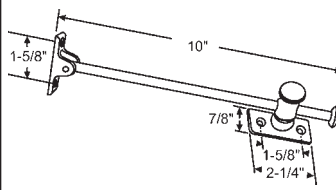

Part #	Length
900-339	Bright Nickel
900-339BRS	Bright Brass

Casement Adjuster

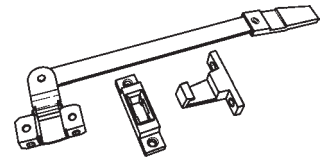

**29-270**  
Red R/V Push Bar Assembly  
**KINRO**

## TELESCOPING PUSH BARS



### Anderberg 44AL Series For Aluminum Windows

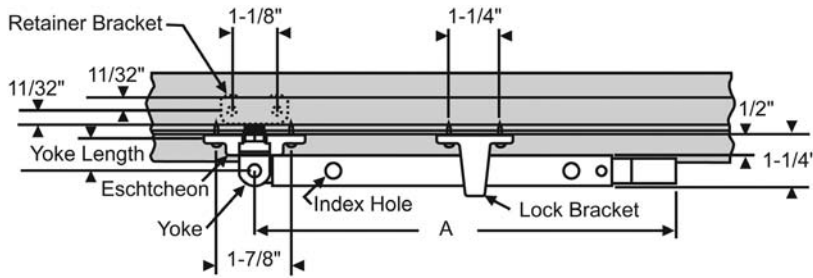

These Items Can Be Purchased Separately

**39-124-7**

Lock Bracket

**39-158-7**

Nylon Escutcheon

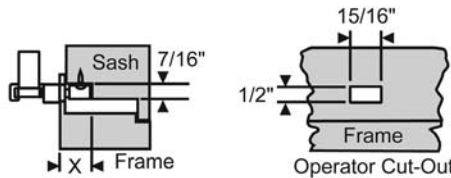

Truth Part #	Our Part #	X Dimension	Yoke Length	A Dimension		Finish
				Closed	Extended	
12.40.00.100	29-131-7	15/16"	25/32"	10-1/2"	16-1/4"	Aluminum
12.41.00.100	29-132-7	1"	27/32"	10-1/2"	16-1/4"	Aluminum
12.42.00.100	29-133-7	1"	27/32"	8"	11"	Aluminum
12.46.03.100	29-137-1	1-9/16"	1-13/32"	8"	11"	Bronze

# WINDOW REPLACEMENT HARDWARE

## TELESCOPING PUSH BARS



### Anderberg 44WD Series For Wood Windows

This Item Can Be  
Purchased Separately  
**39-158-7**  
Nylon Escutcheon

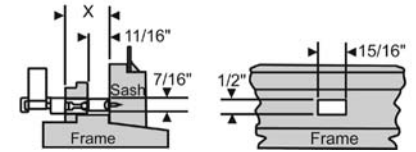
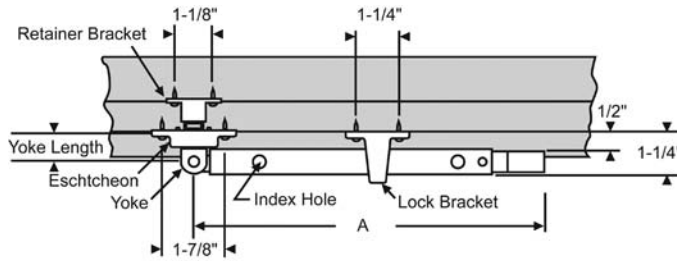

Truth Part #	Our Part #	X Dimension	Yoke Length	"A" Closed	"A" Extended	Finish
12.48.00.100	29-142-7	15/16"	25/32"	8"	11"	Aluminum
12.50.00.100	29-145-7	1"	27/32"	8"	11"	Aluminum
12.52.00.100	29-150-7	1-7/16"	1-9/32"	8"	11"	Aluminum
12.54.00.100	29-153-7	2"	27/32"	8"	11"	Aluminum

## VENT ARMS WITH BRACKETS

Our machine shop facilities can duplicate a variety of sizes and shapes of vent arms.  
The drawings below are just a representation of the various vent arms that are available. Please send us your sample so we can provide an exact replacement.

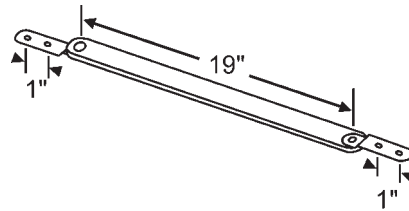
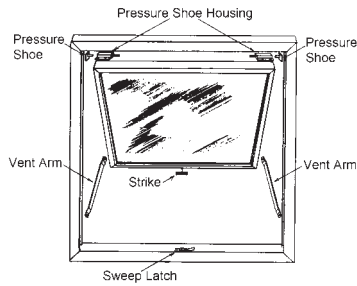

**28-50**  
2 Brackets. Aluminum

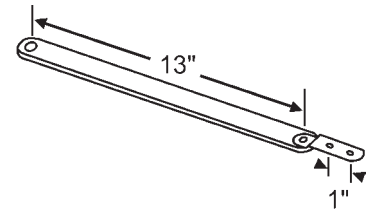

**28-51**  
1 Bracket. Aluminum

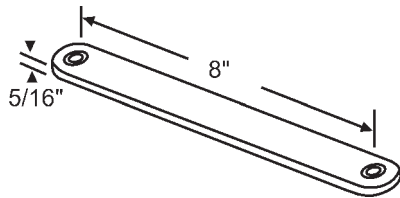

**28-52**  
Aluminum  
Bushing Only: 8-361

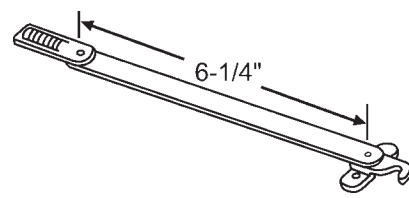

**28-53**  
Aluminum with Nylon End Piece and Hook. Set Includes  
Right Hand and Left Hand

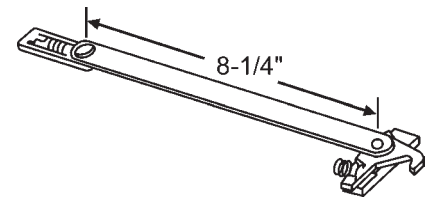

**28-61**  
Aluminum with Nylon End Piece and Hook. Set Includes  
Right Hand and Left Hand

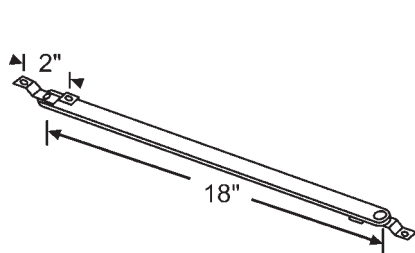

**28-55**  
Aluminum

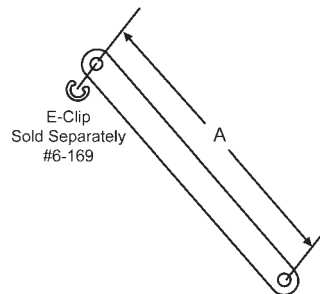

Part #	Description	A
28-79A	for 24" Wide Vent	6-1/2"
28-79B	for 18" Wide Vent	3-1/2"
28-79C	for 30" to 36" Wide Vent	9-7/16"

Drag Arm  
**PEACHTREE**

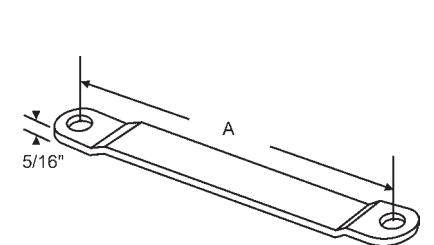

Part #	"A"
900-10601	7-3/4"
900-10602	18-1/4"

Aluminum

# WINDOW REPLACEMENT HARDWARE

## PRESSURE SHOES, FRICTION SHOES & HOUSINGS

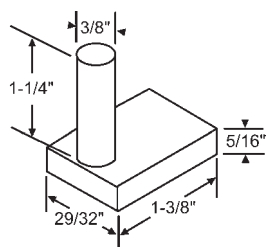

**26-118**

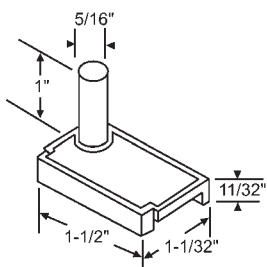

Part #	Hand
26-121	Shown
26-120	Opposite

Nylon Shoes

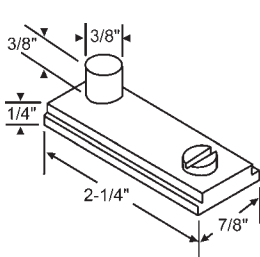

Part #	Hand
26-59	Shown
26-58	Opposite

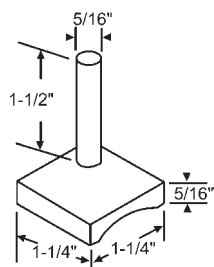

Part #	Hand
26-66	Shown
26-65	Opposite

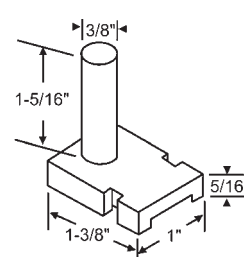

**26-68**  
Notched

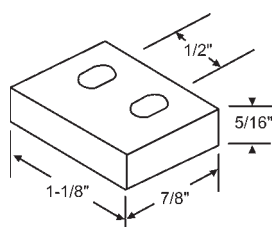

**26-76**  
Housing Only

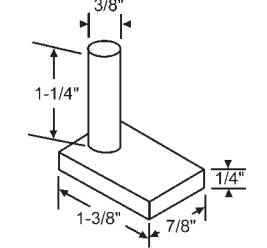

Part #	Hand
26-111	Shown
26-110	Opposite

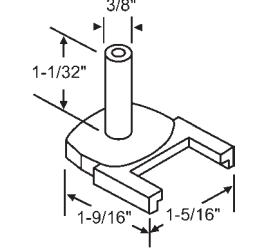

**26-100**

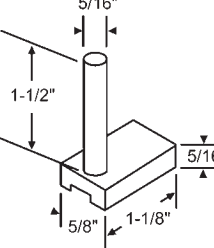

**26-101**

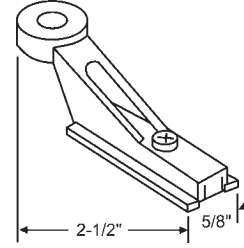

**26-102**

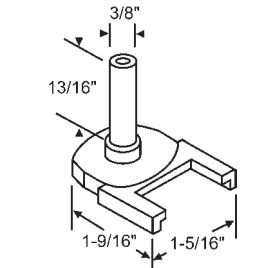

**26-103**  
Used with Bushing 8-361

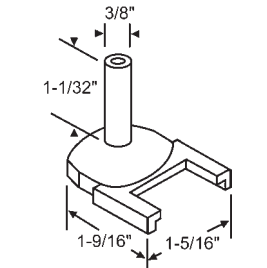

**26-104**

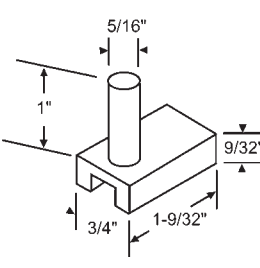

**26-105**

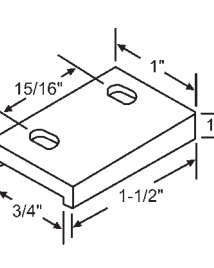

**26-116**

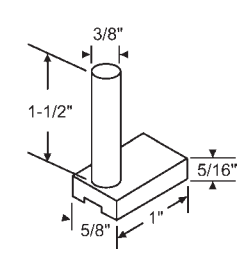

**26-117**

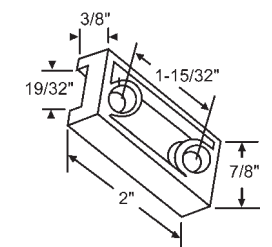

**26-123**

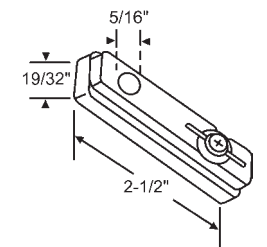

**26-122**

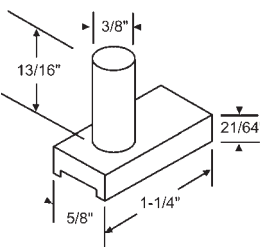

**26-55**  
Metal Pin

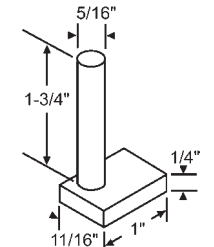

Part #	Hand
26-57	Shown
26-56	Opposite

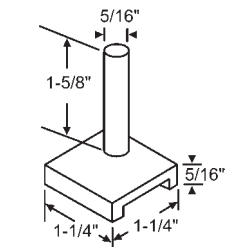

Part #	Hand
26-63	Shown
26-62	Opposite

# WINDOW REPLACEMENT HARDWARE

## PRESSURE SHOES, FRICTION SHOES & HOUSINGS

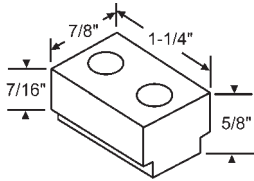

**26-67**  
Aluminum

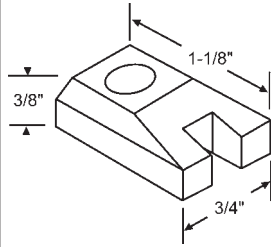

**26-74**

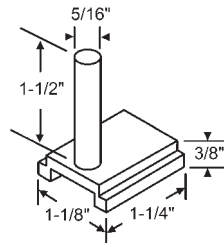

**26-69**

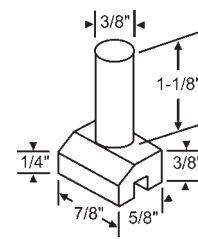

Part #	Base Type
26-72	Nylon

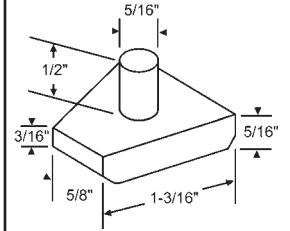

**26-81**

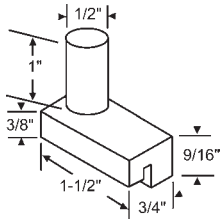

Part #	Hand
26-84	Shown
26-83	Opposite

Nylon Shoe with Aluminum Pin

Part #	Hand
26-84P	Shown

Nylon Shoe with Nylon Pin

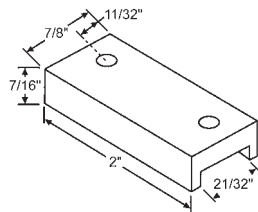

**26-85**

Fits both RH and LH  
White Nylon

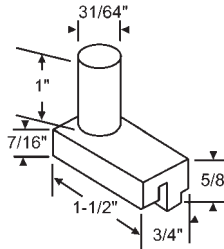

Part #	Hand
26-88	Shown
26-87	Opposite

Nylon Shoe with Aluminum Pin

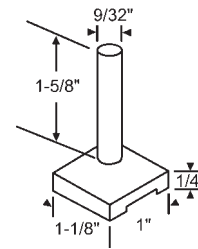

Part #	Hand
26-99	Shown
26-98	Opposite

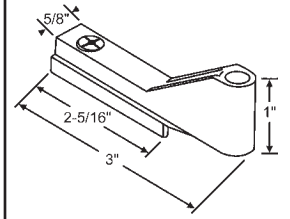

**900-20957**  
Metal Bracket

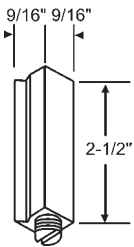

**26-113**  
Housing with Screw.  
Aluminum

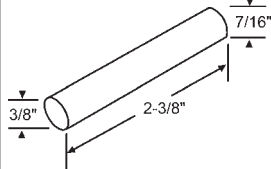

**26-115**  
Pressure Shoe Pin

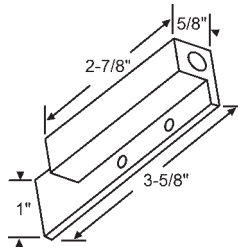

Part #	Hand
26-61	Shown
26-60	Opposite

Aluminum

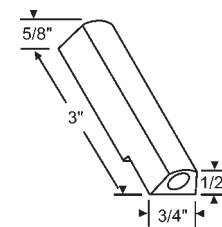

**26-75**  
Three 10-24 Tapped Mounting  
Holes on Underside; Set Screw  
Only: 26-75S

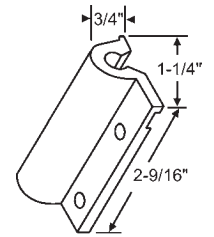

Part #	Hand
26-80	Shown
26-79	Opposite

Aluminum

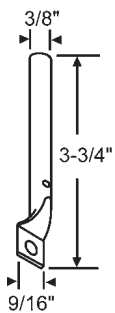

**26-82**  
Brass

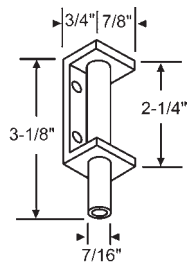

**26-89**  
Aluminum



**900-12627**  
Pressure Shoe Spring  
.50 Gauge Steel.

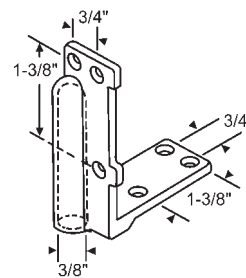

Part #	Hand
26-129	Shown
26-128	Opposite

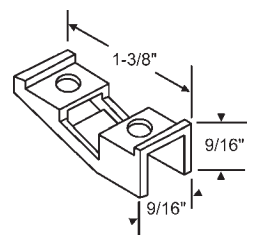

**26-124**  
Project Out Guide

# WINDOW REPLACEMENT HARDWARE

## CASEMENT AND AWNING TRACKS

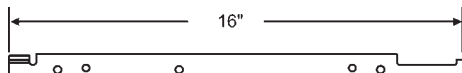

Part #	Hand
750-1361414	Shown
750-1361415	Opposite

Corrosion Resistant

Part #	Hand
750-1361412	Shown
750-1361413	Opposite

Steel

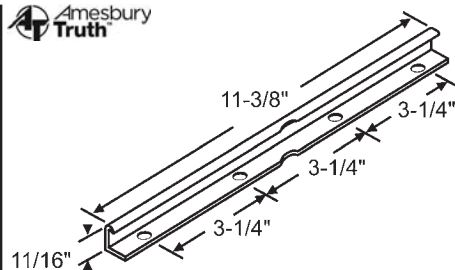

Part #	Material
38-53	Steel
38-53CG	Coast-Gard

For Casement Windows

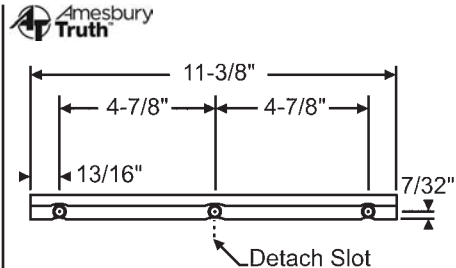

Part #	Material
38-55	Steel
38-55SS	Stainless Steel

For Casement Windows

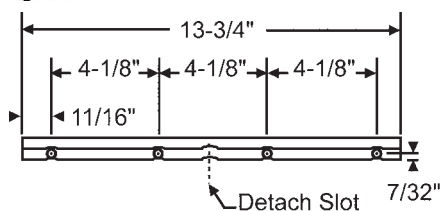

Part #	Material
38-59	Steel

For Casement Windows

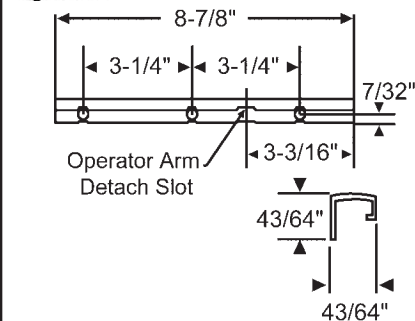

Part #	Material
38-65	Steel

For Casement Windows

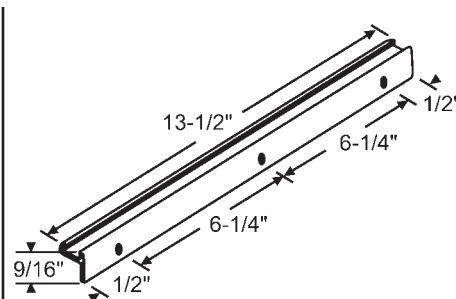

Part #	Material
38-54	Aluminum

For Casement Windows  
**DORCHESTER**

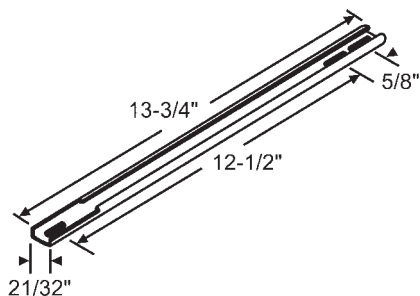

Part #	Material
38-51ST	Steel

For Casement Windows  
**DORCHESTER**

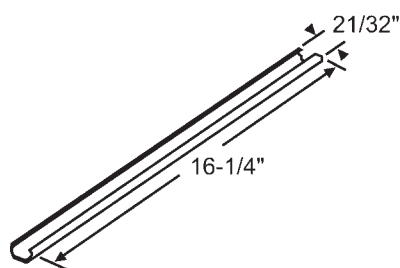

Part #	Material
38-52	Steel

Rust Resistant Coating  
For Awning Windows

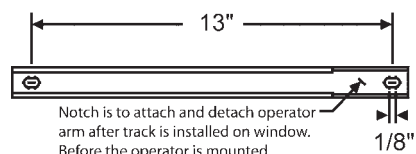

Part #	Material
38-58	Stainless Steel

For Awning Windows

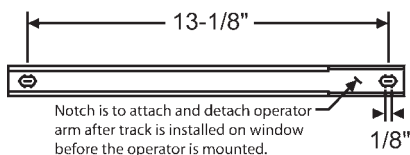

Part #	Material
38-60	Stainless Steel

For Casement Windows

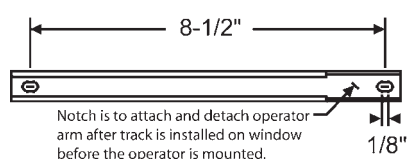

Part #	Material
38-62	Stainless Steel

For Casement Windows

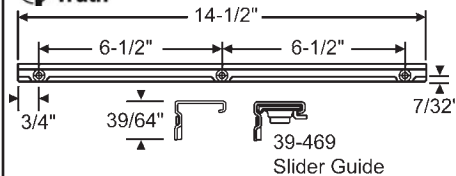

Part #	Material
38-67	Aluminum
38-67SS	Stainless Steel

Maxim Casement Track with Slider Guide



# WINDOW REPLACEMENT HARDWARE

## CASEMENT AND AWNING TRACKS

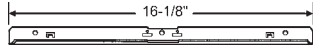

Part #	Material
750-0565808	Aluminum

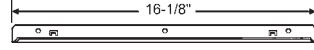

Part #	Material
750-1361204	Aluminum

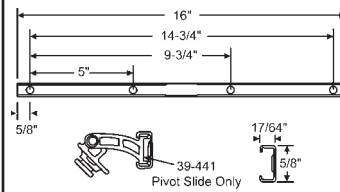

Part #	Material
38-68	Aluminum
38-68SS	Stainless Steel

For Awning Windows with Pivot Slides (2)

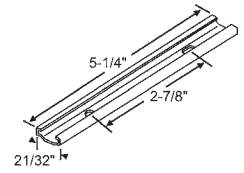

Part #	Material
38-1	Steel

For Casement Windows

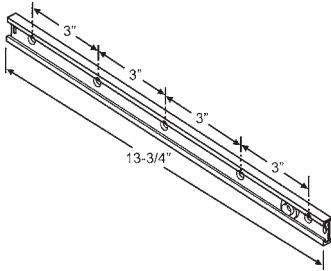

Part #	Material
38-172	Aluminum

Surface Mount Track & Roller

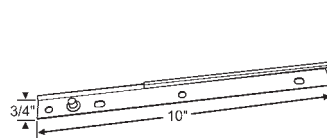

Part #	Material
900-21353T	Steel

For Casement Windows. Pair

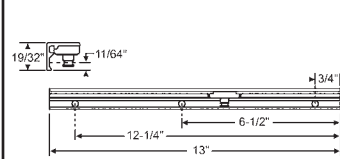

Part #	Material
38-21	Aluminum

Face Mount Track Assembly. Use with Slider Guide 39-753 on page 232.

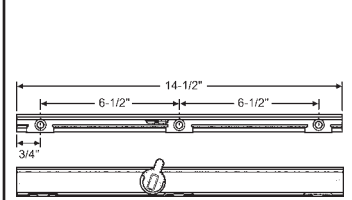

Part #	Material
38-78	Stainless Steel

## AWNING HINGES

### TRUTH 13 CONCEALED AWNING HINGE

Truth Part #	Finish	Our Part #	Sash Height	Maximum Sash Weight	Hinge Length "L"	"B"	"C"	"D"	"E"
13.13	E-Gard	28-10-14LH & RH	10"-14"	7 LBS.	10"	6-1/4"	4-1/4"	2-5/8"	1-1/4"
13.43	Stainless Steel	28-10-14LHSS & RHSS	10"-14"	7 LBS.	10"	6-1/4"	4-1/4"	2-5/8"	1-1/4"
13.14	E-Gard	28-14-14LH & RH	14"-19"	20 LBS.	14"	6-1/4"	4-1/4"	2-5/8"	1-1/4"
13.44	Stainless Steel	28-14-14LHSS & RHSS	14"-19"	20 LBS.	14"	6-1/4"	4-1/4"	2-5/8"	1-1/4"
13.15	E-Gard	28-18-14LH & RH	19"-26"	38 LBS.	18"	8-1/4"	6-1/4"	2-5/8"	1-1/4"
13.42	Stainless Steel	28-18-14LHSS & RHSS	19"-26"	38 LBS.	18"	8-1/4"	6-1/4"	2-5/8"	1-1/4"
13.16	E-Gard	28-22-14LH&RH	26"-34"	50 LBS.	22"	10-1/4"	6-1/4"	2-5/8"	1-1/4"
13.45	Stainless Steel	28-22-14LHSS & RHSS	26"-34"	50 LBS.	22"	10-1/4"	6-1/4"	2-5/8"	1-1/4"
13.17	E-Gard	28-26-14LH&RH	34"-42"	61 LBS.	26"	12-1/4"	8-1/4"	5-7/16"	2-5/8"

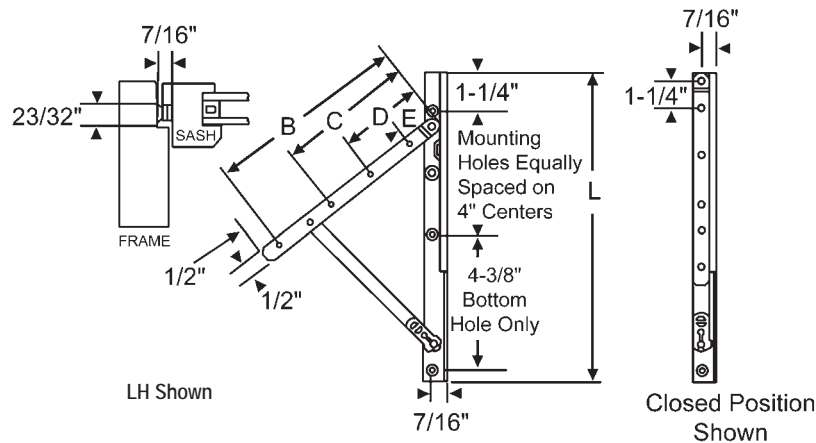

# WINDOW REPLACEMENT HARDWARE

## CASEMENT HINGES

### TRUTH 14 CONCEALED CASEMENT HINGE

Truth Part #	Finish	Our Part #	"A"	"C"	"D"	"L"	Arm & Rivet	Attachment
14.05	E-Gard	28-15-37 (LL-UR) / 28-15-38 (UL-LR)	4-29/32"	9-5/8"	4-15/16"	10"	Steel	Adjustable Brass Snap-Stud
14.06	E-Gard	28-15-43 (LL-UR) / 28-15-44 (UL-LR)	5-17/32"	9-5/8"	4-15/16"	10"	Steel	Adjustable Brass Snap-Stud
14.08	E-Gard	28-15-49 (LL-UR) / 28-15-50 (UL-LR)	6-15/16"	13-5/8"	4-51/64"	14"	Steel	Adjustable Brass Snap-Stud
14.75	E-Gard	28-15-5 (LL-UR) / 28-15-6 (UL-LR)	4-29/32"	9-5/8"	4-15/16"	10"	Steel	Standard Brass Snap-Stud
14.80	Stainless Steel	28-15-5SS (LL-UR) / 28-15-6SS (UL-LR)	4-29/32"	9-5/8"	4-15/16"	10"	Stainless Steel	Stainless Steel Snap-Stud
14.76	E-Gard	28-15-7 (LL-UR) / 28-15-8 (UL-LR)	5-17/32"	9-5/8"	4-15/16"	10"	Steel	Standard Brass Snap-Stud
14.91	Stainless Steel	28-15-7SS (LL-UR) / 28-15-8SS (UL-LR)	5-17/32"	9-5/8"	4-15/16"	10"	Stainless Steel	Stainless Steel Snap-Stud
14.77	E-Gard	28-15-9 (LL-UR) / 28-15-10 (UL-LR)	2-9/32"	9-5/8"	4-15/16"	10"	Steel	Standard Brass Snap-Stud
14.93	Stainless Steel	28-15-9SS (LL-UR) / 28-15-10SS (UL-LR)	2-9/32"	9-5/8"	4-15/16"	10"	Stainless Steel	Stainless Steel Snap-Stud
14.17	E-Gard	28-15-1 (LL-UR) / 28-15-2 (UL-LR)	6-15/16"	13-5/8"	4-25/32"	14"	Steel	Standard Brass Snap-Stud



Not for Use on Awning Windows.

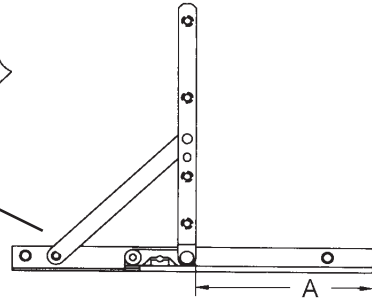
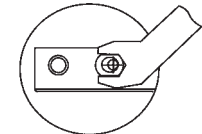

LL-UR Hinge Shown (Viewed from Outside)

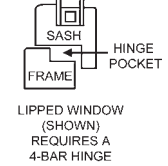
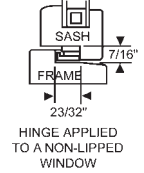
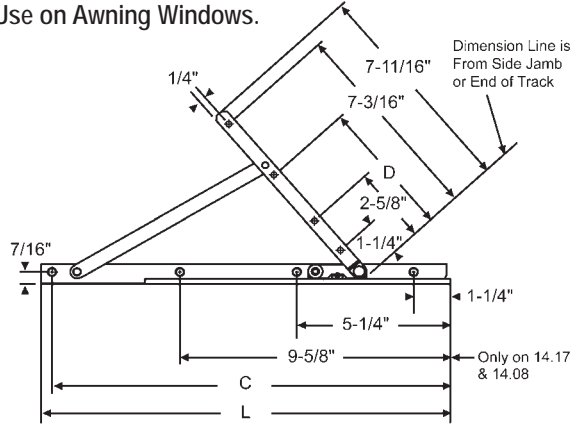

#### Instructions for Sash Adjustment

1. The amount of sash sag that the HP hinge will correct for is dependent on the ratio of the sash width vs. sash height. To calculate the amount of drag adjustment for any given sash size, take the ratio of width to height multiplied by 1/16". Example: Sash size equals 24" x 36", width to height ratio is .667. Total adjustment is  $.667 \times 1/16" = .042$  (approx. 3/64").
2. To adjust a casement sash, first fully open the casement window. Next, loosen the two screws in the bottom hinge adjustment block approximately three turns (do not remove screws). Next, move heel of the sash towards the lock side of the window and re-tighten screws. For severe sash drag, repeat this procedure to the top hinge, except the adjustment is made by shifting the top of the window away from the lock side.

### TRUTH'S CONCEALED MAXIM® HINGES

14.97 Washability Hinge has the ability to support a 40" x 84" sash weighing up to 96 lbs., when used with the Maxim® Dual Arm Operator.

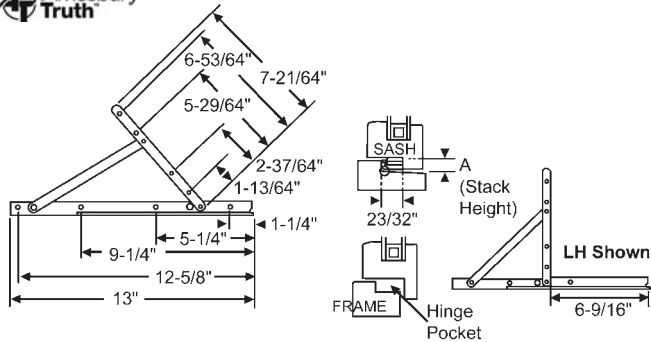

Truth Part #	Part #	Hand	Finish	A
14.97	28-15-39	Shown	E-Gard	7/16"
14.97	28-15-40	Opposite	E-Gard	7/16"
14.97	28-15-39SS	Shown	Stainless Steel	7/16"
14.97	28-15-40SS	Opposite	Stainless Steel	7/16"
14.92	28-15-57	Shown	E-Gard	1/2"
14.92	28-15-58	Opposite	E-Gard	1/2"
14.92	28-15-57SS	Shown	Stainless Steel	1/2"
14.92	28-15-58SS	Opposite	Stainless Steel	1/2"

14.12 Egress Hinge has the ability to support a sash weighing up to 69 lbs., when used with the Maxim® Dual Arm Operator.

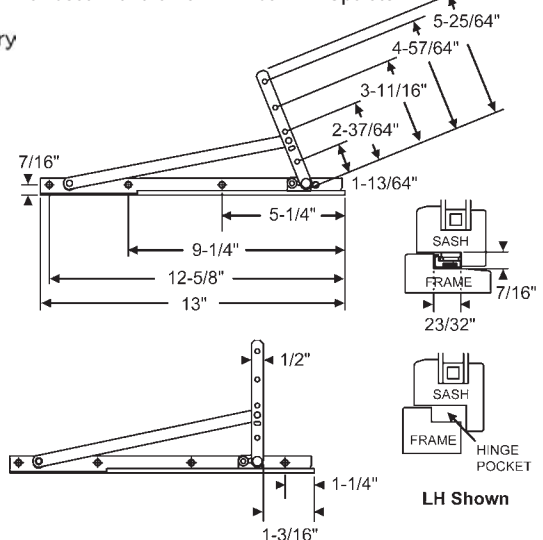

Truth Part #	Part #	Hand	Finish
14.12	28-15-41	Shown	E-Gard
14.12	28-15-42	Opposite	E-Gard
14.12	28-15-41SS	Shown	Stainless Steel
14.12	28-15-42SS	Opposite	Stainless Steel

# WINDOW REPLACEMENT HARDWARE

## CASEMENT AND AWNING HINGES

### TRUTH'S ANDERBERG 77AL SERIES HINGE

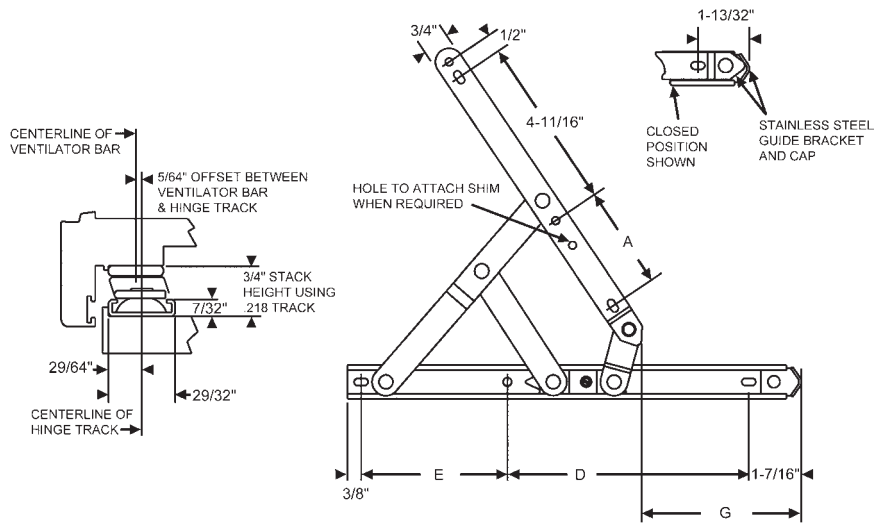

Our Part #	Hinge Length	A	D	E	G
28-10-6	10"	1-13/16"	6-11/32"	2-1/4"	4"
28-12-6	12"	2-13/16"	6-19/32"	4"	4"
28-14-6	14"	3-13/16"	6-15/16"	5-21/32"	4-3/8"
28-16-6	16"	4-13/16"	7-21/32"	6-15/16"	5-1/4"
28-18-6	18"	5-13/16"	8-9/32"	8-5/16"	5-3/4"

Truth Part #	Size	Description	Vent Height Range	Max. Vent Weight	Degree of Opening	Our Part Number	Features
34.47.00.101	10"	Aluminum 4 Bar Hinge w/Stop	12" - 20"	58	63	28-10-6-07	.350 Track with .125 Shim
34.47.00.105	10"	Aluminum 4 Bar Hinge w/Stop	12" - 20"	58	63	28-10-6-06	.350 Track with .187 Shim
34.47.00.107	10"	Aluminum 4 Bar Hinge w/Stop	12" - 20"	58	63	28-10-6-09	.385 Track with No Shim
34.48.00.107	12"	Aluminum 4 Bar Hinge w/Stop	20" - 23"	67	54	28-12-6-10	.218 Track with No Shim
34.48.00.103	12"	Aluminum 4 Bar Hinge w/Stop	20" - 23"	67	54	28-12-6-37	.350 Track with .187 Shim
34.49.00.100	14"	Aluminum 4 Bar Hinge w/Stop	23" - 27"	79	50	28-14-6-18	.218 Track with No Shim
34.49.00.102	14"	Aluminum 4 Bar Hinge w/Stop	23" - 27"	79	50	28-14-6-24	.350 Track with No Shim
34.49.00.105	14"	Aluminum 4 Bar Hinge w/Stop	23" - 27"	79	50	28-14-6-36	.350 Track with .125 Shim
34.49.00.104	14"	Aluminum 4 Bar Hinge w/Stop	23" - 27"	79	50	28-14-6-25	.385 Track with No Shim
34.50.00.104	16"	Aluminum 4 Bar Hinge w/Stop	27" - 30"	88	50	28-16-6-22	.350 Track with No Shim
34.50.00.101	16"	Aluminum 4 Bar Hinge w/Stop	27" - 30"	88	50	28-16-6-25	.385 Track with No Shim
34.51.00.100	18"	Aluminum 4 Bar Hinge w/Stop	30" - 35"	102	50	28-18-6-18	.218 Track with No Shim
34.51.00.101	18"	Aluminum 4 Bar Hinge w/Stop	30" - 35"	102	50	28-18-6-19	.218 Track with .187 Shim
34.51.00.103	18"	Aluminum 4 Bar Hinge w/Stop	30" - 35"	102	50	28-18-6-22	.350 Track with No Shim

# WINDOW REPLACEMENT HARDWARE

## CASEMENT AND AWNING HINGES

### TRUTH'S ANDERBERG 201 SERIES HINGE

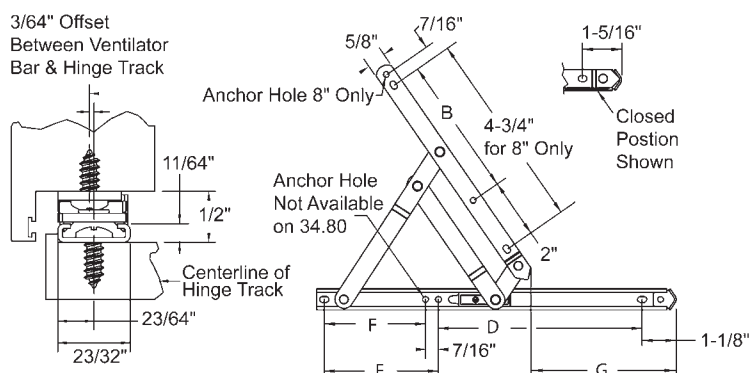

SS - Stainless Steel  
ST - Steel

Material	Length	Truth Part #	Our Part #	Stop/No Stop	Ventilator Bar	Track	STD Stop	No Stop Track	"G"		Degree of Opening
					"B"	"D"	"E"	"F"	STD Stop	No Stop	Stop
SS	8"	34.10.00.101	28-8-2-03	Stop	N/A	5-5/32"	1-5/8"	1-1/4"	3"	4-1/4"	54°
ST	8"	34.17.00.104	28-8-1-03	Stop	N/A	5-5/32"	1-5/8"	1-1/4"	3"	4-1/4"	54°
SS	10"	34.11.00.102	28-10-2-07	Stop	3-3/4"	6-1/32"	2-3/4"	2"	4"	5-13/32"	55°
SS	12"	34.12.00.100	28-12-2-07	Stop	4-3/4"	6-29/32"	3-7/8"	3"	4-7/8"	6-1/2"	55°
SS	14"	34.13.00.102	28-14-2-07	Stop	5-3/4"	7-25/32"	5"	3-3/4"	5-3/4"	7-23/32"	55°
SS	16"	34.14.00.100	28-16-2-07	Stop	6-3/4"	8-21/32"	6-1/8"	4-1/2"	6-1/8"	8-7/8"	55°
ST	16"	34.21.00.102	28-16-1-07	Stop	6-3/4"	8-21/32"	6-1/8"	4-1/2"	6-1/8"	8-7/8"	55°
SS	18"	34.15.00.102	28-18-2-07	Stop	7-3/4"	9-17/32"	7-1/4"	5-1/4"	7-7/16"	10"	55°
SS	20"	34.16.00.100	28-20-2-07	Stop	8-3/8"	10-13/32"	8-3/8"	6-1/4"	8-9/32"	11-5/32"	55°
ST	20"	34.23.00.102	28-20-1-07	Stop	8-3/8"	10-13/32"	8-3/8"	6-1/4"	8-9/32"	11-5/32"	55°

Note: Ask Account Manager About Variations if Chart Does not Meet Requirements

### TRUTH'S STANDARD DUTY STAINLESS STEEL 4-BAR EGRESS HINGES - ANDERBERG 222SS AND 224SS SERIES

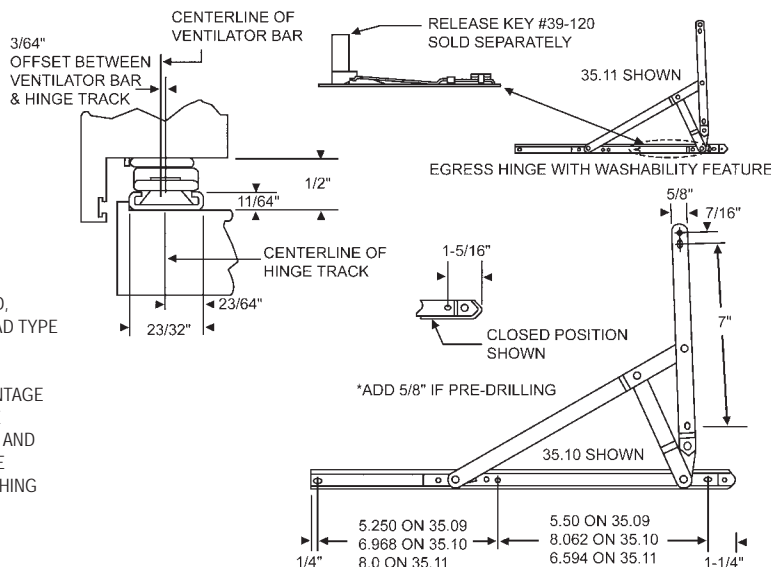

#### RECOMMENDED SCREWS:

6- NO. 10 SLOTTED OR NO. 6 PHILLIPS, PAN HEAD, STAINLESS STEEL SCREWS (LENGTH AND THREAD TYPE TO BE DETERMINED BY PROFILE DESIGN).

NOTE: THE 35.11 HINGE OFFERS YOU THE ADVANTAGE OF ALLOWING THE OUTSIDE OF THE VENT TO BE WASHED FROM THE INSIDE BY INSERTING A KEY AND SLIDING THE CASEMENT WINDOW TOWARDS THE CENTER OF THE FRAME OPENING GIVING A WASHING SPACE OF APPROXIMATELY 4-1/2\".

Truth Part #	Part Number	Description	Stop
35.09.00.100	28-12.2-00	12-1/4" w/Stop	90°
35.09.00.101	28-12.2-01	12-1/4" w/Stop and Loose Rivet	90°
35.10.00.100	28-16.2-00	16-1/8" w/Stop	90°
35.10.00.101	28-16.2-01	16-1/8" w/Stop and Loose Rivet	90°
35.11.00.100	28-16.2-02	16-1/8" w/Stop and Washability Feature	90°
35.11.00.101	28-16.2-03	16-1/8" w/Stop, Loose Rivet and Washability Feature	90°

# WINDOW REPLACEMENT HARDWARE

## CASEMENT AND AWNING HINGES

TRUTH'S ANDERBERG 301SS, 301ST and 301AL SERIES HINGE



### Part Number Guide

Add the suffix of the specific feature you require on the hinge to complete our part number

Material	Size	Truth Part #	Our Part #	Stop	No Stop	Loose Rivets*	.125 Shim	.187 Shim	.250 Shim	.312 Shim	Alum. Hinges Only			
											.218 Track		.350 Track	.385 Track
											.125 Shim	.250 Shim		
SS	10"	34.24.00	28-10-3	-03	-00	-04	-06	-07	-84	-87				
ST	10"	34.33.00	28-10-4	-03			-06	-05						
AL	10"	34.41.00	28-10-5								-61	-63	-64	-66
SS	12"	34.25.00	28-12-3	-14		-15	-17				-73	-72	-71	-52
AL	12"	34.42.00	28-12-5											75
SS	14"	34.26.00	28-14-3	-21	-00		23	22	-84					
ST	14"	34.35.00	28-14-4	-21			-23	21B						
SS	16"	34.27.00	28-16-3	-25			-01		29					
ST	16"	34.36.00	28-16-4	25										
SS	18"	34.28.00	28-18-3	25			08		84					
ST	18"	34.37.00	28-18-4	-25				-27						
SS	20"	34.29.00	28-20-3	-25			-28	-27	29					
ST	20"	34.38.00	28-20-4	-25										
SS	24"	34.31.00	28-24-3	-09			-08	-11	-12					
ST	24"	34.39.00	28-24-4	-09				-07						
SS	28"	34.86.00	28-28-3	45										

Dark Gray Vertical Columns Denote Hinges without Stops (Maximum Opening)

\*Loose rivets are usually used when less friction is needed and used with an operator.

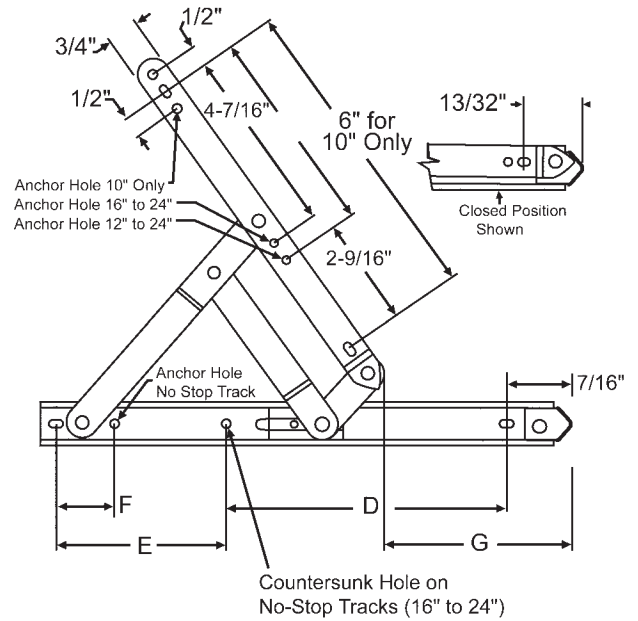
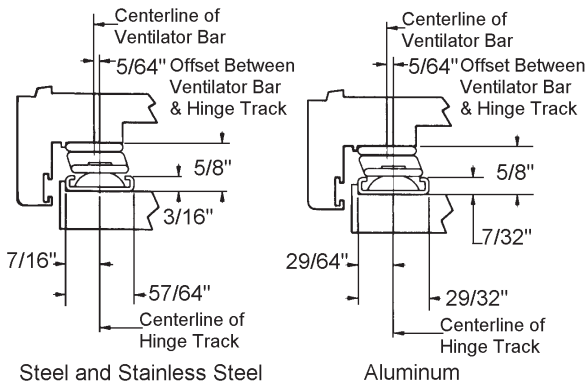

Truth Part #			Hinge Length	Vent Hinge Range	Maximum Vent Wt.	Ventilator Bar B	Track D	Std. Stop E	No-Stop Track F	G		Degree of Opening	
SS	ST	AL								Std. Stop	No Stop	Std. Stop	No Stop
34.24	34.33	34.41	10"	12"-20"	58	N/A	6-11/32"	2-1/4"	1-3/8"	4"	6-1/4"	58°	77°
34.25	34.34	34.42	12"	20"-25"	73	4-15/16"	6-19/32"	4"	1-5/8"	4-1/4"	7-3/4"	52°	77°
34.26	34.35	34.43	14"	23"-29"	85	5-15/16"	6-15/16"	5-21/32"	2-1/8"	4-1/4"	9-1/4"	48°	77°
34.27	34.36	34.44	16"	25"-34"	99	6-15/16"	7-21/32"	6-15/16"	2-5/8"	5-3/32"	10-3/4"	49°	77°
34.28	34.37	34.45	18"	32"-37"	108	7-15/16"	8-9/32"	8-5/16"	8-1/8"	5-3/4"	12-1/4"	49°	77°
34.29	34.38	34.46	20"	34"-40"	117	8-15/16"	8-31/32"	9-5/8"	3-5/8"	6-7/16"	13-13/16"	49°	77°
34.31	34.39	N/A	24"	40"-44"	129	10-15/16"	9-3/32"	13-1/2"	4-5/8"	6-3/4"	16-7/8"	45°	77°
34.86	N/A	N/A	28"	50"-64"	175	12-15/16"	9-19/32"	17"	N/A	7-1/2"	N/A	40°	N/A

# WINDOW REPLACEMENT HARDWARE

## CASEMENT AND AWNING HINGES

### TRUTH'S HEAVY DUTY STAINLESS STEEL 4-BAR EGRESS HINGES - ANDERBERG 333SS AND 334SS SERIES



#### RECOMMENDED SCREWS:

6- NO. 10 PHILLIPS, PAN HEAD, STAINLESS STEEL SCREWS (LENGTH AND THREAD TYPE TO BE DETERMINED BY PROFILE DESIGN).

NOTE: 1- THE 35-13 HINGE OFFERS YOU THE ADVANTAGE OF ALLOWING THE OUTSIDE OF THE VENT TO BE WASHED FROM THE INSIDE BY INSERTING A KEY AND SLIDING THE CASEMENT WINDOW TOWARDS THE CENTER OF THE FRAME OPENING GIVING A WASHING SPACE OF APPROXIMATELY 4-1/2".

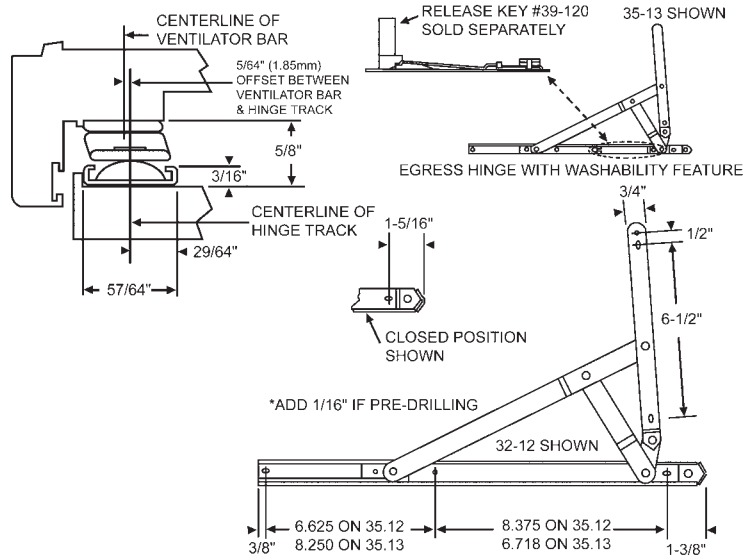

Truth Part #	Part Number	Description	Stop
35.12.00.100	28-16.5-00	16-1/2" w/Stop	90°

### TRUTH'S STANDARD DUTY STAINLESS STEEL CASEMENT HINGES - ANDERBERG 401 SERIES

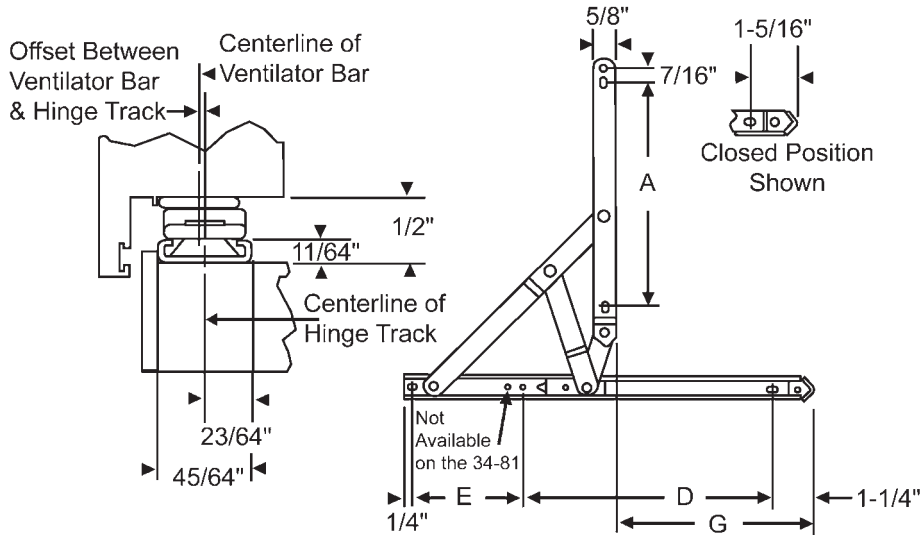

Truth Part #	Our Part #	Hinge Length	"A"	"D"	"E"	"G"	Stop
34.55.00.100	28-12-12-0	12"	6-3/4"	7-15/32"	3-5/16"	5-15/16"	90°
34.56.00.100	28-14-12-0	14"	7-9/32"	8-5/32"	4-5/8"	6-3/16"	90°

# WINDOW REPLACEMENT HARDWARE

## CASEMENT AND AWNING HINGES

### HEAVY DUTY STAINLESS STEEL CASEMENT HINGES - ANDERBERG 601 SERIES

### TRUTH'S SUPERIOR 4-BAR HINGE - ANDERBERG 301 SERIES

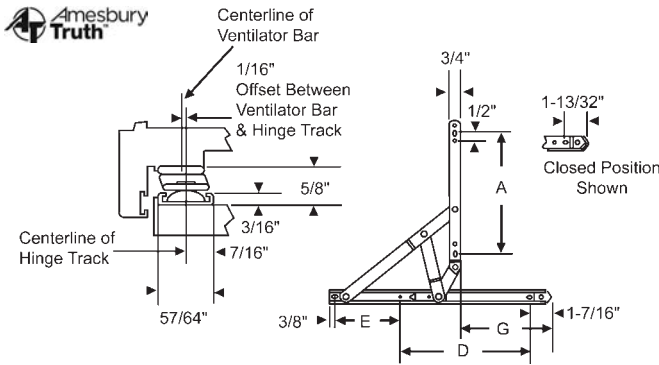

Truth Part #	Our Part #	Hinge Length	"A"	"D"	"E"	"G"	Stop
34.59.00.100	28-14-13-0	14"	8"	8-13/32"	4-3/16"	6"	90°
34.60.00.100	28-16-13-0	16"	8"	7-29/32"	6-11/16"	5-5/8"	90°
34.61.00.100	28-18-13-0	18"	8"	7-21/32"	8-15/16"	5-7/16"	90°

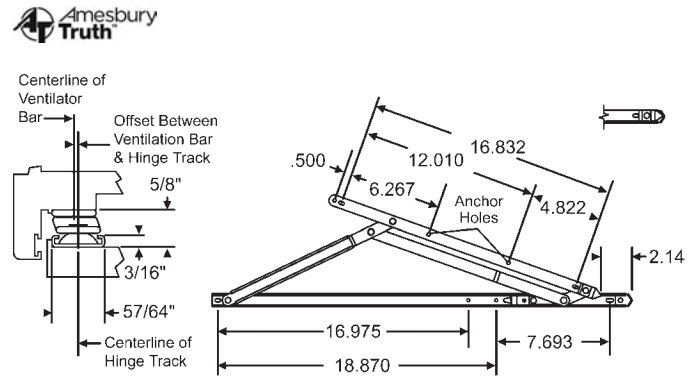

Truth Part #	Our Part #	Hinge Length	Vent Height Range	Degree of Opening	Maximum Vent Weight
34.87	28-28-15-2S	28"	64" to 86"	20°	300 lbs.

### 10" HP200 TRACK AND ARM CASEMENT HINGE ASSEMBLY

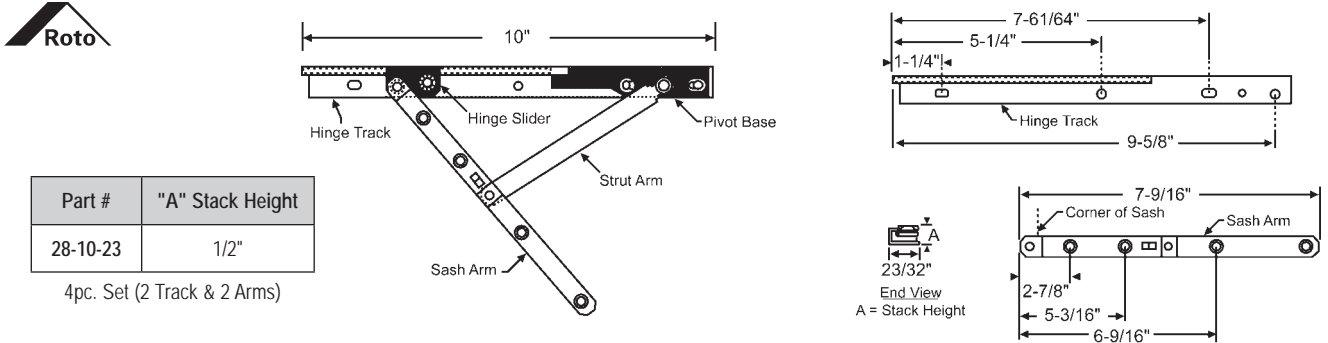

Part #	"A" Stack Height
28-10-23	1/2"

4pc. Set (2 Track & 2 Arms)

### HG05 CASEMENT HINGE\*

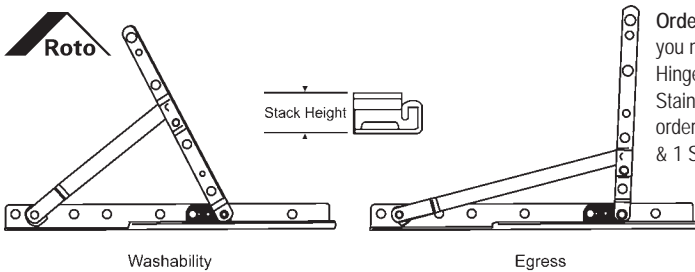

**Ordering Example:** If you need two 10" Steel Hinge Arms and two 10" Stainless Steel Tracks order 1 Set # 28R-10-1 & 1 Set # 28R-10T

The Roto HG05 Hinge series features 10" and 13" washability versions as well as a 10" egress version and is suitable for most casement and awning window applications (wood, vinyl, aluminum, and fiberglass). They are available in both 7/16" and 1/2" stack height versions, so there is no need for a spacer. The use of high quality materials and manufacturing processes makes this one of the strongest hinges on the market. The hinges are available in powder coated steel or Stainless Steel versions.

#### Features

Each hinge is equipped with Roto's quick disconnect feature that allows for easy snap connection between the sash and frame. With a simple turn of a wrench, the hinge adjusts to compensate for sash sag or window manufacturing variations, up to 3mm (.125). Additional holes in the hinge arms allow for installation into a bow/bay window and for adding a limiting device.

#### Performance

Hinge arms are rounded at the edges to resist binding and the track/slider overlaps by 2.7mm (0.106") to prevent disengagement. The hinge slider is reinforced with a stainless steel insert for greater rigidity and furnishes a 2mm clearance, eliminating interference with screws.

The HG05 hinge is AAMA 904 life cycle compliant at 125 lbs. on the 13" hinge and at 110 lbs. on the 10" version. Both steel versions are AAMA 907 corrosion compliant at 750 hours for powder coated and over 1000 hours for stainless steel. The hinges also pass ASTM E1886 and ASTM E1996 hurricane impact testing.

Hinge Arm Set	Arm Finish	Stainless Steel Hinge Track Set	Size	Stack Height	Version
28R-10-1	Powder Coated Steel	28R-10T	10"	7/16"	Washability
28R-10-1SS	Stainless Steel	28R-10T	10"	7/16"	Washability
28R-10-1E	Powder Coated Steel	28R-10T	10"	7/16"	Egress
28R-10-2	Powder Coated Steel	28R-10T	10"	1/2"	Washability
28R-10-2SS	Stainless Steel	28R-10T	10"	1/2"	Washability
28R-10-2E	Powder Coated Steel	28R-10T	10"	1/2"	Egress
28R-13-1	Powder Coated Steel	28R-13T	13"	7/16"	Washability
28R-13-2	Powder Coated Steel	28R-13T	13"	1/2"	Washability

\* Direct replacement for the Roto HG04 Casement Hinge.

# WINDOW REPLACEMENT HARDWARE

## CASEMENT AND AWNING HINGES

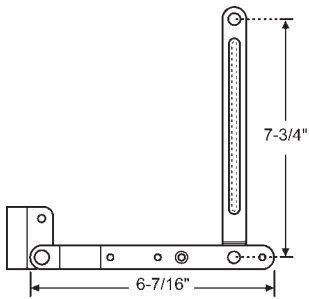

Part #	Hand
28-81RH	Shown
28-81LH	Opposite

Top Hinge Assembly  
**PEACHTREE**

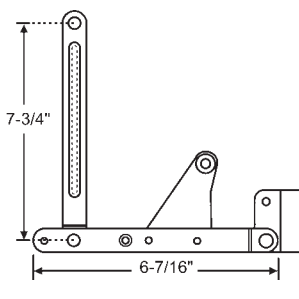

Part #	Hand
28-80RH	Shown
28-80LH	Opposite

Bottom Hinge Assembly  
**PEACHTREE**

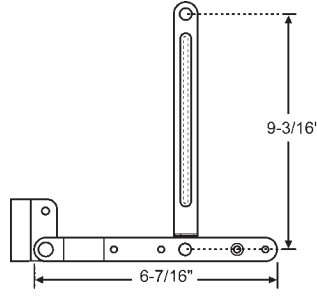

Part #	Hand
28-82RH	Shown
28-82LH	Opposite

Egress Top Hinge Assembly  
**PEACHTREE**

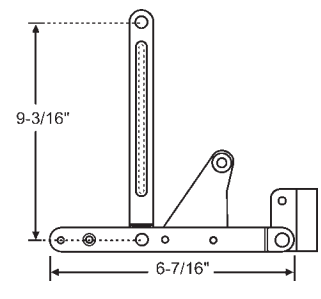

Part #	Hand
28-83RH	Shown
28-83LH	Opposite

Egress Bottom Hinge Assembly  
**PEACHTREE**

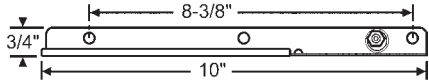

Part #	Hand
28-01-10ARH	Shown
28-01-10ALH	Opposite

Casement Hinge Track

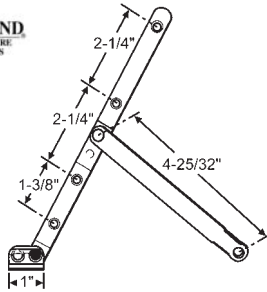

Part #	Hand
28-03-10RHA	Shown
28-03-10LHA	Opposite

Casement Hinge Arm

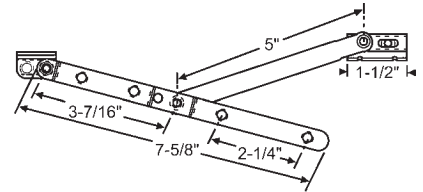

**28-120NSA**  
Casement Hinge Set  
**BILTBEST**

## SASH CONTROL DEVICES

### TRUTH'S HEAVY DUTY FRICTION ADJUSTERS

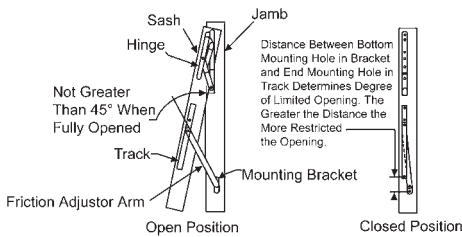

### TRUTH'S STANDARD DUTY FRICTION ADJUSTERS ANDERBERG FA22SS SERIES

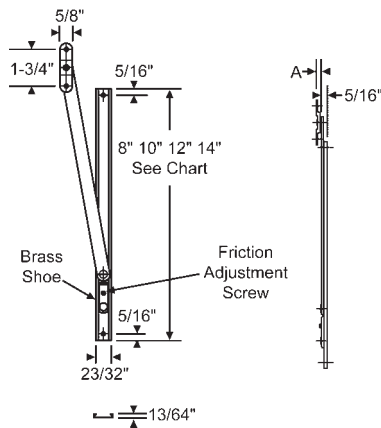

Truth Part #	Our Part #	Track Length	"A" Dimension
37.35.00.100	28-8-9-00	8"	15/64" (.235)
37.36.00.100	28-10-9-00	10"	15/64" (.235)
37.37.00.100	28-12-9-00	12"	15/64" (.235)
37.38.00.100	28-14-9-00	14"	15/64" (.235)

Note: Bar length is always 2" shorter than track length.

### TRUTH'S HEAVY DUTY FRICTION ADJUSTERS ANDERBERG FA33SS SERIES

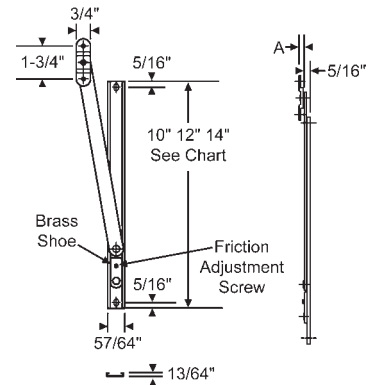

Truth Part #	Our Part #	Track Length	"A" Dimension
37.41.00.100	28-10-10-0	10"	15/64" (.235)
37.42.00.100	28-12-10-0	12"	15/64" (.235)
37.43.00.100	28-14-10-0	14"	15/64" (.235)

Note: Bar length is always 2" shorter than track length. Must specify bracket height from chart if not a standard bracket. Please contact Account Manager for correct part number.



# WINDOW REPLACEMENT HARDWARE

## SASH CONTROL DEVICES

### TRUTH'S STANDARD DUTY LIMIT DEVICE WITH KEY RELEASE - ANDERBERG FA220SS SERIES

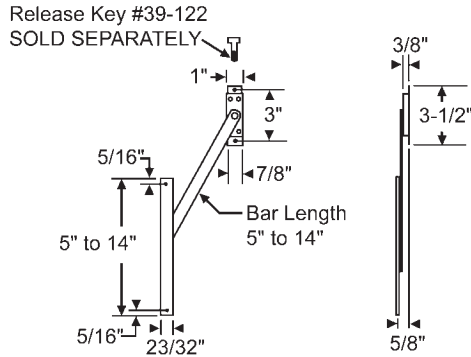

Truth Part #	Our Part #	Track Length	Bar Length
37.26.00.100	28-5-11-0	5"	5"
37.27.00.100	28-6-11-0	6"	6"
37.28.00.100	28-7-11-0	7"	7"
37.29.00.100	28-8-11-0	8"	8"
37.31.00.100	28A-10-11-0	10"	8"
37.31.00.101	28-10-11-0	10"	10"
37.33.00.100	28B-12-10-0	12"	6"
37.33.00.101	28B-12-11-0	12"	10"
37.33.00.102	28-12-11-0	12"	12"
37.34.00.101	28-14-11-0	14"	14"

Note: If a bracket is not specified it comes with the standard 15/64" bracket (.235).



99.20 Limit Device  
99.24 Stainless Steel  
Limit Device

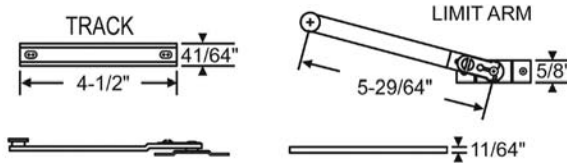

Part #	Description
39-167	5" Limit Device (Arm Only)
39-167SS	Stainless Steel 5" Limit Device (Arm Only)
39-481	Track Only
39-482	Arm & Track Assembly
39-482SS	Stainless Steel Arm & Track Assembly

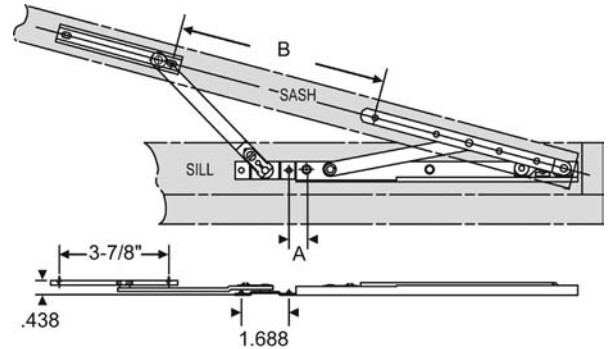

### TRUTH SUPPORT ARMS - ANDERBERG 88SS SERIES

#### APPLICATION OF TRUTH'S SUPPORT ARMS

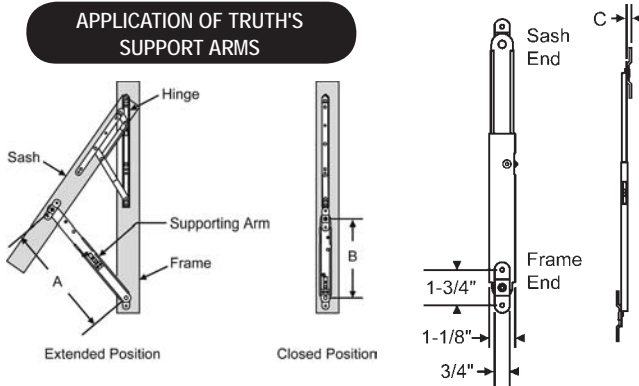

Truth Part #	Part #	A	B	Description (C)
37.10.00.100	28-10-7-01	10"	7"	with two .110 Brackets
37.10.00.103	28-10-7-07	10"	7"	with two .235 Brackets
37.11.00.104	28-12-7-01	12"	8"	with two .110 Brackets
37.11.00.102	28-12-7-07	12"	8"	with two .235 Brackets
37.12.00.100	28-14-7-01	14"	9"	with two .110 Brackets
37.13.00.106	28-16-7-01	16"	10"	with two .110 Brackets
37.13.00.103	28-16-7-07	16"	10"	with two .235 Brackets
37.14.00.100	28-18-7-01	18"	11"	with two .110 Brackets
37.15.00.102	28-20-7-01	20"	12"	with two .110 Brackets
37.16.00.302	28-22-7-07	22"	13"	with two .235 Brackets
37.17.00.105	28-24-7-01	24"	14"	with two .110 Brackets
37.18.00.101	28-26-7-01	26"	15"	with two .110 Brackets

Other lengths and bracket attachments available.  
Contact your Sales Representative for details.

### TRUTH SUPPORT ARMS WITH LIMIT DEVICE - ANDERBERG 880SS SERIES

#### APPLICATION OF TRUTH'S SUPPORT ARMS

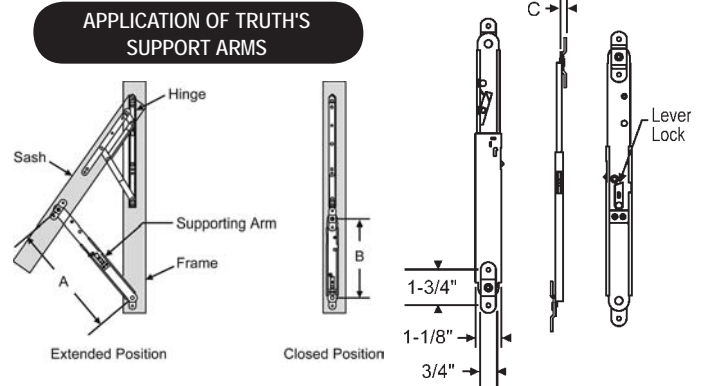

To Extend, #39-121  
Release Key is Needed.  
Sold Separately

Truth Part #	Part #	Support Arm	Description (C)
37.20.00.100	28-12-8-01	12"	with two .110 Brackets
37.21.00.103	28-16-8-01	16"	with two .110 Brackets
37.21.00.110	28-16-8-04	16"	with two .180 Brackets
37.22.00.100	28-20-8-01	20"	with two .110 Brackets
37.23.00.114	28-24-8-01	24"	with two .110 Brackets
37.23.00.113	28-24-8-04	24"	with two .180 Brackets
37.24.00.107	28-28-8-02	28"	with two .180 Brackets

Other lengths and bracket attachments available.  
Contact your Sales Representative for details.

# WINDOW REPLACEMENT HARDWARE

## TOP HUNG HINGE ASSEMBLY

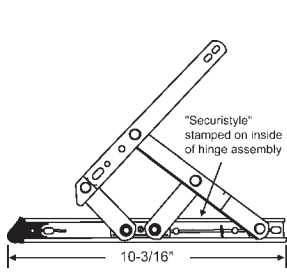

### 28-93-10

10" Storm Hinge (Pair). Stack Height 5/8".  
RH Shown. Stainless Steel  
**SECURISTYLE**

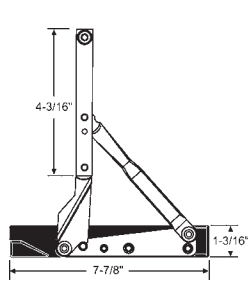

### 28-135C

Friction Hinge Set. RH Shown.  
Stainless Steel.  
**CERTAINTEED INSULATE**

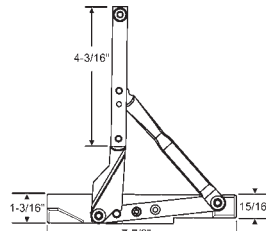

Part #	Hand
28-135AR	Shown
28-135AL	Opposite

Friction Hinge. Stainless Steel.  
**ANDERSEN RENEWAL**

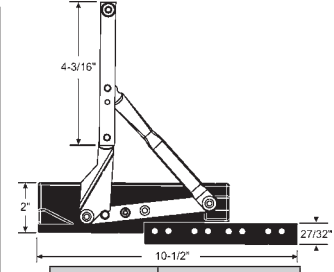

Part #	Hand
28-135ML	Shown
28-135MR	Opposite

Stainless Steel.  
**MILGARD**

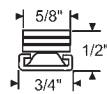
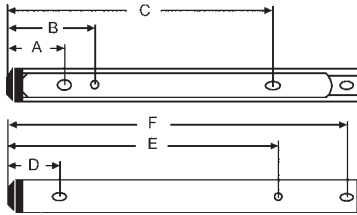

Part No.	Size	Recommended Maximum Sash		
		Width	Height	Weight in lbs.
900-21941-16	16"	47-1/4"	29-1/2"	48.5

Fixing Hole Details in Millimeters						
Size	A	B	C	D	E	F
16"	36.1	139	271.9	30.8	309	407.2

**G-U HARDWARE**

## MISCELLANEOUS OPERATOR HARDWARE

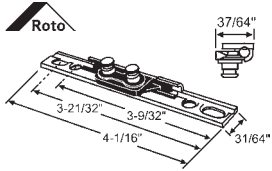

### 39-692

Surface Mount Awning Bracket  
Assembly.

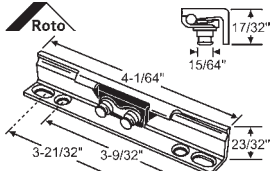

### 39-691

Face Mount Awning Bracket  
Assembly.

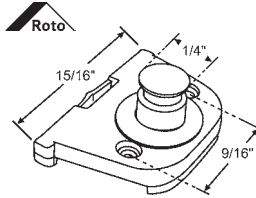

### 39-753

Slider for 38-21 Track

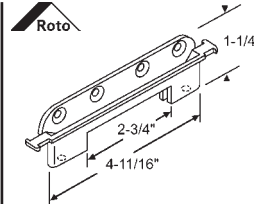

### 39-351

Use: 39-614

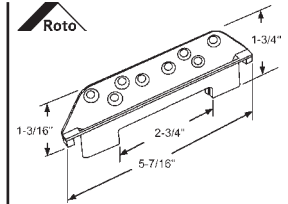

### 39-614

Die Cast Wittman Counterpart  
Spacer. Replaces Old  
Spacer 39-351

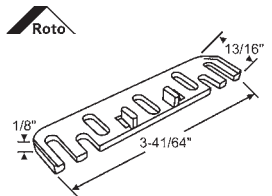

### 39-665

Black Nylon Spacer for Pro-Drive  
Operator

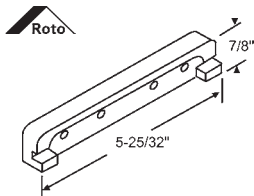

Part #	Color
39-350W	White

Plastic Support

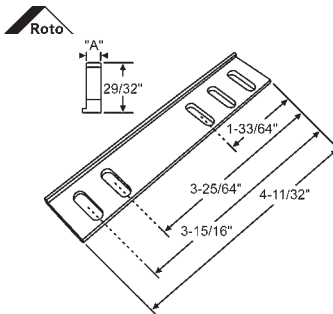

Part #	"A"
39-687	3/32"
39-687A	11/64"
39-687B	1/4"
39-687C	21/64"
39-687D	13/32"

Operator Bottom Spacer.  
Black

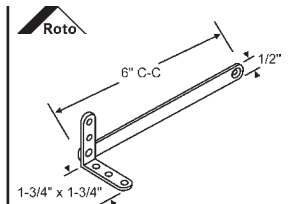

### 39-352

Connecting Arm with Bracket for  
36-333 and 36-334.  
Zinc Dichromate

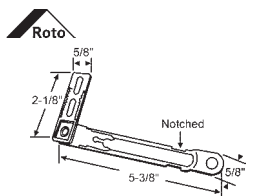

### 39-497

Stainless Steel Connect Arm with  
Die Cast Bracket.

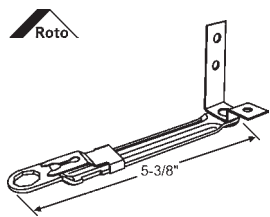

### 39-794

Stainless Steel Connect  
Arm Assembly with Stainless  
Steel Bracket

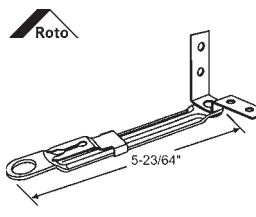

### 39-817

Stainless Steel Connect  
Arm Assembly with Stainless  
Steel Bracket

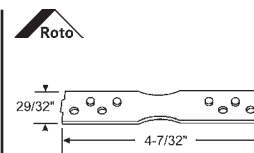

### 39-602

4-1/8" Black Top Spacer  
3.5mm Thick x 22.5mm High

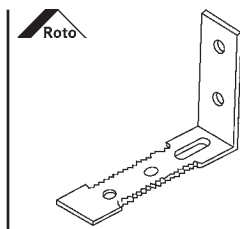

### 39-575

Sash Adapter Bracket for  
Casement Window. Stainless Steel

# WINDOW REPLACEMENT HARDWARE

## MISCELLANEOUS

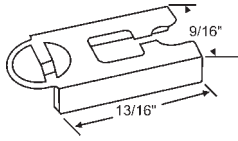

**39-207**  
Detach Clip Bracket

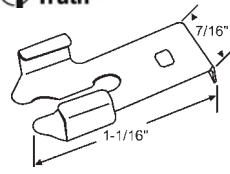

**39-323**  
Stainless Steel Detach Clip

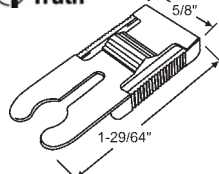

**39-758**  
Black Plastic Detach Clip

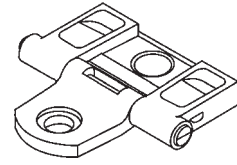

**39-379**  
Pivot Shoe Assembly

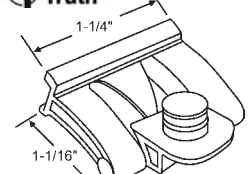

**39-441**  
Pivot Slide Assembly  
Black, Plastic

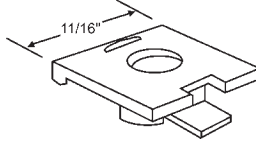

**39-469**  
Black Casement Slider

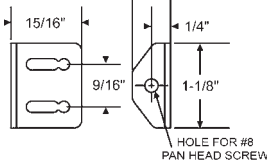

Part #	Finish
39-738-3	White
39-738-8	Chestnut Bronze

Stabilizing Tab. Includes 2 screws for attachment to operator.

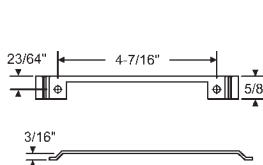

**39-763**  
Maxim® Dual Arm Operator Back Plate

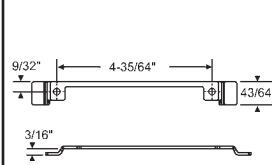

**39-733**  
Encore™ Dyad Operator Back Plate

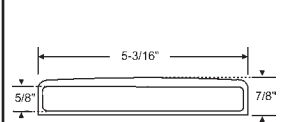

**39-417**  
Gasket for Maxim Operator

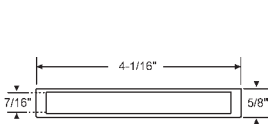

**39-512**  
Gasket for Traditional Operator

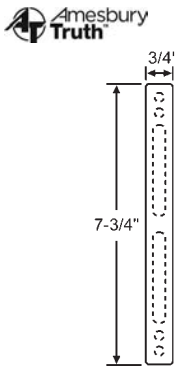

**39-44**  
Operator Gasket

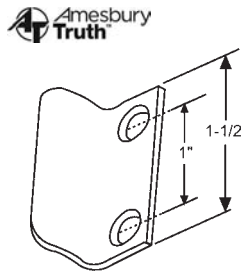

Part #	Finish
39-112	E-Gard Finish
39-112-3	White

Side Jam Snubber

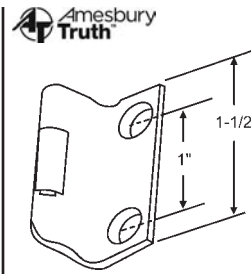

Part #	Finish
39-114-9	Beige
39-114-14	Cocoa Brown
39-114-23	Sandstone

Side Jam Snubber with Vinyl Insert

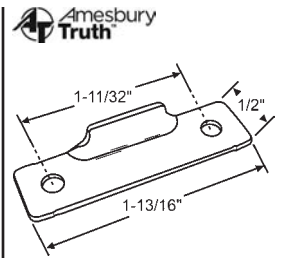

Part #	Finish
39-303	E-Gard

Concealed Snubber

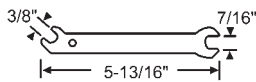

**39-462**  
Combo Stud Wrench

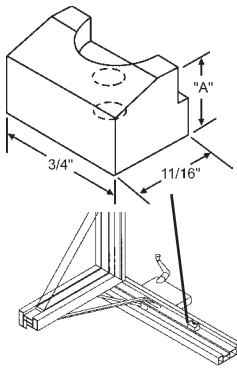

Part #	Description	"A"
39-519	Clear Plastic	7/16"
39-519W	White	7/16"
39-520	Clear Plastic	1/2"
39-437	White	1/2"

Casement Ramp  
**ACORN**

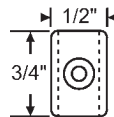

**39-611**  
Slide Block  
White  
**SILVERLINE**

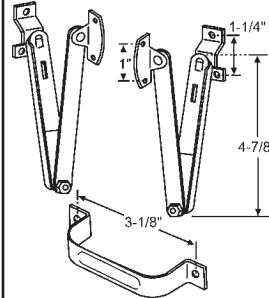

**900-15453**  
Storm Window Adjuster - Pair  
Locks window securely when closed.

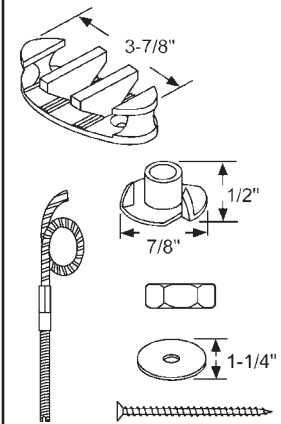

**900-22378**  
Window Cable Support Kit for Bay Window

# WINDOW REPLACEMENT HARDWARE

## FINGER LATCHES & SLIDE BOLTS

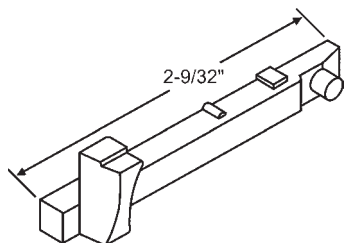

Part #	Hand
900-5736	Shown
900-5735	Opposite

Slide Bolt. Natural Nylon  
**NEWELL**

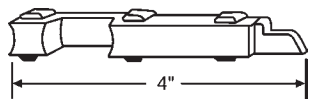

### 46-15A

Slide Bolt Set (LH/RH)  
Natural Nylon

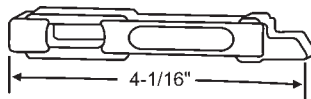

Part #	Finish
46-2A	Mill
46-2WA	White
46-2BA	Brown

Die Cast Set (LH/RH)  
**CAPITOL**

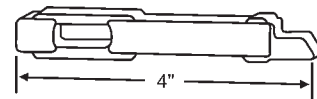

### 46-23A

Natural Nylon Set (LH/RH)

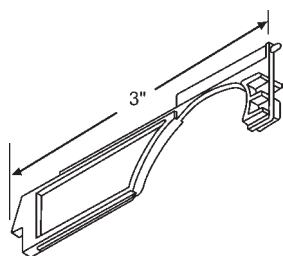

**46-30**  
Die Cast

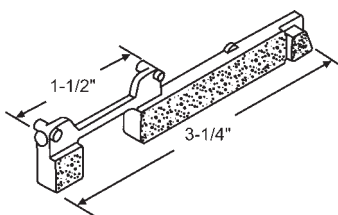

Part #	Hand
46-32	Shown
46-31	Opposite

Die Cast

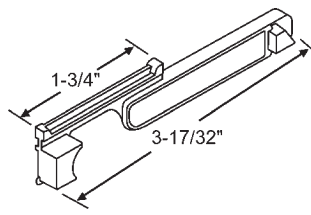

Part #	Hand
46-39	Shown
46-40	Opposite

Die Cast

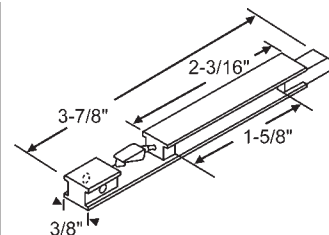

### 46-50A

LH/RH Slide Bolt. Sold in Set (RH Shown)  
White Nylon

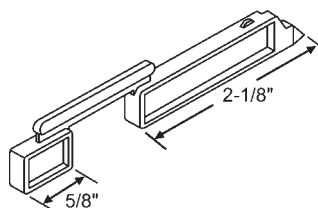

Part #	Hand
46-52	Shown
46-53	Opposite

Natural Nylon

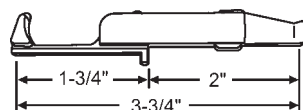

Part #	Hand
900-18534LH	Shown
900-18534RH	Opposite

Die Cast

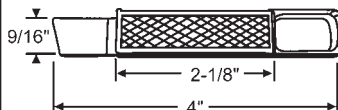

Part #	Hand
900-13501LH	Shown
900-13501RH	Opposite

Bright Zinc, Die Cast

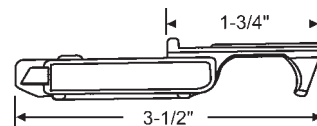

Part #	Hand
900-11890	Shown
900-11891	Opposite

Die Cast

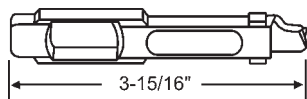

Part #	Hand
900-11877	Shown
900-11878	Opposite

Die Cast  
**SEASONALL**

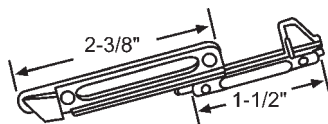

Part #	Hand
900-22011LH	Shown
900-22011RH	Opposite

Die Cast

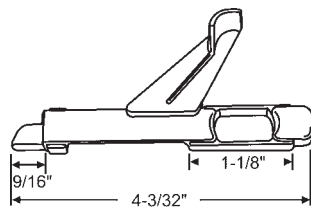

Part #	Hand
900-9297	Shown
900-9298	Opposite

Die Cast  
**CAPITOL**

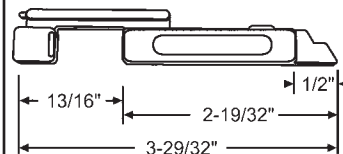

**900-12146A**  
Natural Nylon Set (LH/RH)

# WINDOW REPLACEMENT HARDWARE

## FINGER LATCHES & SLIDE BOLTS

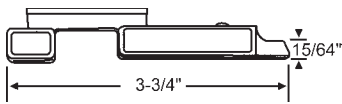

Part #	Hand
46-164LH	Opposite
46-164RH	Shown

White Nylon

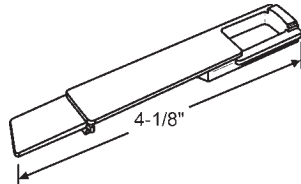

Part #	Hand
900-19289LH	Shown
900-19289RH	Opposite

White Nylon

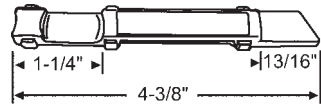

Part #	Hand
900-18849	Shown
900-18850	Opposite

Die Cast

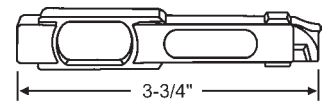

Part #	Hand
900-10187LH	Opposite
900-10187RH	Shown

Die Cast

**SEASONALL**

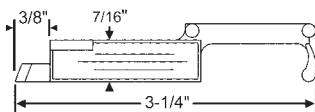

Part #	Hand
900-18535LH	Shown
900-18535RH	Opposite

Die Cast

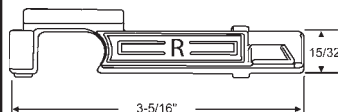

Part #	Hand
46-4	Shown
46-5	Opposite

Die Cast

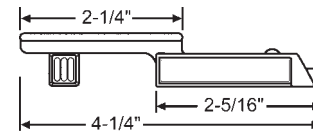

**46-358P**

Slide Bolt Set (LH/RH). RH Shown. White Plastic.

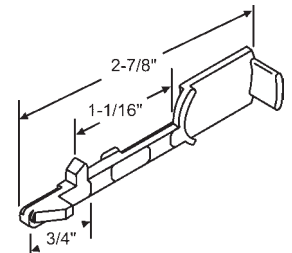

Part #	Hand
900-445LH	Shown
900-445RH	Opposite

Die Cast

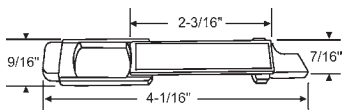

**900-17495**  
Die Cast Set (RH/LH) with Springs  
RH Shown  
**TRACO**

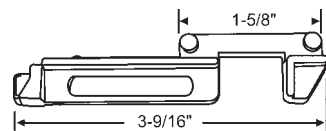

Part #	Hand
900-12610LH	Shown
900-12610RH	Opposite

Die Cast

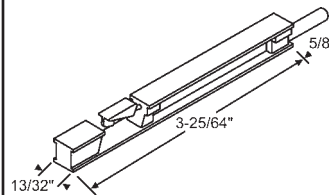

Part #	Finish
900-1725	Natural Nylon

Natural Nylon, Non-Hand

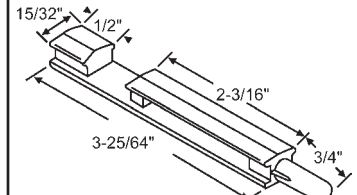

Part #	Finish
46-280W	White
46-280BG	Beige

Nylon, Non-Hand

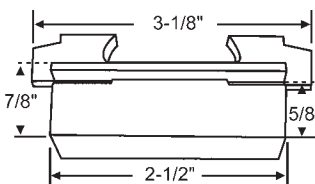

**46-122**  
Black, Plastic

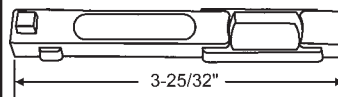

Part #	Hand
46-118	Shown
46-119	Opposite

Die Cast

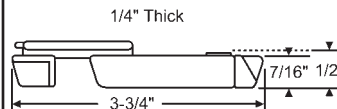

Part #	Hand
900-1655	Shown

Natural Nylon

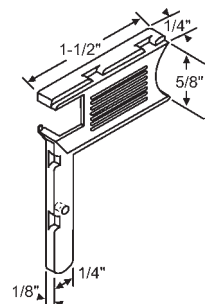

Part #	Hand
900-9229RH	Shown
900-9229LH	Opposite

Die Cast

# WINDOW REPLACEMENT HARDWARE

## FINGER LATCHES & SLIDE BOLTS

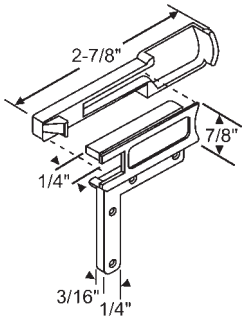

**46-33A**  
Die Cast  
Sold in Sets Only

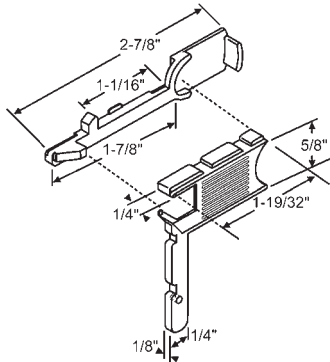

**900-1831BA**  
Plastic Slide Bolt Black  
Sold in Sets Only

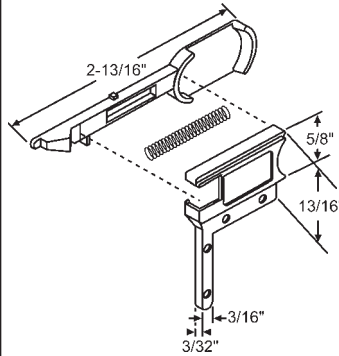

Part #	Hand
900-18624RHN	Shown
900-18624LHN	Opposite

Die Cast Slide Bolt. Black

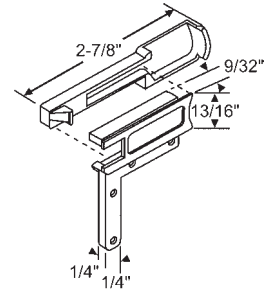

**46-35A**  
Finger Latch Set (LH/RH)  
Die Cast

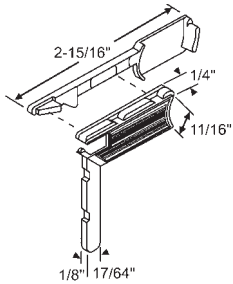

Part #	Hand
46-37	Shown
46-38	Opposite

Die Cast

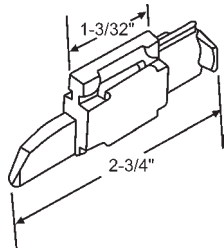

Part #	Hand
900-13382LH	Shown
900-13382RH	Opposite

Die Cast

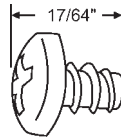

**900-13382S**  
Screw for 900-13382LH/RH

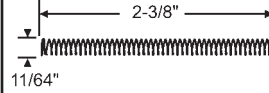

**900-13382SP**  
Spring for 900-13382LH/RH

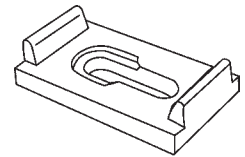

**900-13382L**  
Limit Stop for 900-13382LH &  
900-13382RH. Black

## SLIDE BOLT ACCESSORIES

## SLIDE BOLT SPRINGS

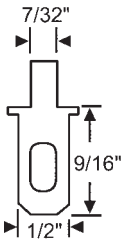

**900-13382R**  
Spring Retainer  
Zinc

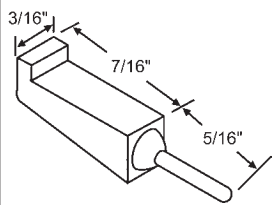

**900-5732**  
Natural Nylon Spring Insert for  
900-5735 Slide  
Bolts/Finger Latch

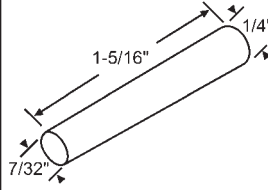

**900-17455**  
Storm Slide Bolt Extension  
Natural Nylon

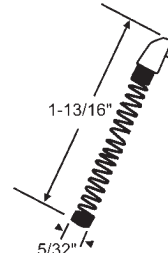

**46-10**  
Plastic Tip

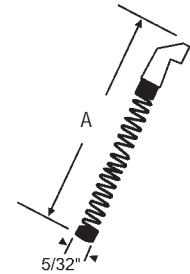

Part #	A
46-28	1-63/64
46-28S	1-5/16"

Plastic Tip

## ANTI-BOW PIN

## INSERT CLIPS

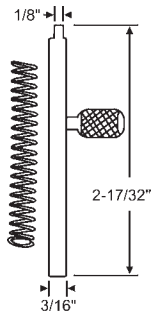

**900-9573**  
Latch Pin Bar with Spring  
Aluminum

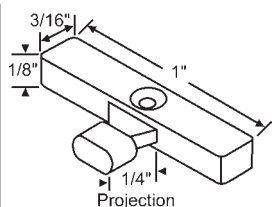

**900-11894**  
Anti-Bow Pin  
Die Cast

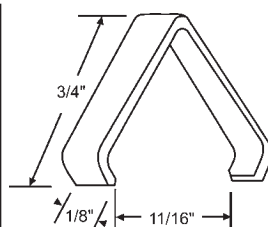

**46-1**

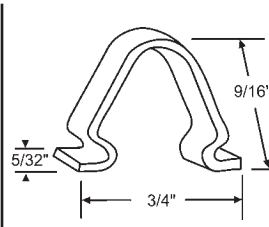

**46-6**

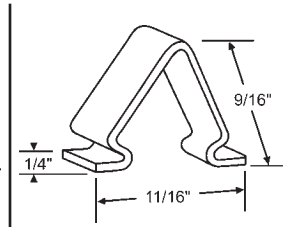

**46-22**

# WINDOW REPLACEMENT HARDWARE

## INSERT CLIPS

## CORNER KEYS

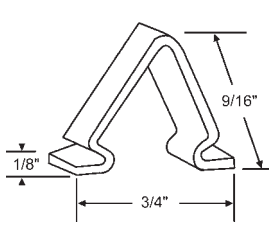

**46-126**

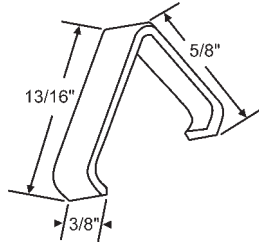

**46-218**

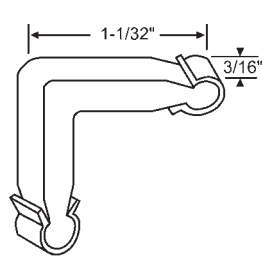

**46-11**  
Universal. Die Cast

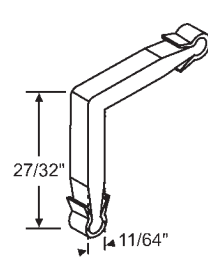

**46-124**  
Die Cast

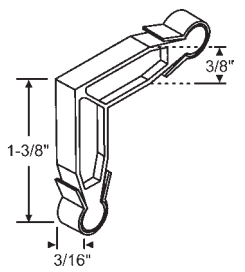

**900-17541**  
Die Cast

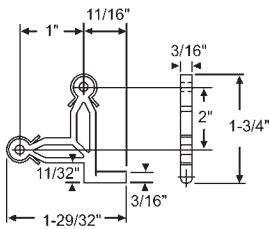

**900-17541T**  
Tilt Window Screen Corner  
Die Cast  
**TRACO**

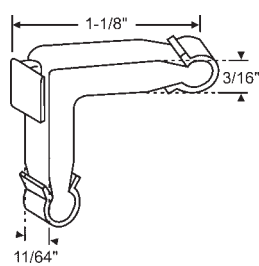

**46-9**  
Die Cast  
**CAPITOL**

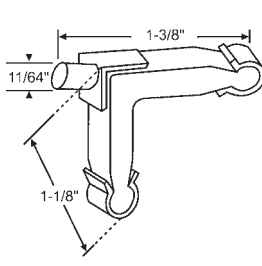

**46-8**  
Die Cast  
**CAPITOL**

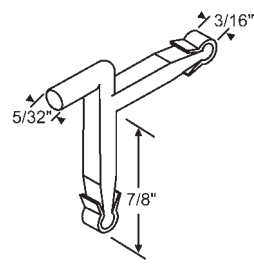

**46-125**  
Die Cast

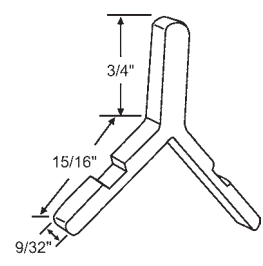

**46-21**  
Aluminum

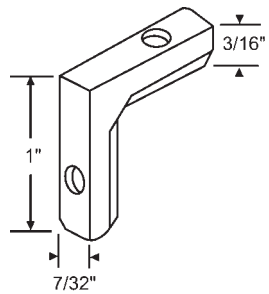

**46-12**  
Die Cast

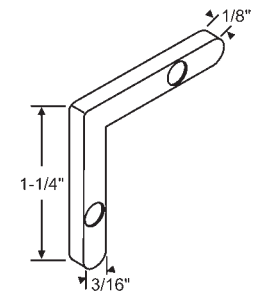

**900-479**  
Die Cast

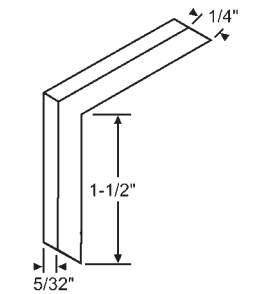

**900-14556**  
Aluminum

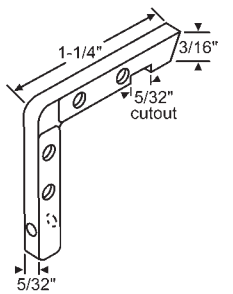

**900-11892**  
Die Cast

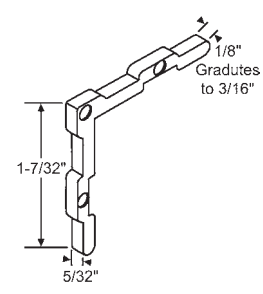

**900-11008**  
Die Cast

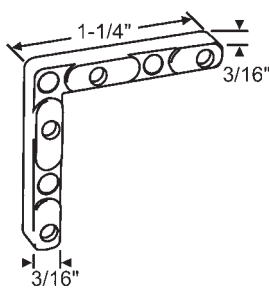

**900-481**  
Die Cast

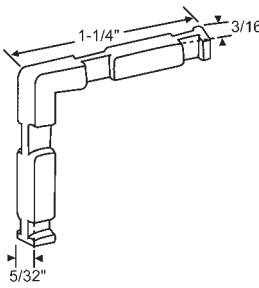

**46-66**  
Die Cast

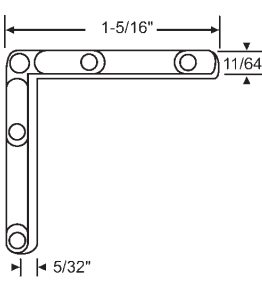

**900-15214**  
Die Cast

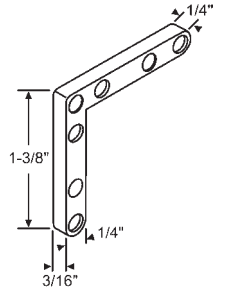

**900-12611**  
Die Cast

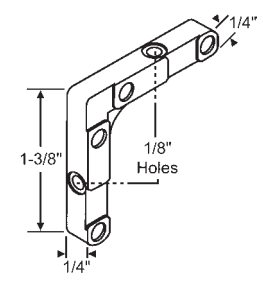

**900-14537**  
Die Cast

# WINDOW REPLACEMENT HARDWARE

## CORNER KEYS

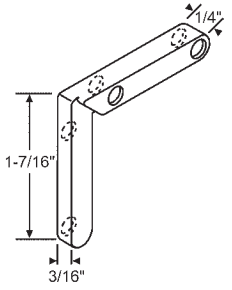

Part #	Hand
900-12612LH	Shown
900-12612RH	Opposite

Die Cast

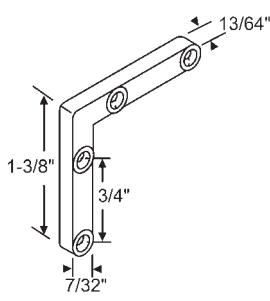

**900-21287**  
Die Cast

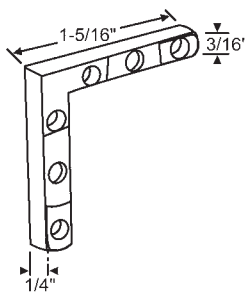

**46-86**  
Die Cast

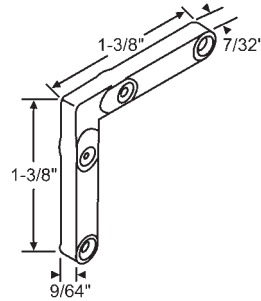

**46-80**  
Die Cast

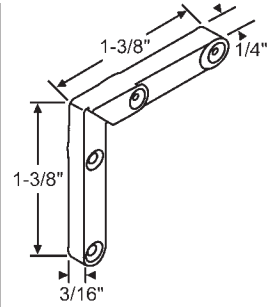

**46-82A**  
Sold in Sets Only  
LH Shown. Die Cast

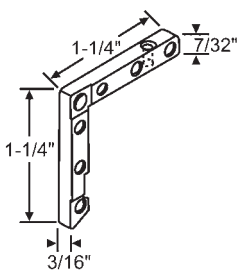

**46-120**  
Die Cast

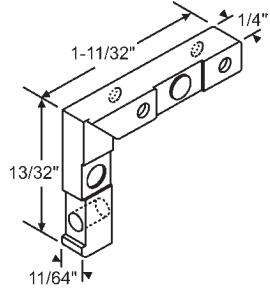

Part #	Hand
900-19065	Shown
900-19066	Opposite

Die Cast

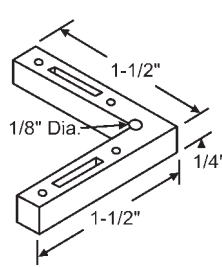

**900-7303**  
Natural Nylon  
**CROSSLY**

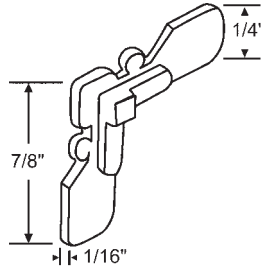

**46-25**  
Die Cast

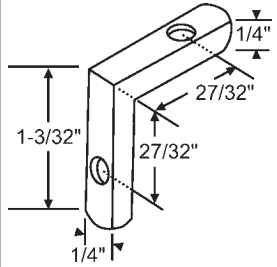

**46-263**  
Zinc Die Cast  
**HARCAR**

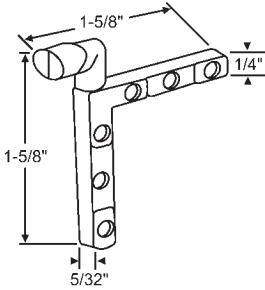

**46-27A**  
Die Cast  
Sold in Sets Only  
1RH (Shown) & LH

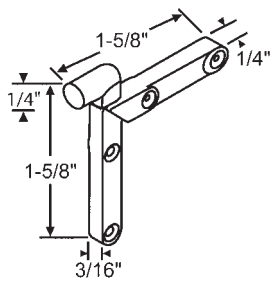

Part #	Hand
46-85	Shown
46-84	Opposite

Die Cast

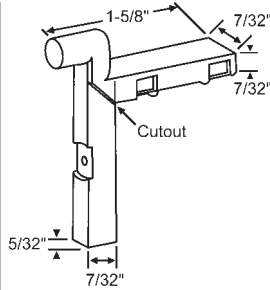

Part #	Hand
46-90	Shown
46-89	Opposite

Die Cast

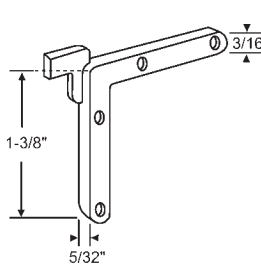

**46-7**  
Die Cast

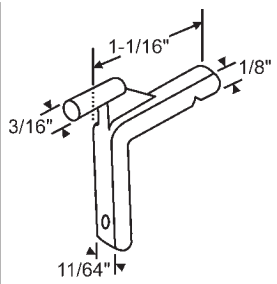

**46-142**  
Die Cast  
With Hole & Screw

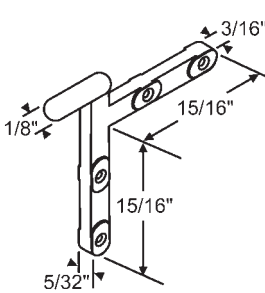

**900-18318**  
Corner Key  
Die Cast

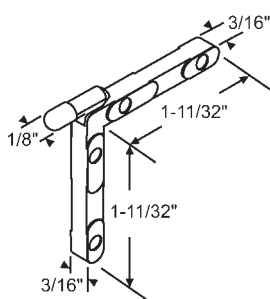

**900-464**  
Die Cast

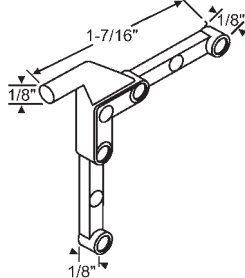

Part #	Hand
900-17595LH	Shown
900-17595RH	Opposite

Die Cast Corner Swivel

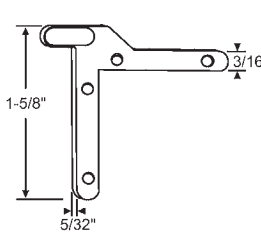

**900-11012**  
Corner Key Pair (LH/RH)  
Die Cast

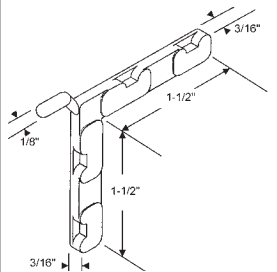

Part #	Hand
900-11924LH	Shown
900-11924RH	Opposite

Die Cast



# WINDOW REPLACEMENT HARDWARE

## CORNER KEYS

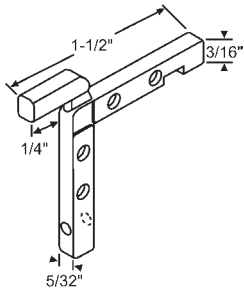

**900-11893**  
Die Cast

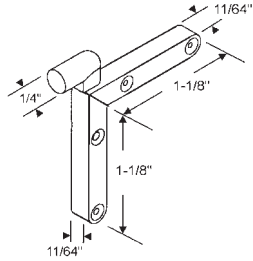

Part #	Hand
900-12613LH	Shown
900-12613RH	Opposite

Die Cast

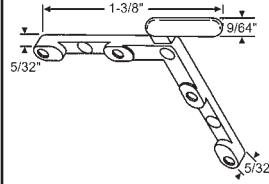

**900-19063**  
Die Cast

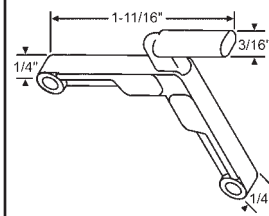

**900-19067**  
Die Cast, Gray

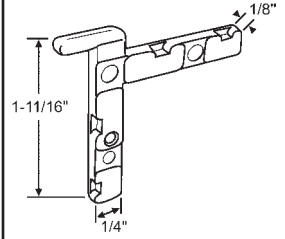

Part #	Hand
900-456LH	Shown
900-456RH	Opposite

Die Cast Tilt Key

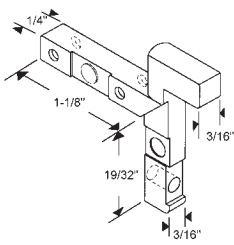

**900-19068**  
Die Cast

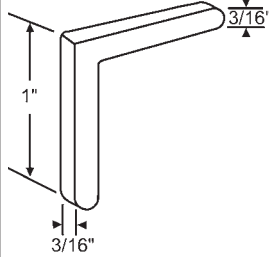

**46-19**  
Natural Nylon

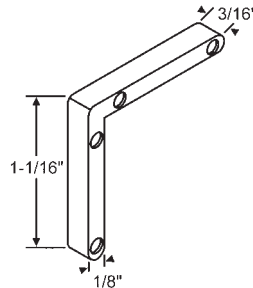

**46-121**  
Natural Nylon  
**SEASONALL**

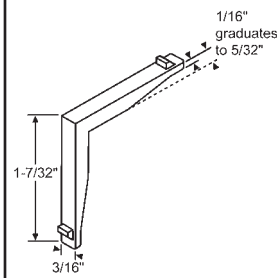

**46-138**  
White Nylon

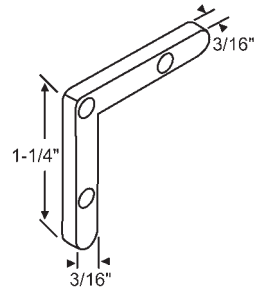

**900-2229**  
Universal  
Natural Nylon

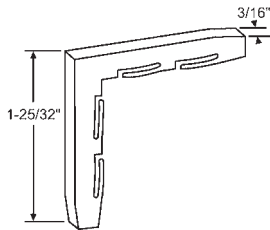

**900-19237**  
White  
Plastic

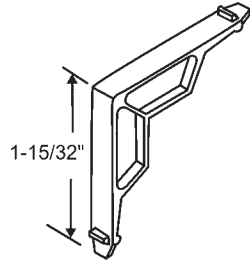

**900-2251**  
Natural Nylon

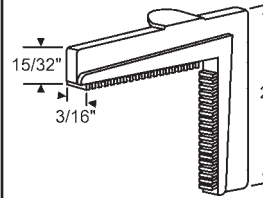

Part #	Hand
900-2256	Shown
900-2257	Opposite

White Nylon

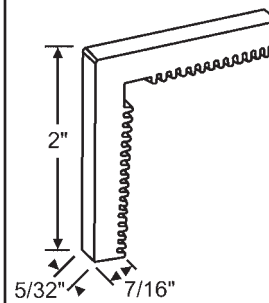

**900-2260**  
White

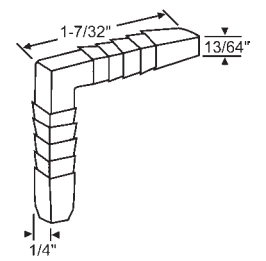

**900-2278**  
Natural Nylon

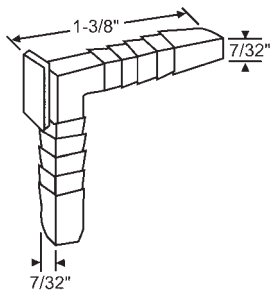

**46-20**  
Universal  
White Nylon

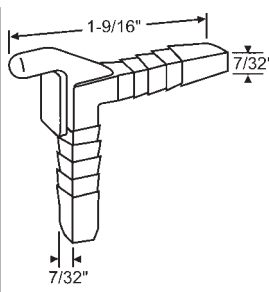

**46-26**  
Natural Nylon

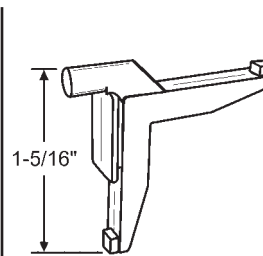

**900-9071**  
White  
**CAREFREE**

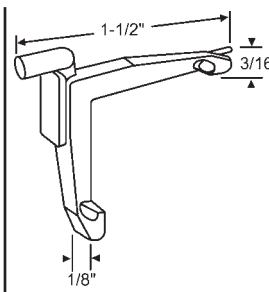

**46-17**  
Universal  
Natural Nylon

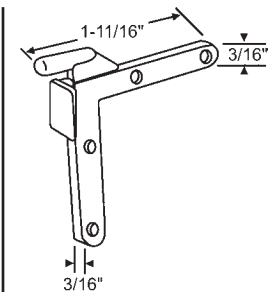

**46-18B**  
Nylon  
Black

# WINDOW REPLACEMENT HARDWARE

## CORNER KEYS, TILT KEYS

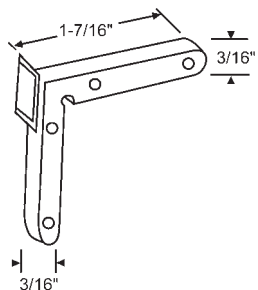

**900-2209**  
Universal  
Natural Nylon

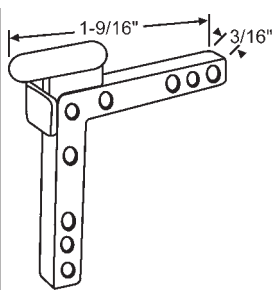

**46-163**  
White Nylon Tilt Key

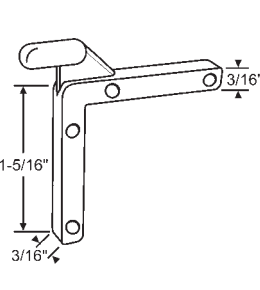

**46-285**  
Universal  
White Nylon

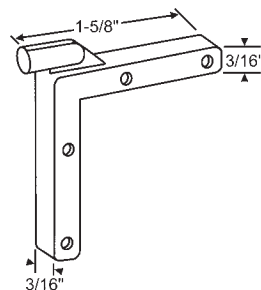

**900-2157**  
Natural Nylon Tilt Key

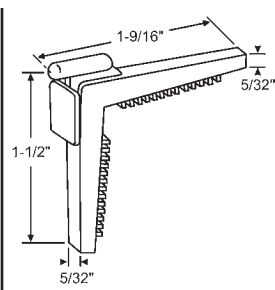

**900-2269**  
Black Nylon Tilt Key

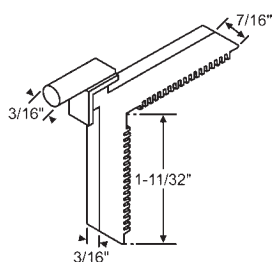

**900-15773**  
Natural Nylon Tilt Corner Key

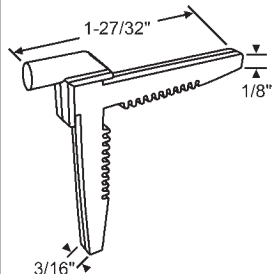

**46-107**  
White Nylon. Saw Tooth Design

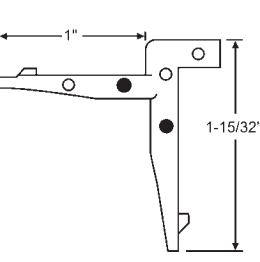

**46-137**  
White Nylon with Edge

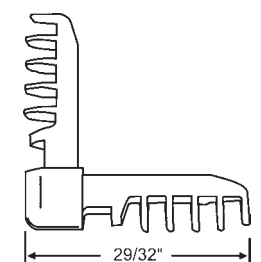

**46-269**  
White Nylon

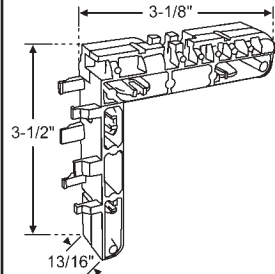

**900-19043**  
White Nylon

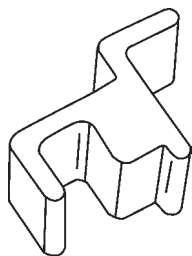

**900-21654**  
Storm Sash Control Button  
Die Cast

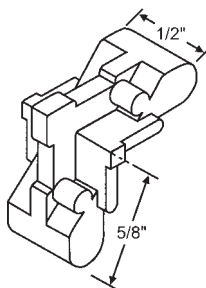

**900-14559**  
Die Cast

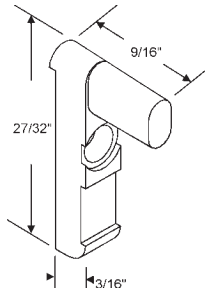

**900-10188**  
Pivot Key without Screw  
Die Cast

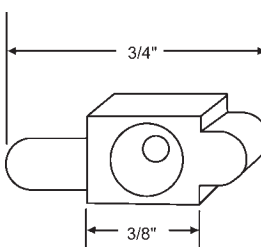

**900-5359**  
Tilt Key, Nylon  
Black  
**ALENCO**

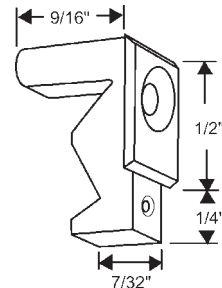

**900-5941**  
Natural Nylon Tilt Key

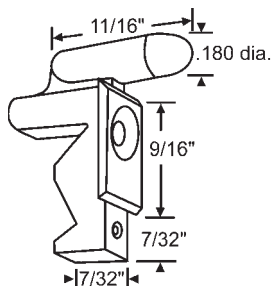

**900-5939**  
Black Nylon Tilt Key  
**GALLITAN**

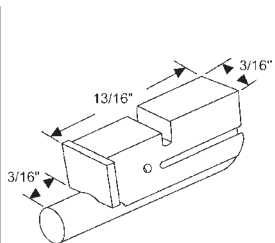

**900-2353**  
Tilt Key  
White Nylon

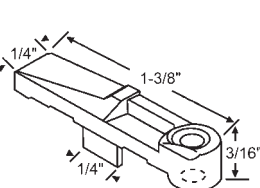

Part #	Hand
900-12102	Shown
900-12101	Opposite

Die Cast. Storm Window &  
Door Anti-Bow Latch For Wood  
Windows  
**SEASONALL**

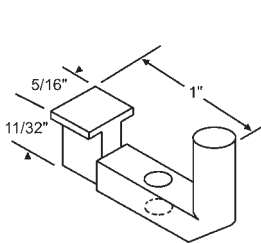

**46-116**  
White  
Nylon Tilt Key  
**SUGARCREEK**

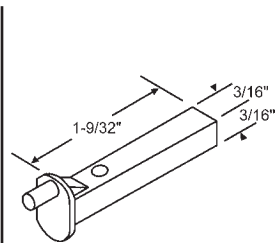

**900-2331**  
Natural Nylon Tilt Key

### C-Sash Components Make Assembly and Installation Easy.

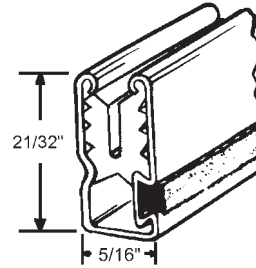
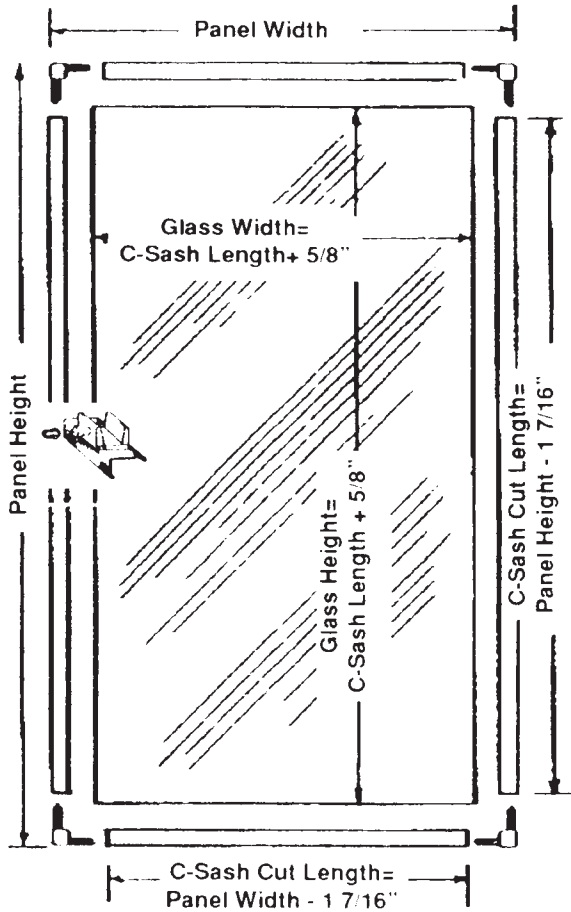

8 Ft. Lengths - 20 lengths per carton

Part #	Color
90-496W-8	White

12 Ft. Lengths - 100 lengths per carton

Part #	Color
90-492M-12	Mill
90-492B-12	Bronze
90-492W-12	White

**Press-Lock™** Corners eliminate the need for mitering. Just push into a square-cut corner, no need for staking. Made of high-impact ABS.

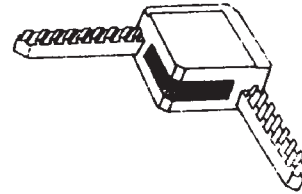

Part #	Color
90-489M	Mill
90-489B	Bronze
90-489W	White

**Sill Expander** A vinyl section which includes pile weather-strip, slides onto the C-sash frame to correct for sill irregularities and to provide weather-scaling along the base of frame.



Part #	Color
90-491B	Bronze
90-491W	White

42" Length

C-Sash® has been a proven performer in the storm window and storm door industry for years. Its unique roll-formed combination of aluminum, gasketing and weather-stripping reduce fabrication time and simplify inventory control. This reliable framing member can be used for:

- External Storm Panels
- Internal Window Panels
- Additional Thermal Protection for
- Picture and Bay Windows
- Storm Door Window Panels
- Up to 1/8" Glass Thickness

\*Note C-Sash cut lengths = Panel Width - 5/8"

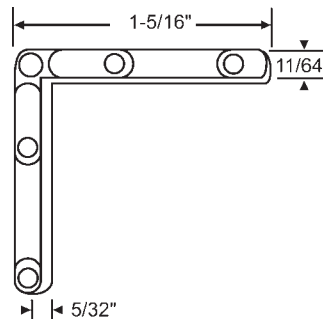

**Die Cast Corner Key** Zinc Die Cast used for mitered corners.

**900-15214**

# RV & MOBILE HOME HARDWARE

## CRANKS, KNOBS, HANDLES AND EXTENSIONS

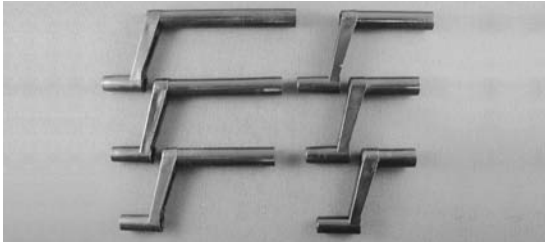

Black Plastic Crank Handle w/Screw  
1 Per Card

Part #	Description
838C BLK	1" Plastic Crank
748C BLK	1-3/8" Plastic Crank
881C BLK	1-3/4" Plastic Crank
750C BLK	2-1/4" Plastic Crank
771C BLK	2-1/2" Plastic Crank
712C BLK	3-3/16" Plastic Crank

Black Plastic Crank Handle w/Screw  
25 Polybagged

Part #	Description
838P BLK	1" Plastic Crank
748P BLK	1-3/8" Plastic Crank
881P BLK	1-3/4" Plastic Crank
750P BLK	2-1/4" Plastic Crank
771P BLK	2-1/2" Plastic Crank
712P BLK	3-3/16" Plastic Crank

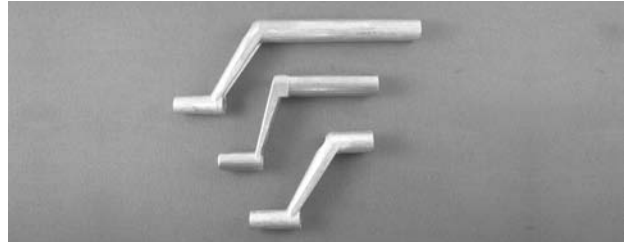

Metal Crank Handle w/Screw  
1 Per Card

Part #	Description
889C	1" Metal Crank
795C	1-3/4" Metal Crank
796C	3-1/2" Metal Crank

Metal Crank Handle w/Screw  
25 Polybagged

Part #	Description
889P	1" Metal Crank
795P	1-3/4" Metal Crank
796P	3-1/2" Metal Crank



2-1/4" Outside Diameter Black Plastic Knob Handle w/Screw  
1 Per Card

Part #	Description
743C BLK	5/16" Shaft
743CE BLK	7/8" Shaft

25 Polybagged

Part #	Description
743P BLK	5/16" Shaft
743PE BLK	7/8" Shaft

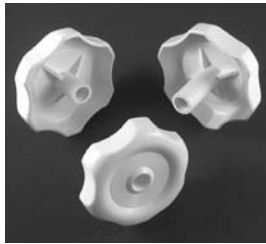

2-1/4" Outside Diameter White Plastic Knob Handle w/Screw  
1 Per Card

Part #	Description
743C WHT	5/16" Shaft
743CE WHT	7/8" Shaft

25 Polybagged

Part #	Description
743P WHT	5/16" Shaft
743PE WHT	7/8" Shaft



2-1/8" Outside Diameter White Plastic Kinro Knob Handle w/Screw  
1 Per Card

Part #	Description
710C WHT	9/16" Shaft
710CE WHT	13/16" Shaft

Bulk

Part #	Description
710P WHT	9/16" Shaft
710PE WHT	13/16" Shaft



2-1/8" Outside Diameter Black Plastic Kinro Knob Handle w/Screw  
1 Per Card

Part #	Description
710C BLK	9/16" Shaft
710CE BLK	13/16" Shaft

1 Polybagged

Part #	Description
710P BLK	9/16" Shaft
710PE BLK	13/16" Shaft



1-5/8" Outside Diameter Mini Black Plastic Knob Handle w/Screw  
1 Per Card

Part #	Description
713C BLK	9/16" Shaft

1 Polybagged

Part #	Description
713P BLK	9/16" Shaft



Plastic Tee Handle w/Screw  
1 Per Card

Part #	Description
837C	13/16" Shaft

25 Polybagged

Part #	Description
837P	13/16" Shaft



Metal Tee Handle w/Screw  
1 Per Card

Part #	Description
776C	1/2" Shaft

10 Polybagged

Part #	Description
776P	1/2" Shaft

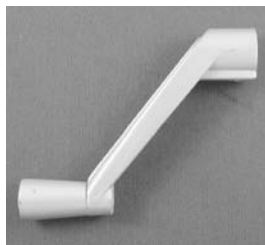

Metal Crank Handle  
1 Per Card

Part #	Description
155C	5/16" Hex

1 Polybagged

Part #	Description
37-159	5/16" Hex



Roof Vent Crank Handle w/Screw  
1 Per Card

Part #	Description
783C	1/4" Shaft

1 Polybagged

Part #	Description
783P	1/4" Shaft

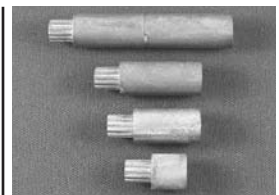

Metal Extension w/Screw  
1 Per Card

Part #	Description
831C	1/2" Metal Extension
832C	7/8" Metal Extension
833C	1-1/8" Metal Extension
834C	2" Metal Extension

25 Polybagged

Part #	Description
831P	1/2" Metal Extension
832P	7/8" Metal Extension
833P	1-1/8" Metal Extension
834P	2" Metal Extension

## OPERATORS AND OPERATOR KITS

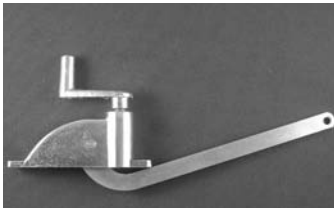

**Roof Vent Operator Kit**  
2-15/16" cc Mounting Holes  
1 Kit Per Card

Part #	Description
898CK	5" Arm
806CK	5-3/8" Arm
807CK	7-11/16" Arm

1 Kit Polybagged

Part #	Description
898PK	5" Arm
806PK	5-3/8" Arm
807PK	7-11/16" Arm

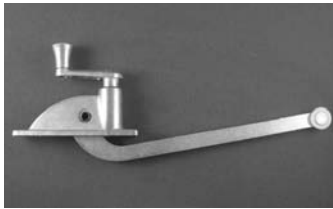

**Roof Vent Operator Kit**  
2-15/16" cc Mounting Holes.  
1 Kit Per Card

Part #	Description
814CK	6" Arm

1 Kit Polybagged

Part #	Description
814PK	6" Arm



**Slant Sill Side Mount Torque Operator**  
1/2" ID Hole, w/ 3/16" Hub Projection.  
1 Per Card

Part #	Description
761C	RH Operator - Shown
762C	LH Operator - Opposite

1 Polybagged

Part #	Description
761P	RH Operator - Shown
762P	LH Operator - Opposite



**Philips Side Mount Operator**  
1/2" ID Hole, w/3/16" Hub Projection.  
1 Per Card

Part #	Description
735C	RH Operator - Shown
736C	LH Operator - Opposite

1 Polybagged

Part #	Description
735P	RH Operator - Shown
736P	LH Operator - Opposite



**Small Side Mount Operator**  
1/2" ID Hole, w/ 5/8" Hub Projection (pictured)  
1 Polybagged

Part #	Description
758PR	RH Operator - Shown
758PL	LH Operator - Opposite

1/2" ID Hole, w/ 1/8" Hub Projection

Part #	Description
804PR	RH Operator - Shown
804PL	LH Operator - Opposite



**Philips Side Mount Operator**  
1/2" ID Hole, w/11/16" Hub Projection.  
1 Per Card

Part #	Description
787CR	RH Operator - Shown
787CL	LH Operator - Opposite

1 Polybagged

Part #	Description
787PR	RH Operator - Shown
787PL	LH Operator - Opposite



**Side Mount Operator**  
1/2" ID Hole, w/1/4" Hub Projection.  
1 Per Card

Part #	Description
1712C	RH Operator - Shown
1713C	LH Operator - Opposite

1 Polybagged

Part #	Description
1712P	RH Operator - Shown
1713P	LH Operator - Opposite



**Side Mount Operator**  
1/2" ID Hole, w/1/2" Hub Projection.  
1 Per Card

Part #	Description
1716C	RH Operator - Shown
1717C	LH Operator - Opposite

1 Polybagged

Part #	Description
1716P	RH Operator - Shown
1717P	LH Operator - Opposite



**Side Mount Operator**  
1/2" ID Hole, w/11/16" Hub Projection.  
1 Per Card

Part #	Description
1718C	RH Operator - Shown
1719C	LH Operator - Opposite

1 Polybagged

Part #	Description
1718P	RH Operator - Shown
1719P	LH Operator - Opposite



**Side Mount Operator**  
1/2" ID Hole, w/1/2" Hub Projection.  
1 Per Card

Part #	Description
808CR	RH Operator - Shown
808CL	LH Operator - Opposite

1 Polybagged

Part #	Description
808PR	RH Operator - Shown
808PL	LH Operator - Opposite



**Side Mount Torque Bar Operator Kit**  
1/2" ID Hole, w/1/2" Hub Projection.  
1 Per Card

Part #	Description
808CKR	RH Operator - Shown
808CKL	LH Operator - Opposite

1 Polybagged

Part #	Description
808PKR	RH Operator - Shown
808PKL	LH Operator - Opposite



**Side Mount Operator**  
1/2" ID Hole, w/1/8" Hub Projection  
1 Per Card

Part #	Description
747CR	RH Operator - Shown
747CL	LH Operator - Opposite

1 Polybagged

Part #	Description
747PR	RH Operator - Shown
747PL	LH Operator - Opposite



**Side Mount Operator**  
3/8" Square w/1/8" Hub Projection  
1 Per Card

Part #	Description
749CR	RH Operator - Shown
749CL	LH Operator - Opposite

1 Polybagged

Part #	Description
749PR	RH Operator - Shown
749PL	LH Operator - Opposite

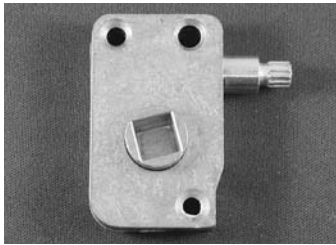

**RH Side Mount Operator**  
3/8" Square w/3/16" Hub Projection  
1 Per Card

Part #	Description
733C	Non-Handed

1 Polybagged

Part #	Description
733P	Non-Handed

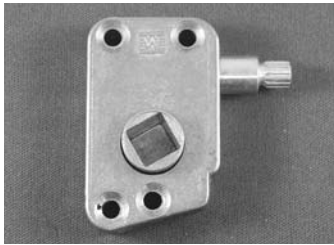

**Slant Sill Side Mount Operator**  
3/8" Square w/1/4" Hub Projection.  
1 Per Card

Part #	Description
715CR	RH Operator - Shown
715CL	LH Operator - Opposite

1 Polybagged

Part #	Description
715PR	RH Operator - Shown
715PL	LH Operator - Opposite



**Side Mount Operator**  
3/8" Square with No Hub Projection (Flush)  
1 Polybagged

Part #	Description
1709P	Non-Handed



**Side Mount Operator**  
1/2" ID Hole, w/1/8" Hub Projection.  
1 Per Card

Part #	Description
751CR	RH Operator - Shown

1 Polybagged

Part #	Description
751PR	RH Operator - Shown

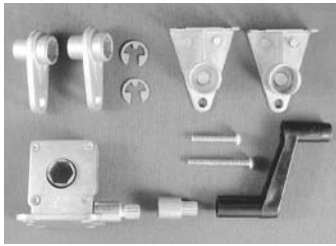

**Center Mount Operator Kit w/3/8" Hex**  
1 Kit Per Card

Part #	Description
802CK	1-1/4" x 1" Mounting Holes

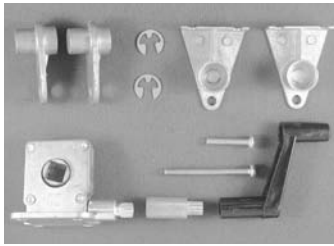

**Center Mount Operator Kit w/5/16" Square**  
1 Kit Per Card

Part #	Description
803CK	1-1/4" x 1" Mounting Holes

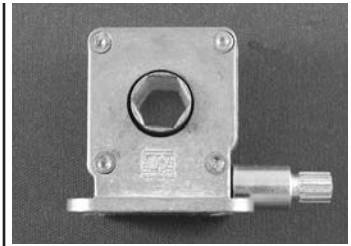

**Center Mount Operator with 3/8" Hex**  
1 Per Card

Part #	Description
802C	1-1/4" x 1" Mounting Holes

1 Polybagged

Part #	Description
802P	1-1/4" x 1" Mounting Holes



**Rack Operator with Links and E-Ring**  
1 Per Card

Part #	Description
800C	2-1/8" Mounting Holes

1 Kit Polybagged

Part #	Description
800P	2-1/8" Mounting Holes



**Rack Gear Replacement Operator Kit**  
1 Kit Per Card

Part #	Description
800CK	2-1/8" or 1-25/32" cc Mounting Holes

1 Kit Polybagged

Part #	Description
800PK	2-1/8" or 1-25/32" cc Mounting Holes



**Rack Gear Replacement Operator Kit**  
1 Kit Per Card

Part #	Description
816C	2-1/8" or 1-25/32" cc Mounting Holes

1 Kit Polybagged

Part #	Description
816P	2-1/8" or 1-25/32" cc Mounting Holes



**Rack Gear Replacement Operator Kit**  
1 Kit Per Card

Part #	Description
801CK	1-25/32" cc Mounting Holes

1 Kit Polybagged

Part #	Description
801PK	1-25/32" cc Mounting Holes

## E-RINGS AND GROOVE PINS

## TORQUE BAR BEARINGS



**E-Ring**  
8 Per Card

Part #	Description
325CE	Small 3/16"
328CE	Large 1/4"
324CE	X-Large 5/16"

8 Polybagged

Part #	Description
325PE	Small 3/16"
328PE	Large 1/4"
6-110	X-Large 5/16"



**Groove Pin w/Clip**  
1 Per Card

Part #	Description
328C	Large 1/4"

1 Polybagged

Part #	Description
20-409	Large 1/4"



**Nylon Torque Bar Bearing**  
1 Per Card

Part #	Description
763C	1/2" ID x 7/8" High

2 Per Card

Part #	Description
763C2	1/2" ID x 7/8" High

25 Polybagged

Part #	Description
763P	1/2" ID x 7/8" High



**Nylon Torque Bar Bearing**  
1 Per Card

Part #	Description
784C	1/2" ID x 1-1/16" High

2 Per Card

Part #	Description
784C2	1/2" ID x 1-1/16" High

25 Polybagged

Part #	Description
784P	1/2" ID x 1-1/16" High



**Nylon Torque Bar Bearing**  
1 Per Card

Part #	Description
1774C	1/2" ID x 3/4" High

2 Per Card

Part #	Description
1774C2	1/2" ID x 3/4" High

25 Polybagged

Part #	Description
1774P	1/2" ID x 3/4" High



**Nylon Torque Bar Bearing**  
1 Per Card

Part #	Description
1770C	1/2" ID x 3/4" High

2 Per Card

Part #	Description
1770C2	1/2" ID x 3/4" High

25 Polybagged

Part #	Description
1770P BLK	1/2" ID x 3/4" High

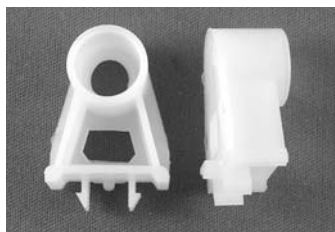

**Nylon Torque Bar Bearing**  
2 Per Card

Part #	Description
1703C	1/2" ID

25 Polybagged

Part #	Description
1703P	1/2" ID

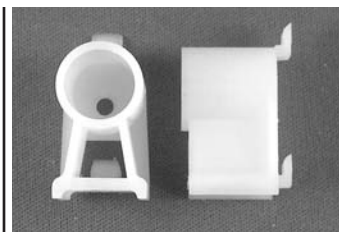

**Nylon Philips Torque Bar Bearing**  
2 Per Card

Part #	Description
738C	1/2" ID

25 Polybagged

Part #	Description
738P	1/2" ID

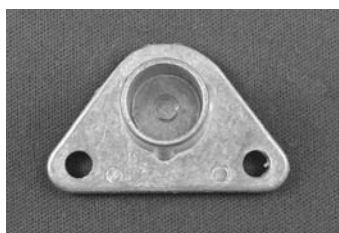

**Metal Torque Bar Bearing**  
1/2" ID  
1 Per Polybag

Part #	Description
719P	1-5/16" CC Mounting Holes



**Metal Torque Bar Bearing**  
1/2" ID  
1 Per Polybag

Part #	Description
760P	7/8" x 9/16" Bottom Measurements



**Metal Torque Bar Bearing**  
1/2" ID  
1 Per Polybag

Part #	Description
845P	7/8" cc Bottom Mounting Holes



**Metal Philips Torque Bar Arm**  
2 Per Card

Part #	Description
785C	1/2" ID / 1-11/16" Long

25 Polybagged

Part #	Description
785P	1/2" ID / 1-11/16" Long

# RV & MOBILE HOME HARDWARE

## TORQUE BAR ARMS



**Metal Torque Bar Arm**  
1 Per Polybag

Part #	Description
788P	For 1/2" OD Bar / 1-11/16" Long



**Metal Torque Bar Arm**  
1 Per Polybag

Part #	Description
724PS	3/8" Square / 1-9/16" Long

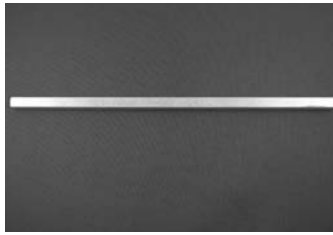

**Square Torque Bar**  
1 Per Card

Part #	Description
752PY	5/16" Dia. x 48" Long

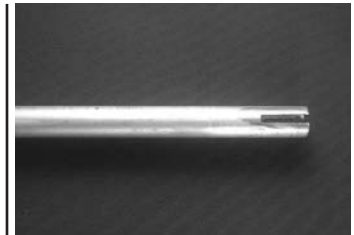

**Round Torque Bar**  
1 Per Polybag

Part #	Description
756PX	1/2" Dia. x 36" Long
756PY	1/2" Dia. x 48" Long

## VENT HINGES



**Hehr Small Metal Vent Hinge**  
1 Pair Per Card

Part #	Description
729C	Vent Hinge

1 Per Polybag

Part #	Description
729P	Vent Hinge



**Metal Vent Hinge w/Stud**  
1 Pair Per Card

Part #	Description
835C	4-3/8" Long

25 Polybagged

Part #	Description
835P	4-3/8" Long



**Metal Vent Hinge without Stud**  
1 Pair Per Card

Part #	Description
836C	4-3/8" Long

25 Polybagged

Part #	Description
836P	4-3/8" Long



**Metal Vent Hinge**  
1 Pair Per Card

Part #	Description
786C	3-7/8" Long

25 Polybagged

Part #	Description
786P	3-7/8" Long



**Metal Vent Hinge**  
1 Pair Per Card

Part #	Description
826C	4-5/16" Long

25 Polybagged

Part #	Description
826P	4-5/16" Long

## WINDOW LATCH



**Philips Nylon Window Latch Set**  
1 Set Per Card

Part #	Description
1723C	Black Latch Set - LH/RH

1 Set Per Polybag

Part #	Description
1723P	Black Latch Set - LH/RH



**Single Hung Sash Lock Assembly**  
1 Per Card

Part #	Description
1233C	Chrome Sash Lock - RH

5 Per Polybag

Part #	Description
50-624RHA	Chrome Sash Lock - RH

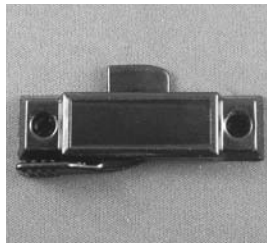

**Single Hung Black Sash Lock w/Screws**  
1 Per Card

Part #	Description
4290C BLK	2-1/4" cc Mounting Holes

1 Set Per Polybag

Part #	Description
50-603B	2-1/4" cc Mounting Holes



**Philips Storm Door Lever Latch**  
1 Per Card

Part #	Description
17-180RHBC	RH Black - Shown
17-180LHBC	LH Black - Opposite

1 Per Polybag

Part #	Description
17-180RHB	RH Black - Shown
17-180LHB	LH Black - Opposite

## LEVER LATCHES



**Screen Door Lever Handle**  
1 Per Card

Part #	Description
17-192RHBC	RH Black - Shown

1 Per Polybag

Part #	Description
17-192RHB	RH Black - Shown



## LEVER LATCHES



Amerimax Storm Door Lever Latch  
1 Per Card

Part #	Description
17-166RHBC	RH Black - Shown
17-166LHBC	LH Black - Opposite

1 Per Polybag

Part #	Description
17-166RHB	RH Black - Shown
17-166LHB	LH Black - Opposite

## JALOUSIE OPERATOR & HANDLE



Universal Kit - Aluminum Finish  
1 Per Card

Part #	Description
4000CK	Jalousie Operator

1 Per Polybag

Part #	Description
41J-4000PK	Jalousie Operator



Jalousie Tee Handle  
1 Per Card

Part #	Description
306CAJ	5/16" Aluminum

1 Per Polybag

Part #	Description
37-106	5/16" Aluminum

## TRAILER LATCH



1 Per Card

Part #	Description
4244CA	Low Profile Trailer Lock w/Key

1 Per Polybag

Part #	Description
17-21KA	Low Profile Trailer Lock w/Key

Aluminum

## INSECT SCREENING



Charcoal Fiberglass  
1 Roll

Part #	Description
69-61-7	36" Wide x 7' Long

## SCREEN SPLINE



Hollow Round Gray Screen Spline  
1 Per Card

Part #	Description
309C	.140 (9/64") dia. x 20 ft.
310C	.156 (5/32") dia. x 20 ft.



Hollow Round Black Screen Spline  
1 Per Card

Part #	Description
309C BLK	.140 (9/64") dia. x 20 ft.
310C BLK	.156 (5/32") dia. x 20 ft.

## INSTALLATION TOOL



Screen Installation Tool  
1 Per Card

Part #	Description
1201C	1/16" Nylon Wheels
1202C	5/32" Nylon Wheels

Bulk

Part #	Description
59-10SP	1/16" Nylon Wheels
59-10	5/32" Nylon Wheels

## CLIPS



Zee Clip w/Screws  
6 Per Card

Part #	Description
350C	Metal / 1/8" Offset



Nylon Screen Clip w/Screws  
6 Per Card

Part #	Description
492C	Flush
494C	1/16" Offset
495C	3/16" Offset
496C	1/4" Offset
497C	5/16" Offset
498C	3/8" Offset
499C	7/16" Offset



Nylon Screen Clip, No Screws  
25 Polybagged

Part #	Description
90-834	Flush
90-78	1/16" Offset
90-381	3/16" Offset
90-837	1/4" Offset
90-332	5/16" Offset
90-379	3/8" Offset
90-380	7/16" Offset



Nylon Screen Clip w/Screws  
6 Per Card

Part #	Description
490C	Flat, No Offset

Nylon Screen Clip No Screws  
25 Polybagged

Part #	Description
90-77	Flat, No Offset

# RV & MOBILE HOME HARDWARE

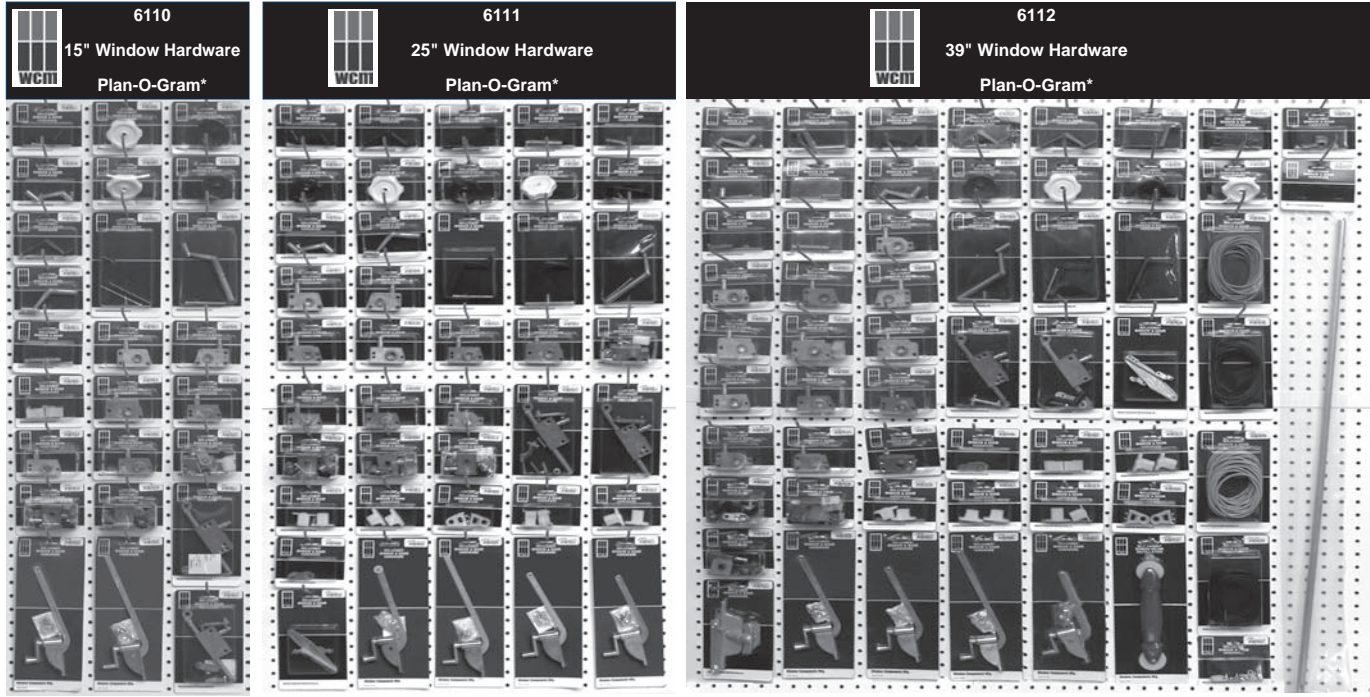

All plan-o-grams include a 16" x 9" header sign, standard peg hooks, and reorder cards for each SKU.

Part #	Description	Peg Qty.	6110	6111	6112
1202C	5/32" Screen Installation Tool w/ Nylon Wheels	3			
1233C	Single Hung Chrome Sash Lock	3			
1703C	Nylon 1/2" Torque Bar Bearing	3		*	*
1712C	RH Side Mount Operator 1/2" Hole, w/ 1/4" Hub Projection	3		*	*
1716C	RH Side Mount Operator 1/2" Hole, w/ 1/2" Hub Projection	3	*	*	*
1718C	RH Side Mount Operator 1/2" Hole, w/ 11/16" Hub Projection	3	*	*	*
1770C2	Nylon Torque Bar Bearing 3/4" High	3		*	*
1774C2	Nylon Torque Bar Bearing 3/4" High	3		*	*
309C	140 Hollow Round Gray Screen Spline	3		*	*
309C BLK	140 Hollow Round Black Screen Spline	3		*	*
310C	156 Hollow Round Gray Screen Spline	3		*	*
310C BLK	156 Hollow Round Black Screen Spline	3		*	*
4000CK	Universal Jalousie Operator Kit	3		*	*
4290C BLK	Miller Single Hung Black Sash Lock	3		*	*
492C	Flush Clear Plastic Screen Clip w/ Screw	3		*	*
712C BLK	3-3/16" Black Plastic Crank Handle w/ Screw	3	*	*	*
715CR	RH Slant Sill Side Mount Operator 3/8" Square w/ 1/4" Hub Projection	3		*	*
733C	RH Side Mount 3/8" Square, w/ 3/16" Hub Projection	3		*	*
735C	RH Side Mount Phillips Operator 1/2" Hole, w/ 3/16" Hub Projection	3	*	*	*
738C	Nylon Phillips Torque Bar Bearing	3	*	*	*
743C BLK	Black Plastic Knob Handle w/ Screw	3	*	*	*
743C WHT	White Plastic Knob Handle w/ Screw	3	*	*	*
743CE BLK	Black Plastic Knob Handle w/ Screw	3	*	*	*
743CE WHT	White Plastic Knob Handle w/ Screw	3	*	*	*
747CR	RH Side Mount Operator 1/2" Hole, w/ 1/8" Hub Projection	3		*	*
748C BLK	1-3/8" Black Plastic Crank Handle w/ Screw	3		*	*
749CR	RH Side Mount Operator 3/8" Square w/ 1/18" Hub Projection	3		*	*
750C BLK	2-1/4" Black Plastic Crank Handle w/ Screw	3		*	*
756PX	1/2" Diameter x 36" Round Torque Bar	3		*	*
761C	RH Slant Sill Side Mount Torque Operator 1/2" Hole, w/ 3/16" Hub Projection	3	*	*	*
762C	LH Slant Sill Side Mount Torque Operator 1/2" Hole, w/ 3/16" Hub Projection	3	*	*	*
763C2	Nylon 7/8" High Torque Bar Bearing	3		*	*
771C BLK	2-1/2" Black Plastic Crank Handle w/ Screw	3		*	*
781C	RH Side Mount Operator 1/2" Hole, w/ 1/2" Hub Projection	3		*	*
783C	Roof Vent Metal Crank Handle w/ Screw	3		*	*
784C2	Nylon 1-1/16" High Torque Bar Bearing	3		*	*
785C	Metal Phillips Torque Bar Arm	3		*	*
787CR	RH Side Mount Phillips Operator 1/2" Hole, w/ 11/16" Hub Projection	3	*	*	*
795C	1-3/4" Metal Crank Handle w/ Screw	3		*	*
796C	3-1/2" Metal Crank Handle w/ Screw	3		*	*
800CK	Rack Gear Replacement Operator Kit 2-1/8" cc Mounting	3		*	*
801ck	Rack Gear Replacement Operator Kit 1-25/32" cc Mounting	3		*	*
802ck	Center Mount Operator Kit 3/8" Hex, w/ 1" cc Mounting Holes	3		*	*
803ck	Center Mount Operator Kit 5/16" Square, w/ 1" cc Mounting Holes	3		*	*
806ck	Arm Gear Roof Vent Operator Kit, w/ 5-3/8" Arm 2-15/16" cc Mounting	3		*	*
807ck	Arm Gear Roof Vent Operator Kit, w/ 7-11/16" Arm 2-15/16" cc Mounting	3		*	*
808ck	RH Side Mount Torque Bar Operator Kit, w/ 1/2" Hole, 1/2" Hub Projection	3		*	*
812CK	Center Mount Operator Kit 3/8" Hex, w/ 1" cc Mounting Holes	3		*	*
814CK	Arm Gear Roof Vent Operator Kit, w/ 7-11/16" Arm 2-15/16" cc Mounting	3		*	*
831C	1/2" Metal Extension w/ Screw	3		*	*
832C	7/8" Metal Extension w/ Screw	3		*	*
833C	1-1/8" Metal Extension w/ Screw	3		*	*
834C	2" Metal Extension w/ Screw	3		*	*
835C	Vent Hinge w/ Stud	3		*	*
838C BLK	1" Black Plastic Crank Handle w/ Screw	3	*	*	*
881C BLK	1-3/4" Black Plastic Crank Handle w/ Screw	3	*	*	*
889C	1" Metal Crank Handle w/ Screw	3	*	*	*
898ck	Arm Gear Roof Vent Operator Kit w/ 5-3/8" Arm, 2-15/16" cc Mounting	3	*	*	*
6110	15" Window Hardware Plan-o-gram				
6111	25" Window Hardware Plan-o-gram				
6112	39" Window Hardware Plan-o-gram				

# WINDOW/DOOR GLAZING & WEATHERSTRIPPING

## SNAP-IN-VINYL GLAZING BEAD

Glazing bead is grouped by shape. Sold per foot - Available in 6ft. lengths unless otherwise specified, minimum 120'

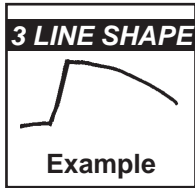

Please Consult Your Representative for Additional Colors, Styles and Sizes

Actual Size

Part #	Color
65-30	White
65-29	Lt. Gray

Actual Size

Part #	Color
65-26	Dk. Gray
65-25	White

Actual Size

Part #	Color
65-8	Brown
65-8W	White

Actual Size

Part #	Color
65-1	Lt. Gray
65-59	Black

**PORTALUME**

Actual Size

Part #	Color
65-69	Brown
65-69W	White

**CAPITOL - 800 SERIES**

Actual Size

Part #	Color
65-60	White
65-60B	Black

**DECO**

Actual Size

Part #	Color
65-61	White
65-61B	Black

**SILVERLINE**

Actual Size

Part #	Color
65-66	Gray
65-67	White

Muntin Bar Bead Refer to pg. 256.  
Used on 65-36 Bead Only - All 6" Lengths

Actual Size

Part #	Color
65-78B	Black
65-78W	White

Actual Size

Part #	Color
900-16303	Gray
900-16303W	White

Actual Size

Part #	Color
900-11480	Brown
900-11480W	White

**CAPITOL**

Actual Size

Part #	Color
900-11481	Brown
900-11481W	White

**CAPITOL**

Actual Size

Part #	Color
900-14895	Black
900-14895W	White

**KRESTMARK**

Actual Size

Part #	Color
900-16724	White
900-16724DB	Bronze

# WINDOW/DOOR GLAZING & WEATHERSTRIPPING

## SNAP-IN-VINYL GLAZING BEAD

Glazing bead is grouped by shape. Sold per foot - Available in 6ft. lengths unless otherwise specified, minimum 120'

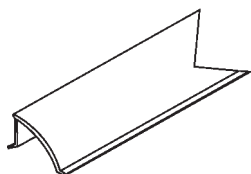

Actual Size

Part #	Color
900-16422	White
900-16422BK	Black
900-16422DB	Dark Bronze
900-16422G	Gray

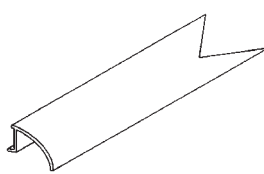

Actual Size

Part #	Color
900-16344	Gray
900-16344B	Black
900-16344DB	Dark Bronze
900-16344W	White

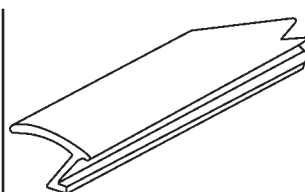

Actual Size

Part #	Color
65-4	White
65-5	Lt. Gray

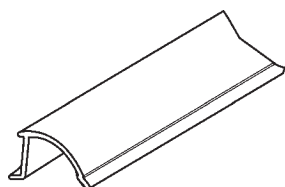

Actual Size

Part #	Color
65-352	White

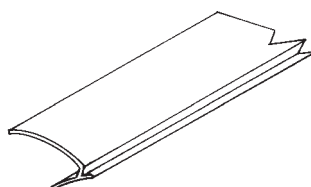

Actual Size

Part #	Color
900-17190	White

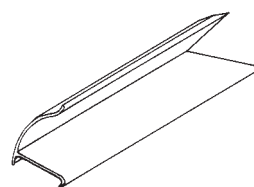

Actual Size

Part #	Color
900-18492	White

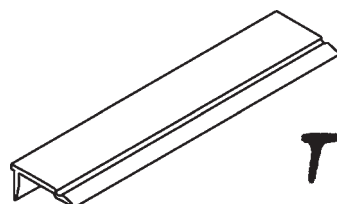

Actual Size

Part #	Color
900-17870	White
900-17870BZ	Bronze

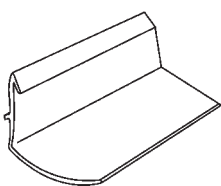

Actual Size

Part #	Color
900-11015DB	Bronze
900-11015W	White

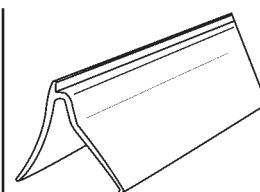

Actual Size

Part #	Color
65-350W	White
65-350BZ	Bronze

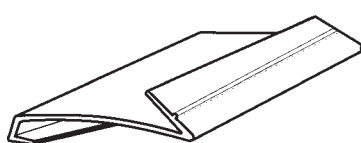
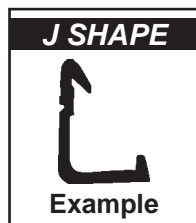

Actual Size

Part #	Color
65-321B	Black
65-321W	White

**ALENCO**

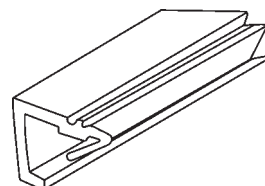

Actual Size

Part #	Color
65-42	Black
65-42W	White

**REYNOLDS**

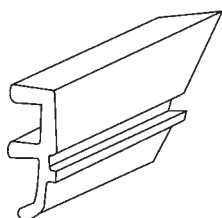

Actual Size

Part #	Color
65-44	Lt. Gray

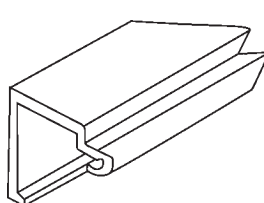

Actual Size

Part #	Color
65-20	White

**KELLER**

Note: Large minimum required

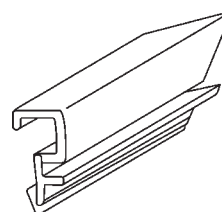

Actual Size

Part #	Color
65-45	White
65-46	Brown

# WINDOW/DOOR GLAZING & WEATHERSTRIPPING

## SNAP-IN-VINYL GLAZING BEAD

Glazing bead is grouped by shape. Sold per foot - Available in 6ft. lengths unless otherwise specified, minimum 120'

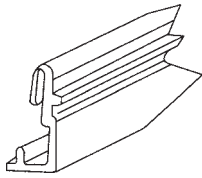

Actual Size

Part #	Color
65-48	Brown
65-48LBR	Light Brown
65-49	White

**PENNCO**

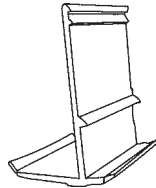

Actual Size

Part #	Color
65-367	Gray

Dual Durometer. Sold in 8' Length with 15 Length Minimum

**CRESTLINE/PEACHTREE**

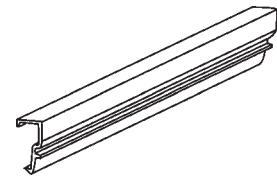

Actual Size

Part #	Color
65-57	Brown
65-58	White

**CAPITOL**

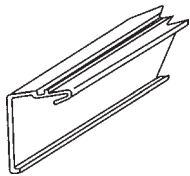

Actual Size

Part #	Color
65-47	Brown
65-47W	White

**PENNCO**

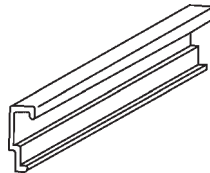

Actual Size

Part #	Color
65-50	White

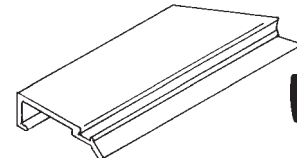

Actual Size

Part #	Color
65-52	White
65-52B	Black

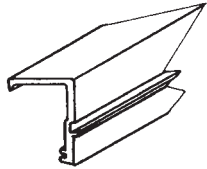

Actual Size

Part #	Color
900-9093	White

**CAPITOL**

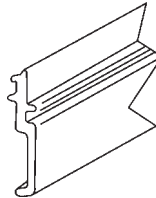

Actual Size

Part #	Color
900-8745	Black

**ACORN**

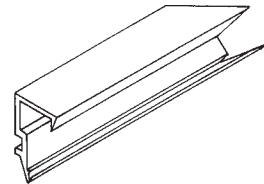

Actual Size

Part #	Color
900-16144	Dark Bronze

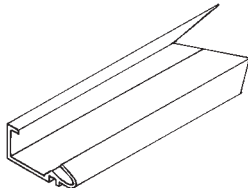

Actual Size

Part #	Color
900-17559	Black

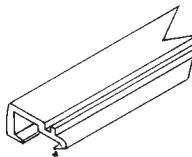

Clear flexible seal integrated here



Actual Size

Part #	Color
900-12029W	White
900-12029	Bronze

Dual Durometer  
**PENNCO**

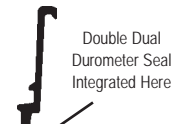
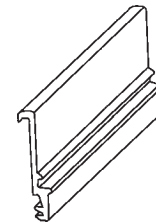

Actual Size

Double Dual Durometer Seal Integrated Here

Part #	Color
65-101NS	Black

**ACORN 2300 SERIES**

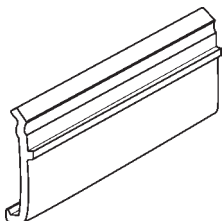

Actual Size

Part #	Color
65-104	Black
65-104W	White

**ACORN 2300 SERIES**

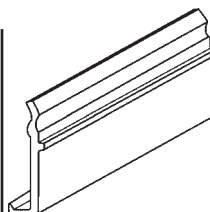

Actual Size

Part #	Color
65-106	Black
65-106W	White

**ACORN 2900 SERIES**

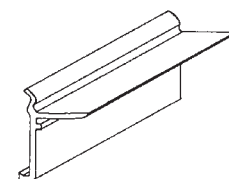

Actual Size

Part #	Color
65-105	Black
65-105W	White

**ACORN 2300/3300 SERIES**

# WINDOW/DOOR GLAZING & WEATHERSTRIPPING

## SNAP-IN-VINYL GLAZING BEAD

Glazing bead is grouped by shape. Sold per foot - Available in 6ft. lengths unless otherwise specified, minimum 120'

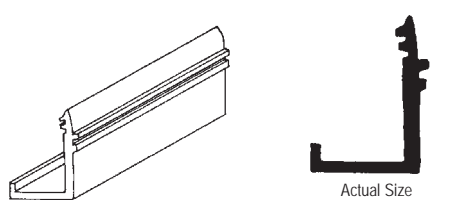

Actual Size

Part #	Color
65-108	Black

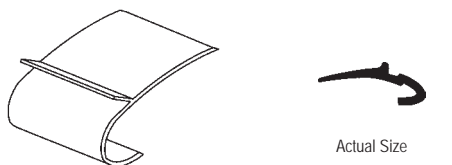

Actual Size

Part #	Color
65-88	Gray
65-88BZ	Bronze

Part #	Color	Length
65-168	Bronze	50-1/2"

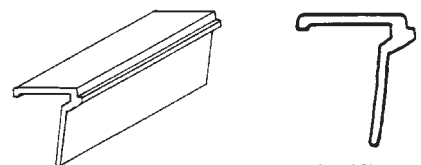

Actual Size

Part #	Color
65-89B	Black
65-89BZ	Bronze
65-89W	White

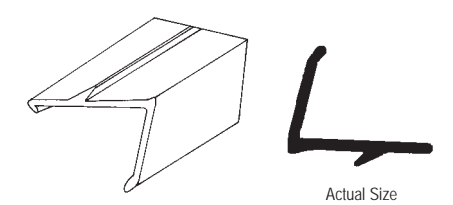

Actual Size

Part #	Color
65-90	White

Dual Durometer. Old Wenco Bead Cut 6' Lengths  
**WENCO**

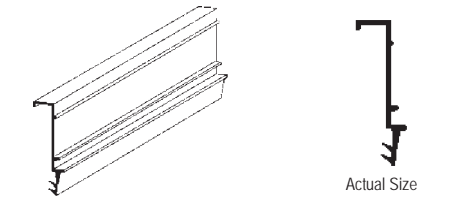

Actual Size

Part #	Color
900-11865	Black
900-11865W	White

**ACORN**

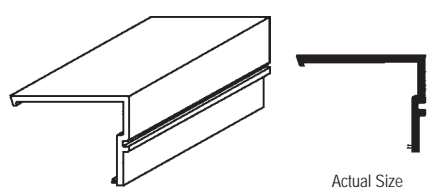

Actual Size

Part #	Color
900-11563	Brown
900-11563W	White

Dual Durometer

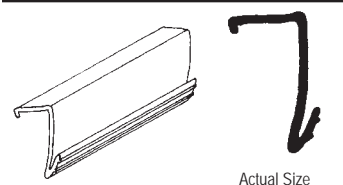

Actual Size

Part #	Color
900-16067	White
900-16067A	Almond
900-16067B	Black

**ACORN**



Actual Size

Part #	Color
900-17496	White
900-17496BZ	Bronze

Dual Durometer

**PENNCO**

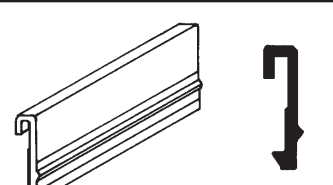

Actual Size

Part #	Color
900-17499	White
900-17499BR	Brown

**PENNCO**

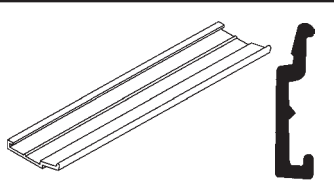

Actual Size

Part #	Color
900-17510	White

Head Vinyl Glazing Stop

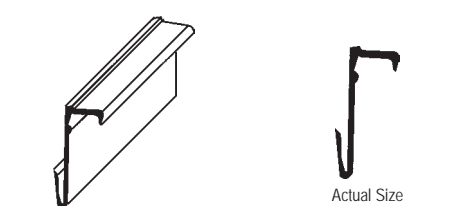

Actual Size

Part #	Color
900-18453BL	Black
900-18453W	White

**Winterseal**

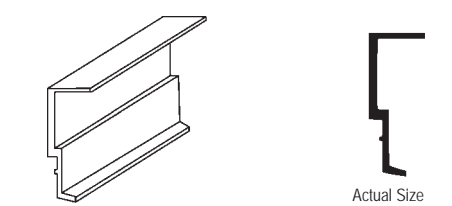

Actual Size

Part #	Color
900-18550	White

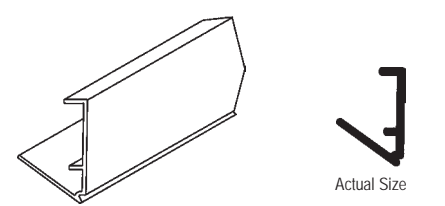

Actual Size

Part #	Color
65-531W	White

For Insulated Glass  
**MILESTONE/FLORIDA EXTRUDERS**

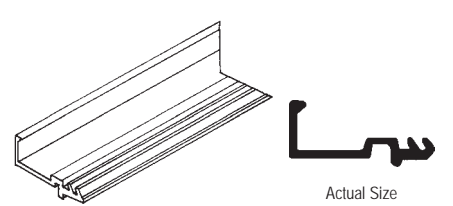

Actual Size

Part #	Color
900-8744	Black

Dual Durometer

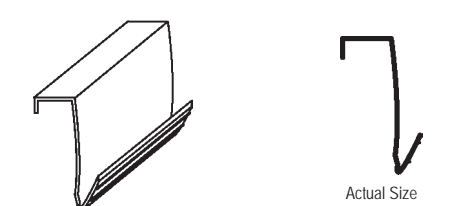

Actual Size

Part #	Color
65-135	White
65-135A	Almond

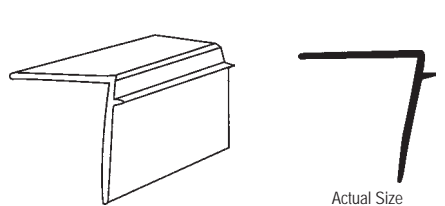

Actual Size

Part #	Color
65-240W	White

# WINDOW/DOOR GLAZING & WEATHERSTRIPPING

## SNAP-IN-VINYL GLAZING BEAD

Glazing bead is grouped by shape. Sold per foot - Available in 6ft. lengths unless otherwise specified, minimum 120'

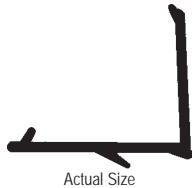
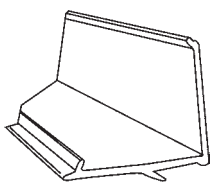

Actual Size

Part #	Color
65-365W	White

### Barber & Ross

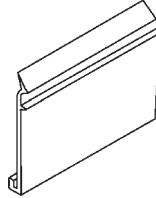

Actual Size

Part #	Color
65-132	Black
65-132W	White

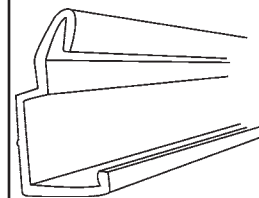

Actual Size

Part #	Color
900-15383	Dark Gray

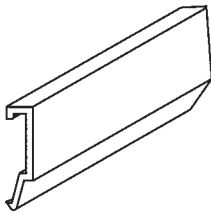

Actual Size

Part #	Color
65-545W	White

Sold in 8' Lengths w/ 15 Length Minimum

### VEKA

### 5 LINE SHAPE



### Example

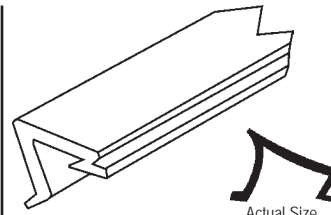

Actual Size

Part #	Color
65-41	White
65-40	Lt. Gray



Actual Size

Part #	Color
65-32BR	Bronze
65-32	Brown
65-33	White
65-43	Black

### CROSSLY

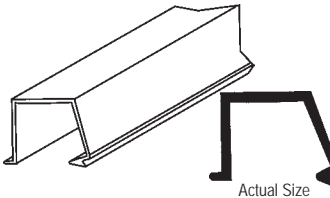

Actual Size

Part #	Color
65-533W	White

For Single Pane Glass

### MILESTONE/FLORIDA EXTRUDERS

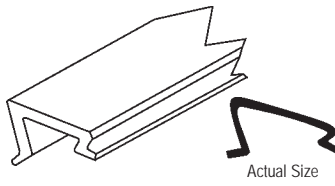

Actual Size

Part #	Color
65-28	White
65-27	Black

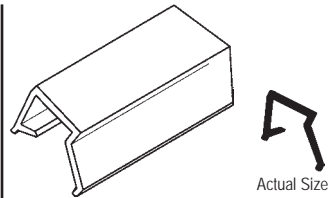

Actual Size

Part #	Color
65-281W	White
65-281TN	Tan

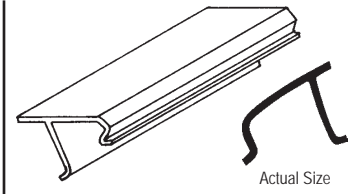

Actual Size

Part #	Color
900-12920	White
900-12920BZ	Bronze

### ROLLYSON 2000 SERIES

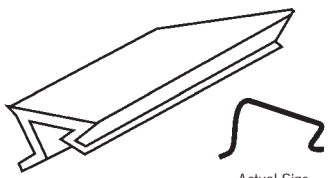

Actual Size

Part #	Color
65-16	Black
65-15	Brown

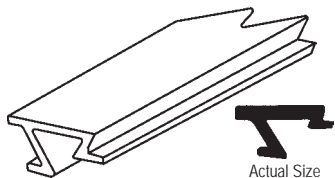

Actual Size

Part #	Color
65-17	Lt. Gray
65-12	Black
65-3	White

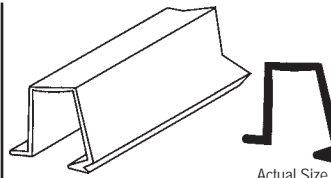

Actual Size

Part #	Color
65-532W	White

For Impact Glass

### MILESTONE/FLORIDA EXTRUDERS



Actual Size

Part #	Color
65-71	Black
65-71W	White

(Twenty 6 ft. Lengths of the Same Bead or a Combination of Different Beads)

### BINNINGS

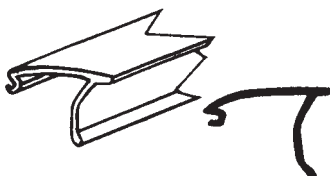

Actual Size

Part #	Color
900-8668	White
900-8668B	Black

### BINNINGS

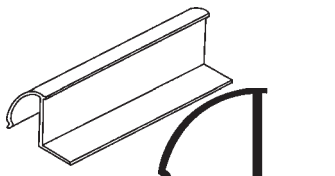

Actual Size

Part #	Color
900-16683	White
900-16683BZ	Bronze

### BELLVIEW

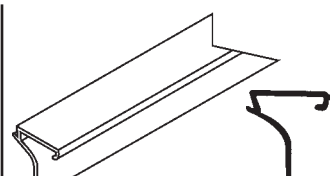

Actual Size

Part #	Color
900-17038	Black
900-17038W	White



Actual Size

Part #	Color
65-87	Gray
65-87B	Black

# WINDOW/DOOR GLAZING & WEATHERSTRIPPING

## SNAP-IN-VINYL GLAZING BEAD

Glazing bead is grouped by shape. Sold per foot - Available in 6ft. lengths unless otherwise specified, minimum 120'

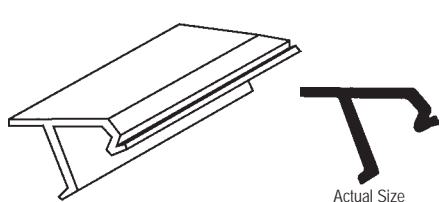

Part #	Color
900-10613	Bronze
900-10613W	White

**ROLLYSON**

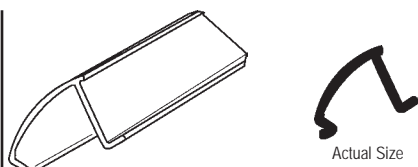

Part #	Color
65-85	White
65-85BZ	Bronze

CE  
6' Length

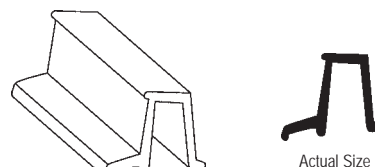

Part #	Color
900-14969BL	Black
900-14969	White
900-14969BZ	Bronze

**PHILIPS/AIR CONTROL**

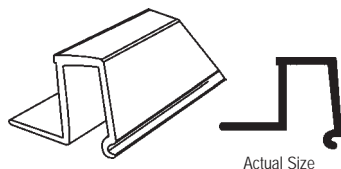

Part #	Color
900-19000	Black
900-19000BR	Brown
900-19000BZ	Bronze
900-19000W	White

**MILESTONE 2000 SERIES  
FLORIDA EXTRUDERS**

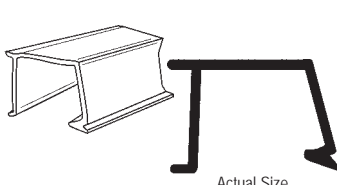

Part #	Color
65-467W	White

**MILESTONE/FLORIDA  
EXTRUDERS**

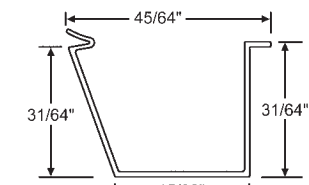

Part #	Color
65-488W	White

**MILESTONE/FLORIDA  
EXTRUDERS**

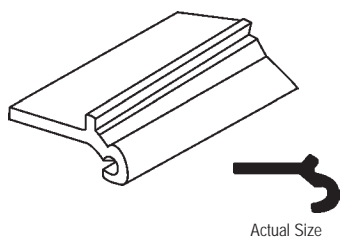
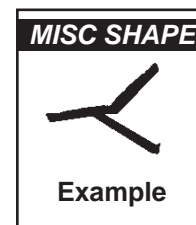

Part #	Color
65-39	Lt. Gray

**CAPITOL**

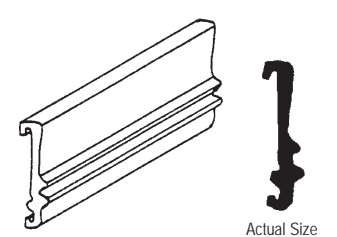

Part #	Color
65-101	Black

**ACORN 2300 SERIES**

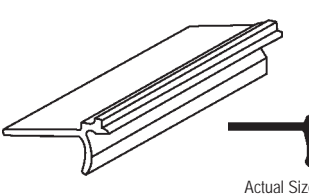

Part #	Color
65-91	White
65-91B	Black

**ROLLYSON 1500 SERIES**

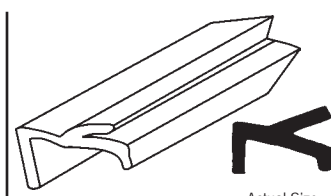

Part #	Color
65-6	White
65-7	Black

**V.E. ANDERSON**

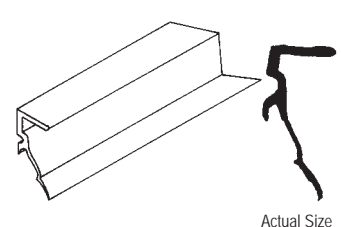

Part #	Color
900-14844	White

**WINTERSEAL**

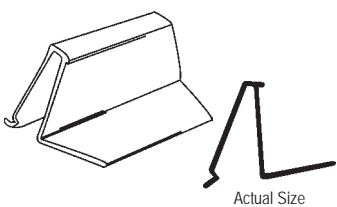

Part #	Color
900-9954	Black
900-9954W	White

**KELLER**

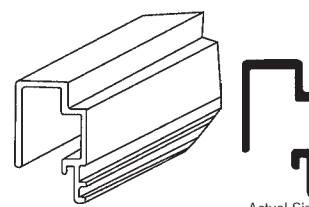

Part #	Color
900-11386	Black

**ACORN 2300 SERIES**

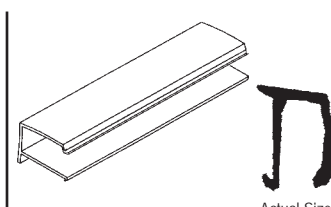

Part #	Color
900-18970BL	Black
900-18970W	White

**ROLLYSON 2500 SERIES**

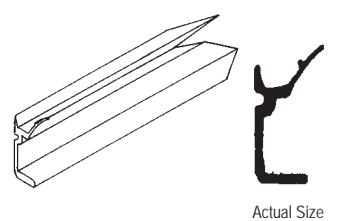

Part #	Color
900-15075	White

**WINTERSEAL**

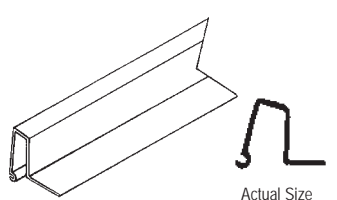

Part #	Color
900-16343	Bronze
900-16343W	White

**ROLLYSON 2500 SERIES**

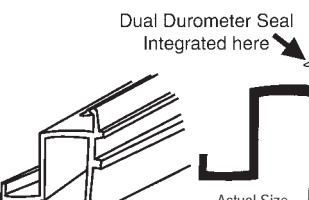

Part #	Color
900-20713W	White

Dual Durometer

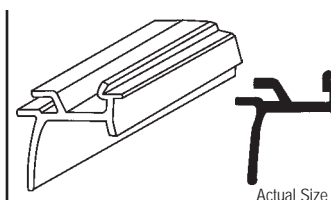

Part #	Color
900-20292	White
900-20292BR	Brown

**ROLLYSON 2500 SERIES**



# WINDOW/DOOR GLAZING & WEATHERSTRIPPING

## SNAP-IN-VINYL GLAZING BEAD

Glazing bead is grouped by shape. Sold per foot - Available in 6ft. lengths unless otherwise specified, minimum 120'

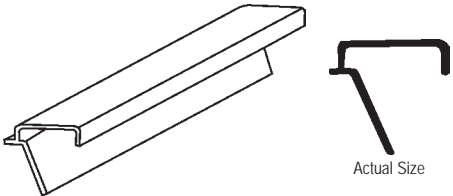

Actual Size

Part #	Color
65-64	Brown

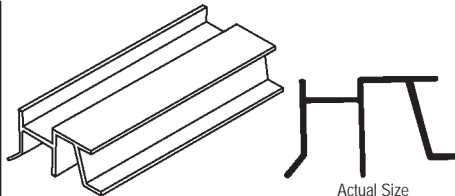

Actual Size

Part #	Color
65-53	White

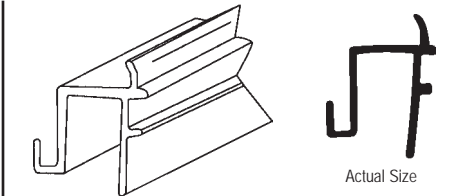

Actual Size

Part #	Color
65-70	White
65-70DB	Dark Bronze

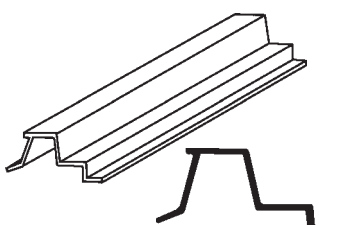

Actual Size

Part #	Color
65-55	White

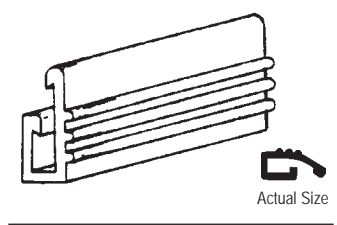

Actual Size

Part #	Color
65-31W	White
65-31	Dark Gray

**CAPITOL**

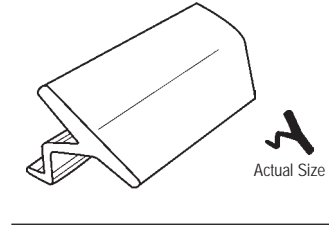

Actual Size

Part #	Color
900-21518	Black
900-21518G	Gray

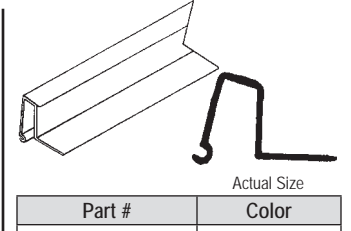

Actual Size

Part #	Color
900-16225	White
900-16225BZ	Bronze

Keller, Single Hung 76,  
General Aluminum & Krestmark

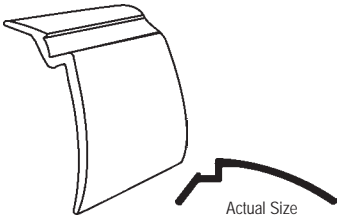

Actual Size

Part #	Color
65-213W	White

**PHILIPS**

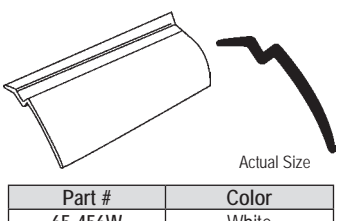

Actual Size

Part #	Color
65-456W	White
65-456TN	Tan
65-456BZ	Bronze

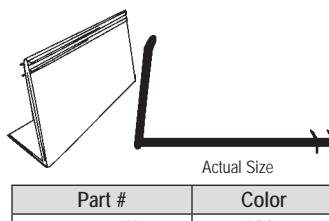

Actual Size

Part #	Color
65-183W	White

**HURD/RIVCO**

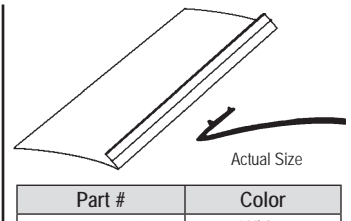

Actual Size

Part #	Color
900-16212	White
900-16212B	Black

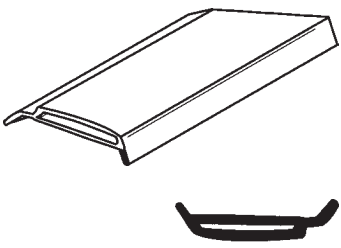

Actual Size

Part #	Color
65-514W	White

**PGT**

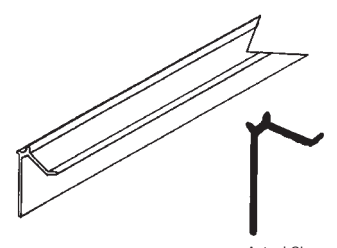

Actual Size

Part #	Color
900-18869	White

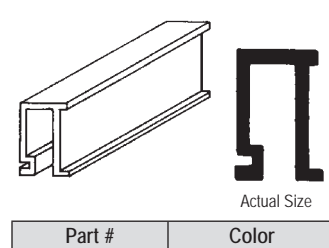

Actual Size

Part #	Color
900-9953NEW	Black
900-9953NW	White

New style  
**KELLER**

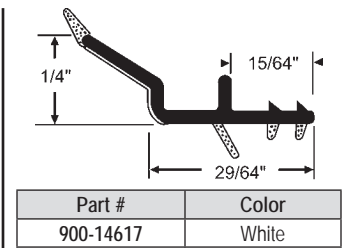

Actual Size

Part #	Color
900-14617	White
900-14617BG	Beige
900-14617BZ	Bronze

1/4" 15/64" 29/64"

All 8' Lengths.  
**NORCO/VETTER/JELD-WEN**

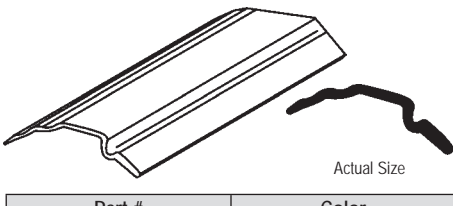

Actual Size

Part #	Color
65-515W	White

**PGT**

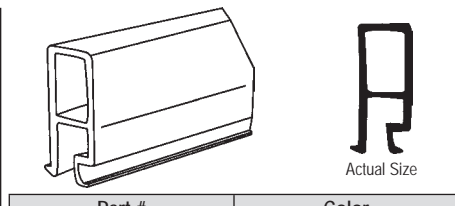

Actual Size

Part #	Color
65-235W	White

**ACORN**

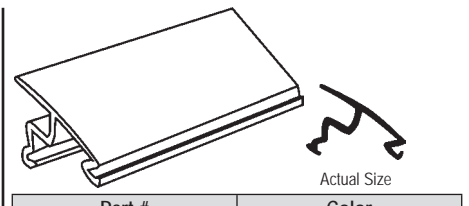

Actual Size

Part #	Color
65-241W	White

**KINRO/ACORN**

# WINDOW/DOOR GLAZING & WEATHERSTRIPPING

## SNAP-IN-VINYL GLAZING BEAD

Glazing bead is grouped by shape. Sold per foot - Available in 6ft. lengths unless otherwise specified, minimum 120'

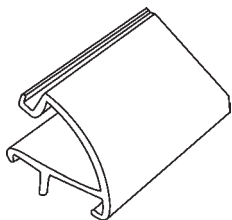

Actual Size

Part #	Color
65-95	White

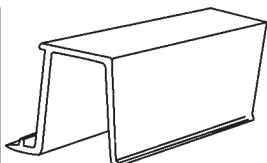

Actual Size

Part #	Color
900-18974BL	Black
900-18974BZ	Bronze
900-18974W	White

**PHILIPS**

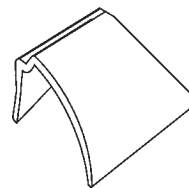

Actual Size

Part #	Color
65-318W	White

**KINRO/ACORN**

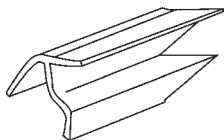

Actual Size

Part #	Color
65-73	White
65-73B	Black
65-73BZ	Bronze
65-73G	Gray

**CROFT**

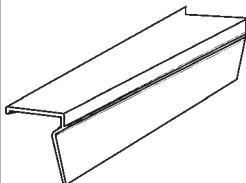

Actual Size

Part #	Color
900-19291DB	Dark Bronze
900-19291WH	White

## TRACKS

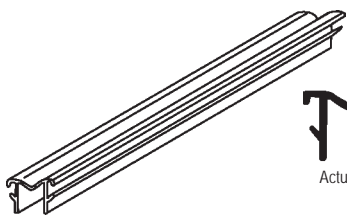

Actual Size

Part #	Color
65-65	Black

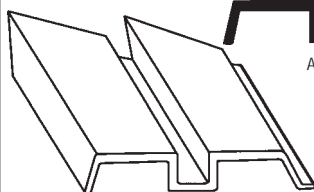

Actual Size

Part #	Color
65-68	Charcoal

**CAPITOL**

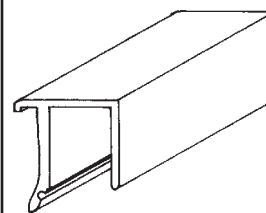

Actual Size

Part #	Color
65-81W	White

**SEASONALL**

## MUNTIN BARS

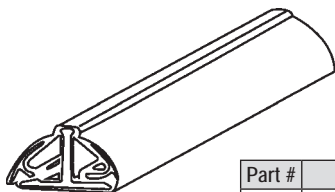

Actual Size

Part #	Color
65-36	White with White bead

Note: All 6' Lengths

**CAPITOL**

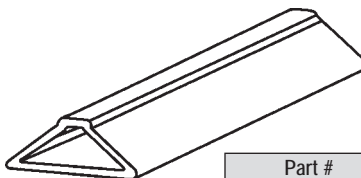

Actual Size

Part #	Color
65-37	White

Aluminum. All 8' Lengths

## PLUNGER



**90-1024**

Nylon

## MUNTIN CLIPS

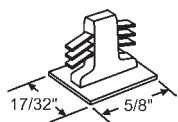

**90-1022B**

Black

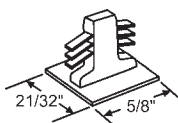

**90-1023B**

Black

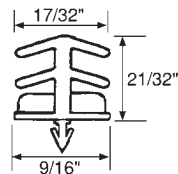

**90-630**

White Nylon

## GRILLE PINS

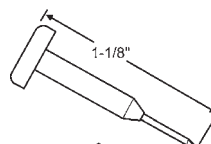

**90-857**

Clear Plastic w/ Steel Shaft

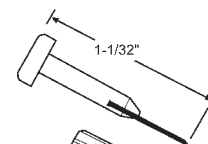

**90-973**

Clear Plastic w/ Steel Shaft

# WINDOW/DOOR GLAZING & WEATHERSTRIPPING

## WINDOW GRILLE KIT

The window grille kit is simple to install and easy to remove for cleaning at a fraction of the typical cost. The kit contains enough material for a standard size window or door including: 12 pieces of 24" Profile, 8 "X" Connectors and 16 Fasteners.

The Window Grille Kit can be used on wood, vinyl or aluminum materials. These attractive profiles are currently available in white only.

90-516

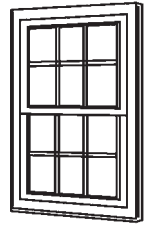
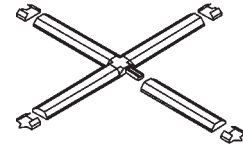
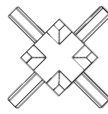
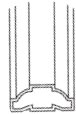

profile + connectors + fasteners + together =

## METAL GLAZING BEAD

Sold by Length - 72" = 1 Length. Minimum 10 Lengths.

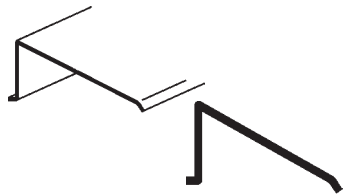

Actual Size

Part #	Color
65-516W	White

**PGT**

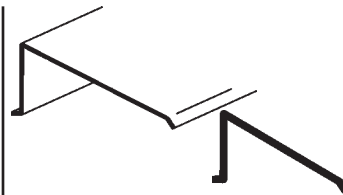

Actual Size

Part #	Color
65-517W	White

**PGT**

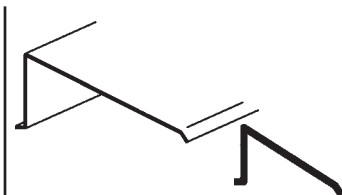

Actual Size

Part #	Color
65-518W	White

**PGT**



Actual Size

Part #	Color
65-158-6	Aluminum
65-159-6	Bronze
65-160	White

Single Hung  
**YALE**

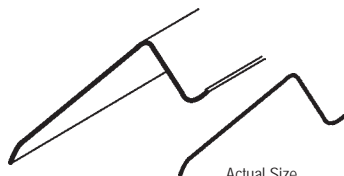

Actual Size

Part #	Color
65-161-6	Aluminum
65-161W-6	White

Awning Type Window  
**YALE**

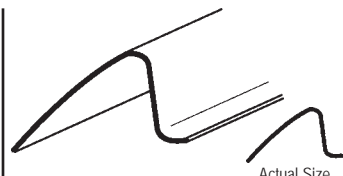

Actual Size

Part #	Color
65-154-6	Aluminum
65-155-6	White

Single Hung  
**HARCAR**



Actual Size

Part #	Color
65-163-6	Aluminum

Single Hung  
**ABC/CROWN/TUCKER**

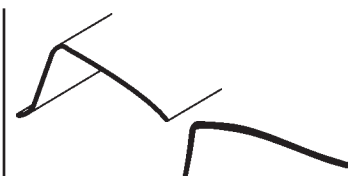

Actual Size

Part #	Color
65-164	Aluminum

Single Hung  
**KINCO**

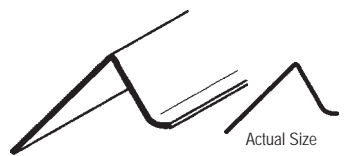

Actual Size

Part #	Color
65-143	Aluminum
65-144	White
65-145	Bronze

Single Hung  
**PAN AM**

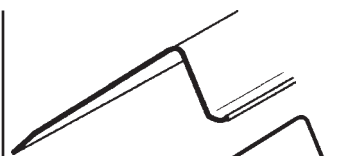

Actual Size

Part #	Color
65-146	Aluminum

Awning Type Window  
**PAN AM**

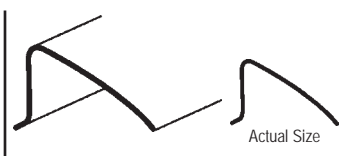

Actual Size

Part #	Color
65-156-6	Aluminum
65-157-6	White
65-156BZ-6	Bronze

Awning Type Window  
**HARCAR**



Actual Size

Part #	Color
65-166-6	Aluminum
65-167	Bronze

Single Hung  
**SECURITY**

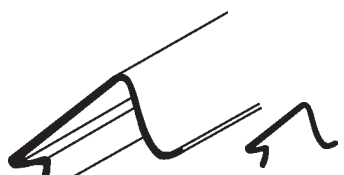

Actual Size

Part #	Color
65-117	Mill

6' Length



Actual Size

Part #	Color
65-460	Mill
65-461	Bronze
65-462	White

**PAN AM**

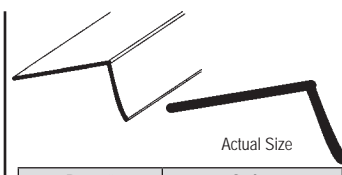

Actual Size

Part #	Color
65-479	Mill
65-479BZ	Bronze
65-479W	White

**CROWN**

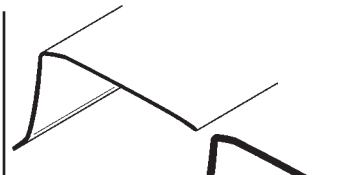

Actual Size

Part #	Color
65-482	Mill
65-482BZ	Bronze

**SECURITY**

# WINDOW/DOOR GLAZING & WEATHERSTRIPPING

## METAL GLAZING BEAD

Sold by Length - 72" = 1 Length. Minimum 10 Lengths.

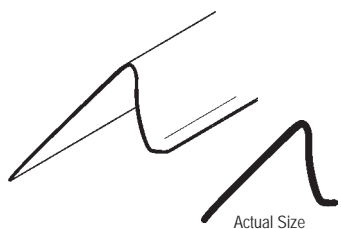

Part #	Color
65-483	Mill
65-483W	White

**JACOBSON**

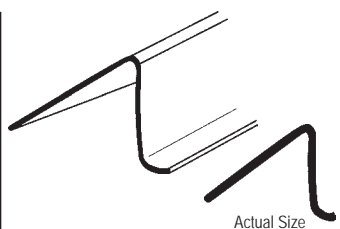

Part #	Color
65-480	Mill
65-480BZ	Bronze

**HARCAR**

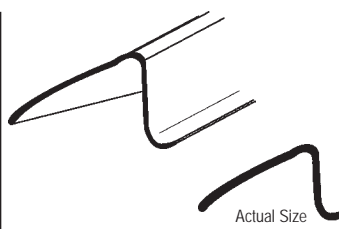

Part #	Color
65-113	Mill
65-113BZ	Bronze

**VINYL TECH**

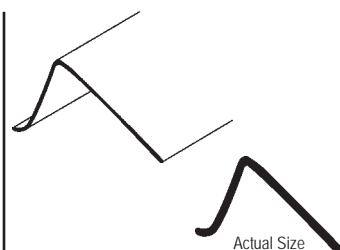

Part #	Color
65-481	Mill

**YALE**

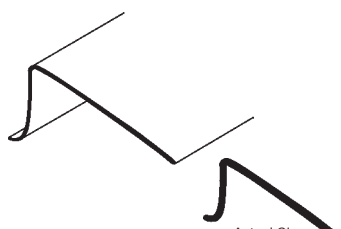

Part #	Color
65-463	White

**PGT**

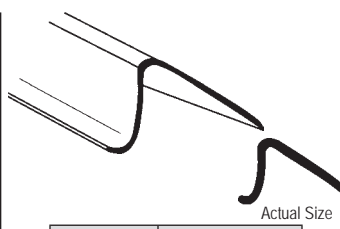

Part #	Color
65-477	Mill
65-477BZ	Bronze

**TUCKER**

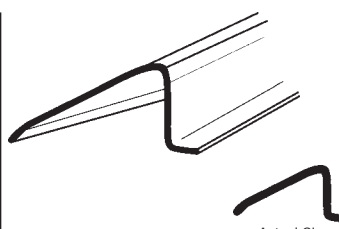

Part #	Color
65-478W	White

**PAN AM**

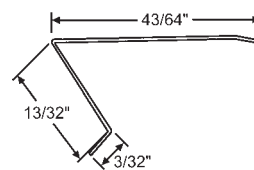

Part #	Color
65-543	Mill
65-543BZ	Bronze
65-543WH	White

6' Length, 10 Length Minimum

**AAA STAMPING**

## GRAY VINYL GLAZING SPLINE

Fits 80-85% of all spline type aluminum windows. Fits all type glazing spline.

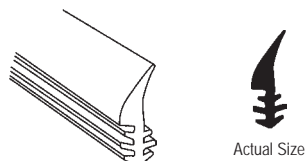

Part #	Length
68-1	100 ft.
68-1M	1,000 ft.

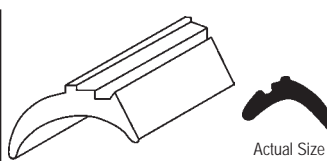

Part #	Length
68-2	100 ft.
68-2M	1,000 ft.

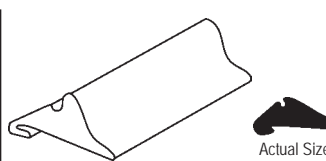

Part #	Length
68-3	100 ft.
68-3M	1,000 ft.

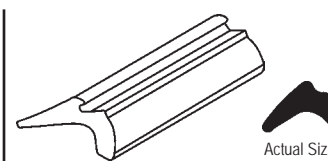

Part #	Length
68-4	100 ft.
68-4M	1,000 ft.

## VINYL GLAZING SPLINE

Fits 80-85% of all spline type aluminum windows. Fits all type glazing spline.

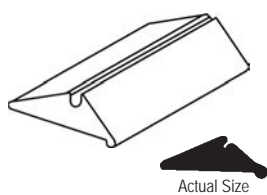

Part #	Length	Color
68-10	100 ft.	Gray
68-10M	1,000 ft.	Gray

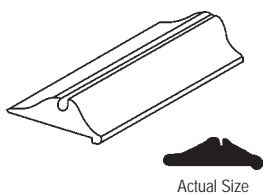

Part #	Length	Color
68-9	100 ft.	Gray
68-9M	1,000 ft.	Gray

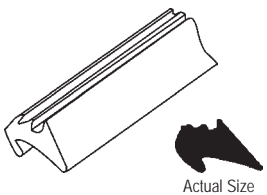

Part #	Length	Color
68-13	100 ft.	Gray
68-13M	1,000 ft.	Gray

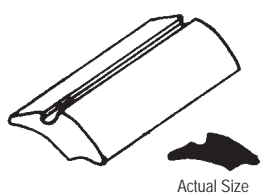

Part #	Length	Color
68-14	100 ft.	Gray
68-14M	1,000 ft.	Gray

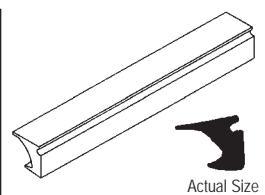

Part #	Length	Color
900-9465	100 ft.	Gray
900-9465B	100 ft.	Black

# WINDOW/DOOR GLAZING & WEATHERSTRIPPING

## GRAY VINYL GLAZING CHANNELS

Glazing Channel for Single Strength Glass 1/16" (1.6MM)

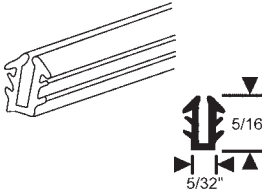

Part #	Length
67-5	100 ft.
67-5M	1,000 ft.

Channel Depth 17/64"  
Metal Opening 3/16" to 9/32"

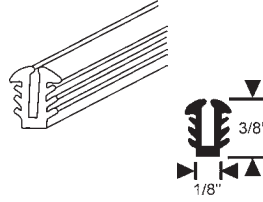

Part #	Length
67-7	100 ft.
67-7M	1,000 ft.

Channel Depth 11/32"  
Metal Opening 9/32"

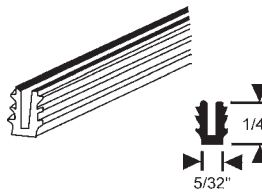

Part #	Length
67-2	100 ft.
67-2M	1,000 ft.

Channel Depth 13/64"  
Metal Opening 9/64" to 11/64"

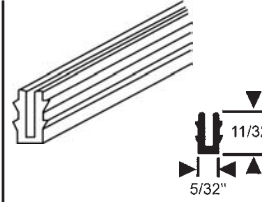

Part #	Length
67-6	100 ft.
67-6M	1,000 ft.

Channel Depth 9/32"  
Metal Opening 5/32" to 3/16"

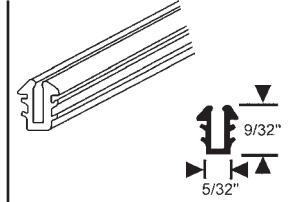

Part #	Length
67-1	100 ft.
67-1M	1,000 ft.

Channel Depth 15/64"  
Metal Opening 5/32" to 1/4"

## GRAY VINYL GLAZING CHANNELS

Glazing Channel for Double Strength Glass 1/8" (3.2MM) Minimal dimension changes may occur due to varying rubber components.

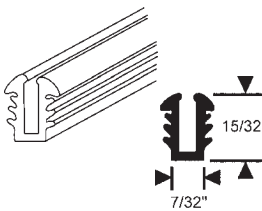

Part #	Length
67-9	100 ft.
67-9M	1,000 ft.

Channel Depth 9/32"  
Metal Opening 1/4" to 19/64"

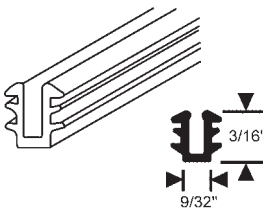

Part #	Length
67-10	100 ft.
67-10M	1,000 ft.

Channel Depth 15/64"  
Metal Opening 7/32" to 15/64"

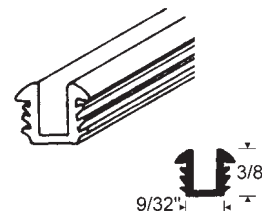

Part #	Length
67-14	100 ft.

Glazing Channel for 3/16" Glass

## BLACK VINYL GLAZING CHANNELS

Glazing Channel for 1/4" Glass

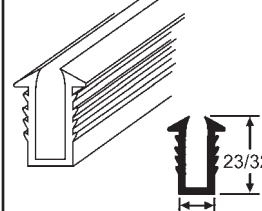

Part #	Length
67-35	500 ft.

Black

Glazing Channel for 1/2" Glass

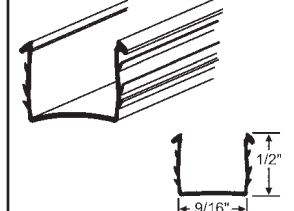

Part #	Length
900-9521	100 ft.

Black

## BLACK VINYL GLAZING CHANNELS

Glazing Channel for 1/2" Glass

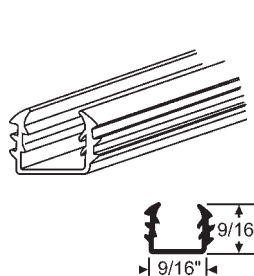

**67-31B**

Black. For 1/2" Glass.  
Sold in Multiples of 100'

Glazing Channel for 5/8" Glass

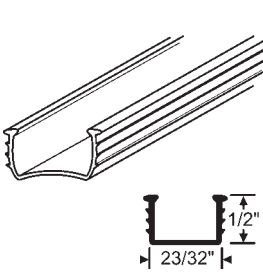

**900-21729NS**

Black. Sold in Multiples of 100'  
**ACORN 2300 SERIES**

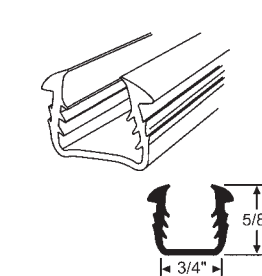

**900-21986**

Black. Sold in Multiples of 100'

## U-CHANNEL

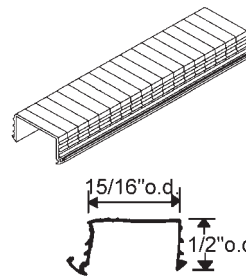

**67-18**

Black. Serrations spaced at 7/32"  
intervals. Sold in Multiples of 100'

## PERIMETER SEALS

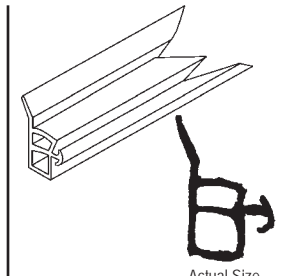

**900-17896**

Gray. Sold in Multiples of 100'

## PERIMETER SEALS

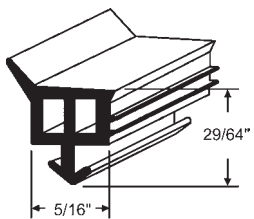

**900-8718**

Horizontal, Gray.  
Sold in Multiples of 100'

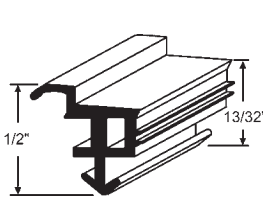

**900-11245**

Vertical, Gray.  
Sold in Multiples of 100'

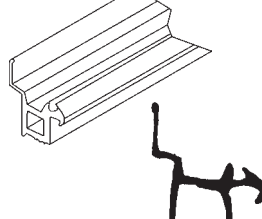

**900-9970**

Gray. Sold in Multiples of 100'

## GLAZING SPLINE WITH FLEXIBLE FIN

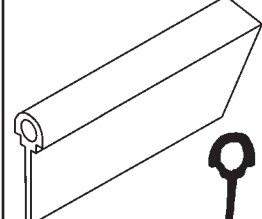

**900-15846**

Gray. Sold in Multiples of 100'

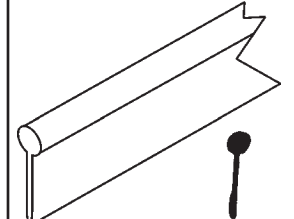

**900-16077**

Gray. Sold in Multiples of 100'

# WINDOW/DOOR GLAZING & WEATHERSTRIPPING

## LEAF WEATHERSEALS

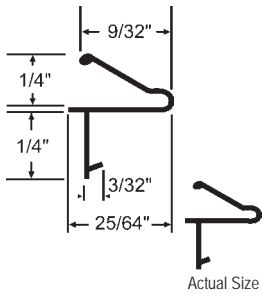

**63-310W**

White

7' Length - 20 Length Minimum

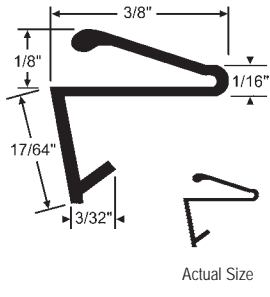

**63-183-96W**

White

8' Length - 10 Length Minimum

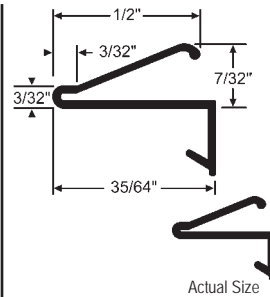

**900-20766TN**

Tan

7' Length - 20 Length Minimum

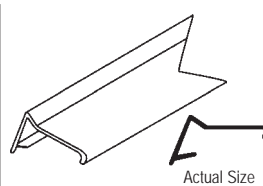

Actual Size

Part #	Color
65-75	Beige
65-75W	White

Used Primarily On Wood, Casement & Marvin Windows  
6' Length - 120' Minimum

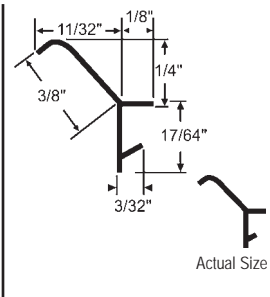

**63-313TN**

8' Length - 10 Length Minimum

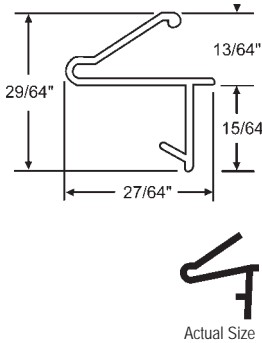

**900-20755**

7' Length - 20 Length Minimum

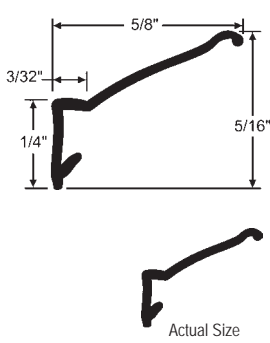

**900-20746TN**

8' Length - 10 Length Minimum

**MALTA**

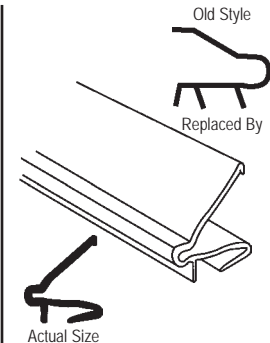

**63-381B**

Black. (6' Length) Order in Multiples of 6  
**PEACHTREE**

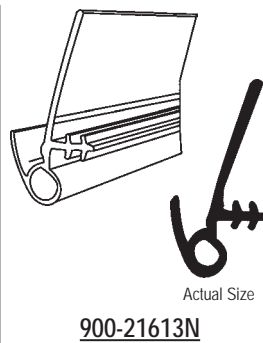

Actual Size

**900-21613N**

70". Black. Replaces Driftwood. Sold in Multiples of 5 Lengths. 5 Length Minimum  
**PEACHTREE**

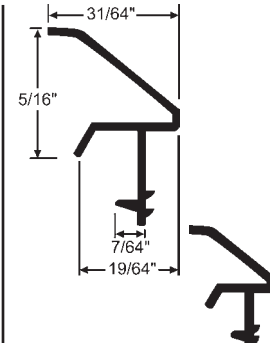

**63-327BZ**

Bronze  
**NORCO/JELD-WEN**

## FOAM "T" SLOT WEATHERSEAL

Superior operating ease. Outer cladding cuts friction in half. Superior resistance to compression set with one of a kind foam back formula. Superior backing. Slips into a T-Slot and stays there. No stretching, no shrinkage.

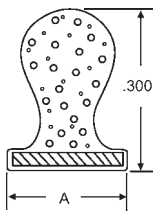

Part #	A
900-20383W	.190
900-20478W	.270

White. 100' Rolls

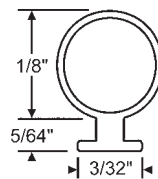

**63-171**

Black  
Sold in Multiples of 100'

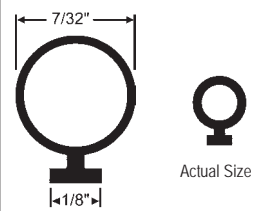

Actual Size

Part #	Color
63-247	Black

Vinyl. Sold in Multiples of 100'

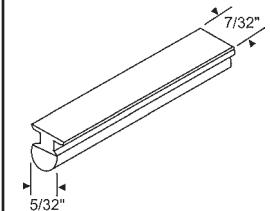

**900-20207**

Black Vinyl. Sold in Multiples of 100'

**SEASONALL/SILVERLINE**

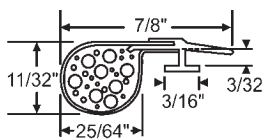

**63-202W**

White

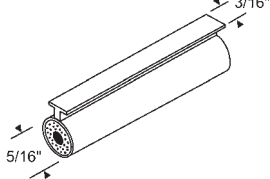

**900-20230**

Foam Filled White Vinyl Bubble Seal. Sold in Multiples of 100'  
**SEASONALL**

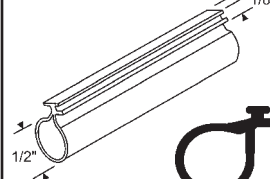

**900-20281W**

White. Sold in 8' Lengths. Minimum 15 Lengths  
**SEASONALL**

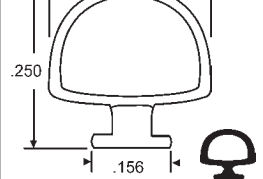

Actual Size

**900-18224**

"T" Slot Extruded Vinyl  
Black. Sold in Multiples of 100'

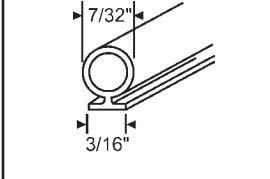

**63-429B**

Black Vinyl. Sold in Multiples of 100'

# WINDOW/DOOR GLAZING & WEATHERSTRIPPING

## WEATHERSTRIP

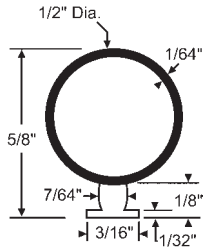

**900-21430**  
White

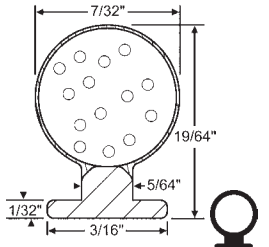

**63-425B**  
.187 Backing X .300 Height.  
Sold by ft. in multiples of 100'  
Rolls. Black.

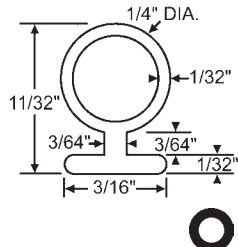

**900-15702**  
Gray  
**PAN AM**

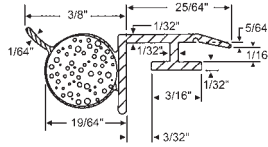

**63-323W**  
Offset Foam Bulb T-Slot  
Weatherseal. White

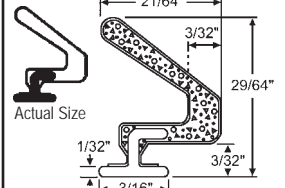

Part #	Color
63-379B	Black
63-379GY	Gray

Q-Lon Weatherseal  
**SCHLEGEL**

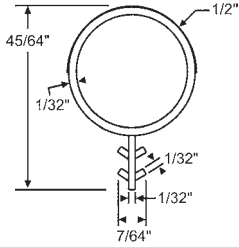

Part #	Color
63-288W	White
63-288B	Black
63-288BG	Beige

Sold in Multiples of 100'

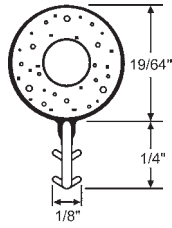

Part #	Color
63-513TN	Tan

Sold in Multiples of 100'

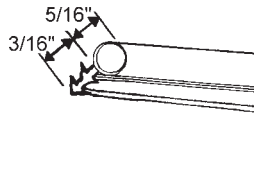

**900-10041**  
Tan. Sold in Multiples of 50'

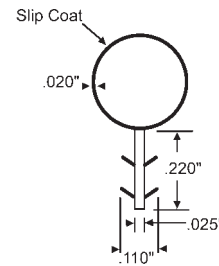

.300 Bulb Diameter

Part #	Color
63-150BG	Beige
63-150W	White
63-150BL	Black

.250 Bulb Diameter

Part #	Color
63-164	Beige
63-164W	White
63-164B	Black

Sold in Multiples of 100'

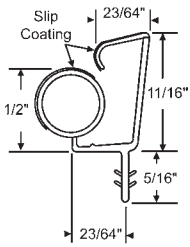

**63-208-82BZ**  
Bronze Vinyl. 82" Long.  
10 Length Minimum  
**PREMDOR/THERMA-TRU**

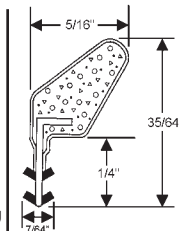

Part #	Color
63-215BZ	Bronze
63-215W	White

Sold in Multiples of 100'

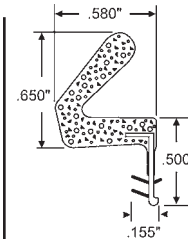

Part #	Color	Length
63-181BZ-82	Bronze	82"
63-181BG-82	Beige	82"
63-181W-82	White	82"

Sold in Multiples of 10 Lengths Min.

**SCHLEGEL**

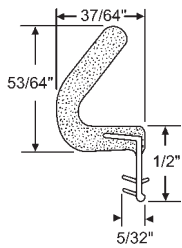

**63-283BZ**  
Door Weatherseal. 97"  
Bronze. Sold in Multiples of  
10 Lengths Min.

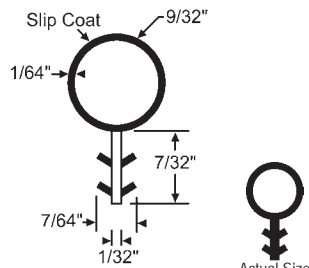

**63-274W**  
White

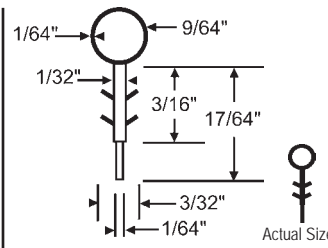

Part #	Color
63-193W	White
63-193	Beige

**VEKA**

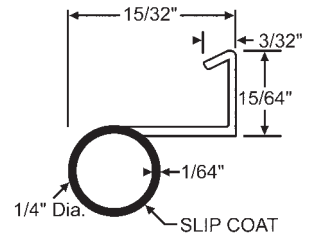

**63-177BG**  
Beige. Rigid Kerf Leg.  
Sold in Multiples of 100'

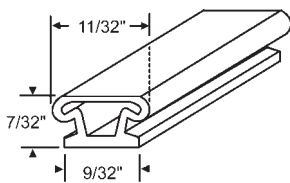

Part #	Color
63-360B	Black

Sold in Multiples of 100'

**ACORN**

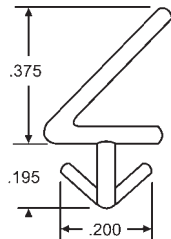

**63-170**  
White. Extruded Vinyl.  
Sold in Multiples of 100'

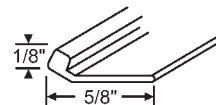

Part #	Color
63-502B-1	Black
63-502GY-1	Gray

Sold By 100' Roll

**PAN AM**

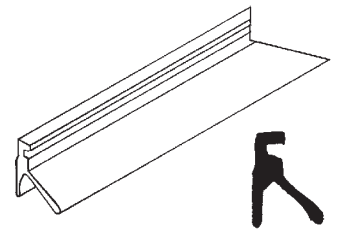

**900-19465**  
Gray. Sold By 100' Roll

# WINDOW/DOOR GLAZING & WEATHERSTRIPPING

## WEATHERSTRIP

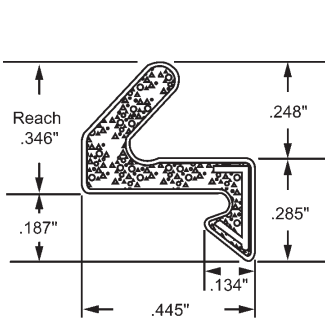

**63-207**

White

Sold in Multiples of 100'

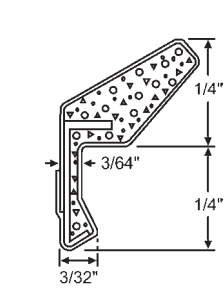

Part #	Color
63-221BZ	Bronze
63-221W	White

Sold in 150' Roll

**SCHLEGEL**

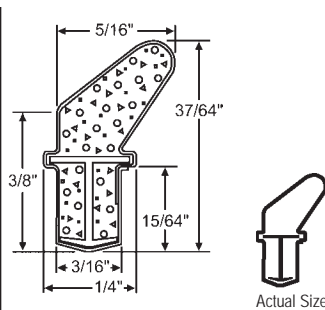

Actual Size

Part #	Color
63-385W	White
63-385BZ	Bronze

Sold in Multiples of 100'

**SCHLEGEL**

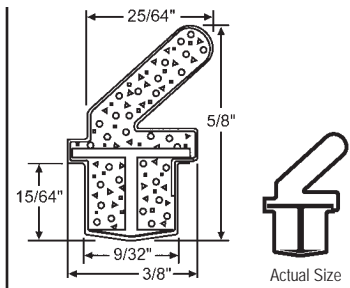

Actual Size

Part #	Color
63-391W	White
63-391BG	Beige

Q-LON Foam Seal Weatherstrip  
Sold in Multiples of 100'

**CARADCO/POZZI SILVERLINE**

## ADHESIVE-BACKED FOAM DOOR SEAL

- The seal is composed of a cellular foam core and is clad in an embossed, non-vinyl, painted resistant liner.
- Door seal is for kerfless applications.
- One profile seals the strike side, hinge side and header while maintaining a tight seal.
- Note: Recommended temperature for installation not less than 40° F.
- Door seal comes in 82" lengths and sold in multiples of 10 lengths.

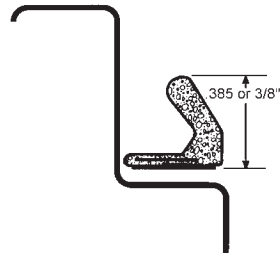

Part #	Color
63-236BZ	Bronze
63-236W	White
63-236B	Black

## NAIL-UP FOAM DOOR SEAL

- Nail-up door seal set can be used for both wood and metal doors.
- Can also be used for leaking windows.
- Door seal comes in 7 ft. lengths and sold in multiples of 10 lengths.

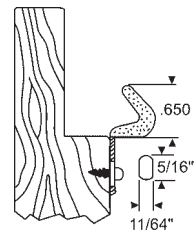

Part #	Color
900-18139BX	Brown
900-18139WX	White

## DOOR SWEEP

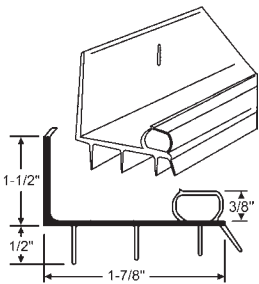

Part #	Color	Length
900-16933	Beige	35-11/16"
900-16933BZ	Bronze	35-11/16"
900-16933W	White	35-11/16"
900-16933W-32	White	31-11/16"

**BENCHMARK/GENERAL PRODUCTS**

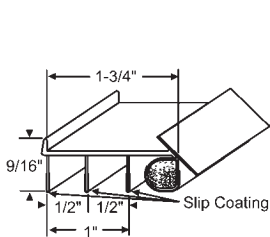

**900-20750-36**

Bronze Vinyl  
36" Long

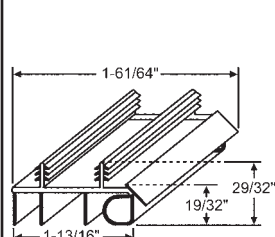

Part #	Color	Length
900-22371	Bronze	34-17/32"
19-342BG-36	Beige	36"
19-342BG-48	Beige	48"
19-342BZ-36	Bronze	36"
19-342BZ-48	Bronze	48"

**Malta**

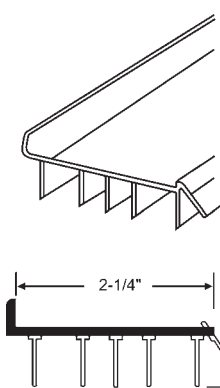

Part #	Color	Length
19-447BZ-36	Bronze	36"
19-447BZ-48	Bronze	48"

for 2-1/4" Doors

**Field Performance**

- Sure Seal (5) Fin Design
- Flexible to -25 Degrees F.
- Moisture Drip Fin
- Rigid PVC Base Retains Shape
- Extra Tough, Flexible PVC, Tear Resistant Fins

**Installation Performance**

- Universal Fit: Steel, Fiberglass & Wood Doors
- Staple Mount
- Split Resistant PVC
- Inside Door Mounting Lip

## FOAM DOOR SEALS



Part #	Finish
900-8179	White
900-8179M	Mill
900-8179B	Brown
900-8179BLK	Black

Overall length including vinyl is 37".

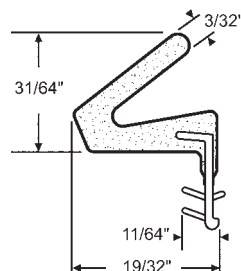

Part #	Color	Length
900-9176BZ	Bronze	82"
900-9176W	White	82"

Fire Rating: UL Rated for up to 180 Minutes. Sold in Multiples of 10 Lengths Min.



# WINDOW/DOOR GLAZING & WEATHERSTRIPPING

## SKIRTING WEATHERSEAL

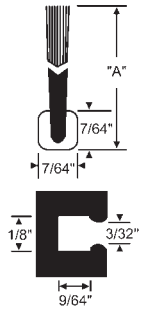

Part #	A	Finish
900-17451	.430	Gray
900-17452	.530	Gray
900-17453	.630	Gray

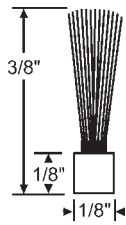

**63-453**  
Gray. Sold in 100' Spools

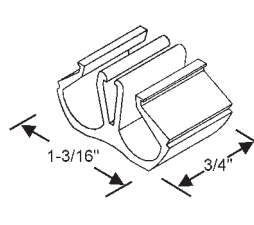

**90-572**  
White Plastic  
"Double"

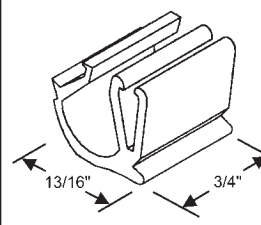

**90-573**  
White Plastic  
"Single"

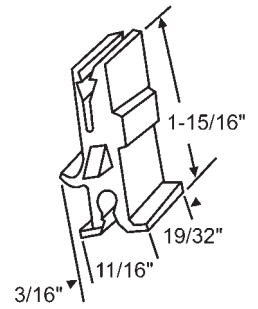

**900-5371**  
Plastic  
**ALSCO ANACONDA**

## ADHESIVE FOAM WEATHERSTRIPPING TAPE

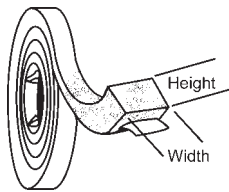

Part #	Size	Material	Color
63-151	3/8" Wide x 3/16" High x 17'	Vinyl, Closed Cell	Gray
63-152	1/2" Wide x 3/8" High x 10'	Vinyl, Closed Cell	Gray

## FOAM CORNER SEALS

Q-Lon® Door Seal made of open-cell urethane foam core and clad in embossed polyethylene. Strike jamb and hinge jamb sill corners. One profile seals the strike side, hinge side and header while maintaining a tight seal.

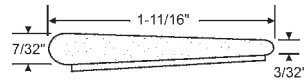
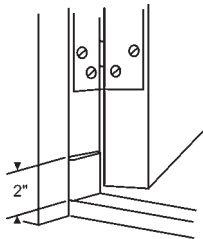

Part #	Color
63-192W-2	White
63-192-2	Bronze
63-192BG-2	Beige

2" Lengths

Part #	Color
63-192W-96	White
63-192-96	Bronze
63-192BG-96	Beige

96" Lengths

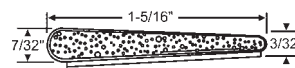

Part #	Color
63-345-2	Bronze

2" Lengths

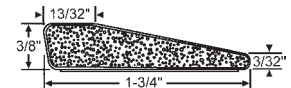

Part #	Color
63-296-2	Bronze

2" Lengths

## MAGNETIC WEATHERSTRIP REPLACEMENT FOR STEEL DOORS

Metal door replacement set consists of magnetic and compression pieces which fit into existing kerf around the door frame. Seals completely against drafts, dirt and moisture.

Packed 6 Per Carton

Set consists of:

- 1 pc. - 6' 8" Magnetic Weatherstrip
- 1 pc. - 3' Magnetic Weatherstrip
- 1 pc. - 6' 8" Compression Weatherstrip

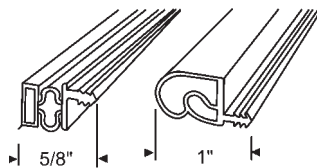

Part #	Color
900-9000S	White
900-9000SBG	Beige
900-9000SBZ	Bronze

## E.Z.D. GLAZING TOOL



Part #	Description
59-79	E.Z.D. Glazing Tool
59-79G	Hand Guard Replacement
59-79X	Blade Replacement

1. The Tool was designed to assist in the Deglazing of Glass from Residential Vinyl Windows. The most common glazing systems include foam tape, silicone, and butyl tape. It was not designed for some of the newer glazing compounds which are extremely hard and strong. It is not recommended for the deglazing of commercial units.
2. The Blade is designed to lay flat on the surface of the glass and slide into the glazing pocket. Tests have shown that a small amount of soapy water will facilitate this action. Once the tool is inserted into the glazing pocket, the wheel will roll through the glazing material much the same as a pizza cutter rolls through a pizza.
3. After the entire perimeter of the unit has been cut, the glass may be removed by applying gentle pressure to each corner with a putty knife or similar instrument. Do not use the tool in the corner because the torque applied will shorten the life of the tool substantially and may result in injury to the user.

Note: While the hand guard does provide some measure of protection from broken glass it is recommended the user always wear safety glasses and gloves when using the tool. The tool should be stored in its plastic bag when not in use.

# WINDOW/DOOR GLAZING & WEATHERSTRIPPING

## ENTRASEAL DOOR ASTRAGAL SEALS

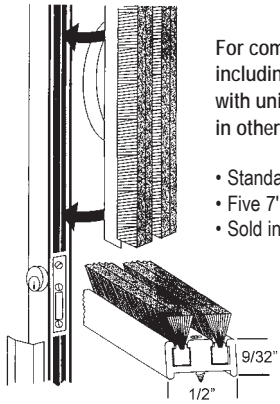

For commercial/entrance doors, including wood doors. Designed with unique features not available in other astragals.

- Standard pile height -.480"
- Five 7' lengths per tube.
- Sold in Multiples of 5.

### 63-500

Profile for Kawneer Door shown  
Black

## GRAY REPLACEMENT FIN WEATHERSTRIPPING

### 3/16" (.187) Backing Width

Pile Height	100 Ft.	500 Ft.	Misc.
.170 (11/64)	63-76	63-77	63-78-4.5 (4500')
.200 (13/64)	63-7	63-8	63-9R (4000')
.230 (15/64)	63-82	63-83	63-84-3.5 (3500')
.260 (17/64)	63-85	63-86	63-87-3 (3000')
.290 (19/64)	63-25	63-26	63-27R (3000')
.320 (21/64)	63-94	63-95	63-96R (2500')
.350 (23/64)	63-34	63-35	

### 17/64" (.270) Backing Width

Pile Height	100 Ft.	500 Ft.	Misc.
.170 (11/64)	63-40	63-41	63-42R (3500')
.200 (13/64)	63-46	63-47	63-48-3 (3000')
.230 (15/64)	63-52	63-53	63-54-2.5 (2500')
.260 (17/64)	63-112	63-113	63-114-2.5 (2500')
.290 (19/64)	63-61	63-62	63-63-2 (2000')
.320 (21/64)	63-121	63-122	63-123-2 (2000')
.350 (23/64)	63-70	63-71	63-72R (1500')

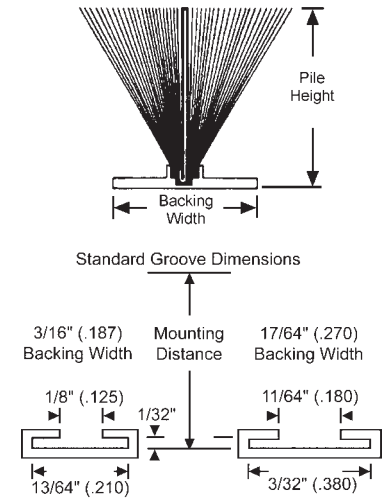

Additional backing sizes available: 23/64", 27/64", 1/2"

## WEATHERSTRIPPING WITH ADHESIVE BACKING

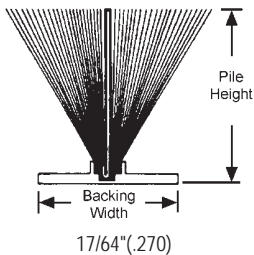

Part #	Length
63-49TP	100 ft. roll
63-51TP	1,000 ft. roll

7/32" (.220) Pile Height

Part #	Length
63-55TP	100 ft. roll
63-57TP	1,000 ft. roll

1/4" (.250) Pile Height

Other Sizes Available Upon Request With Minimum Orders

## MISC

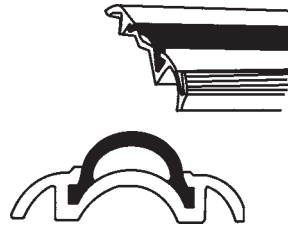

### 900-13005

36" Replacement Threshold Insert  
Gray, Vinyl

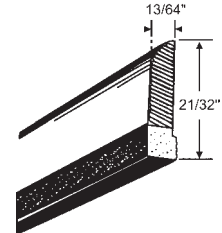

### 900-14942

Wood & Vinyl Foam Door Set  
2 pc. 7' Long, 1 pc. 3' Long

## EDGETECH SUPER SPACER

# Edgetech Super Spacer

Super Spacer® Premium Plus is a flexible, silicone foam spacer product. Super Spacer® provides the maximum in perimeter insulation for sealed glazing units and prevents condensation. Desiccant-filled with pre-applied side adhesive, the structural foam spacer significantly simplifies insulating glass (IG) production.

Featuring a vapor barrier backing, the product must be used in combination with conventional IG sealants such as hot melt butyl, polyurethane and solvent-free polysulfide. Dual seal equivalent sealants may also be used.

### 1/4" Thick Super Spacer Premium Plus

Gray	Black	Width	Reel Size
92-503	92-503B	1/4"	66'
92-503X	92-503XB	1/4"	1100'
92-504	-	5/16"	66'
92-504X	-	5/16"	1100'
92-505	92-505B	3/8"	66'
92-505X	92-505XB	3/8"	900'
92-507	-	1/2"	66'
92-507X	-	1/2"	700'
92-509	-	5/8"	66'
92-509X	-	5/8"	575'
92-512X	-	13/16"	400'

## Edgetech New & Improved Energy efficient Super Spacer® Premium Plus.

### Enhanced Features Include:

- Up to 30% lower thermal conductivity
- Superior long-term durability
- The warmest edge of glass temperature
- The highest NFRC Condensation Resistance rating

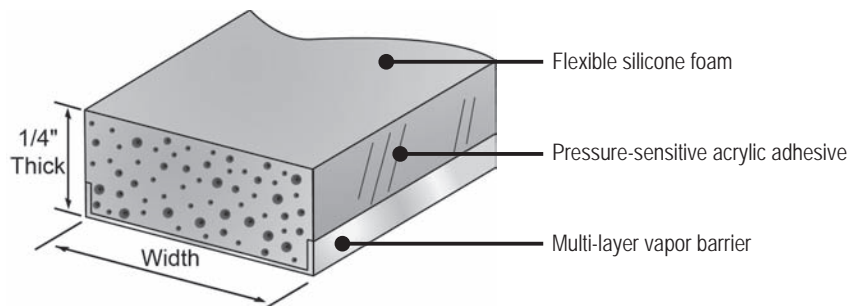

# WINDOW/DOOR GLAZING & WEATHERSTRIPPING

## ADHESIVE SEALANT



- Adheres To**
- Vinyl • Aluminum • Wood • Steel
  - Brick • Concrete • Stone • Ceramics
  - Fiberglass • Masonry • Building Paper

- Product Description**
- Waterproof, Premium All-Weather Silicone
  - Excellent Tooling Characteristics
  - UV and Mildew Resistant
  - Permanently Flexible
  - Will Not Shrink, Crack, Sag or Slump
  - Service Temperature -40°F to +400°F
  - Application Temperature +32°F to +120°F

### Flex Facts

- Permanently flexible
- Will not shrink & crack
- Will not sag or slump
- Weather tight seal
- Excellent adhesion to all building substrates
- Waterproof
- Mold/Mildew resistant
- Easily gunned at all temperatures—Winter and Summer
- VOC compliant in all 50 states
- Excellent tooling
- Low odor

# NOVA FLEX SILICONE

When You Want the Seal to Last

Part #	Color
59-100	Clear
59-100W	White



**Other colors available in carton only (12 per carton): Blue White, Antique White, Canvas, Black, Gray, Dark Bronze, Lincoln Bronze, Imperial Brown, Earthtone, Terratone, Dark Sand, Beige, Tan, Almond, Sandstone, Forest Green**

- Solvent free
- Invisible to UV light
- Tack free in 10 minutes
- Completely cured within 2 days
- AAMA verified for all Window installations
- Will not freeze
- Can be used on interior and exterior
- Plastic tubes-will not fall apart
- Removable tips-No wasted sealant left in fixed tips
- Ability to use entire tube-or can save with end cap - No waste
- Available in all major siding and window manufacturer colors

## CAULKING APPLICATORS/FOAM GUNS



### 59-102

9" Caulking gun

- Half Pipe with Hardened Push Rod
- Half Pipe with Hardened Ratchet Teeth
- For cartridges 310ml / 10.5 fl oz
- Color: Blue



### 59-104

Half Pipe Caulking Gun

- Half Pipe with Rotary Carriage
- Ladder Hook
- Anatomically Shaped Lever
- Tip Cleaner
- For cartridges 310ml / 10.5 fl oz
- Color: Red/Black



### 59-105

Pro Half Pipe Caulking Gun

- Very Sturdy Half Pipe Caulking Applicator
- Rotary Carriage and Ladder Hook
- Special Hardened Catch Plate
- Double Side Bearings for Smooth Running Function
- For High Viscosity Dispensing Material
- Thrust ratio 17:1.
- For cartridges 310ml / 10.5 fl oz
- Color: Black/Turquoise



### 59-106

Pro Caulking Applicator

- Very Sturdy Aluminum Barrel Applicator
- Rotary Barrel and Ladder Hook
- Special Hardened Catch Plate
- Pro Push Plate for Complete Output of Sausages
- Double Slide Bearings for Smooth-Running Function
- For High Viscosity Dispensing Material
- Thrust ration 17:1
- For cartridges 310ml / 10.5 fl oz and sausages 400ml / 11.6 fl oz or 620ml / 20.9 fl oz
- Color: Silver/Black/Turquoise



### 59-110

Pro Caulking Applicator

- Very Sturdy Aluminum Barrel Applicator
- Rotary Barrel and Ladder Hook
- Special Hardened Catch Plate
- Pro Push Plate for Complete Output of Sausages
- Double Slide Bearings for Smooth-Running Function
- For High Viscosity Dispensing Material
- Thrust ration 17:1
- For cartridges 310ml / 10.5 fl oz and sausages 400ml / 11.6 fl oz
- Color: Silver/Black/Turquoise



### 59-108

Caulking Applicator Aluminum

- Sturdy Dispensing Applicator
- Strong Catch Plate
- Aluminum Barrel and Screw Caps
- For cartridges 310ml / 10.5 fl oz, sausages 400ml / 11.6 fl oz and sausages 600ml / 20.2 fl oz
- Color: Silver/Black

# WINDOW/DOOR GLAZING & WEATHERSTRIPPING

## CAULKING APPLICATORS/FOAM GUNS



**59-107**

PU Foam Gun

- Light-Weight Plastic/Aluminum Foam Gun
- Metal Tube and Lever
- Big Adjusting Screw for Excellent Justification
- Ergonomically, Rubberized Handle
- Color: Red/Black



**59-109**

PU Foam Gun

- Solid Metal Foam Gun
- PTFE Coated Needle and Can Adaptor.
- Large Brass Adjusting Screw
- Tapered Extrusion Tube for High Stability
- Rubberized Handle for Superior Grip
- Color: Black/Red/Silver

## GLASS CLEANER

Spray X Glass Cleaner contains less water and more cleaning power. Our patent pending formulation allows us to meet the current VOC regulations and deliver maximum cleaning performance for our customers. Compare our alcohol content to other national brands and you'll notice our quality is significantly higher

Spray X Glass Cleaner uses SD-40B cosmetic grade alcohol that is 200 proof and 99.9% pure. This type of alcohol requires a registration with the US Department of Alcohol, Tobacco and Firearms, and each Spray-X Glass Cleaner can is marked with our registration number. Compare our registration to other brands and you'll quickly agree this product has been performance engineered to meet all your glass cleaning needs.

Spray X Glass Cleaner for cleaning and polishing glass, mirrors and other nonporous surfaces. This easy-to-use, fast-acting product uses clinging foam to break up soils and hold them -even on vertical surfaces. There's no dripping, no running and no streaking. With an exclusive industrial strength formulation, this product cleans thoroughly, dries quickly, requires no rinsing and leaves a pleasant, fresh aroma.

Spray-X Glass Cleaner utilizes a 360 degree valve for ease of use. This allows our product to be sprayed right side up or upside down. Other brands cannot spray upside down, but we have this solid valve feature, plus the anti-fatigue finger pad makes this packaging very attractive to all users.

Spray-X Glass Cleaner is alcohol based. It does not contain ammonia. When comparing our performance on tinted glass to ammoniated brands most professional installers praise the difference.

Spray-X Glass Cleaner is packaged in a two-piece steel can. No side seam means we use less energy and material and generate less waste. Our can weighs 10% less than the three-piece equivalent and is 100% recyclable. You will appreciate the new contemporary can design.



**Foaming Glass Cleaner**

**59-101**

19 oz. can

12 cans per case

- Industrial Strength
- The most versatile glass cleaner available
- Cleans glass, windows, mirrors, windshields, enamel surfaces, chrome, tile, porcelain and other hard surfaces.
- Sprays in any position
- Dissolves dirt, grease, grit and grime
- Heavy-Duty Foam clings to vertical surfaces
- Non-ammoniated
- Guaranteed to leave no film - "Streak Free"
- Safe on tinted glass, plastic and mirrors
- Contains cosmetic-grade alcohol for best performance
- Superior quality at competitive pricing
- Patent Pending Formulation

## PRIVATE LABEL SPRAY-X FOAMING GLASS CLEANER

**"Private Label Spray-X Foam Glass Cleaner as your own!!"**



**59-101P**

19 oz. can

540 Can Minimum  
(45 Cases, 12 cans per case)

- Guaranteed to Leave No Film- "Streak Free"
- Industrial Strength
- Cleans Glass, Windows, Mirrors, Windshields, Enamel Surfaces, Chrome, Tile Porcelain and Other Hard Surfaces
- Sprays in Any Position
- Dissolves Dirt, Grease Grit and Grime
- Heavy-Duty Foam Clings to Vertical Surfaces
- Non-Ammoniated
- Contains Cosmetic-Grade Alcohol for Best Performance
- Superior Quality at Competitive Pricing
- Advanced Formulation
- Available in 19oz



SW

↑  
Straight Wall  
↓



← Piece 1  
Top Chime and Dome

← Piece 2  
Can Wall

← Piece 3  
Bottom Chime

## CUSTOM MADE STANDARD ROLL FORM ALUMINUM WINDOW SCREEN ORDER FORM

Account# \_\_\_\_\_

Page# \_\_\_\_ of \_\_\_\_

Sold To: \_\_\_\_\_

Ship To: \_\_\_\_\_

\_\_\_\_\_  
 \_\_\_\_\_  
 \_\_\_\_\_

\_\_\_\_\_  
 \_\_\_\_\_  
 \_\_\_\_\_

Salesman \_\_\_\_\_ Supervisor \_\_\_\_\_ Purchase Order# \_\_\_\_\_

Date \_\_\_\_\_ Quoted By \_\_\_\_\_ Customer # \_\_\_\_\_

### STEP 1 Measurement

\_\_\_\_\_ " Width x \_\_\_\_\_ " Height

Note: On all screen frames screen measurements must be box to box.

Note: Maximum screen size is 45" x 80". Can not process orders for any screens larger than 45" x 80".

### STEP 2 Identify Frame part # \_\_\_\_\_

### STEP 3 Select frame finish.

Mill \_\_\_\_\_ White \_\_\_\_\_ Almond \_\_\_\_\_ Beige \_\_\_\_\_  
 Bronze \_\_\_\_\_ Other \_\_\_\_\_

### STEP 4 Select wire.

Charcoal Fiberglass (Standard) \_\_\_\_\_ Gray Fiberglass \_\_\_\_\_  
 Bright Aluminum \_\_\_\_\_ Charcoal Aluminum \_\_\_\_\_  
 Pet Screen \_\_\_\_\_ Other \_\_\_\_\_

### STEP 5 Crossbrace location

Required \_\_\_\_\_ Not Required \_\_\_\_\_

Horizontal: \_\_\_\_\_ inches up from the bottom

Vertical: \_\_\_\_\_ inches from the right rail

### STEP 6 Type of Corner Keys

Plastic External Square Cut (Standard) \_\_\_\_\_

Plastic Internal Mitered \_\_\_\_\_

Plastic External Mitered (Andersen Style) \_\_\_\_\_

**Note: Unless otherwise specified, all custom made window screens are manufactured with external plastic corner keys.**

### STEP 7 Hardware: Required \_\_\_\_\_ Not Required \_\_\_\_\_

### STEP 8 Woolpile (if needed) specify height:

.280  .470

**Specify Rail:**  Head  Sill  Left  Right

### STEP 8 Measure location of hardware and specify on drawing.

Always determine hardware location from the end of corner to either center or pivot point depending on type of hardware.

**Show Hardware Locations  
 (Inside Looking Out / Spline on Outside)**

Fill out the positioning of the hardware below.

Location	Quantity	Number	Position - Number of inches from end (tip or corner)
• Installed on HEAD RAIL			
• Installed on SILL RAIL			
• Installed on LEFT RAIL			
• Installed on RIGHT RAIL			

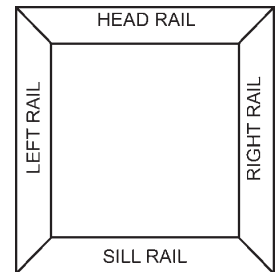

Part#	Quantity (see note below)	Size	Price Each	Amount
990-999		" width <b>X</b> " height		
890-999-1		Window Screen Packaging Charge	\$ _____	
<b>Note: Minimum 2 screens per size &amp; color</b> Note: On all screen frames screen measurements must be box to box. Note: Maximum screen size is 45" x 80". Can not process orders for any screens larger than 45" x 80".			<b>TOTAL</b>	
			<b>FREIGHT</b>	

### STEP 9 All Custom made window screen orders will not be processed without customer's signature verifying acceptance of our terms and conditions of order.

I understand that this material is not regular stock, but custom made to specifications as stated above. I understand and accept the condition that this material is NON-RETURNABLE and NON-CANCELABLE. A packaging charge per screen will be assessed for quantities less than 10 of a size. IT IS THE RESPONSIBILITY OF THE CUSTOMER TO INSPECT FOR DAMAGE, AND MAKE THE CLAIM WITH THE CARRIER, AS WE ARE NOT RESPONSIBLE FOR DAMAGE.

**Please Note: For all truck deliveries there is a minimum floor charge. There is an additional charge for residential deliveries.**

Signature of Authorized Buyer \_\_\_\_\_ Buyer Phone \_\_\_\_\_ - \_\_\_\_\_

Title \_\_\_\_\_

# SCREEN HARDWARE

## CUSTOM MADE WINDOW SCREENS

### ROLLED FORMED ALUMINUM FRAME SIZES

See Following Pages for Components

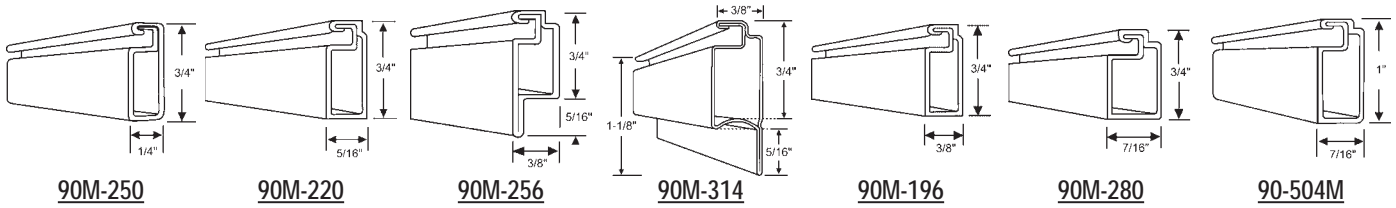

## ALUMINUM FRAME ACCESSORIES

**.019 GAUGE**

Part #	Color
90M-250	Mill
90M-251	White
90M-252	Dark Bronze

**FIXED PIN**

**900-21792**  
5/32"x1-1/8"

**HAIR PIN CLIP**

**90-127**

**TENSION SPRING**

**900-17211**

**LOOP LATCH**

**90-103X**  
Spline Type

**PULL TABS**

Part #	Color
900-12883	Clear
900-12883B	Black

Nylon - Lays Flat

**PULL TABS**

Part #	Description
90-633	Black rubber flexible
90-634	Black vinyl rigid
90-634G	Gray vinyl rigid

**PULL TABS**

Part #	Color
90-118	Mill
90-118WH	White
90-118BZ	Bronze

Aluminum

**.019 GAUGE**

Part #	Color
90M-220	Mill
90M-221	White
90M-222	Dark Bronze

**5/32" PLUNGER ASSEMBLIES**

Part #	Cap Color
90-635	White
90-635B	Black

**5/32" PLUNGER ASSEMBLIES**

Part #	Cap Color
90-635FT	White
90-635BFT	Black

Flip Type

**7/32" PLUNGER ASSEMBLIES**

Part #	Cap Color
900-9850	White
900-9850B	Black

**7/32" PLUNGER ASSEMBLIES**

Part #	Cap Color
900-9850FT	White
900-9850BFT	Black

Flip Type

**FIXED PIN**

Part #	Description
900-21792	5/32"x1-1/8"
900-21747	7/32"x1-1/8"

**BUTTERFLY LATCH**

**90-506**

**LOOP LATCH**

**90-103X**  
Spline Type

**HAIR PIN CLIP**

**90-127**

**SWIVEL CLIP**

Part #	Color
90-380B	Black
90-380WH	White

## CUSTOM MADE WINDOW SCREENS

### CORNER SPRING

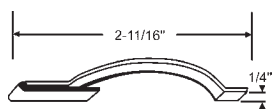

**90-498**

### TENSION SPRING

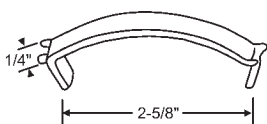

**16-158**

### PULL TABS

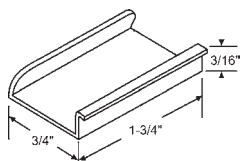

Part #	Color
90-118	Mill
90-118WH	White
90-118BZ	Bronze

Aluminum

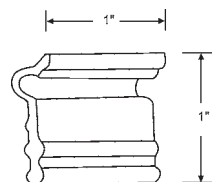

Part #	Description
90-633	Black rubber flexible
90-634	Black vinyl rigid
90-634G	Gray vinyl rigid

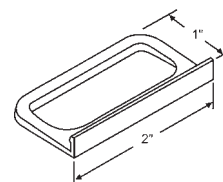

Part #	Color
900-12883	Clear
900-12883B	Black

Nylon - Lays Flat

### .019 GAUGE

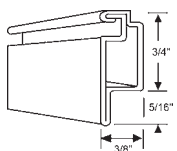

Part #	Color
90M-256	Mill
90M-257	White
90M-258	Dark Bronze

Can be used with frame  
90M-196, 90M-197 & 90M-198

### 5/32" PLUNGER ASSEMBLIES

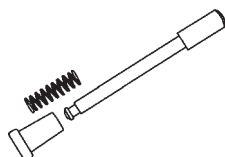

Part #	Cap Color
90-635	White
90-635B	Black

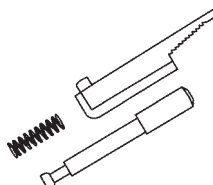

Part #	Cap Color
90-635FT	White
90-635BFT	Black

Flip Type

### FIXED PIN

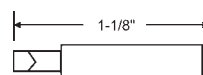

**900-21792**  
5/32"x1-1/8"

### HAIR PIN CLIP

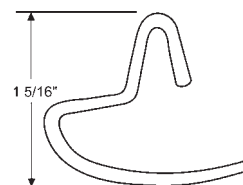

**90-127**

### LOOP LATCH

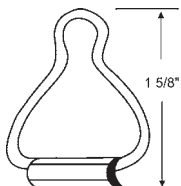

**90-103X**  
Spline Type

### POINTER LATCH

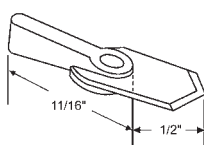

Part #	Color
900-9823	Black
900-9823W	White

### CORNER SPRING

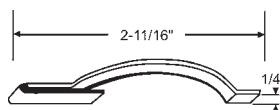

**90-498**

### TENSION SPRING

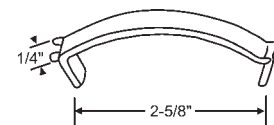

**16-158**

### PULL TABS

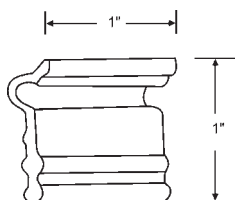

Part #	Description
90-633	Black rubber flexible
90-634	Black vinyl rigid
90-634G	Gray vinyl rigid

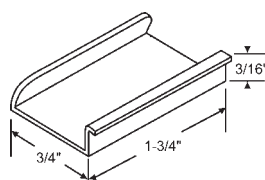

Part #	Color
90-118	Mill
90-118WH	White
90-118BZ	Bronze

Aluminum

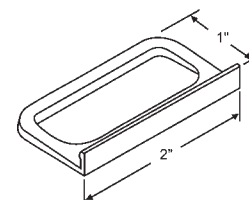

Part #	Color
900-12883	Clear
900-12883B	Black

Nylon - Lays Flat

### .019 GAUGE

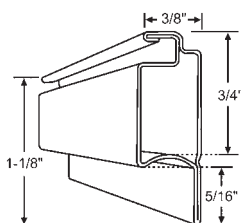

Part #	Color
90M-314	White
90M-313AD	Almond
90M-315	Bronze

A Good Substitute For Bayform  
Series B38LI Frame

### 5/32" PLUNGER ASSEMBLIES

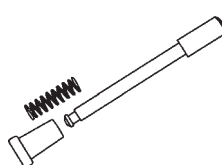

Part #	Cap Color
90-635	White
90-635B	Black

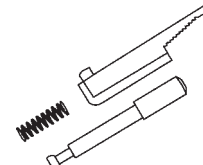

Part #	Cap Color
90-635FT	White
90-635BFT	Black

Flip Type

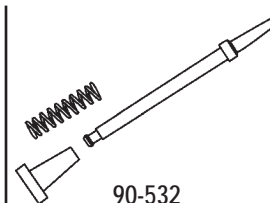

**90-532**

# SCREEN HARDWARE

## CUSTOM MADE WINDOW SCREENS

**.019 GAUGE**

Part #	Color
90M-196	Mill
90M-197	White
90M-198	Dark Bronze

**5/32" PLUNGER ASSEMBLIES**

Part #	Cap Color
90-635	White
90-635B	Black

Part #	Cap Color
90-635FT	White
90-635BFT	Black

Flip Type

**7/32" PLUNGER ASSEMBLIES**

Part #	Cap Color
900-9850	White
900-9850B	Black

Part #	Cap Color
900-9850FT	White

Flip Type

**FIXED PIN**

Part #	Description
900-21792	5/32"x1-1/8"
900-21747	7/32"x1-1/8"

**BUTTERFLY LATCH**

**90-506**

**LOOP LATCH**

**90-103X**  
Spline Type

**HAIR PIN CLIP**

**90-127**

**CORNER SPRING**

**90-498**

**TENSION SPRING**

**16-158**

**PULL TABS**

Part #	Color
900-12883	Clear
900-12883B	Black

Nylon - Lays Flat

Part #	Color
90-118	Mill
90-118WH	White
90-118BZ	Bronze

Aluminum

Part #	Description
90-633	Black rubber flexible
90-634	Black vinyl rigid
90-634G	Gray vinyl rigid

Part #	Color
90-376	Black
90-376GY (1831A)	Gray

Vinyl

**.019 GAUGE**

Part #	Color
90M-280	Mill
90M-281	White
90M-282	Dark Bronze

**.024 GAUGE**

Part #	Color
90M-287	White

**5/32" PLUNGER ASSEMBLIES**

Part #	Cap Color
90-635	White
90-635B	Black

**7/32" PLUNGER ASSEMBLIES**

Part #	Cap Color
90-635FT	White
90-635BFT	Black

Flip Type

**7/32" PLUNGER ASSEMBLIES**

Part #	Cap Color
900-9850	White
900-9850B	Black

**7/32" PLUNGER ASSEMBLIES**

Part #	Cap Color
900-9850FT	White
900-9850BFT	Black

Flip Type

**HAIR PIN CLIP**

**90-127**

**JIFFY HANGER**

**90-389**  
Mill

**FIXED PIN**

Part #	Description
900-21792	5/32"x1-1/8"
900-21747	7/32"x1-1/8"



## CUSTOM MADE WINDOW SCREENS

### SWIVEL CLIP

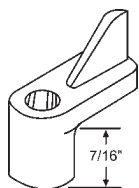

Part #	Color
90-380B	Black
90-380WH	White

### LOOP LATCH

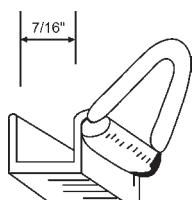

**900-9851**  
Slip-on Type

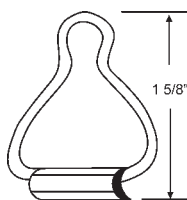

**90-103X**  
Spline Type

### BUTTERFLY LATCH

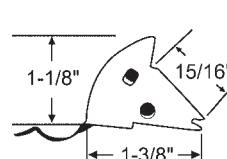

**90-506**

### CORNER SPRING

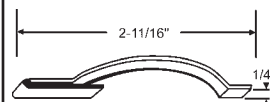

**90-498**

### TENSION SPRING

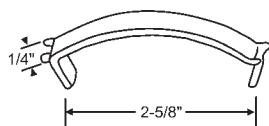

**16-158**

### PULL TABS

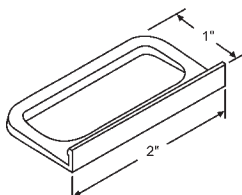

Part #	Color
900-12883	Clear
900-12883B	Black

Nylon - Lays Flat

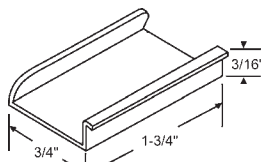

Part #	Color
90-118	Mill
90-118WH	White
90-118BZ	Bronze

Aluminum

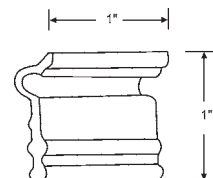

Part #	Description
90-633	Black rubber flexible
90-634	Black vinyl rigid
90-634G	Gray vinyl rigid

### .024 GAUGE

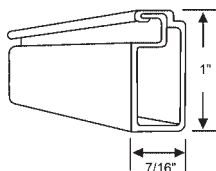

Part #	Color
90-504M	Mill
90-504W	White
90-504S	Stone
90-504BZ	Bronze

A Good Substitute to Fit Andersen Windows. When substituting for an Andersen screen, specify the external plastic corner keys.

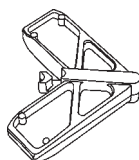

Part #	Color
90-503W	White
90-503BZ	Dk Bronze
90-503S	Stone

### 5/32" PLUNGER ASSEMBLIES

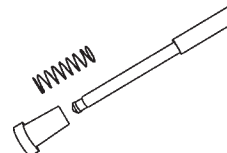

Part #	Cap Color
90-513	White
90-513B	Black

### FIXED PIN

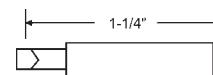

**90-698**  
5/32"x1-1/4"

### LOOP LATCH

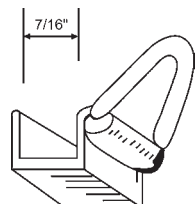

**900-9851**  
Slip-on Type

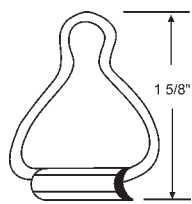

**90-103X**  
Spline Type

### SWIVEL CLIP

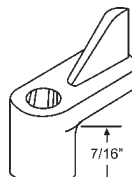

Part #	Color
90-380B	Black
90-380WH	White

### BUTTERFLY LATCH

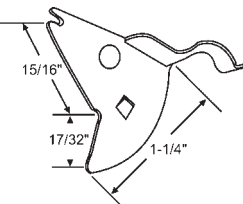

**90-515**

### JIFFY HANGER



**90-389**  
Mill

### CORNER SPRING

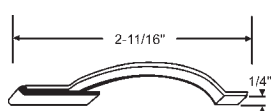

**90-498**

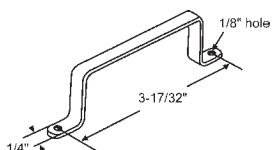

Part #	Color
90-390 (2816P)	Aluminum

### TENSION SPRING

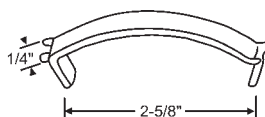

**16-158**

### PULL TABS

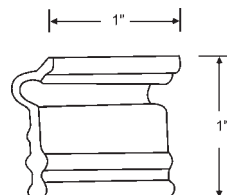

Part #	Description
90-633	Black rubber flexible
90-634	Black vinyl rigid
90-634G	Gray vinyl rigid

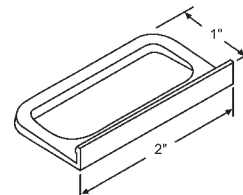

Part #	Color
900-12883	Clear
900-12883B	Black

Nylon - Lays Flat

# SCREEN HARDWARE

## CUSTOM MADE EXTRUDED ALUMINUM WINDOW SCREEN ORDER FORM

Account# \_\_\_\_\_

Page# \_\_\_\_ of \_\_\_\_

Sold To: \_\_\_\_\_

Ship To: \_\_\_\_\_

Salesman \_\_\_\_\_ Supervisor \_\_\_\_\_ Purchase Order# \_\_\_\_\_

Date \_\_\_\_\_ Quoted By \_\_\_\_\_ Customer # \_\_\_\_\_

### STEP 1 Measurement

\_\_\_\_\_ " Width x \_\_\_\_\_ " Height

Note: On all screen frames screen measurements must be box to box.

Note: Maximum screen size is 45" x 80". Can not process orders for any screens larger than 45" x 80".

### STEP 2 Identify Frame part #

Head Rail # \_\_\_\_\_

Right Rail # \_\_\_\_\_

Left Rail# \_\_\_\_\_

Sill Rail # \_\_\_\_\_

Note: No need to specify corner. Proper corner will be applied based on frame selected.

### STEP 3 Select frame finish.

White \_\_\_ Beige \_\_\_ Bronze \_\_\_ Brown \_\_\_  
Ivory \_\_\_ Almond \_\_\_

### STEP 7 Measure location of hardware and specify on drawing.

Always determine hardware location from the end of corner to either center or pivot point depending on type of hardware.

Fill out the positioning of the hardware below.

Location	Quantity	Number	Position - Number of inches from end (tip or corner)
Installed on HEAD RAIL			
Installed on SILL RAIL			
Installed on LEFT RAIL			
Installed on RIGHT RAIL			

### STEP 4 Select wire.

Charcoal Fiberglass (Standard) \_\_\_\_\_ Gray Fiberglass \_\_\_\_\_

Bright Aluminum \_\_\_\_\_ Charcoal Aluminum \_\_\_\_\_

Pet Screen \_\_\_\_\_ Other \_\_\_\_\_

### STEP 5 Crossbrace location

Required \_\_\_\_\_ Not Required \_\_\_\_\_

Horizontal: \_\_\_\_\_ inches up from the bottom

Vertical: \_\_\_\_\_ inches from the right rail

### STEP 6 Hardware: Required \_\_\_\_\_ Not Required \_\_\_\_\_

### STEP 7 Woolpile (if needed) specify height:

.250  .350  .600  .650

Specify Rail:  Head  Sill  Left  Right

Show Hardware Locations  
(Inside Looking Out / Spline on Outside)

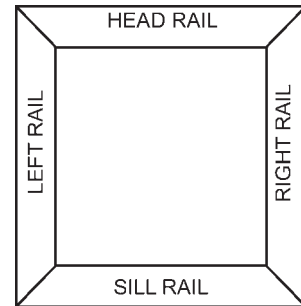

Part#	Quantity (see note below)	Size	Price Each	Amount
990E-999		" width <b>X</b> " height		
890-999-1		Window Screen Packaging Charge	\$ _____	
<b>Note: Minimum 2 screens per size &amp; color</b>			<b>TOTAL</b>	
			<b>FREIGHT</b>	

Note: On all screen frames screen measurements must be box to box.  
Note: Maximum screen size is 45" x 80". Can not process orders for any screens larger than 45" x 80".

### STEP 8 All Custom made window screen orders will not be processed without customer's signature verifying acceptance of our terms and conditions of order.

I understand that this material is not regular stock, but custom made to specifications as stated above. I understand and accept the condition that this material is NON-RETURNABLE and NON-CANCELABLE. A packaging charge of per screen will be assessed for quantities less than 10 of a size. IT IS THE RESPONSIBILITY OF THE CUSTOMER TO INSPECT FOR DAMAGE, AND MAKE THE CLAIM WITH THE CARRIER, AS WE ARE NOT RESPONSIBLE FOR DAMAGE.

Please Note: For all truck deliveries there is a minimum floor charge. There is an additional charge for residential deliveries.

Signature of Authorized Buyer \_\_\_\_\_ Buyer Phone \_\_\_\_\_ - \_\_\_\_\_

Title \_\_\_\_\_

## CUSTOM MADE EXTRUDED WINDOW SCREENS

Colors: White (W), Beige (BG), Bronze (BZ), Brown (BR), Ivory (IV) & Almond (AD).

NOTE: Check your specific frame for colors available. Colors not available for all frames.

### Group 1 - .050 GAUGE

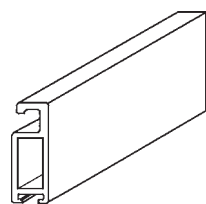

**90-1030**  
(5/16" x 3/4" Box) Plain  
Finishes: WH, BZ, BG, BR

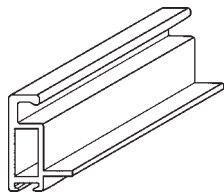

**90-1031**  
(5/16" x 3/4" Box) w/Stopleg  
Finishes: WH, BZ, BG, BR

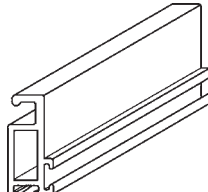

**90-1032**  
(5/16" x 3/4" Box) w/Woolpile  
Finishes: WH, BZ, BG, BR

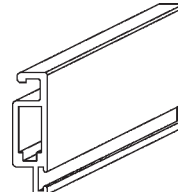

**90-1086**  
(5/16" x 3/4" Box) w/Woolpile  
Finishes: WH, BZ, BG, BR

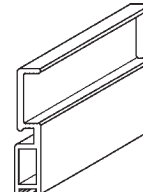

**90-1034**  
(5/16" x 3/4" Box) w/Lift Rail  
Finishes: WH, BZ, BG, BR

### Group 1A - .050 GAUGE

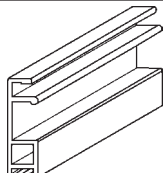

**90-1045** (.045 Gauge)  
(5/16" x 1") Plain  
Finishes: WH, AD

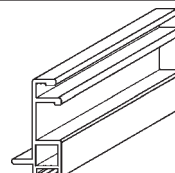

**90-1046** (.045 Gauge)  
(5/16" x 1") w/Stopleg  
Finishes: WH, AD

### Group 2 - .050 GAUGE

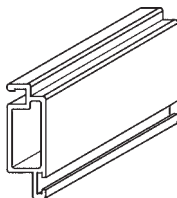

**90-1037**  
(3/8" x 7/8") w/Woolpile  
Finishes: WH, BG, BR, IV

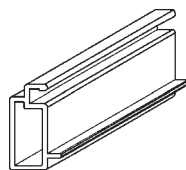

**90-1036**  
(3/8" x 7/8") w/Stopleg  
Finishes: WH, BG, BR, IV

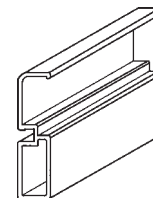

**90-1039**  
(3/8" x 7/8") w/Lift Rail  
Finishes: WH

### Group 3 - .050 GAUGE

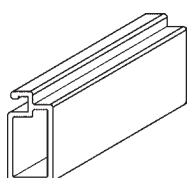

**90-1040**  
(7/16" x 7/8") Plain  
Finishes: WH, BG, BR

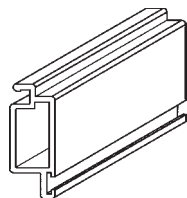

**90-1042**  
(7/16" x 7/8") w/Woolpile  
Finishes: WH, BG, BR

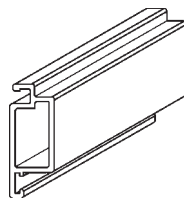

**90-1043**  
(7/16" x 7/8") w/Reverse Woolpile  
Finishes: WH, BG, BR

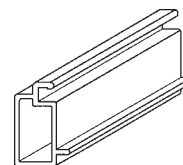

**90-1041**  
(7/16" x 7/8") w/Stopleg  
Finishes: WH, BG, BR

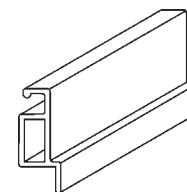

**90-1087** (.040 Gauge)  
(7/16" x 3/4" x 5/16") Offset  
Interior Flange w/Shoulder  
Finishes: WH, BZ

### Group 4 - .050 GAUGE

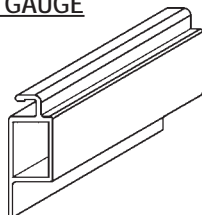

**90-1048**  
(3/8" x 3/4" Box x 5/16" Flange)  
For Exterior Application  
Finishes: WH, BZ, BG, BR, IV

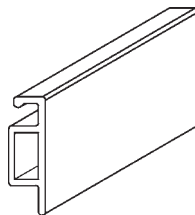

**90-1049**  
(5/16" x 3/4" Box x 5/16" Flange)  
For Interior Applications  
Finishes: WH

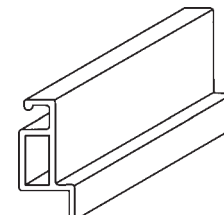

**90-1050**  
(5/16" x 3/4" Box x 5/16" Flange with Offset)  
For Interior Applications  
Finishes: WH

Need Lineals? - Call Today for Lineal Carton Quantities and Pricing. All Extruded Custom Window Screens use .150 Foam Spine (66-44 & 66-55)

# SCREEN HARDWARE

## EXTRUDED WINDOW SCREEN HARDWARE

### PLUNGER ASSEMBLIES

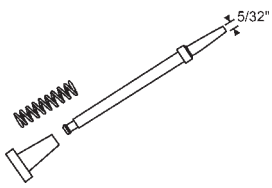

Part #	Cap Color
90-532	White
90-532B	Black

5/32" Blunt Tip. Metal Plunger

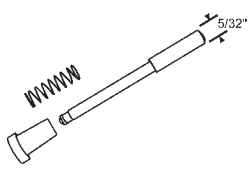

Part #	Cap Color
90-513	White
90-513B	Black

5/32" Metal Plunger.  
1-21/32" Long



**900-22575**  
5/32" Special Sharp  
Metal Plunger



Part #	Cap Color
90-1061	White
90-1061B	Black

5/32" Special Sharp Metal  
Plunger. Longer Reach

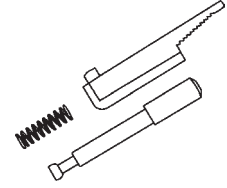

Part #	Cap Color
90-635FT	White

5/32" Flip Type. Metal Plunger

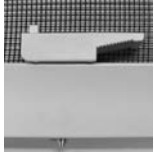

Part #	Hand	Cap Color
90-1059	Shown	White
90-1059LH	Opposite	White
90-1059B	Shown	Black
90-1059BLH	Opposite	Black

5/32" Flip Type, Tapered Point  
Metal Plunger



Part #	Cap Color
90-1060	White
90-1060B	Black

5/32" Tapered Point  
Metal Plunger



Part #	Cap Color
90-1062	White
90-1062B	Black

5/32" SNE #2 Metal Plunger

### WIRE LOOP LATCH

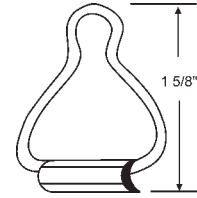

**90-103X**

### PULL TABS

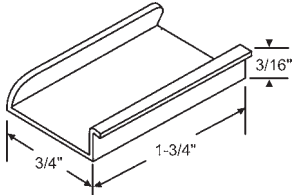

Part #	Finish
90-118	Aluminum
90-118WH	White
90-118BZ	Bronze

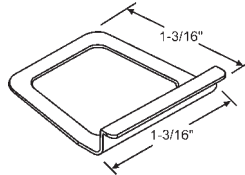

Part #	Finish
900-14950	Natural Nylon
900-14950W	White
900-14950B	Black

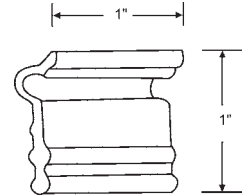

Part #	Finish
90-633	Black rubber flexible
90-634	Black vinyl rigid
90-634G	Gray vinyl rigid

### TENSION SPRINGS

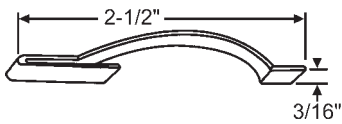

**900-17211**  
Mill

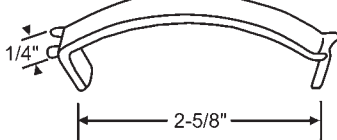

**16-158**

### POINTER LATCH

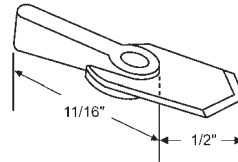

Part #	Finish
900-9823W	White
900-9823	Black

### LATCHES

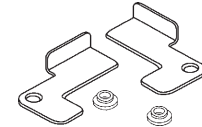

Part #	Hand	Finish
90-385	RH	Mill
90-384	LH	Mill

### WEATHERSTRIP

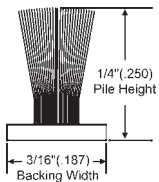

**63-507**  
Gray

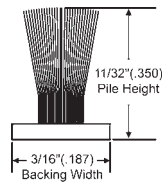

**63-508**  
Gray

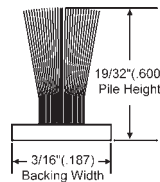

**63-509**  
Gray

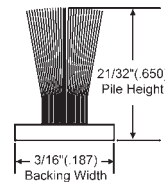

**63-510**  
Gray

## SCREEN FRAMES

.019 Gauge

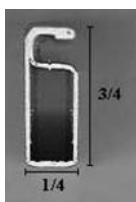

Part #	Length	Carton Qty	Wt	Color
90-250	12' 6"	180 lgths	113 lbs.	Mill
<b>90-250AD</b>	12' 6"	180 lgths	113 lbs.	Almond
90-251	12' 6"	180lgths	113 lbs.	White
90-252	12' 6"	180 lgths	113 lbs.	Bronze
90-253	8'	20 lgths	12 lbs.	Mill
90-254	8'	20 lgths	12 lbs.	White
90-255	8'	20 lgths	12 lbs.	Bronze

Screen frame uses .143-9/64" Spline. Note: All 8' Tubes are Packed with 20 Plastic External Corner Keys.

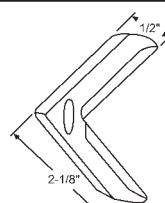

**90-352**

Inside Corner Key  
Metal

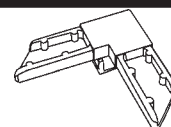

Part #	Color
90-451	Mill
<b>90-451AD</b>	Almond
90-452	White
90-453	Dark Bronze

Outside Corner Key  
Plastic

.019 Gauge



Part #	Length	Carton Qty	Wt	Color
90-232	12' 6"	180 lgths	109 lbs.	Mill
90-233	12' 6"	180 lgths	109 lbs.	White
90-234	12' 6"	180 lgths	109 lbs.	Bronze
90-235	8'	20 lgths	12 lbs.	Mill
90-236	8'	20 lgths	12 lbs.	White
90-237	8'	20 lgths	12 lbs.	Bronze

Screen frame uses .143-9/64" spline. Note: All 8' Tubes are Packed with 20 Plastic External Corner Keys.

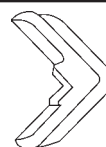

Part #	Color
90-347	Gray
90-348	White
90-349	Dark Bronze

Plastic External

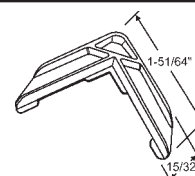

**90-346P**

Gray  
Plastic Internal

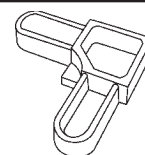

Part #	Color
<b>900-21783W</b>	White
<b>900-21783GY</b>	Gray

Outside Corner Key. Plastic  
**PHILIPS**

.019 Gauge



Part #	Length	Carton Qty	Wt	Color
90-220	12' 6"	160 lgths	100 lbs.	Mill
90-220AD	12' 6"	160 lgths	100 lbs.	Almond
90-221	12' 6"	160 lgths	100 lbs.	White
90-222	12' 6"	160 lgths	100 lbs.	Bronze
90-223	8'	20 lgths	12 lbs.	Mill
90-223AD	8'	20 lgths	12 lbs.	Almond
90-224	8'	20 lgths	12 lbs.	White
90-225	8'	20 lgths	12 lbs.	Bronze

Screen frame uses .143-9/64" spline. Note: All 8' Tubes are Packed with 20 Plastic External Corner Keys.



**90-106P**

Inside Corner Key  
Plastic

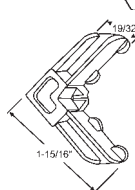

Part #	Color
90-436	Mill
<b>90-436AD</b>	Almond
90-437	White
90-438	Bronze

Outside Corner Key. Plastic

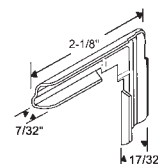

**90-106**

Inside Corner Key  
Metal



**90-437L**  
Pull Tab Outside  
Corner Key, White



**90-437LS**  
Pull Tab Outside Corner  
Key, w/ Stop, White

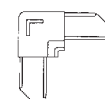

**90-437S**  
Outside Corner Key  
w/ Stop, White

.024 Gauge



Part #	Length	Carton Qty	Wt	Color
90-229	8'	20 lgths	12 lbs.	Mill
90-230	8'	20 lgths	12 lbs.	White
90-231	8'	20 lgths	12 lbs.	Bronze

Screen frame uses .143-9/64" spline. Note: All 8' Tubes are Packed with 20 Plastic External Corner Keys.

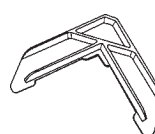

**90-106P**

Inside Corner Key  
Plastic

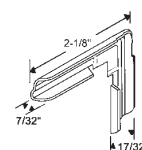

**90-106**

Inside Corner Key  
Metal

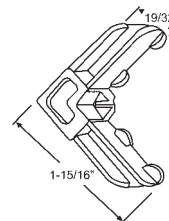

Part #	Color
90-436	Mill
<b>90-436AD</b>	Almond
90-437	White
90-438	Bronze

Outside Corner Key. Plastic

.019 Gauge

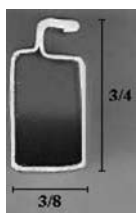

Part #	Length	Carton Qty	Wt	Color
90-196	12' 6"	130 lgths	86 lbs.	Mill
90-196AD	12' 6"	130 lgths	86 lbs.	Almond
90-197	12' 6"	130 lgths	86 lbs.	White
90-198	12' 6"	130 lgths	86 lbs.	Bronze
90-199	8'	20 lgths	12 lbs.	Mill
90-199AD	8'	20 lgths	12 lbs.	Almond
90-200	8'	20 lgths	12 lbs.	White
90-201	8'	20 lgths	12 lbs.	Bronze

Screen frame uses .143-9/64" spline. Note: All 8' Tubes are Packed with 20 Plastic External Corner Keys.

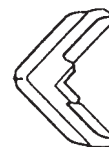

**90-125**

Inside Corner Key  
Metal

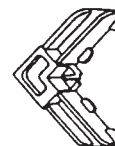

Part #	Color
90-454	Mill
90-454AD	Almond
90-455	White
90-456	Bronze

Outside Corner Key. Plastic

## SCREEN FRAMES

.019 Gauge

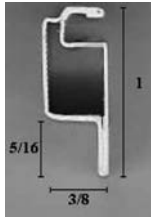

Part #	Length	Carton Qty	Wt	Color
90-997	12' 6"	120 lgths	98 lbs.	Mill
90-998	12' 6"	120 lgths	98 lbs.	Almond
90-999	12' 6"	120 lgths	98 lbs.	White
90-1000	8'	15 lgths	12 lbs.	Mill
90-1001	8'	15 lgths	12 lbs.	White
90-1002	8'	15 lgths	12 lbs.	Bronze

Screen frame uses .143-9/64" spline. Note: All 8' Tubes are Packed with 15 Plastic External Corner Keys.

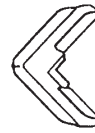

**90-125**  
Inside Corner Key  
Metal

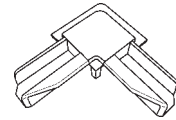

Part #	Color
90-1003	Mill
90-1004	White
90-1005	Bronze

Outside Corner Key. Plastic

.019 Gauge

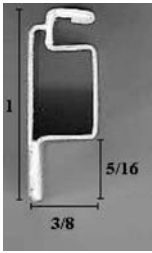

A Good Substitute For Bayform Series B38LI Frame

Part #	Length	Carton Qty	Wt	Color
90-1117	8'	15 lgths	12 lbs.	Mill
90-1118	8'	15 lgths	12 lbs.	White
90-1119	8'	15 lgths	12 lbs.	Bronze

Screen frame uses .143-9/64" spline. Note: All 8' Tubes are Packed with 15 Plastic External Corner Keys.



**90-125**  
Inside Corner Key  
Metal

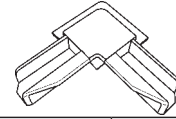

Part #	Color
90-1120	Mill
90-1121	White
90-1122	Bronze

Outside Corner Key. Plastic

.019 Gauge

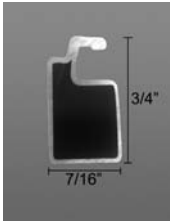

Part #	Length	Carton Qty	Wt	Color
90-280	12' 6"	120 lgths	90 lbs.	Mill
90-280AD	12' 6"	120 lgths	90 lbs.	Almond
90-281	12' 6"	120 lgths	90 lbs.	White
90-282	12' 6"	120 lgths	90 lbs.	Bronze
90-283	8'	20 lgths	12 lbs.	Mill
90-284	8'	20 lgths	12 lbs.	White
90-285	8'	20 lgths	12 lbs.	Bronze

Screen frame uses .220-7/32" spline. Note: All 8' Tubes are Packed with 20 Plastic External Corner Keys.



**90-463**  
Inside Corner Key  
Metal

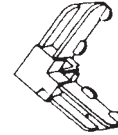

Part #	Color
90-460	Mill
90-460AD	Almond
90-461	White
90-462	Bronze

Outside Corner Key. Plastic

.024 Gauge

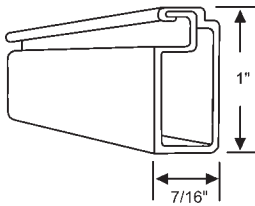

A Good Substitute to Fit Andersen Windows

When substituting for an Andersen screen, use the external plastic corner keys.

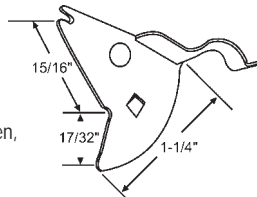

**90-515**  
Butterfly Latch

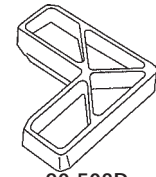

**90-503P**  
Internal Plastic Corner

Part #	Length	Carton Qty	Wt	Color
90-504M	12' 6"	84 lgths	100 lbs.	Mill
90-504AD	12' 6"	84 lgths	100 lbs.	Almond
90-504W	12' 6"	84 lgths	100 lbs.	White
90-504S	12' 6"	84 lgths	100 lbs.	Stone
90-504BZ	12' 6"	84 lgths	100 lbs.	Bronze
90-505M	8'	14 lgths	9 lbs.	Mill
90-505W	8'	14 lgths	9 lbs.	White
90-505BZ	8'	14 lgths	9 lbs.	Bronze

Screen frame uses .140-9/64" spline.

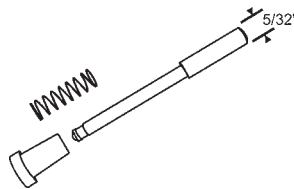

Part #	Cap Color
90-513	White Cap
90-513B	Black Cap

Plunger Pin. 5/32" Diameter Tip

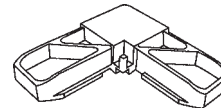

Part #	Color
90M-464	White
90M-464AD	Almond
90M-465	Dark Bronze

External Square Plastic Corner Key

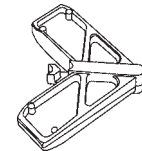

Part #	Color
90-503BZ	Bronze
90-503AD	Almond
90-503W	White
90-503S	Stone

External Plastic Corner Key

.019 Gauge



1/4" x 3/4"

Tubular Cross Brace

Part #	Length	Carton Qty	Wt	Color
90-178	11' 6"	230 lgths	118 lbs.	Mill
90-179	11' 6"	230 lgths	118 lbs.	White
90-180	11' 6"	230 lgths	118 lbs.	Bronze
90-181	8'	20 lgths	12 lbs.	Mill
90-182	8'	20 lgths	12 lbs.	White
90-183	8'	20 lgths	12 lbs.	Bronze

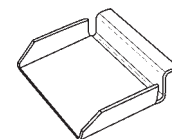

**90-313**  
Cross Brace Insert  
Fits 1/4" x 3/4" Cross Brace

## SCREEN WIRE & SCREEN CLOTH

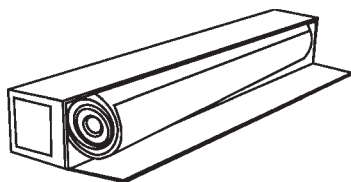

### Fiberglass 18 x 16 Mesh 100 Foot Roll

Popular package for contractors and for hardware stores that repair screens.

- 011" Diameter
- Easy to Install
- Resilient, Long Lasting
- Fire and Corrosion Resistant
- Will Not Crease, Dent or Unravel
- Withstands All Climates, Salt Air and Industrial Fumes

Width	Charcoal Part #	Gray Part #
16"	69-1	69-2
18"	69-7	69-8
20"	69-13	69-14
22"	69-19	69-20
24"	69-25	69-26
26"	69-31	69-32
28"	69-37	69-38
30"	69-43	69-44
32"	69-49	69-50
34"	69-55	69-56
36"	69-61	69-62
42"	69-67	69-68
48"	69-73	69-74
60"	69-79	69-80
72"	69-85	69-86

### Fiberglass 7' Roll

Popular item for home centers and hardware stores. A big do-it-yourself item. Enough to cover two average size windows or one screen door.

Width	Charcoal Part #
30"	69-43-7
36"	69-61-7
48"	69-73-7

### Fiberglass 18 x 16 Mesh 600 Foot Roll (Other Sizes Available)

Width	Charcoal Part #	Gray Part #
16"	69-3	69-4
18"	69-9	69-10
20"	69-15	69-16
22"	69-21	69-22
24"	69-27	69-28
26"	69-33	69-34
28"	69-39	69-40
30"	69-45	69-46
32"	69-51	69-52
34"	69-57	69-58
36"	69-63	69-64
42"	69-69	69-70
48"	69-75	69-76
60"	69-81	69-82
72"	69-87	69-88

### Aluminum 18 x 16 Mesh 100 Foot Roll

Popular package for contractors and for hardware stores that repair screens.

- 011" Diameter
- Strong and Durable
- Resists Rust, Won't Sag
- Withstands all Climates
- Protective Finish Prevents Corrosion, Strengthens Weave, Enhances Appearance

Width	Bright Part #	Charcoal Part #	Black Part #
16"	69-5	69-6	69-6B
18"	69-11	69-12	69-12B
20"	69-17	69-18	69-18B
22"	69-23	69-24	69-24B
24"	69-29	69-30	69-30B
26"	69-35	69-36	69-36B
28"	69-41	69-42	69-42B
30"	69-47	69-48	69-48B
32"	69-53	69-54	69-54B
34"	69-59	69-60	69-60B
36"	69-65	69-66	69-66B
42"	69-71	69-72	69-72B
48"	69-77	69-78	69-78B
60"	69-83	69-84	69-84B
72"	69-89	69-90	69-90B

## Solar Screen Cloth



Solar Screening is an inexpensive and easy to install alternative designed to provide an attractive outdoor appearance while maintaining good visibility from inside with no distortion. It filters sunlight, helps reduce air conditioning bills and lessens fading of carpet, upholstery and drapes. Superior heat resistance and color retention help keep it looking great for years.

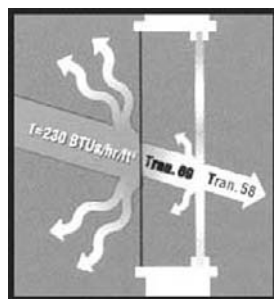

Energy-saving sun screening provides maximum solar control and visibility.

### Sun Guard 85

(54 x 18 mesh .011" Diameter)

Reflects and dissipates up to 75% of sun's rays entering the building.

Part #	Size	Color
69-S25	24" x 100'	Charcoal
69-S43	30" x 100'	Charcoal
69-S61	36" x 100'	Charcoal
69-S73	48" x 100'	Charcoal
69-S79	60" x 100'	Charcoal
69-S85	72" x 100'	Charcoal

### Sun Guard 90

(40 x 40 mesh .011/0.13" Diameter)

Reflects and dissipates up to 90% of sun's rays entering the building.

Part #	Size	Color
69-187	36" x 100'	Charcoal
69-188	48" x 100'	Charcoal
69-189	60" x 100'	Charcoal
69-190	72" x 100'	Charcoal
69-191	96" x 100'	Charcoal

# TEXTILENE PetTex

### Charcoal PET SCREEN Cloth 100' Rolls

(17 x 11 mesh .025" Diameter)

Part #	Size
69-PP61	36" x 100'
69-PP73	48" x 100'
69-PP79	60" x 100'

Resistant to tears and damage caused by household pets.

Textilene® PetTex is designed using extruded vinyl-coated polyester core yarn, which is resistant to tears and damage caused by household pets. Textilene® PetTex Screen is heavier than the traditional fiberglass and aluminum screenings and is pet paw resistant. Textilene® PetTex will in fact withstand tough use even in the most extreme conditions.

Install this product into window screens, sliding screen doors, porch screens or anywhere traditional screening is used. Textilene® PetTex is resistant to tears and damage caused by household pets.

#### INSTALLATION:

Easily installed, just as standard window screen mesh is installed in doors or windows.

#### STRENGTH:

Textilene® PetTex is made from vinyl coated polyester. It is much heavier than traditional fiberglass or aluminum screening. Pet Screen is 7 times stronger than traditional screen mesh.



Ultra strong screening resists tears and damage by dogs and cats yet still offers superb outward visibility. Ideal for areas where children or pets push against the screen.

### Pet Screen Cloth

(17 x 11 Mesh .025" Diameter)

Width	Charcoal Part #
36" x 100'	69-PP61-DS
36" x 7'	69-PP61-7
48" x 100'	69-PP73-DS
48" x 7'	69-PP73-7

Resistant to tears and damage caused by household pets.

Only Available for Drop Ship Orders



# SuperScreen™

The Newest Technology in Enclosure Screen!

The Newest Technology Available in Screen Protection for Pool, Porch and Patio Enclosures, SuperScreen™ is the Perfect Choice for Those Who Demand the Very Best in Safety, High Quality and Long Lasting Home Improvement Products.

- SuperScreen™ is so durable it has a **10 YEAR LIMITED WARRANTY** and is guaranteed to last.
- SuperScreen™ exceeds Florida's building code requirements of section 553.73 for pool fencing.
- SuperScreen™ is lightweight yet **pet resistant** and is tear and puncture proof.
- SuperScreen™ is a PVC coated polyester fabric that **defy's deterioration**.
- SuperScreen™ is compounded with a **biocide** that **resists bacteria**, fungus and mildew growth. This means that it will retain it's color, longevity and filtering characteristics
- SuperScreen™ is Available in Two Mesh Sizes
  1. The 17 x 14 mesh is the standard size for screens. It blocks out 30% of harmful UV rays of the sun.
  2. The 17 x 20 mesh blocks out 50% of the harmful UV rays of the sun.
- The fine smaller mesh size is superior in **protecting** against mosquitoes and small insects.
- SuperScreen™ is .022 gauge, has the **flexibility** of fiberglass screen fabric, yet the **durability** of the thickest pet screens on the market.
- SuperScreen™ is being used on homes adjacent to golf courses to **protect** from errant golf balls.

### SuperScreen™ Comes in Two Mesh Sizes

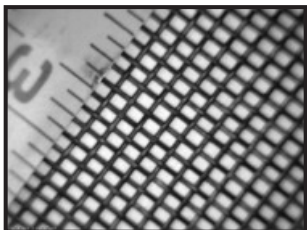

Black 17 x 14 Mesh	
Size 100' Roll	Part #
36"	69-151
48"	69-152
60"	69-153
72"	69-154
84"	69-156
96"	69-157
108"	69-159
120"	69-160

The 17 x 14 mesh size offers the clearest viewing when sitting on a porch or balcony and looking out at the landscape, while still protecting you from flies, mosquitoes and other small insects. The 17 x 14 mesh blocks out 30% of the harmful UV rays and lets the good rays in that lets your plants flourish.

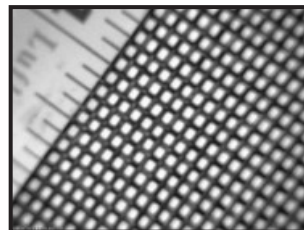

The 17 x 20 mesh is a little smaller so it keeps out some of the smaller insects. Yet, it allows you to view your landscape with little to no distortion. The 17 x 20 mesh blocks out 50% of the harmful UV rays and still lets in the good rays to help your plants grow.

Black 17 x 20 Mesh	
Size 100' Roll	Part #
36"	69-162
48"	69-163
60"	69-164
72"	69-165
84"	69-167
96"	69-168
108"	69-170
120"	69-171



## SCREEN WIRE & SCREEN CLOTH



Charcoal

### Pool, Porch & Patio Fiberglass Screen Cloth

(18 x 14 Mesh .013" Diameter)

Pool, Porch & Patio Screening is for use in pool, patio and sun room enclosures. It offers superior strength and durability.

Width	Charcoal Part #
36" x 100'	69-P61
48" x 100'	69-P73
60" x 100'	69-P79
72" x 100'	69-P85
84" x 100'	69-P92
96" x 100'	69-P96
108" x 100'	69-P108



Charcoal

### Viper - Vision perfect

(18 x 18 mesh .009" diameter)

Viper Screen provides better visibility than our standard fiberglass screen by using an enhanced tighter weave and finer mesh woven from smaller refined yarns. Viper not only offers a maximized view, but also provides better airflow and more light.

Features and benefits of Viper include:

- 20% thinner yarn for enhanced visibility, greater light transmission and airflow
- Smaller opening than the standard screen provides better insect protection
- Smaller yarns increases appearance of screen and curb appeal

Part #	Size
69-V7	18" x 100'
69-V25	24" x 100'
69-V37	28" x 100'
69-V43	30" x 100'
69-V49	32" x 100'
69-V55	34" x 100'
69-V61	36" x 100'
69-V73	48" x 100'
69-V79	60" x 100'
69-V85	72" x 100'



Charcoal

### No-See-Um Fiberglass Screen Cloth

(20 x 20 Mesh .013" Diameter)

Finer mesh screening to protect against no-sees-ums, gnats, sand flies, and other tiny, irritating insects common in low marshy areas.

Width	Charcoal Part #
36" x 100'	69-61NSM
48" x 100'	69-73NSM
60" x 100'	69-79NSM

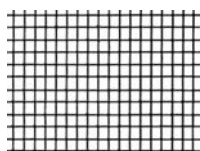

Bronze

### Bronze Screening

(18 x 14 Mesh .011" Diameter)

Our heavy-duty solid bronze insect screening is designed for fabrication of high quality window screens and screen doors. It is woven of .011" solid bronze wire into an 18 X 14 mesh.

Width	Bright Bronze Part #
24" x 100'	69-29BR
30" x 100'	69-47BR
36" x 100'	69-65BR
48" x 100'	69-77BR

## SCREEN SPLINE

### Gray & Black Vinyl Hollow Ribbed Spline

Replacement spline for metal and fiberglass screening available in 100 ft., 250 ft., 500 ft. and 1,000 ft. spools.



Sold by Spools

### 250 Foot Spools

Part # Gray	Part # Black	Trade Size	Decimal Size
66-2	66-2B	1/8"	.120
66-6	66-6B	9/64"	.140
66-10	66-10B	11/64"	.165
66-14	66-14B	3/16"	.187
66-104	66-104B	7/32"	.220
66-18	66-18B	15/64"	.230
66-22	66-22B	1/4"	.250



1/8" (.120)



9/64" (.140)



11/64" (.165)



3/16" (.187)



15/64" (.230)



1/4" (.250)

# SCREEN HARDWARE

## SCREEN SPLINE

### Gray & Black Vinyl Hollow **Ribbed** Spline (Continued)

#### 500 Foot Spools

Part # Gray	Part # Black	Trade Size	Decimal Size
66-3	66-3B	1/8"	.120
66-7	66-7B	9/64"	.140
66-11	66-11B	11/64"	.165
66-15	66-15B	3/16"	.187
66-19	66-19B	15/64"	.230
66-23	66-23B	1/4"	.250

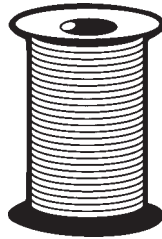

Sold by Spools

#### 1000 Foot Spools

Part # Gray	Part # Black	Trade Size	Decimal Size
66-4	66-4B	1/8"	.120
66-8	66-8B	9/64"	.140
66-12	66-12B	11/64"	.165
66-16	66-16B	3/16"	.187
66-20	66-20B	15/64"	.230



1/8" (.120)



9/64" (.140)



11/64" (.165)



3/16" (.187)



15/64" (.230)



1/4" (.250)

### Gray & Black Vinyl Hollow **Round** Spline

Replacement spline for metal and fiberglass screening. Available in 200 ft., 750 ft., and 1,000 ft. spools.

#### 200 Foot Spools

Part # Gray	Part # Black	Trade Size	Decimal Size
66-64	66-65	1/8"	.125
66-68	66-69	9/64"	.140
66-72	66-73	5/32"	.156
-	66-77	11/64"	.172
66-80	66-81	13/64"	.203
66-27	66-27B	7/32"	.220

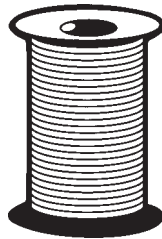

Sold by Spools

#### 1000 Foot Spools

Part # Gray	Part # Black	Trade Size	Decimal Size
66-62	66-63	1/8"	.125
66-66	66-67	9/64"	.140
66-70	66-71	5/32"	.156
-	66-75	11/64"	.172
-	66-79	13/64"	.203



1/8" (.125)



9/64" (.140)



5/32" (.156)



11/64" (.172)



13/64" (.203)



15/64" (.234)



1/4" (.250)

### Solid Black **Foam** Spline

Replacement spline for metal and fiberglass screening. Available in 500 ft., 1,000 ft., 1,500 ft. and 3,000 ft. spools.

#### 500 Foot Spools

Part # Black	Decimal Size
66-40	.135
66-42	.140
66-44	.150
66-46	.155
66-48	.170
66-50	.235
66-52	.250

#### 1000 Foot Spools

Part # Black	Decimal Size
66-41	.135
66-43	.140
66-45	.150
66-47	.155
66-49	.170
66-51	.235
66-53	.250
66-60M	.270

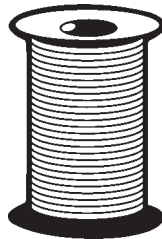

Sold by Spools

- Solid Black Foam Spline produced with only 100% virgin materials.
- User friendly -helps reduce operator fatigue.
- The softness of solid black foam spline allows it to be easily inserted in channels and allows easy cornering.
- Helps reduce customers' inventory. One size will work for several different screen channels.

#### 1500 Foot Spools

Part # Black	Decimal Size
66-57	.235
66-34	.250

#### 3000 Foot Spools

Part # Black	Decimal Size
66-54	.135
66-30	.140
66-55	.150
66-56	.155
66-31*	.170

(\* 2700 Foot spools only)



.135



.140



.150



.155



.170



.235



.250



.270

## SCREEN DOOR SPLINE

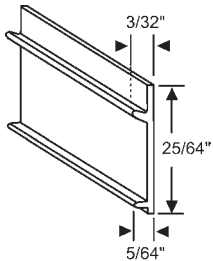

### 66-61X

Vinyl Screen Spline. Black  
Sold in 100' Rolls  
**FOREVER DOOR**

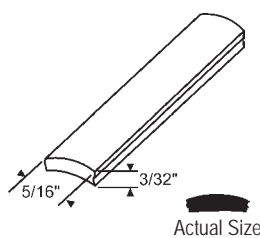

Actual Size

Part #	Length
16-240B	100 ft. Roll
16-240BM	1000 ft. Roll

Flat Spline. Black

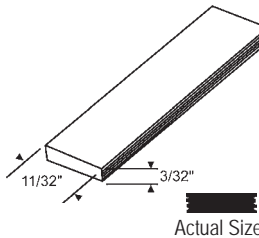

Actual Size

Part #	Length
16-239	100 ft. Roll
16-239X	750 ft. Roll

Flat Spline. Black  
**PEACHTREE**

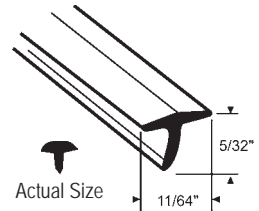

Actual Size

Part #	Length
16-241	100 ft. Roll
16-241M	1000 ft. Roll

Black Spline made of polyethylene.  
Used with fiberglass cloth for patio  
screen doors.

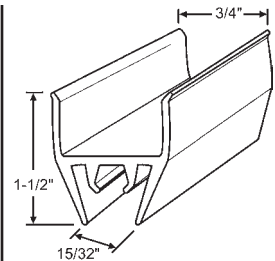

### 16-437-96

Black Vinyl  
96" Lengths.  
Minimum order 5" Lengths

## TENSION SPRINGS

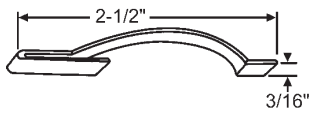

Part #	Description
900-17211	Steel
900-17211SS	Stainless Steel

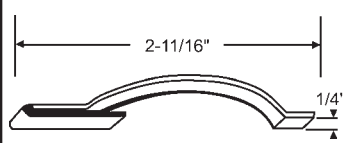

**90-498**

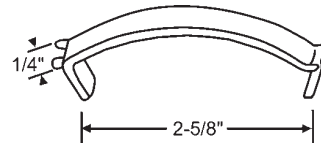

**16-158**

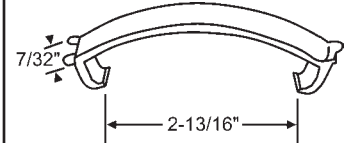

**900-17011**

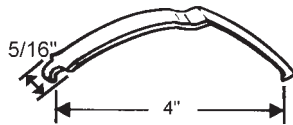

**90-98**



**900-12221**  
Ram Horn Spring

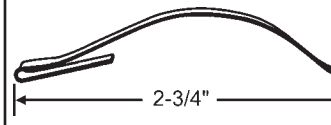

**900-18037**  
3/16" Wide

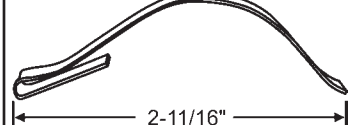

**90-628**  
1/4" Wide

## WIRE LOOP LATCHES

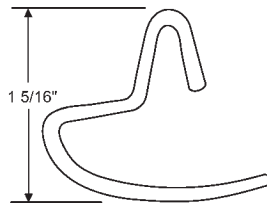

**90-127**

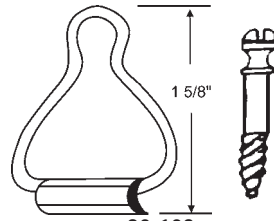

**90-103**  
Wire Loop Latch Set  
90-103X Loop Only  
20-019 Screw Only

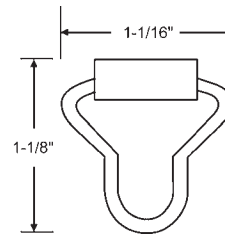

**90-104**  
Small Loop Latch. Used with Ball Head Screw 20-019

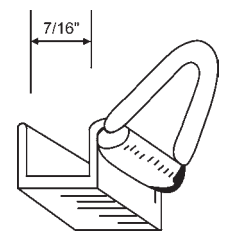

**900-9851**  
Slip-On Type  
Aluminum Finish

## ALUMINUM STRETCH CLIPS

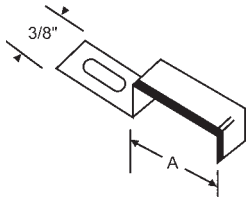

Part #	"A"	"B"	Part #	"A"	"B"
90-1096	5/8"	1/8"	90-61	11/16"	3/8"
90-60	5/8"	1/4"	90-71	3/4"	9/32"
90-68	5/8"	5/16"	90-58	3/4"	5/16"
90-65	11/16"	1/4"	90-58BZ	3/4"	5/16"
WSC149	11/16"	3/16"	90-58W	3/4"	5/16"
WSC 8	11/16"	5/16"	90-59	3/4"	3/8"
90-1095	11/16"	5/16"	90-62	13/16"	9/32"
90-1097	11/16"	17/64"	90-55	7/8"	5/16"
90-72	11/16"	9/32"			

Aluminum

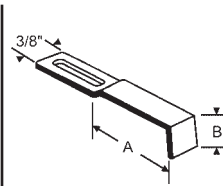

Part #	"A"	"B"
90-67	11/16"	11/32"
90-64	7/8"	5/16"

Aluminum

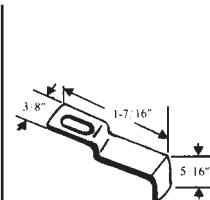

**90-69**  
Aluminum

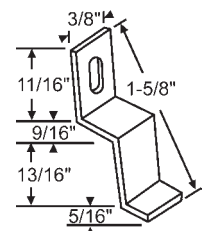

**90-1068**  
Aluminum

## CEE CLIPS

## ZEE CLIPS

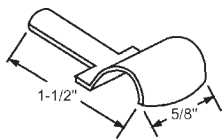

**90-850**  
OLD MIAMI

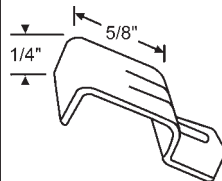

**33-101N**  
Jalousie Screen Clip  
KELLER

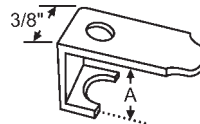

Part #	"A"
90-30	3/16"
90-31	1/4"
90-32	3/8"
90-33	7/16"
90-34	5/16"

Aluminum

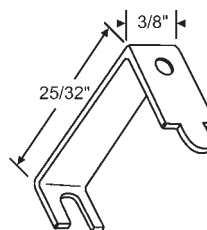

**90-27SS**  
Stainless Steel

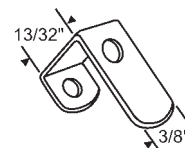

**90-1098**

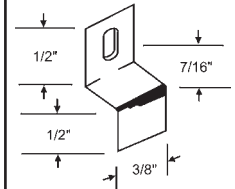

Part #	Description
90-52	Stainless Steel

# SCREEN HARDWARE

## ZEE CLIPS

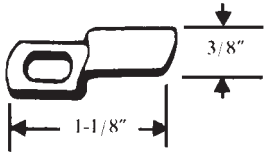

Part #	Offset
90-1009	1/8"
90-47	3/16"
90-49	5/16"
90-50	3/8"

Aluminum

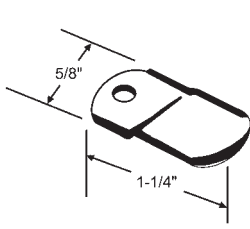

**90-46**  
1/16" Offset  
Aluminum

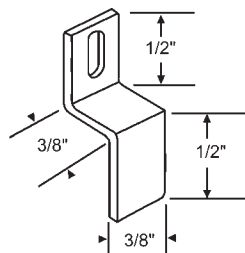

**90-724**  
Stainless Steel

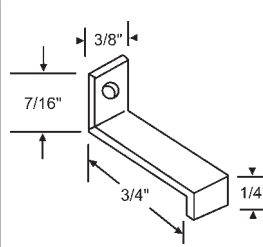

**90-44**  
Aluminum

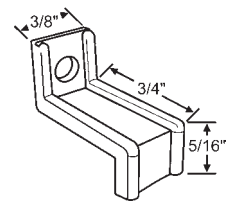

Part #	Color
90-907B	Black
90-907W	White

**SECURITY**

## DIMPLE CLIPS

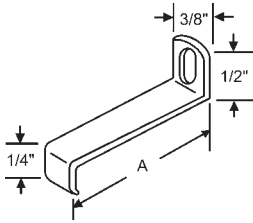

Part #	"A"
90-40	1"
90-41	1-1/8"
90-42	1-1/2"
90-43	1-5/8"
900-7017*	1-3/4"

Aluminum

\*Large minimum required

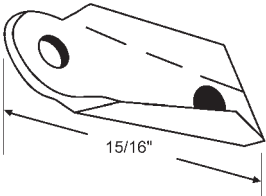

Part #	Hole Size	Dimple Size
90-73	3/16"	Small
90-80	5/32"	Small

Aluminum

## WING CLIP

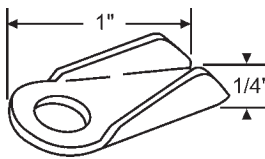

**90-1094**  
9/32" Dia. Hole.  
Aluminum

## FLAT NYLON WING CLIPS

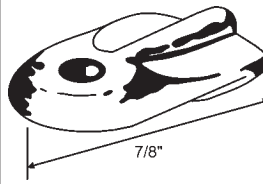

Part #	Color
90-77	White
90-77B	Black
90-77A	Almond
90-77C	Clear

Nylon - 1/8" Hole

## CLIP

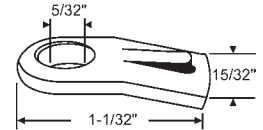

Part #	Color
90-552	Clear
90-552W	White

3/32" Offset

## PLASTIC SWIVEL CLIPS

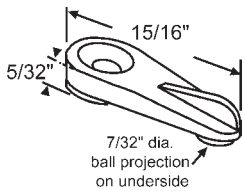

Part #	Color
900-1497	Natural

Screen Clip Flush

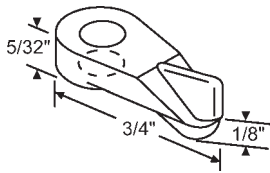

Part #	Color
900-1426	White
900-1426B	Black

5/32" Hole  
**SEASONALL**

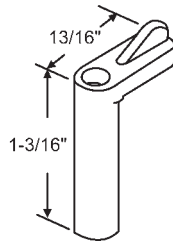

Part #	Color
90-727WX	White
90-727BX	Black

Casement Clip.  
Uses Part #20-427 Screw.

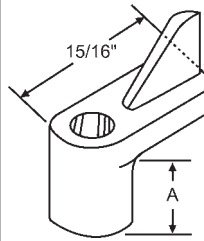

Part #	"A"	Hole Size	Color
90-834	Flush	3/16"	Natural
90-78	1/16"	3/16"	Natural
90-78B	1/16"	3/16"	Black
900-1457	1/16"	3/16"	Clear
90-381	3/16"	3/16"	White
90-381NAT	3/16"	3/16"	Natural
90-381GY	3/16"	3/16"	Grey
90-837	1/4"	3/16"	Natural
90-332	5/16"	3/16"	White
90-332BR	5/16"	3/16"	Brown
90-379	3/8"	3/16"	Natural
90-379BR	3/8"	3/16"	Brown
90-379G	3/8"	3/16"	Gray
90-380	7/16"	3/16"	Natural
90-380WH	7/16"	3/16"	White

## DIE CAST CLIPS

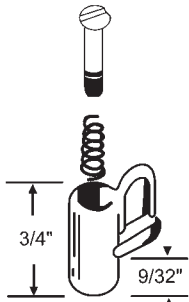

**90-101P**  
Clip Assembly. Natural

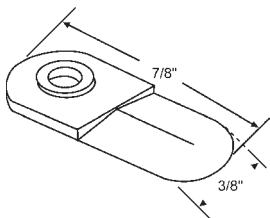

**900-7113**  
1/32" Offset

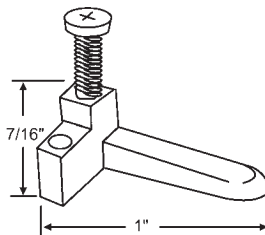

**90-99**  
Washer & Screw Included

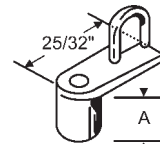

Part #	"A"	Hole Size
90-158	Flush	3/16"
90-81	3/16"	3/16"
90-82	1/4"	3/16"
90-83	5/16"	3/16"
90-84	3/8"	3/16"
90-85	7/16"	3/16"

## SCREEN CLIPS

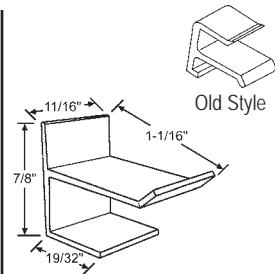

**900-5687**  
Top Screen Clip, Black  
**BELKNAP**

## SCREEN CLIPS

**90-5688**  
Bottom Screen Clip, Black

## RETAINER CLIP

**90-839**  
White Nylon  
Screen Spring Retainer Clip  
**PATRIOT**

## PIVOT POST

**900-9351**  
**ACORN**

## HANGER

**900-7098**  
Female Hanger  
**JIM WALTERS**

## POINTER LATCH

Part #	Color
90-124	White
90-124B	Black

## LATCHES

Part #	Color
900-9823	Black
900-9823W	White
900-9823N	Natural

**90-384A**  
Screen Latch Set  
LH Only: 90-384. RH Only: 90-385  
Bushing Only: 900-7231

Part #	Color
750-0873293	Stone
750-0873292	White

Screen Latch Set

**900-21432**  
Clear Plastic  
**PEACHTREE**

Part #	Hand
90-383	Shown
90-382	Opposite

Knife Latch. Mill

**750-2962208**  
Pair

**750-2962214**  
Pair

**750-2962218**  
Pair

**750-2962202**  
Pair. Stone Finish

**750-2962216**  
Pair

**90-506**  
Pair

**90-883A**  
Sold in Sets Only (LH Shown)

**90-515**  
Pair (LH/RH)  
Stainless Steel

Part #	Color	Screw
900-9352	White	No
900-9352B	Black	No
900-9352A	White	Yes
900-9352BA	Black	Yes

Nylon Screen Latch  
**ACORN**

**900-18585**  
Vinyl Screen Latch  
**MALTA**

## SLIDE LATCHES

**90-90**  
Aluminum

**90-91**  
Aluminum

Part #	Color
90-715	Bronze
90-715W	White
90-715M	Mill

## FIXED PINS

**90-698**  
5/32"x1-1/4"  
Aluminum

Part #	Description
900-21792	5/32" Plunger
900-21747	7/32" Plunger

# SCREEN HARDWARE

## CROSS BRACE INSERT

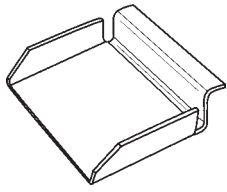

**90-313**

Fits 1/4" x 3/4" Cross Brace

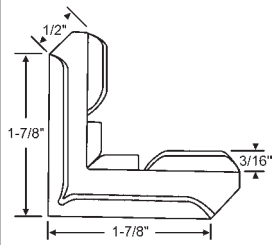

Part #	Color
90-125	Mill
90-125B	Black

Metal

## SCREEN CORNERS

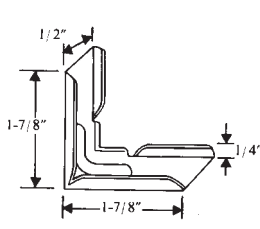

**90-106**

Metal

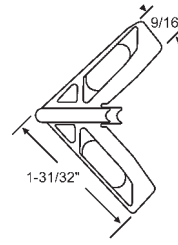

Part #	Color
90-865TN	Tan
90-865	White
90-865BZ	Bronze

Plastic

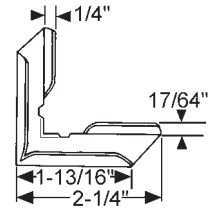

**90-487**

Metal

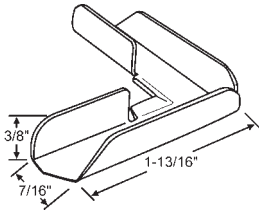

**90-350**

Beige. Aluminum

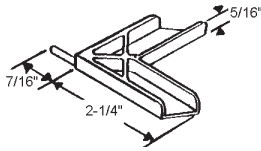

**900-13515**

Black

**ACORN**

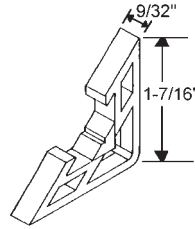

**900-10679B**

Black

**SEASONALL**

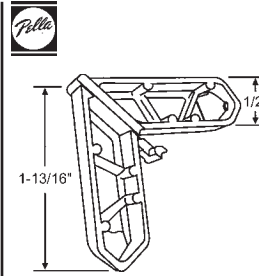

**900-16634**

Champagne

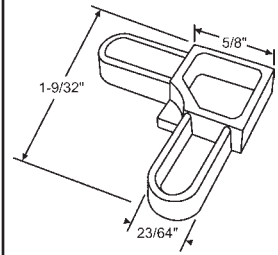

Part #	Color
900-21783W	White
900-21783GY	Gray

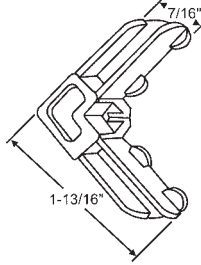

Part #	Color
90-347	Gray
90-348	White
90-349	Dark Bronze

Plastic

**FLORIDA SCREEN**

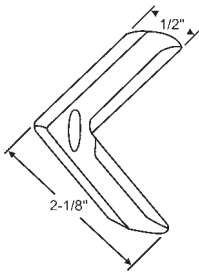

**90-352**

Metal

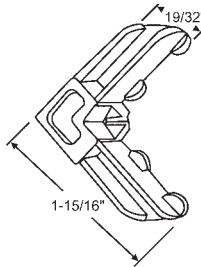

Part #	Color
90-436	Gray
90-437	White
90-438	Dark Bronze

Plastic

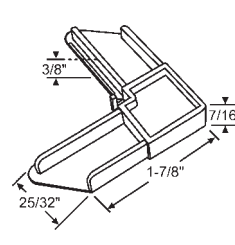

Part #	Color
900-19936	Beige
900-19936WH	White

Plastic. Fits Kolbe

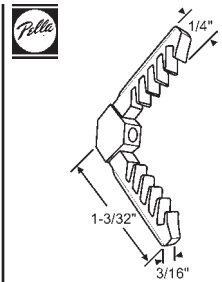

**90-931W**

White

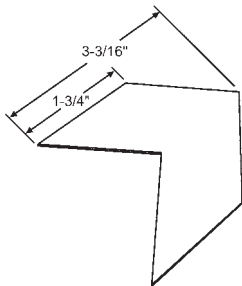

**90-1080**

1/16" Thick

**TRACO**

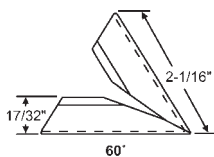

**90-978**

60° Aluminum Corner for 3/8" x 3/4" Screen Frame

**BAYFORM**

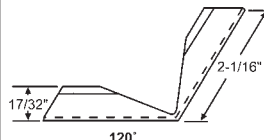

**90-979**

120° Aluminum Corner for 3/8" x 3/4" Screen Frame

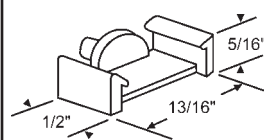

**900-1451C**

Clear

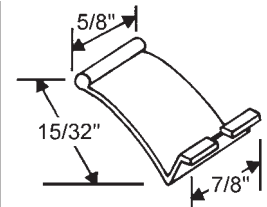

Part #	Color
90-116	Natural
90-116B	Black

Vinyl

## GRILLE FASTENER

## LIFTS & PULL TABS

Lifts Packaged 25 Per Bag

## LIFTS & PULL TABS

Lifts Packaged 25 Per Bag

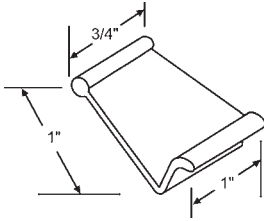

Part #	Color
90-117	Natural
90-117B	Black

Nylon

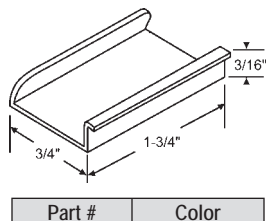

Part #	Color
90-118	Mill
90-118WH	White
90-118BZ	Bronze

Aluminum

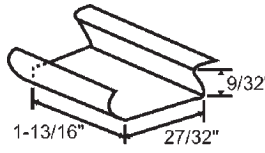

Part #	Color
90-378	Mill

Aluminum

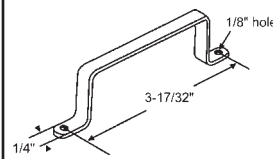

**90-390**

Flat Aluminum Handle, Mill

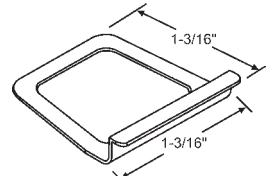

Part #	Color
900-14950	Natural
900-14950B	Black
900-14950W	White

Nylon

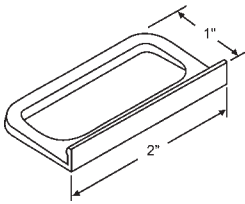

Part #	Color
900-12883	Natural
900-12883B	Black

Nylon

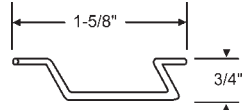

**90-377**  
Wire Lift



**750-1631110**  
Screen Finger Pull

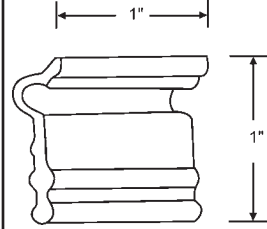

Part #	Color
90-633	Black rubber flexible
90-634	Black vinyl rigid
90-634G	Gray vinyl rigid

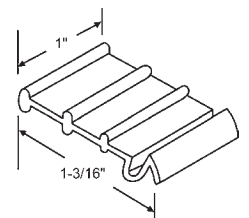

**90-129**  
Plastic, Black

## SPRING PLUNGERS

In Order by Tip Outside Diameter

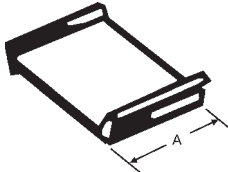

Part #	Color	"A"
90-785	White	3/4"
90-376	Black	1"
90-376GY	Gray	1"

Vinyl

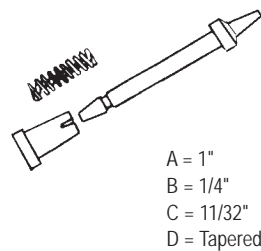
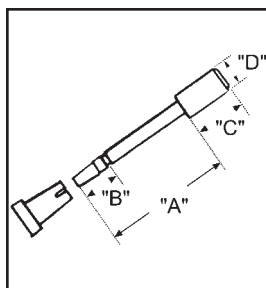

A = 1"  
B = 1/4"  
C = 11/32"  
D = Tapered

**90-15**  
Snap-On Plastic Knob, White

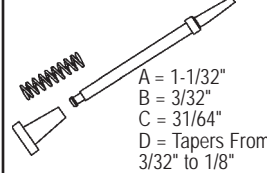

A = 1-1/32"  
B = 3/32"  
C = 31/64"  
D = Tapers From 3/32" to 1/8"

Part #	Knob
90-532	White
90-532B	Black

Blunt Tip Plunger Assembly  
Plastic Knob, Black

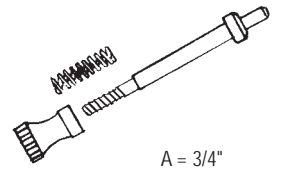

A = 3/4"  
B = Threaded  
C = 5/16"  
D = 1/8"

**90-22**  
Metal Screw-On Knob

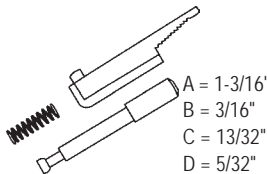

A = 1-3/16"  
B = 3/16"  
C = 13/32"  
D = 5/32"

Part #	Knob	Hand
90-635FT	White	RH
90-635FTL	White	LH

Flip Type

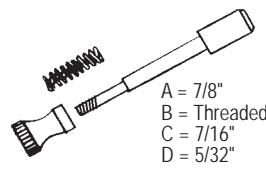

A = 7/8"  
B = Threaded  
C = 7/16"  
D = 5/32"

**90-21**  
Screw-On Metal Knob  
Metal Plunger

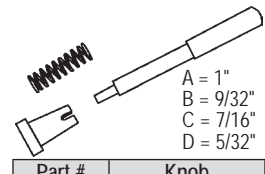

A = 1"  
B = 9/32"  
C = 7/16"  
D = 5/32"

Part #	Knob
90-136	White
90-136B	Black

Snap-On Plastic Knob,  
Metal Plunger

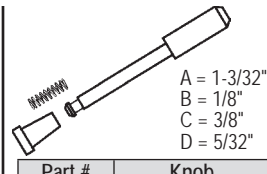

A = 1-3/32"  
B = 1/8"  
C = 3/8"  
D = 5/32"

Part #	Knob
90-635	White
90-635B	Black

Metal Plunger

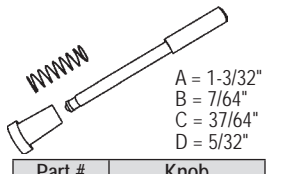

A = 1-3/32"  
B = 7/64"  
C = 37/64"  
D = 5/32"

Part #	Knob
90-513	White
90-513B	Black

For Use with 1" Frame

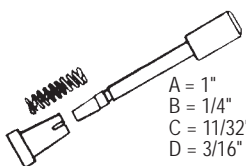

A = 1"  
B = 1/4"  
C = 11/32"  
D = 3/16"

**90-23**  
Snap-On Knob, White Plastic  
Metal Plunger

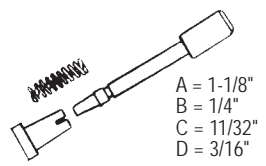

A = 1-1/8"  
B = 1/4"  
C = 11/32"  
D = 3/16"

**90-20**  
Snap-On Knob, White Plastic  
Metal Plunger

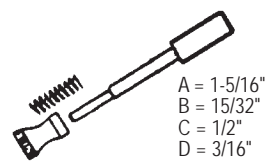

A = 1-5/16"  
B = 15/32"  
C = 1/2"  
D = 3/16"

**900-7070**  
Stake-On Knob  
Metal Knob and Plunger

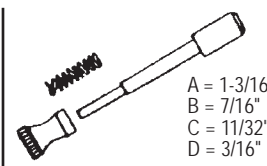

A = 1-3/16"  
B = 7/16"  
C = 11/32"  
D = 3/16"

**90-322**  
Stake-On Knob  
Metal Knob and Plunger

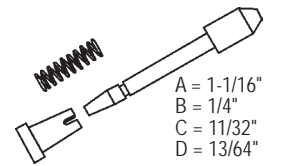

A = 1-1/16"  
B = 1/4"  
C = 11/32"  
D = 13/64"

**90-12**  
Snap-On Knob, White  
Plastic

# SCREEN HARDWARE

## SPRING PLUNGERS

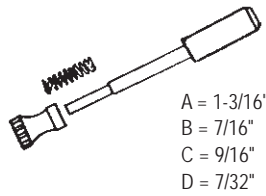

A = 1-3/16"  
B = 7/16"  
C = 9/16"  
D = 7/32"

**90-327**  
Stake-On Knob  
Metal Knob and Plunger

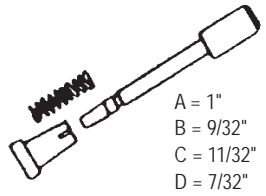

A = 1"  
B = 9/32"  
C = 11/32"  
D = 7/32"

**90-312**  
Snap-On Knob, White Plastic  
Metal Plunger

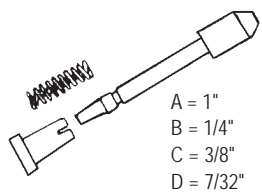

A = 1"  
B = 1/4"  
C = 3/8"  
D = 7/32"

**90-14**  
Snap-On Plastic Knob, White

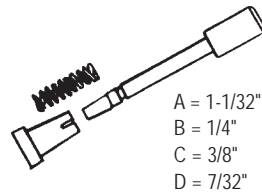

A = 1-1/32"  
B = 1/4"  
C = 3/8"  
D = 7/32"

**90-11**  
Snap-On Plastic Knob, Black

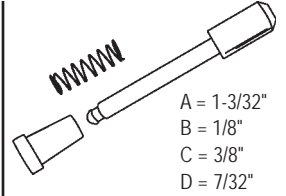

A = 1-3/32"  
B = 1/8"  
C = 3/8"  
D = 7/32"

Part #	Knob
900-9850	White
900-9850B	Black

Snap-On Plastic Knob, Metal  
Plunger

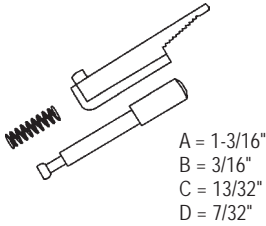

A = 1-3/16"  
B = 3/16"  
C = 13/32"  
D = 7/32"

Part #	Knob	Hand
900-9850FT	White	RH
900-9850FTL	White	LH

Flip Type

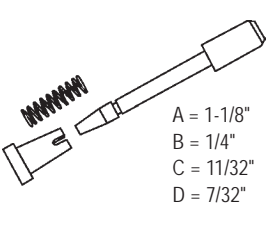

A = 1-1/8"  
B = 1/4"  
C = 11/32"  
D = 7/32"

Part #	Knob
90-24	White
90-24B	Black

Snap-On Plastic Knob, Metal  
Plunger

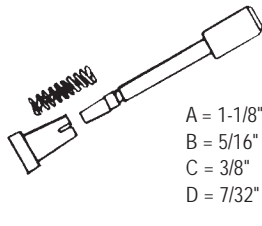

A = 1-1/8"  
B = 5/16"  
C = 3/8"  
D = 7/32"

**90-13**  
Snap-On Plastic Knob, White  
Plastic Plunger

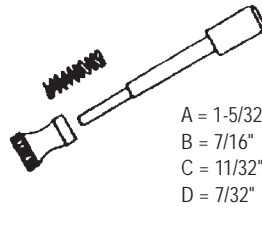

A = 1-5/32"  
B = 7/16"  
C = 11/32"  
D = 7/32"

**90-375**  
Stake-On Metal Knob  
Metal Plunger

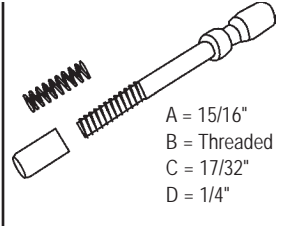

A = 15/16"  
B = Threaded  
C = 17/32"  
D = 1/4"

**90-371**  
Metal Screw-On Knob  
Metal Plunger

## FRICTION HANGERS

## LATCH SET

## WARNING LABEL

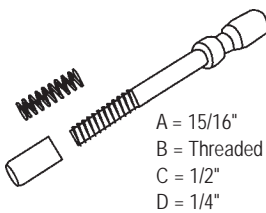

A = 15/16"  
B = Threaded  
C = 1/2"  
D = 1/4"

**90-370**  
Metal Screw-On Knob  
Metal Plunger

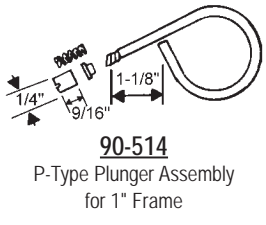

**90-514**  
P-Type Plunger Assembly  
for 1" Frame

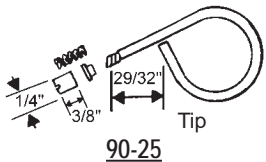

**90-25**  
Tip



Part #	Frame Thickness	Color
90-120	3/8"	Aluminum
90-389	7/16"	Aluminum
90-389W	7/16"	White
90-389BZ	7/16"	Bronze

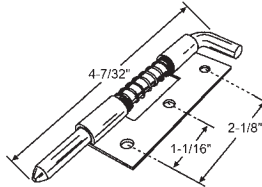

**90-736**  
Low Profile Latch Set  
Sold in Sets Only.

**WARNING!**  
DO NOT USE SCR FROM WINDOWS. Insect screens are not intended to protect persons within the out the window.

**500-287**  
1000 Per Roll  
1/2" x 2-3/4"

## PET SCREEN DOOR

## SCREEN SHIELD

## AUTOMATIC SCREEN DOOR CLOSER

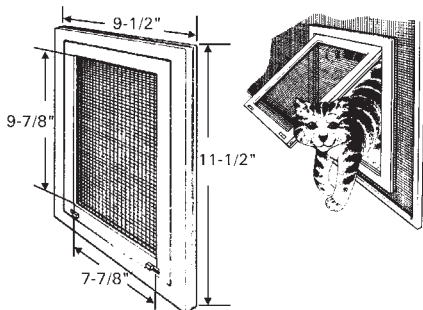

**990-2**  
Pet Screen  
Bronze

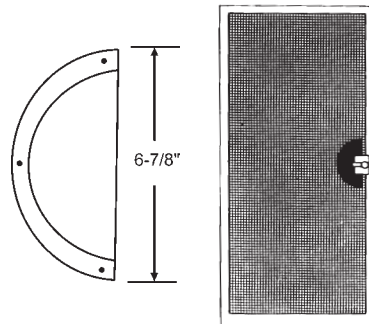

**16-191**  
Screen Shield. Protects Screening Around Door Handle.  
Snaps Together. Durable Plastic

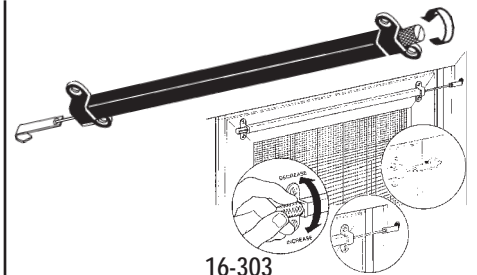

**16-303**  
Screen Door Closer with Screws. Black. Fits Patio  
Screen Doors 36" and Larger. Simple Installation  
Takes Only Minutes. Block And Tackle Design  
Provides Smooth Operation.



## CUSTOM MADE EXTRUDED ALUMINUM WICKET & HOPPER SCREENS ORDER FORM

Customer Name: \_\_\_\_\_ Account Number \_\_\_\_\_

Contact: \_\_\_\_\_ Phone Number \_\_\_\_\_

Quantity: \_\_\_\_\_ Cost: \_\_\_\_\_ Signature \_\_\_\_\_ Date \_\_\_\_\_

### For Commercial & Institutional Application

Frame: .050 Gauge, 6063 T5 Aluminum Alloy

#### 1. Select Frame Profile/Color



90-531M



90-509M

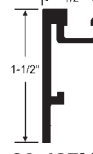

90-497M

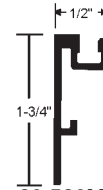

90-530M

- Mill
- Bronze
- White

#### 2. Select Screen Wire

Bright Aluminum

Charcoal Aluminum

Gray Fiberglass

Charcoal Fiberglass

#### 3. Select Type

Single Wicket Screen  
 Hinged  Sliding

Wicket Size \_\_\_\_\_ W x \_\_\_\_\_ H

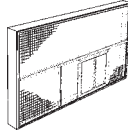

Hopper Screen

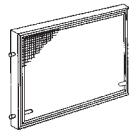

Double Wicket Screen  
 Hinged  Sliding

Wicket Size \_\_\_\_\_ W x \_\_\_\_\_ H

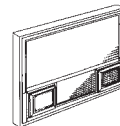

Full Height Hinged Wicket Screen

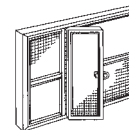

Other

\_\_\_\_\_  
 (Specify)

4. Screen Size: \_\_\_\_\_ W x \_\_\_\_\_ H

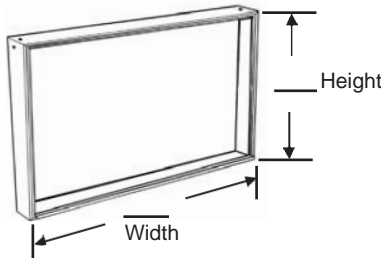

#### 6. Measuring Instructions:

For Hardware to be Installed

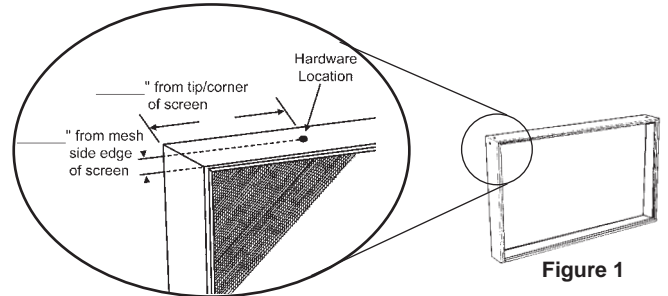
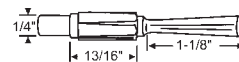

Figure 1

5. Quantity \_\_\_\_\_

#### 7. Hardware & Hardware Location:

- Hardware to be installed on \_\_\_\_\_ rail (See Figure 2). Part No. \_\_\_\_\_  
 Location: \_\_\_\_\_ " from tip/corner of screen (See Figure 1)  
 \_\_\_\_\_ " in from mesh side edge of screen (See Figure 1)
- Hardware to be installed on \_\_\_\_\_ rail (See Figure 2). Part No. \_\_\_\_\_  
 Location: \_\_\_\_\_ " from tip/corner of screen (See Figure 1)  
 \_\_\_\_\_ " in from mesh side edge of screen (See Figure 1)
- Hardware to be installed on \_\_\_\_\_ rail (See Figure 2). Part No. \_\_\_\_\_  
 Location: \_\_\_\_\_ " from tip/corner of screen (See Figure 1)  
 \_\_\_\_\_ " in from mesh side edge of screen (See Figure 1)
- Hardware to be installed on \_\_\_\_\_ rail (See Figure 2). Part No. \_\_\_\_\_  
 Location: \_\_\_\_\_ " from tip/corner of screen (See Figure 1)  
 \_\_\_\_\_ " in from mesh side edge of screen (See Figure 1)



90-100NS

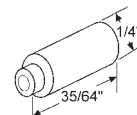

90-551

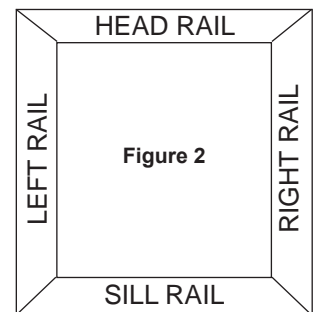

Figure 2

**IMPORTANT:** Hardware must be located by position. In the spaces above please indicate both height & width AND depth of frame.

**Please Call for Pricing and Delivery**

# SCREEN HARDWARE

## CUSTOM MADE ROLL FORM & EXTRUDED ALUMINUM WICKET SCREENS WITH PLASTIC WICKET ORDER FORM

Customer Name: \_\_\_\_\_ Account Number \_\_\_\_\_

Contact: \_\_\_\_\_ Phone Number \_\_\_\_\_

Quantity: \_\_\_\_\_ Screen Size: Width \_\_\_\_\_ x Height \_\_\_\_\_

Cost: \_\_\_\_\_ Signature \_\_\_\_\_ Date \_\_\_\_\_

### ROLLED FORM ALUMINUM WICKET SCREENS WITH PLASTIC WICKETS

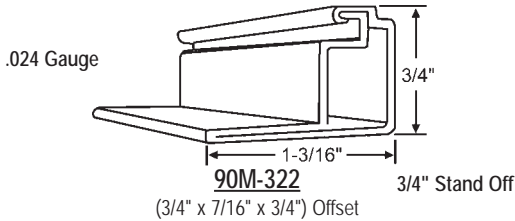

Description
With Fiberglass Mesh
With Aluminum Mesh
Frame Only Available in White

### EXTRUDED ALUMINUM WICKET SCREENS WITH PLASTIC WICKETS

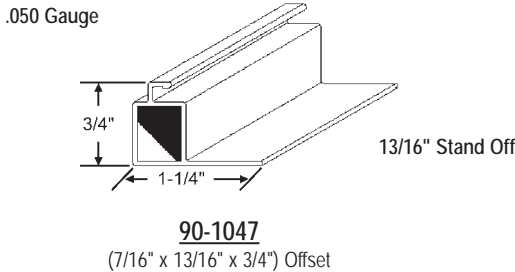

Description
with Fiberglass Mesh
with Aluminum Mesh

- Select Frame Color:  Mill  Bronze  White  Beige
- Select Wicket Color:  Black  White  Gray  Dark Bronze (Brown)
- Select Screen Wire:  Bright Aluminum  Charcoal Aluminum  Gray Fiberglass  Charcoal Fiberglass
- Select Wicket Type: NOTE: Minimum 2 Screens per size & color

- Single Hinged Wicket Screen  Double Hinged Wicket Screen  Hopper Screen

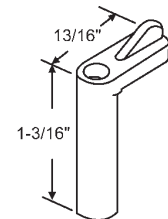
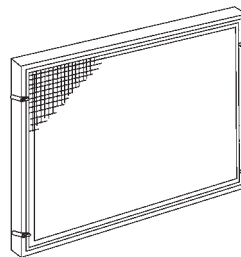
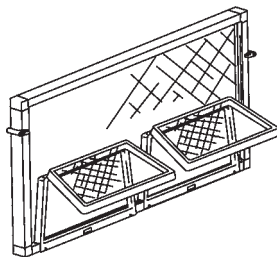
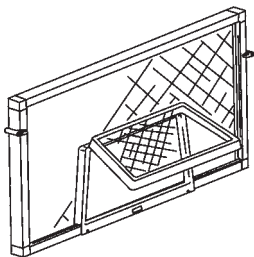

- Notes:
- Plastic Hinged Wicket is 10-1/8" Wide x 6-1/8" High
  - All Wicket Screens come Standard with 90-727 Swivel Clips.

Please call for pricing and delivery. A packaging charge will be assessed for quantities less than 10. An additional charge will be assessed for each wicket attached to screen

### PLASTIC HINGED WICKETS ONLY

For Casement or Awning Type Window Screens

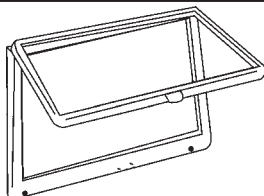

Part #	Color
900-15154	Gray
900-15154W	White
900-15154B	Black
900-15154DB	Dark Bronze (Brown)

- Snap-Type Latch for Sure Closure
- Allows Easy Access to Operator
- Install Your Own Matching Wire
- Pop Rivet to Screen Frame
- Size: 10-1/8" x 6-1/8"
- Very Economical
- Hinges Full 180°

## CUSTOM MADE PATIO SCREEN DOOR ORDER FORM

Account# \_\_\_\_\_ Salesman \_\_\_\_\_ Page# \_\_\_\_\_ of \_\_\_\_\_

Sold To: \_\_\_\_\_ Ship To: \_\_\_\_\_

Purchase Order# \_\_\_\_\_ Date \_\_\_\_\_ Quoted By \_\_\_\_\_

**STEP 1 Determine style and material of door**

- Custom Roll Form Aluminum
- Custom Roll Form Steel
- Multi-Fit Roll Form Aluminum
- Custom Extruded Aluminum

**STEP 2 Determine finish**

- Mill (Aluminum Doors) - Not Available for MOOSE
- Gray (Steel Doors)
- White
- Bronze
- Other \_\_\_\_\_

**STEP 3 Select screen cloth or screen wire**

- Charcoal Fiberglass (standard)
- Gray Fiberglass
- Bright Aluminum
- Charcoal Aluminum
- Other \_\_\_\_\_
- None (Apply's only to Riviera, Deluxe, Regal & Majestic Knocked Down Doors)

**STEP 4 Select type of wheel**

- Nylon
- Steel
- Stainless Steel

**STEP 5 Determine head and sill rail depth**

- (Note: Deep head/sill only available on assembled Apollo custom aluminum doors)
- 1/16" to 1/4" (standard)
  - 5/16" to 5/8"

**STEP 6 Lock Assembly Location:**

- Centered (Reversible)
  - Inches \_\_\_\_\_
- Measure from the top of the sill track bead up to the center of the existing keeper.
- View from the Inside Looking Out:  RH  LH (check one)

**STEP 7 Bug Seal:**

- Vinyl Bug Flap - Circle Size:      7/8"      1-1/8"      1-1/2"
- Wool Pile - Circle Size:      .250"      .350"      .380"      .450"
- .500"      .600"      .650"      .750"

**STEP 8 Measuring Instructions for Custom Screens**

**Width:** Measure from inside the jamb to the center of the first rail of the fixed door.

**Height:** See Illustration:

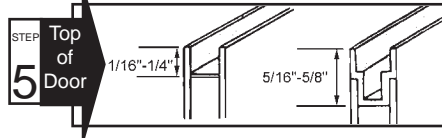
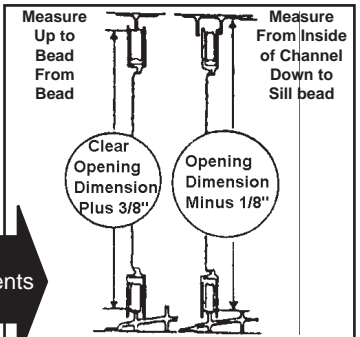

**STEP 9 Select Part Number, Quantity & Size**

- 991M-999 ENTERPRISE Custom Roll Form Steel - Assembled
- 997M-999 BOSS Heavy Duty Custom Roll Form Steel - Assembled
- 992M-999 APOLLO Custom Roll Form Aluminum - Assembled
- 995M-999 TITAN Classic Custom Extruded Aluminum - Assembled
- 998M-999 TITAN Contemporary Custom Extruded Aluminum - Assembled
- 996-999 MOOSE Custom Extruded Aluminum - Assembled
- 999M-999 GEMINI Custom Extruded Aluminum - Assembled
- 995F-999 DELUXE Custom Extruded Aluminum - Assembled
- 998F-999 REGAL Custom Extruded Aluminum - Assembled
- 996F-999 MAJESTIC Custom Extruded Aluminum - Assembled
- 999F-999 RIVIERA Custom Extruded Aluminum - Assembled
- 991M-999KD ENTERPRISE Custom Roll Form Steel - Knocked Down
- 997M-999KD BOSS Heavy Duty Custom Roll Form Steel - Knocked Down
- \* 992M-999KD APOLLO Custom Roll Form Aluminum - Knocked Down
- 995M-999KD TITAN Classic Custom Extruded Aluminum - Knocked Down
- 998M-999KD TITAN Contemporary Custom Extruded Aluminum - Knocked Down
- 996-999KD MOOSE Custom Extruded Aluminum - Knocked Down
- 999M-999KD GEMINI Custom Extruded Aluminum - Knocked Down
- 995F-999KD DELUXE Custom Extruded Aluminum - Knocked Down
- 998F-999KD REGAL Custom Extruded Aluminum - Knocked Down
- 996F-999KD MAJESTIC Custom Extruded Aluminum - Knocked Down
- 999F-999KD RIVIERA Custom Extruded Aluminum - Knocked Down

\*Note: Cloth and Spline are not included with Apollo Knocked Down Doors

Part#	Quantity	Size	Price Each	Amount
		_____ " width x _____ " height		
891-999-3		Less than 10 charge	\$ _____	
891-999-1		Less than 5 charge	\$ _____	
891-999-2		Top Hung System	\$ _____	
			<b>TOTAL</b>	
			<b>FREIGHT</b>	

I understand that this material is not regular stock, but custom made to specifications as stated above. I understand and accept the condition that this material is NON RETURNABLE and NON-CANCELABLE. See Specific Series for Prepaid Freight Terms. IT IS THE RESPONSIBILITY OF THE CUSTOMER TO INSPECT FOR DAMAGE, AND MAKE THE CLAIM WITH THE CARRIER, AS WE ARE NOT RESPONSIBLE FOR DAMAGE.

**\*Please Note\*: Carrier charges continue to fluctuate. Please call for delivery charges.**

Signature of Authorized Buyer \_\_\_\_\_ Buyer Phone \_\_\_\_\_

Title \_\_\_\_\_

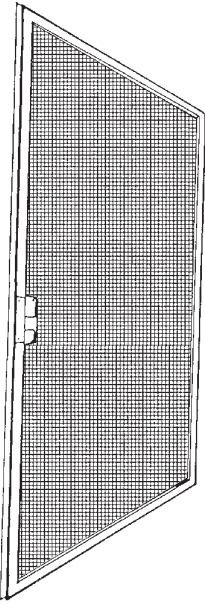

- Vinyl Bug Flap (Standard)
- Reversible for right or left hand doors
- Available in Gray or Charcoal Fiberglass Cloth (Standard)
- Replaces Patio Screen Doors with 1/16" to 3/16" sill/track bead height
- Each door includes: latch, keeper, rollers, bug seal and instructions
- Spring loaded latch will not break when door is slammed
- Custom made to fit width and height openings
- Frame size is 1/2" thick x 1-5/8" wide
- Frame size is 1-3/4" thick x 2" wide (Boss Steel Heavy Duty)
- Additional charges apply for steel rollers.
- Additional charges apply for stainless steel rollers & coastal hardware.
- Additional charges apply for aluminum wire.
- Additional charges apply for woolpile.
- Freight: FOB Shipping Point

**FREIGHT PRE-PAID!**  
 on 125+ combination of all styles, sizes and colors.  
 WITHIN CONTINENTAL UNITED STATES  
 EXCLUDES ALASKA & HAWAII

**Top Hung System**  
**Now Available for Top Rolling Application!**  
 Includes top hung adapter & track. Additional charges apply.

### Steel Custom Made Patio Screen Doors ENTERPRISE - 991M-999 (Standard)

Made of .019 Gauge Roll form Steel  
 Colors Available: Gray, White, Almond, Beige, Sandstone, Bronze

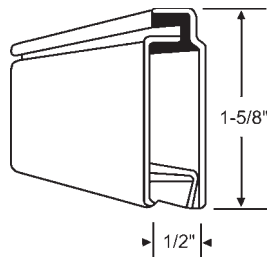

### Steel Custom Made Patio Screen Doors BOSS - 997M-999 (Heavy Duty)

Made of .019 Gauge Roll form Steel  
 Colors Available: Gray, White, Almond, Bronze

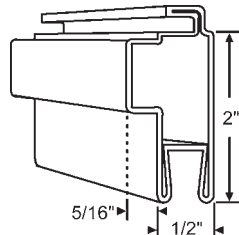

#### PRE-ASSEMBLED & KNOCKED DOWN

Width x Height
up to 33" x up to 83"
up to 39" x up to 83"
up to 51" x up to 83"
up to 61" x up to 83"
up to 33" x up to 105"
up to 39" x up to 105"
up to 51" x up to 105"

#### PRE-ASSEMBLED & KNOCKED DOWN

Width x Height
up to 33" x up to 83"
up to 39" x up to 83"
up to 51" x up to 83"
up to 61" x up to 83"
up to 33" x up to 105"
up to 39" x up to 105"
up to 51" x up to 105"
up to 61" x up to 105"

**Steel Custom Made Patio Screen Doors are not Available with Deephead and Deepsill.**

Freight on all doors will be prepaid on 125+ combination of all styles, sizes, and colors.  
 Within Continental United States. Excludes Alaska & Hawaii

Pre-Assembled Steel & Aluminum Roll Form Doors are sold either 10 per color per size or 5 per color per size. Any quantity other than a multiple of 10 or 5 will be assessed with a single packaging charge per screen.

**CARRIER CHARGES CONTINUE TO FLUCTUATE. PLEASE CALL FOR DELIVERY CHARGES**

ALUMINUM CUSTOM PATIO SCREEN DOORS

**FREIGHT PRE-PAID!**  
 on 125+ combination of all styles, sizes and colors.  
 WITHIN CONTINENTAL UNITED STATES EXCLUDES ALASKA & HAWAII

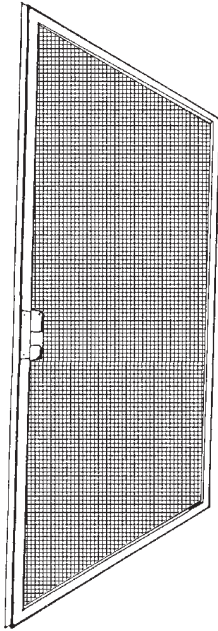

- Vinyl Bug Flap (Standard)
- Reversible for right or left hand doors
- Available in Gray or Charcoal Fiberglass Cloth (Standard)
- Replaces patio screen doors with 1/16" to 3/16" sill/track bead height
- Each door includes: latch, keeper, rollers, bug seal and instructions
- Spring loaded latch will not break when door is slammed
- Custom made to fit width and height openings
- Frame size is 1/2" thick x 1-5/8" wide
- Additional charges apply for steel rollers.
- Additional charges apply for stainless steel rollers & coastal hardware.
- Additional charges apply for aluminum wire.
- Additional charges apply for woolpile.
- Freight: FOB Shipping Point

**Top Hung System**  
**Now Available for Top Rolling Application!**  
 Includes top hung adapter & track. Additional charges apply.

**Aluminum Custom Made Patio Screen Doors**  
**APOLLO - #992M-999**

Made of .038 Gauge Roll form Aluminum  
 Colors Available: Mill, White, Almond, Bronze

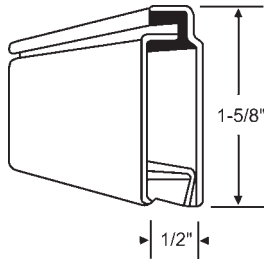

**PRE-ASSEMBLED\***

Width x Height
up to 33" x up to 83"
up to 39" x up to 83"
up to 51" x up to 83"
up to 61" x up to 83"
up to 33" x up to 105"
up to 39" x up to 105"
up to 51" x up to 105"

**KNOCKED DOWN - #992M-999KD**

Width x Height
24" to 30" x up to 80"
31" to 36" x up to 80"
37" to 48" x up to 80"
49" to 60" x up to 80"
24" to 30" x up to 96"
31" to 36" x up to 96"
37" to 48" x up to 96"
49" to 60" x up to 96"

A more cost effective way to order Patio Screen Doors  
**Save on Freight Costs • Less Storage Space Needed • Build as You Need**

Freight on all doors will be prepaid on 125+ combination of all styles, sizes, and colors.  
 Within Continental United States. Excludes Alaska & Hawaii.

Pre-Assembled Steel & Aluminum Roll Form Doors are sold either 10 per color, per size or 5 per color per size. Any quantity other than a multiple of 10 or 5 will be assessed with a single packaging charge per screen.

**CARRIER CHARGES CONTINUE TO FLUCTUATE. PLEASE CALL FOR DELIVERY CHARGES.**

## ALUMINUM KNOCKED DOWN PATIO SCREEN DOORS

### APOLLO Aluminum Rollform

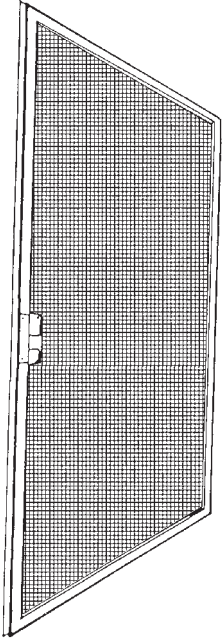

- Frame size is 1/2" thick x 1-5/8" wide
  - Reversible for right or left hand doors
  - Made of .038 Gauge Rollform Aluminum
  - Above doors are WITHOUT cloth or spline
  - Spring loaded latch will not break when door is slammed
  - Each door includes: latch, keeper, rollers and bug seal.
  - Comes standard with nylon wheels.
  - Replaces Patio Screen Doors with 1/16" to 3/16" sill/track bead height
  - Additional charges apply for steel rollers.
- Note: Maximum cut is 1/2" from each end of width, without having to re-drill hole.

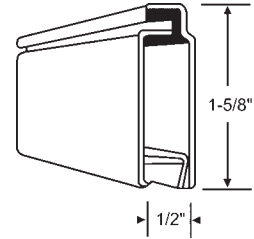

#### COMBINE SIZES TO GET QUANTITY DISCOUNTS

Part #	Size	Color
92-1KD	30" x 81"	Mill
92-2KD	30" x 81"	Bronze
92-3KD	30" x 81"	White
92-4KD	36" x 81"	Mill
92-5KD	36" x 81"	Bronze
92-6KD	36" x 81"	White
92-7KD	48" x 81"	Mill
92-8KD	48" x 81"	Bronze
92-9KD	48" x 81"	White

The Above Screen Frame Uses .140 - 9/64" Spline

## ALUMINUM CUSTOM PATIO SCREEN DOORS

### GEMINI Custom Extruded 999M-999

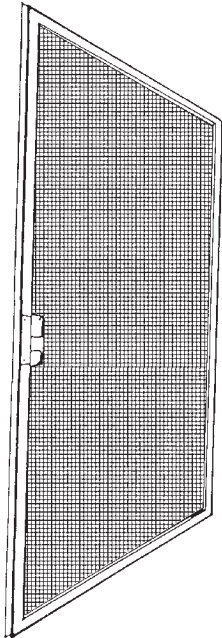

- Vinyl Bug Flap (Standard)
- Reversible for right or left hand doors
- Available in Gray or Charcoal Fiberglass Cloth (Standard)
- Available in Mill, Bronze, Almond, White, Beige
- Replaces Patio Screen Doors with 1/16" to 3/16" sill/track bead height
- Each door includes: latch, keeper, rollers, bug seal and instructions
- Spring loaded latch will not break when door is slammed
- Custom made to fit width and height openings
- Prices are for Standard Patio Screen Doors
- Frame size is 1/2" thick x 1-5/8" wide
- Additional charges apply for steel rollers.
- Additional charges apply for stainless steel rollers & coastal hardware.
- Additional charges apply for aluminum wire.
- Additional charges apply for woolpile.
- Freight: FOB Shipping Point

Made of .040 Gauge Extruded Aluminum

Width x Height
up to 33" x up to 83"
up to 39" x up to 83"
up to 51" x up to 83"
up to 61" x up to 83"
up to 33" x up to 103"
up to 39" x up to 103"
up to 51" x up to 103"
up to 61" x up to 103"

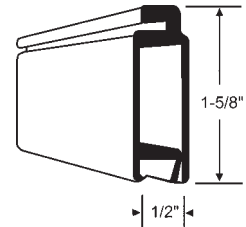

#### Top Hung System Now Available for Top Rolling Application!

Includes top hung adapter & track. Additional charges apply.



Note: Gemini doors are available in K/D form.

Freight on all doors will be prepaid on 125+ combination of all styles, sizes, and colors. Within Continental United States. Excludes Alaska & Hawaii.

Pre-Assembled Steel & Aluminum Roll Form Doors are sold either 10 per color, per size or 5 per color per size. Any quantity other than a multiple of 10 or 5 will be assessed with a single packaging charge per screen.

**CARRIER CHARGES CONTINUE TO FLUCTUATE. PLEASE CALL FOR DELIVERY CHARGES.**

## ALUMINUM CUSTOM PATIO SCREEN DOORS

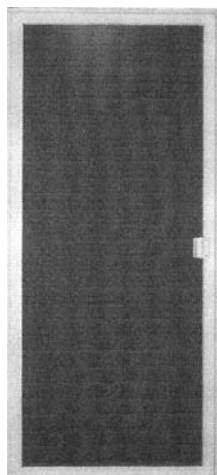

### TITAN

Custom Extruded  
995M-999 - Classic  
998M-999 - Contemporary

- Frame size 1/2" x 2" wide • Reversible for right or left hand doors
- Custom made to fit width and height openings
- Made of heavy duty .040 gauge extruded aluminum
- Available In mill, white, bronze, almond and beige
- Available In two designs: classic and contemporary
- Comes standard with top adjusting nylon roller, upgraded handle system, and vinyl bug flap
- Each door includes: latch, keeper, and instructions
- Affordable upgrade from a roll formed door
- Additional charges apply for steel rollers.
- Additional charges apply for stainless steel rollers & coastal hardware.
- Additional charges apply for aluminum wire.
- Additional charges apply for woolpile.
- Freight: FOB Shipping Point



**Top Hung System**  
**Now Available for Top Rolling Application!**  
Includes top hung adapter & track. Additional charges apply.



#### PRE-ASSEMBLED\*

Width x Height
up to 33" x up to 83"
up to 39" x up to 83"
up to 51" x up to 83"
up to 61" x up to 83"
up to 33" x up to 103"
up to 39" x up to 103"
up to 51" x up to 103"
up to 61" x up to 103"

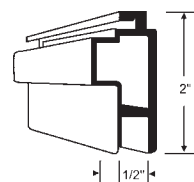

Classic Design

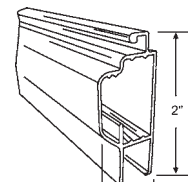

Contemporary Design

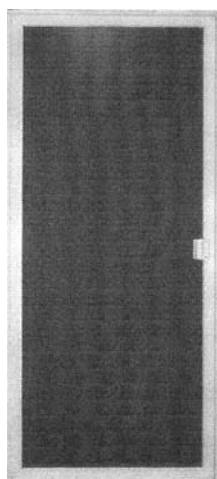

### THE MOOSE™

#### Custom Extruded 996-999

*A Good Substitute to Replace Andersen Screen Door*

- Available in white, almond and bronze
- Features our own premium locking handle and strike
- Offer your customers the ultimate upgrade in a rolling patio door screen
- Especially well designed to match the profiles of the best wood patio doors
- Rolls quietly and effortlessly on steel ball bearing wheels that can easily adjusted to fit your opening
- Enhance your product image with our heavy duty frame design, with walls a full .050" thick
- Individually packed with all necessary hardware and installation guidelines
- Additional charges apply for steel rollers.
- Additional charges apply for stainless steel rollers & coastal hardware.
- Additional charges apply for aluminum wire.
- Additional charges apply for woolpile.
- Freight: FOB shipping point

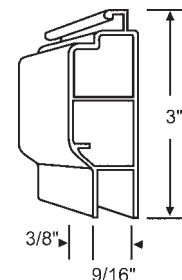

**Top Hung System**  
**Now Available for Top Rolling Application!**  
Includes top hung adapter & track. Additional charges apply.



#### PRE-ASSEMBLED\*

Width x Height
up to 33" x up to 83"
up to 39" x up to 83"
up to 51" x up to 83"
up to 61" x up to 83"
up to 33" x up to 115"
up to 39" x up to 115"
up to 51" x up to 115"
up to 61" x up to 115"

Note: Both Titan and Moose doors are available in K/D form.

Freight on all doors will be prepaid on 125+ combination of all styles, sizes, and colors. Within Continental United States. Excludes Alaska & Hawaii.

Pre-Assembled Steel & Aluminum Roll Form Doors are sold either 10 per color per size or 5 per color, per size. Any quantity other than a multiple of 10 or 5 will be assessed with a single packaging charge per screen.

**CARRIER CHARGES CONTINUE TO FLUCTUATE. PLEASE CALL FOR DELIVERY CHARGES.**

### RIVIERA 999F-999 Assembled 999F-999KD Knock Down

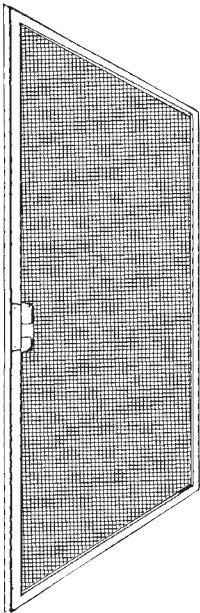

Size
up to 30" X up to 80"
up to 36" X up to 80"
up to 48" X up to 80"
up to 60" X up to 80"
up to 30" X up to 96"
up to 36" X up to 96"
up to 48" X up to 96"
up to 60" X up to 96"

- Frame Size is 1/2" Thick x 1-5/8" Wide
- Made of .050 Gauge Extruded Aluminum
- Reversible for Right or Left Hand Doors
- Comes with Handle Pull on Both Sides of Screen
- Available in Mill, White, Almond and Bronze
- Vinyl Bug Flap (Standard)
- Fiberglass Cloth (Standard)
- Knocked Down Version Comes Standard with No Cloth or Spline
- Additional charges apply for Adding Cloth and Spline for Knock Down Version
- Additional charges apply for Stainless Steel Rollers
- Additional charges apply for Aluminum Wire
- Additional charges apply for Adhesive Backed .250 Woolpile
- Additional charges apply for Oversized Door (Oversized Door is any Door Wider then 60" and Higher then 96")
- Additional charges apply for Astragals
- Additional charges apply for Top Hung System
- Additional charges apply for Cross Brace
- Freight: FOB Shipping Point

**FREIGHT PRE-PAID!**  
on 100+ combination of all sizes & colors of Riviera, Deluxe, Regal and Majestic doors.  
WITHIN CONTINENTAL UNITED STATES EXCLUDES ALASKA & HAWAII

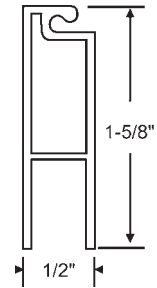

Assembled Doors Pack 5 Per Size Per Color. If Ordering Less then 5 Per Size Per Color, Additional Charges Apply.

### DELUXE 995F-999 Assembled 995F-999KD Knock Down

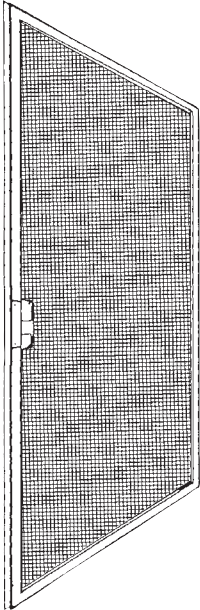

Size
up to 30" X up to 80"
up to 36" X up to 80"
up to 48" X up to 80"
up to 60" X up to 80"
up to 30" X up to 96"
up to 36" X up to 96"
up to 48" X up to 96"
up to 60" X up to 96"

- Frame Size is 1/2" Thick x 2" Wide
- Made of .050 Gauge Extruded Aluminum
- Reversible for Right or Left Hand Doors
- Comes with Handle Pull on Interior of Door Only.
- Available in Mill, White, Almond and Bronze
- Vinyl Bug Flap (Standard)
- Fiberglass Cloth (Standard)
- Knocked Down Version Comes Standard with No Cloth or Spline
- Additional charges apply for Adding Cloth and Spline for Knock Down Version
- Additional charges apply for Stainless Steel Rollers
- Additional charges apply for Aluminum Wire
- Additional charges apply for Adhesive Backed .250 Woolpile
- Additional charges apply for Oversized Door (Oversized Door is any Door Wider then 60" and Higher then 96")
- Additional charges apply for Astragals
- Additional charges apply for Top Hung System
- Additional charges apply for Cross Brace
- Freight: FOB Shipping Point

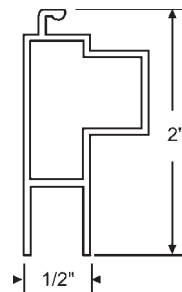

Assembled Doors Pack 5 Per Size Per Color. If Ordering Less then 5 Per Size Per Color, Additional Charges Apply.



## EXTRUDED ALUMINUM CUSTOM PATIO SCREEN DOORS

### REGAL

998F-999 Assembled  
998F-999KD Knock Down

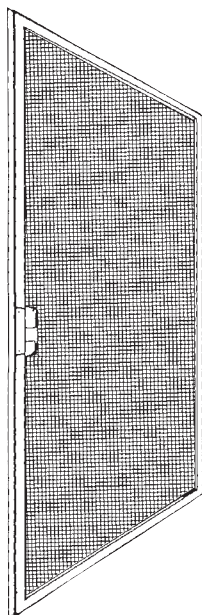

Size
up to 30" X up to 80"
up to 36" X up to 80"
up to 48" X up to 80"
up to 60" X up to 80"
up to 30" X up to 96"
up to 36" X up to 96"
up to 48" X up to 96"
up to 60" X up to 96"

- Frame Size is 1/2" Thick x 2" Wide
- Made of .050 Gauge Extruded Aluminum
- Reversible for Right or Left Hand Doors
- Comes with Handle Pull on Interior of Door Only.
- Available in Mill, White, Almond and Bronze
- Vinyl Bug Flap (Standard)
- Fiberglass Cloth (Standard)
- Knocked Down Version Comes Standard with No Cloth or Spline
- Additional charges apply for Adding Cloth and Spline for Knock Down Version
- Additional charges apply for Stainless Steel Rollers
- Additional charges apply for Aluminum Wire
- Additional charges apply for .580 or .370 Slide in Woolpile
- Additional charges apply for Oversized Door  
(Oversized Door is any Door Wider then 60" and Higher then 96")
- Additional charges apply for Recessed Handle (only available on Regal)
- Additional charges apply for Astragals
- Additional charges apply for Top Hung System
- Additional charges apply for Cross Brace
- Freight: FOB Shipping Point

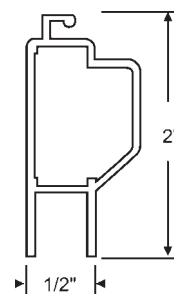

Assembled Doors  
Pack 5 Per Size Per  
Color. If Ordering  
Less then 5 Per Size  
Per Color, Additional  
Charges Apply.

### MAJESTIC

996F-999 Assembled  
996F-999KD Knock Down

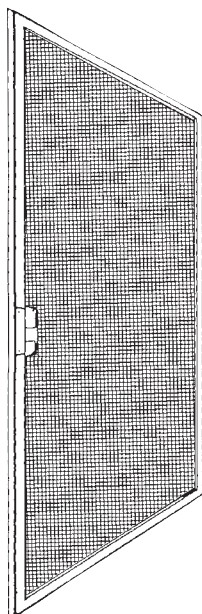

Size
up to 30" X up to 80"
up to 36" X up to 80"
up to 48" X up to 80"
up to 60" X up to 80"
up to 30" X up to 96"
up to 36" X up to 96"
up to 48" X up to 96"
up to 60" X up to 96"

- Frame Size is 1/2" Thick x 3" Wide
- Made of .050 Gauge Extruded Aluminum
- Reversible for Right or Left Hand Doors
- Available in Mill, White, Almond and Bronze
- Vinyl Bug Flap (Standard)
- Fiberglass Cloth (Standard)
- Knocked Down Version Comes Standard with No Cloth or Spline
- Additional charges apply for Adding Cloth and Spline for Knock Down Version
- Additional charges apply for Stainless Steel Rollers
- Additional charges apply for Aluminum Wire
- Additional charges apply for Adhesive Backed .250 Woolpile
- Additional charges apply for Oversized Door  
(Oversized Door is any Door Wider then 60" and Higher then 96")
- Additional charges apply for Astragals
- Additional charges apply for Top Hung System
- Additional charges apply for Cross Brace
- Freight: FOB Shipping Point

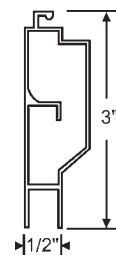

Assembled Doors  
Pack 5 Per Size Per  
Color. If Ordering  
Less then 5 Per Size  
Per Color, Additional  
Charges Apply.

## STEEL MULTI-FIT PATIO SCREEN DOORS

### COMBINE SIZES TO GET QUANTITY DISCOUNTS

*Note: This is a painted galvanized steel product. No warranty is given, written, or inferred against rusting, corrosion or reactions against dissimilar metals.*

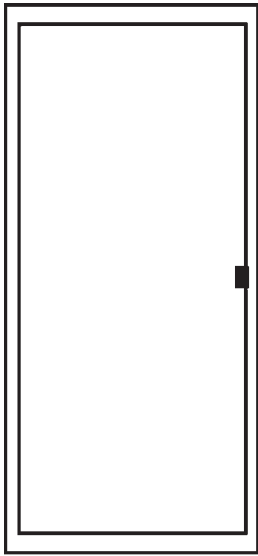

Standard

- Made of .019 gauge rollform steel
- Reversible for right or left hand doors
- Replaces 90% of existing patio screen doors
- Steel wheels available, add \$2.25 to cost of screen (Standard on Heavy Duty Door)
- Available in gray or charcoal fiberglass cloth -standard
- Bright and charcoal aluminum wire available add 35% to cost of screen
- Complete with latch, door pull, keeper, non-adjusting nylon rollers, bug strip and instructions
- Comes with heavy duty top & bottom expanders allowing the doors to adjust from 78" to 80" for a custom fit
- Tear away vinyl bug flap is designed for hand peeling to custom fit your door
- Easy access field adjustments for quick installation
- Patio doors are 1/2" thick x1-5/8" wide (Standard) or 3/4" x 2" (Heavy Duty)
- Freight: FOB shipping point

#### STANDARD PRE-ASSEMBLED\*

Part #	Size	Color
93-1	30"	Gray
93-2	36"	Gray
93-3	48"	Gray
93-4	60"	Gray
93-5	30"	Earthtone Bronze
93-6	36"	Earthtone Bronze
93-7	48"	Earthtone Bronze
93-8	60"	Earthtone Bronze
93-9	30"	White
93-10	36"	White
93-11	48"	White
93-12	60"	White

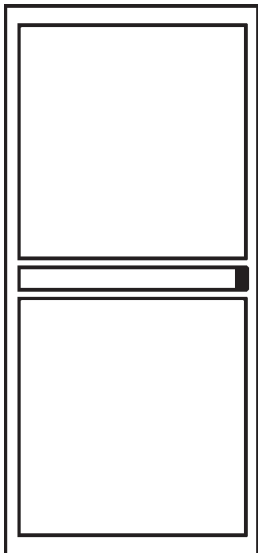
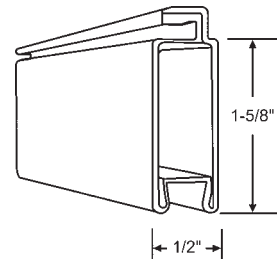

Heavy Duty

(Includes 2 Removable Push Bars, Steel Rollers and HD Latching Handle)

#### HEAVY DUTY PRE-ASSEMBLED\*

Part #	Size	Color
997-1	30"	Gray
997-2	36"	Gray
997-3	48"	Gray
997-5	30"	Earthtone Bronze
997-6	36"	Earthtone Bronze
997-7	48"	Earthtone Bronze
997-9	30"	White
997-10	36"	White
997-11	48"	White

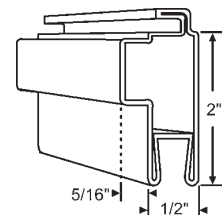

Freight on all doors will be prepaid on 125+ combination of all styles, sizes, and colors. (Within Continental United States. Excludes Alaska & Hawaii)

Pre-Assembled Steel & Aluminum Roll Form Doors are sold either 10 per color per size or 5 per color, per size. Any quantity other than a multiple of 10 or 5 will be assessed with a single packaging charge per screen.

**CARRIER CHARGES CONTINUE TO FLUCTUATE. PLEASE CALL FOR DELIVERY CHARGES.**

## TOP HUNG SYSTEM FOR TOP ROLLING APPLICATION

### EXPLODED PARTS VIEW



Top Hung Track

Top Hung Adapter

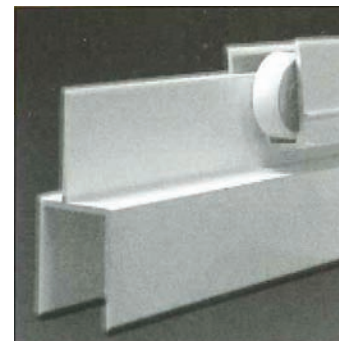

CLOSE-UP ROLLER VIEW

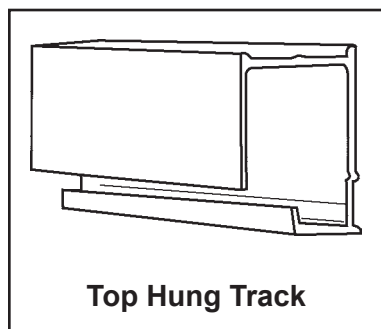

Top Hung Track

### Top Hung Adapters

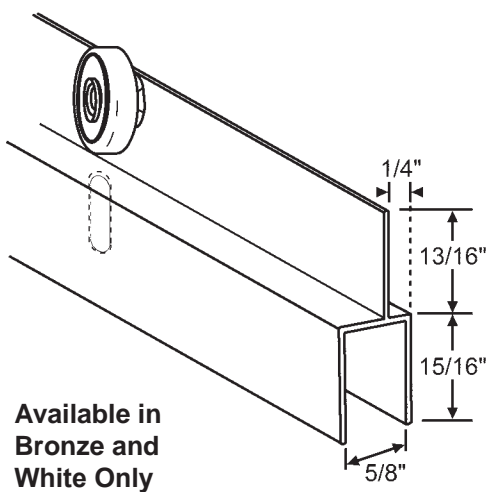

Available in  
Bronze and  
White Only

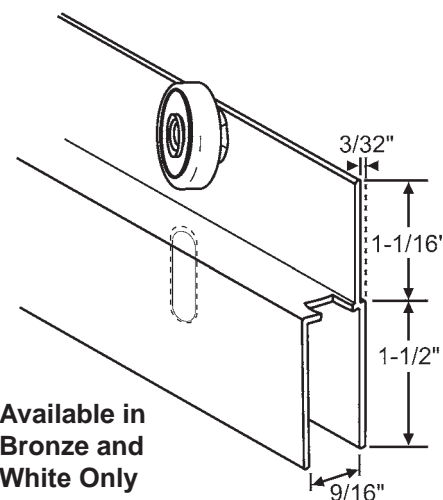

Available in  
Bronze and  
White Only

8 Ft. Top Hung Track	Colors	30" Top Hung Adapter	36" Top Hung Adapter	48" Top Hung Adapter
90M-640BZ	Bronze	90M-637BZ	90M-638BZ	90M-639BZ
		90M-641BZ	90M-642BZ	90M-643BZ
90M-640W	White	90M-637W	90M-638W	-
		90M-641W	90M-642W	90M-643W

# SCREEN HARDWARE

## SCREEN TOOLS

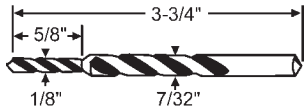

### 59-51

Step Drill. For plunger with 7/32" tip. High speed hardened steel step drill makes two diameter holes in one pass for a precise screen plunger fit.



### 59-44

Concave Roller/Cutter  
Steel Wheel

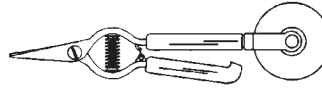

### 59-45

Cloth Cutter with Steel Wheel



Part #	Description
59-10	5/32" Wheel
59-10SP	1/16" Wheel

Plastic Roller and Housing

### Screen Spline and Screen Wire Installation Tool

A professional tool with wood handle and steel enclosed ball bearing rollers. Use convex roller of installation tool to roll screen wire into slot of screen frame; use concave roller to roll spline into slot over screen wire to hold it tightly in place.

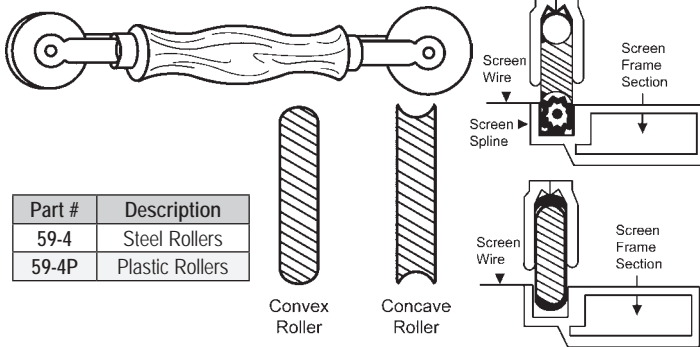

Part #	Description
59-4	Steel Rollers
59-4P	Plastic Rollers

Convex Roller

Concave Roller

### Screen Frame Notching Jig

**Easy to Use!**  
**A Real Time Saver!**

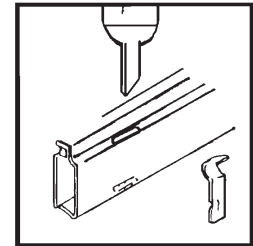
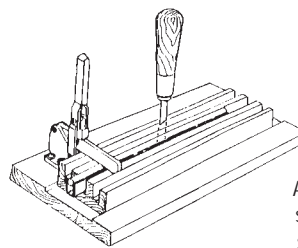

### 900-15853

The Screen Frame Notching Jig and Tool Assembly installs tension springs, slide locks, swivel and knife latches in aluminum window screen metal. The grooved wooden jig holds 5/16", 3/8" and 7/16" screen frame securely while you notch the metal with the notching tool.



### 900-15852

Notching Tool

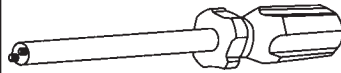

### 59-15

One-Way Screw Remover

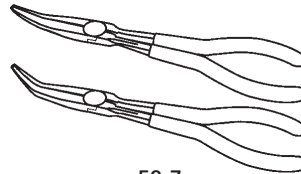

### 59-7

Long Reach Needle Pliers Set  
2 piece 11" 20° offset & 45° angle  
• Reach areas too tight for standard pliers  
• Made from drop-forged, heat-treated steel

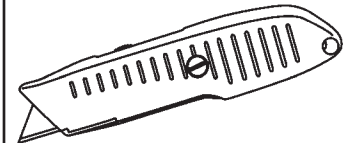

### 59-14

Utility Knife

- Professional Quality.
- Button Projects and Retracts Blade
- Sturdy Handle Provides Storage



### 59-23

6-in-1 Screwdriver.

Bits and tube are made of hardened steel. Lifetime Guarantee.



Phillips® #2  
1/4" Nut  
Driver

Phillips® #1

Slotted 9/32"

5/16" Nut  
Driver

Slotted 3/16"

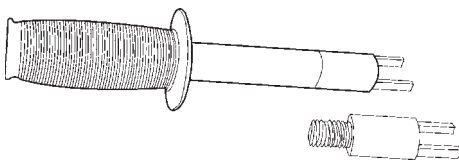

Part #	Fits	Tip Only
59-47	52-614 Roller Assy.	59-47T
59-47-1	52-613 and 52-675 Roller Assy.	59-47-1T
59-47-2	900-1285 Roller Assy.	59-47-2T

Roller Assembly Inserting Tool. Includes Tip.



Part #	Description
59-5	9.4 oz. Can
59-5-1	15 oz. Can

Alum-A-Lub Cleaner is the "All Purpose" lubricating cleaner that can be used on all products that stick or squeak. Alum-A-Lub assures ease of operation and a "Like New" appearance for metal windows, doors, locks, hinges, cabinets and more. Simply spray and wipe away dirt, grime and gummy residue left by other lubricants. A must for your shop, workroom, home, maintenance department or garage.  
**Sold individually and in cases of 12.**



Part #	Description
59-50	11 oz. Can
59-50-1	1 gal. Can

"L.C. Wax" Alumalick Aluminum Lubricant & Liquid Masking cleans and lubricates aluminum better than anything. Quick penetration/release and long lasting lubrication. Cleans corrosion and tarnish; protects from salt corrosion; reduces wear; stops squeaks, bumps, klunks, clinks.  
**Sold individually and in cases of 12.**

## PRECISION BEARING ROLLER ASSEMBLY FOR PATIO SLIDING GLASS DOOR

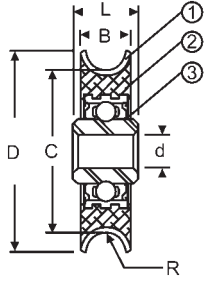

Part #	D	C	d	B	R	L
11-212	1-1/2"	1-1/4"	1/4"	5/16"	1/8"	3/8"
11-214	1-1/4"	1"	1/4"	5/16"	1/8"	3/8"

1. Outer Ring - Stainless Steel
2. Reinforced Nylon
3. Precision Bearing

### ABB Series Precision Bearing Stainless Steel Wheels

Completely new design that establishes a new level of quality for Patio Door Rollers. Design Highlights:

- Ideal for coastal applications
- Extremely smooth rolling
- Less operating force (motion to open/close)
- Less noise and vibrations
- Better corrosion resistance
- The Precision Bearing is factory greased and completely sealed
- The outer ring, that is the rolling surface of the wheel, is made of Stainless Steel to avoid any rust formation between the wheel and the track.
- Using composite nylon, the Precision Bearing is assembled with the outer ring by an injection molding process.

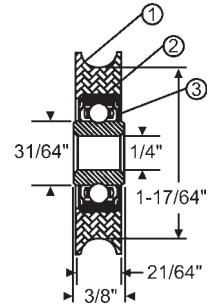

Part #	Wheel
11-227	1-1/2"
11-237	1-1/4"

1. Outer Ring - Nylon
2. Reinforced Nylon
3. Precision Bearing

### MBB Series Precision Bearing Nylon Wheels

This is an upgraded Nylon wheel that is assembled with a precision bearing as in the ABB Series. The Nylon tire is injected with fiber glass reinforced Nylon. The competitive advantages of this wheel are similar to those for the ABB Series,

- Extremely smooth rolling
- Less operating force (motion to open/close)
- Less noise and vibrations
- Higher Load capacity of 65 Lbs. per wheel (compared to 45 Lbs. per wheel on a regular Nylon wheel)
- The Precision Bearing is factory greased and completely sealed

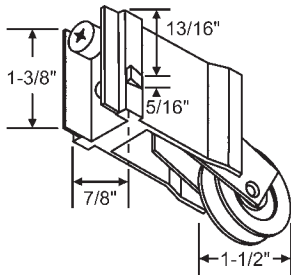

Part #	Size	Outer Ring
9-257SPB	1-1/2"	Stainless Steel
9-257NPB	1-1/2"	Nylon

### PAN AM

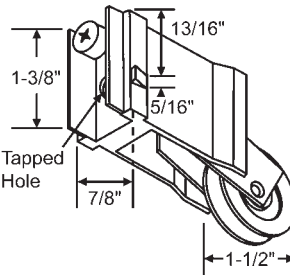

Part #	Size	Outer Ring
9-457SPB	1-1/2"	Stainless Steel
9-457NPB	1-1/2"	Nylon

### PAN AM/AAA

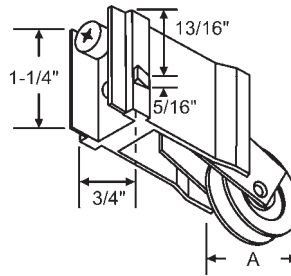

Part #	A	Outer Ring
9-247-1.25SPB	1-1/4"	Stainless Steel
9-247SPB	1-1/2"	Stainless Steel
9-247NPB	1-1/2"	Nylon

### YALE OGRON

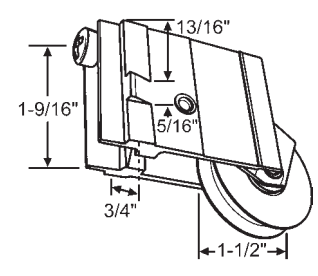

Part #	Size	Outer Ring
9-249SPB	1-1/2"	Stainless Steel
9-249NPB	1-1/2"	Nylon

### WEATHERTITE/LAWSON

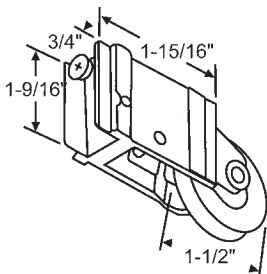

Part #	Size	Outer Ring
9-406SPB	1-1/2"	Stainless Steel
9-406NPB	1-1/2"	Nylon

### PGT

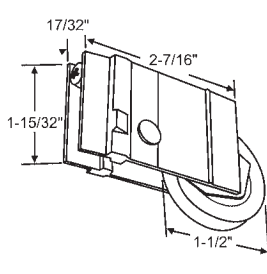

Part #	Size	Outer Ring
9-364SPB	1-1/2"	Stainless Steel
9-364NPB	1-1/2"	Nylon

Max. Width at Locking Tangs 31/32"  
**LAWSON/WALLACE**

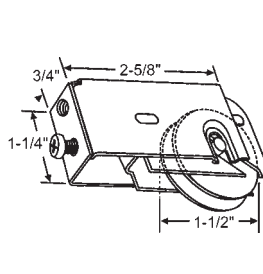

Part #	Size	Outer Ring
9-392SPB	1-1/2"	Stainless Steel

Max. Housing Thickness 3/4"

### CROFT

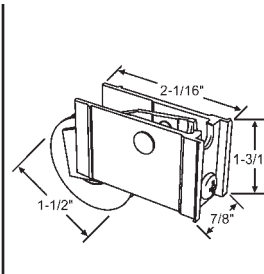

Part #	Size	Outer Ring
9-330SPB	1-1/2"	Stainless Steel

### SECURITY

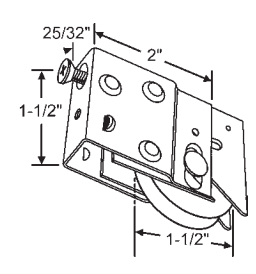

Part #	Size	Outer Ring
9-366SPB	1-1/2"	Stainless Steel

Max. Dimple Width 29/32"  
Max. Width at Locking Tangs 1"  
**BINNINGS/PAN AM**

# PATIO DOOR HARDWARE

## PRECISION BEARING ROLLER ASSEMBLY FOR PATIO SLIDING GLASS DOOR

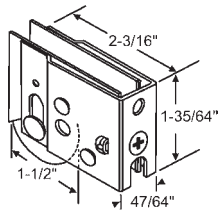

Part #	Size	Outer Ring
9-338SPB	1-1/2"	Stainless Steel

Maximum Width at Locking Tangs 7/8"

**HARCAR/KELLER/PAN AM**

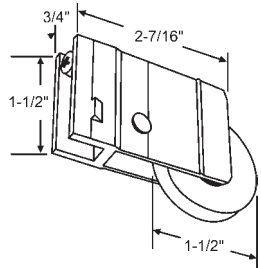

Part #	A	Outer Ring
9-453SPB	1-1/2"	Stainless Steel

**LAWSON**

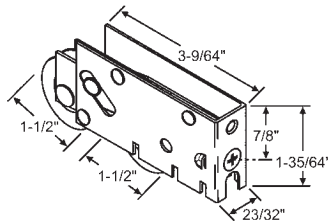

Part #	Size	Outer Ring
900-22693-SPB	1-1/2"	Stainless Steel
900-22693-NPB	1-1/2"	Nylon

**PGT/KINCO**

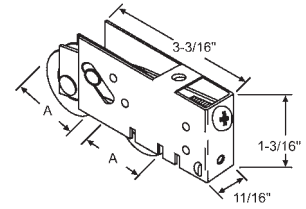

Part #	A	Outer Ring
9-443-1.25SPB	1-1/4"	Stainless Steel
9-443SPB	1-1/2"	Stainless Steel
9-443NPB	1-1/2"	Nylon

**NU-AIR**

### Your Roller Assembly Not Listed?

Call your sales representative and find out if we can furnish your particular patio door roller assembly with our Precision Bearing Roller. We have machine shop capabilities where we can supply many patio door roller assemblies equipped with our new Precision Bearing Roller.

## STAMPED GLASS DOOR ROLLER ASSEMBLIES

In Order by Wheel Diameter

**27/32"**

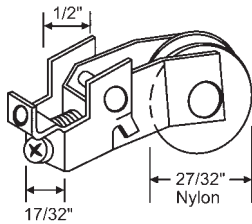

Part #	Wheel Type
9-291	Concave
9-291F	Flat

**USED BY TRACO**

**7/8"**

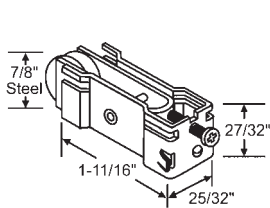

**9-295**

**ACORN**

**1"**

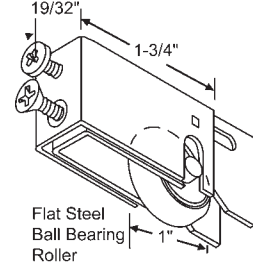

Flat Steel  
Ball Bearing  
Roller

**900-9469**

**CAPITOL/REMINGTON**

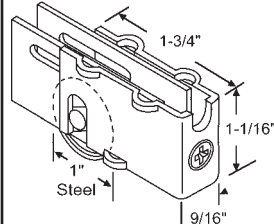

Part #	Wheel Type
9-305	Flat w/Tapered Edges
9-305SP	Concave

**CAPITOL**

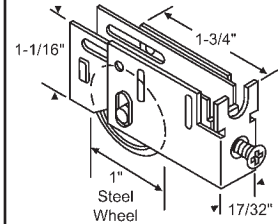

Part #	Wheel Type
900-10138	Flat
9-333	Concave

**CAPITOL/REMINGTON**

**1-1/16"**

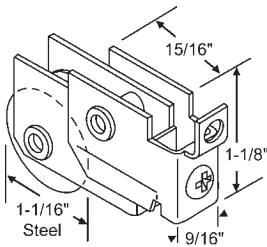

**9-306**

**CAPITOL/REMINGTON**

**1-1/8"**

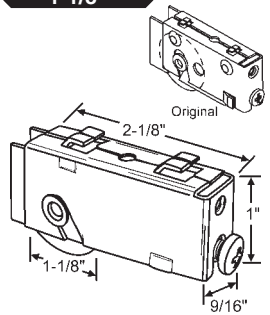

**9-218**

Max. Dimple Width 3/4"

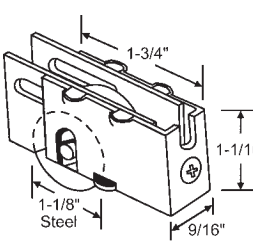

**9-273**

**REMINGTON**

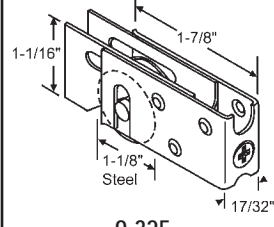

**9-325**

Max. Dimple Width 19/32" No  
Longer Available. Use: 900-14295C

**METAL INDUSTRIES/  
CAPITOL**

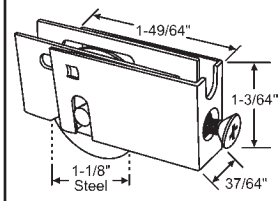

**900-14295C**

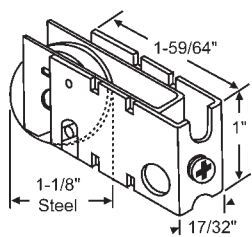

**900-16711**

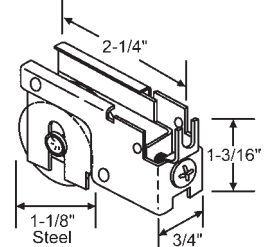

**9-289**

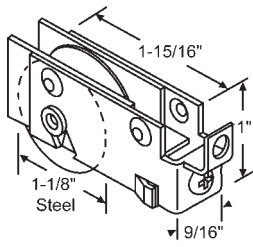

**9-324**

Max. Dimple Width 7/8"

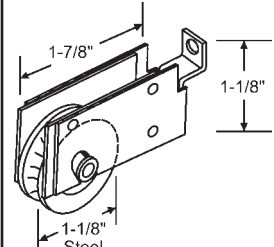

**9-293**

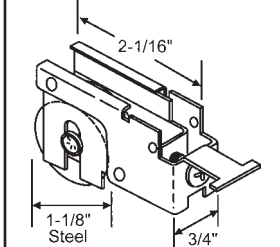

**9-292**

# PATIO DOOR HARDWARE

## STAMPED GLASS DOOR ROLLER ASSEMBLIES

In Order by Wheel Diameter

1-1/4"

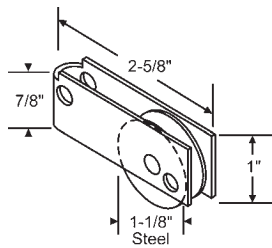

**9-279**  
Top Hole  
**CAPITOL**

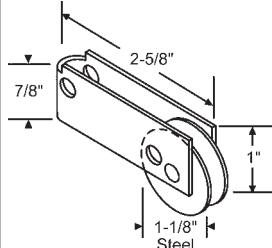

**9-279-1**  
Bottom Hole  
**CAPITOL**

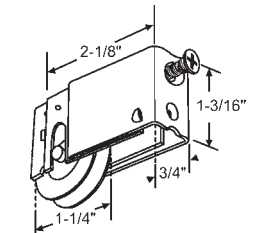

Part #	Wheel Type
900-10106	Steel
900-10106N	Nylon
900-10106SS	Stainless Steel

**NU-AIR**

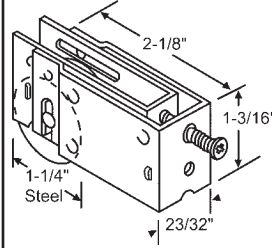

**900-15153**  
Dimple Width 3/4"  
Tang Width 7/8"

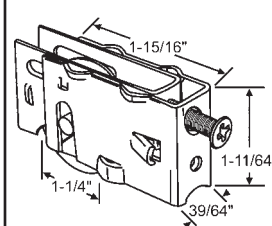

**900-10095**  
Max. Dimple Width 13/16"  
**BETTER-BILT**

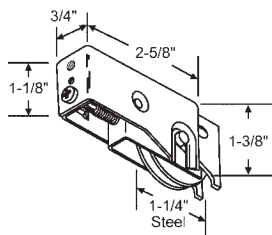

**9-238**

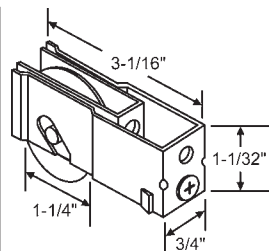

Part #	Wheel Type
9-258	Steel
9-258N	Nylon

**DARYL**

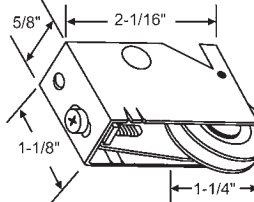

Part #	Wheel Type
9-245	Steel
9-245N	Nylon
9-245SS	Stainless Steel

**CROSSLY**

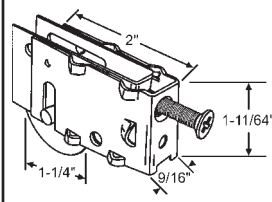

Part #	Wheel Type
900-7662	Steel
900-7662SS	Stainless Steel

Max. Dimple Width 3/4"  
**ACORN/ARUNDEL**

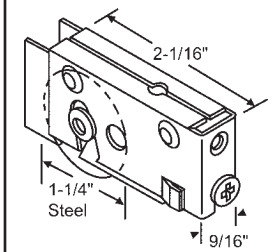

**900-13579**  
Max. Dimple Width 23/32"  
**ARUNDEL**

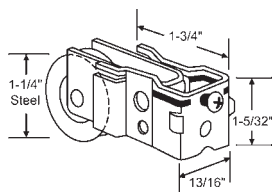

**9-215**  
**ACORN**

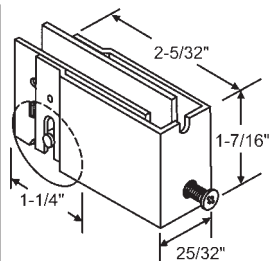

Part #	Wheel Type
9-331	Steel
9-331SS	Stainless Steel

**PENNCO**

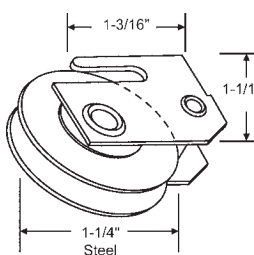

**9-209**

**ADOR HI-LITE**

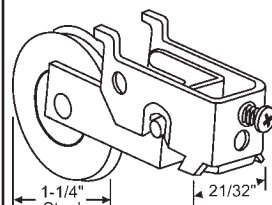

**9-209A**

**ADOR HI-LITE**

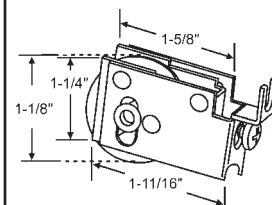

Part #	Wheel Type
900-13138	Steel

**LOOK**

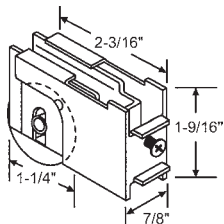

Part #	Wheel Type
9-266	Steel
9-266SS	Stainless Steel

**PEACHTREE**

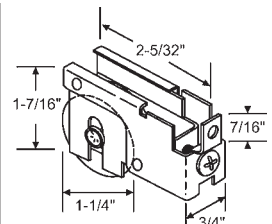

Part #	Wheel Type
9-200	Steel
9-200N	Nylon

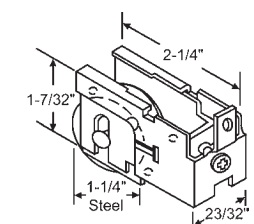

**9-299**

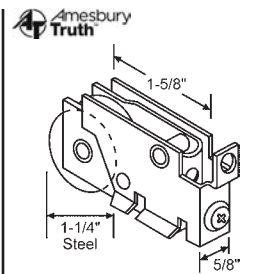

**9-286**

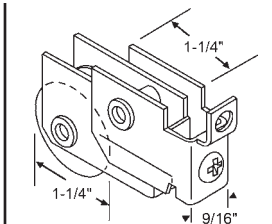

Part #	Wheel Type
9-216	Steel
9-216P	Nylon

# PATIO DOOR HARDWARE

## STAMPED GLASS DOOR ROLLER ASSEMBLIES

In Order by Wheel Diameter

1-1/4"

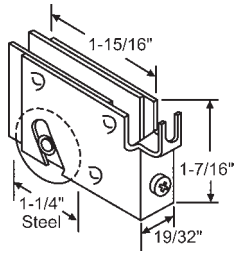

Part #	Wheel Type
9-294	Steel
9-294N	Nylon

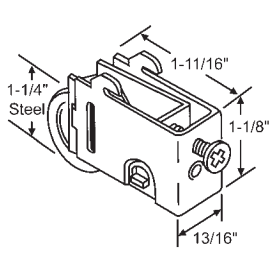

**900-10098A**

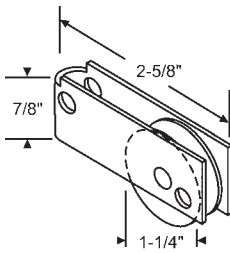

Part #	Wheel Type
9-262M	Steel
9-262	Nylon

Top Hole

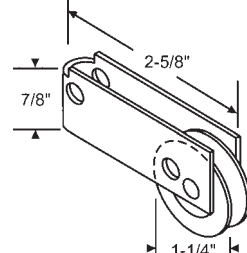

Part #	Wheel Type
9-263M	Steel
9-263	Nylon

Bottom Hole

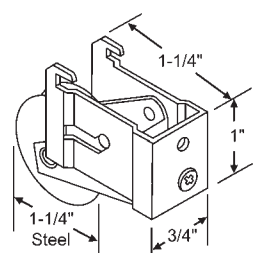

**900-9498**

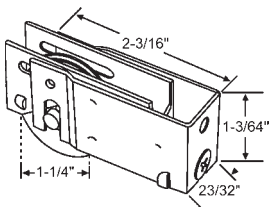

Part #	Wheel Type
900-18649	Steel
900-18649N	Nylon

Steel Body. 7/8" Tab Width

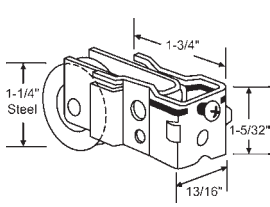

**9-215D**  
**ACORN**

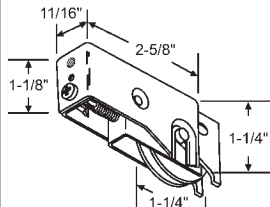

**9-318A**  
**JONES/DARYL**

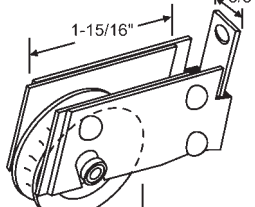

**9-219**  
**JONES/DARYL**

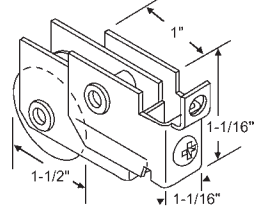

Part #	Wheel Type
9-217M	Steel
9-217P	Nylon

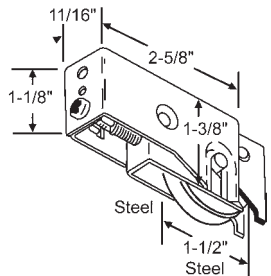

**9-341**

**LENAHAN/DARYL**

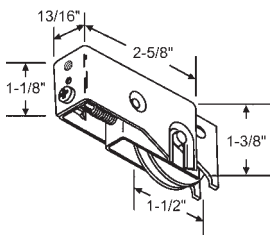

Part #	Wheel Type
9-260M	Steel
9-260	Nylon

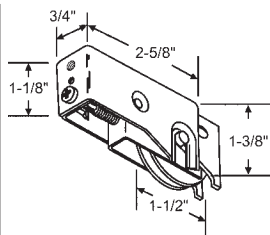

Part #	Wheel Type
9-261	Steel
9-261SS	Stainless Steel

**AIR CONTROL/KELLER**

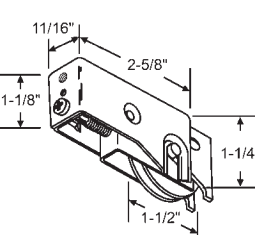

**9-318**

**JONES**

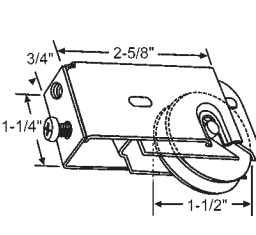

Part #	Wheel Type
9-392	Steel
9-392SS	Stainless Steel

Max. Housing Thickness 3/4"

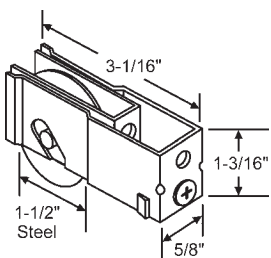

**9-250**

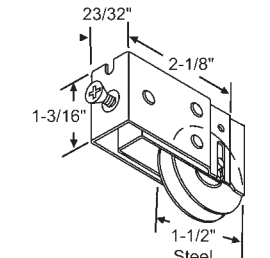

**900-10116**

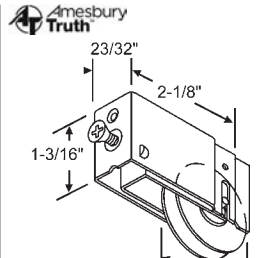

**900-10107**

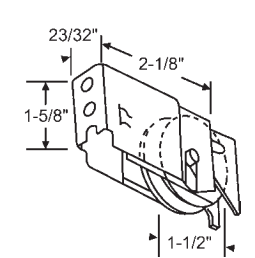

Part #	Wheel Type
9-304	Steel

Maximum Width at Locking Tangs  
57/64"

**KINCO/HARCAR**

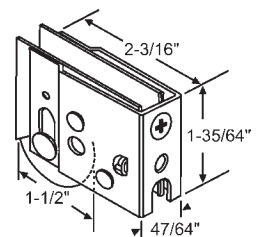

Part #	Wheel Type
900-11287	Steel
900-11287N	Nylon
900-11287SS	Stainless Steel

Maximum Width at  
Locking Tangs 7/8"  
**CROWN/LAWSON**



# PATIO DOOR HARDWARE

## STAMPED GLASS DOOR ROLLER ASSEMBLIES

In Order by Wheel Diameter

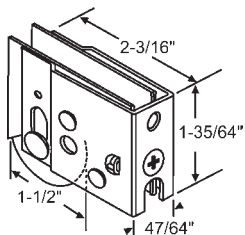

Part #	Wheel Type
9-338N	Nylon
9-338	Steel
9-338SS	Stainless Steel

Maximum Width at Locking Tangs 7/8"

**HARCAR**

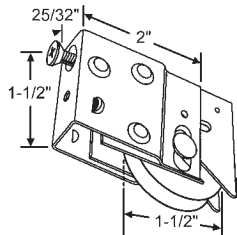

Part #	Wheel Type
9-366	Steel
9-366N	Nylon
9-366SS	Stainless Steel

Max. Dimple Width 29/32"

Max. Width at Locking Tangs 1"

**BINNINGS/PAN AM**

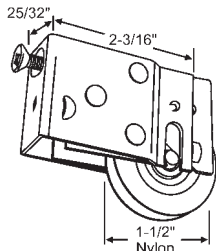

Part #	Wheel Type
9-327	Nylon
9-327S	Steel

Max Dimple Width 27/32"

Max Width at Locking Tangs 59/64"

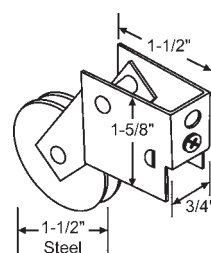

**9-235**

**KELLER**

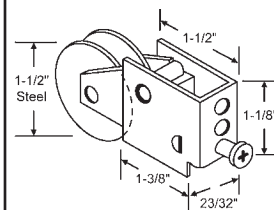

**9-211**

**HARCAR**

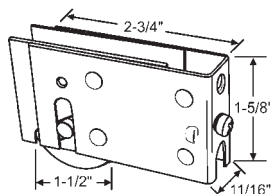

**9-377**

Dimple Width 7/8"

**CROWN INDUSTRIES**

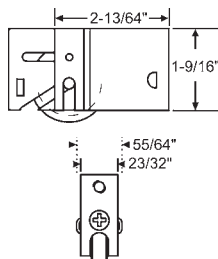

**9-512**

Steel Outer & Inner Housing with

1-1/2" Steel Wheel

**PGT**

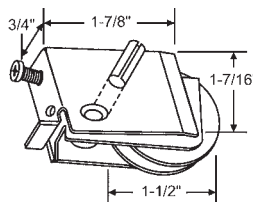

Part #	Wheel Type
9-255	Nylon
9-255M	Steel

**LUMIDOR**

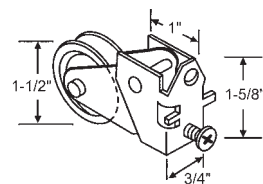

Part #	Wheel Type
9-233	Steel
9-233N	Nylon

**STANLEY**

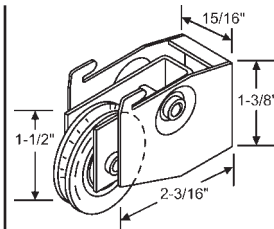

Part #	Wheel Type
9-220	Nylon
9-229	Steel

## DIE CAST ROLLER ASSEMBLIES

1-11/16"

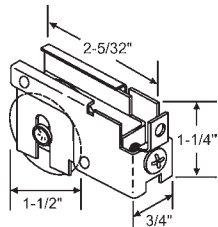

Part #	Wheel Type
9-201	Steel

Dimple Width 25/32"

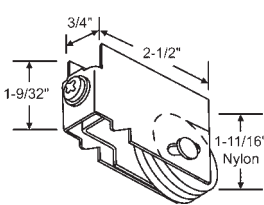

**9-207N**

**ARCADIA**

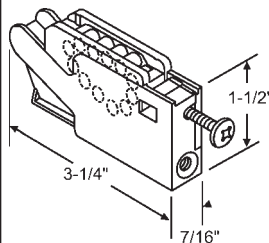

**9-335**

Nylon Caterpillar Rollers

**GREAT LAKES**

5/8"

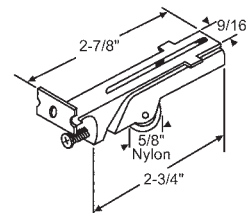

**9-202**

Flat Roller

7/8"

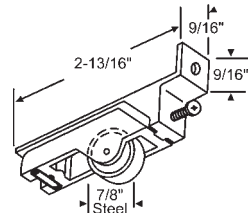

**9-277**

**ATLAS/PORTALUME**

1-1/4"

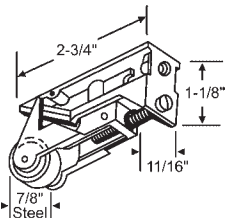

**9-303**

Flat Roller,

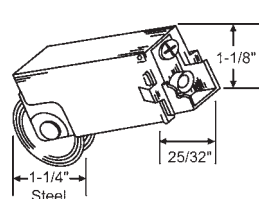

**9-214**

**BINNINGS**

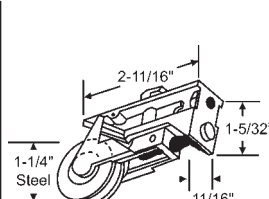

**9-276**

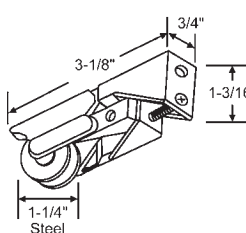

Part #	Wheel Type
9-248	Steel
9-248SS	Stainless Steel

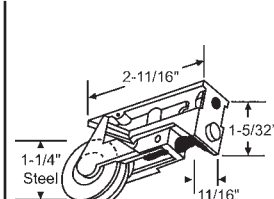

**9-275**

# PATIO DOOR HARDWARE

## DIE CAST ROLLER ASSEMBLIES

## EXTRUDED GLASS DOOR ROLLER ASSEMBLIES

In Order by Wheel Diameter

1-1/2"

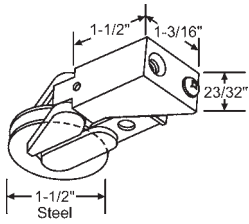

9-268

**KELLER/AIR CONTROL**

1-1/8"

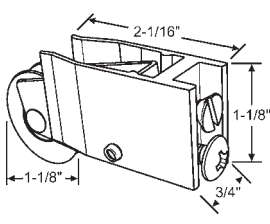

900-11663A

with Corner Housing and Screw.  
**SILVERLINE**

1-1/4"

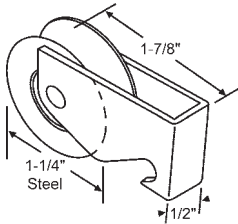

900-11663

**SILVERLINE**

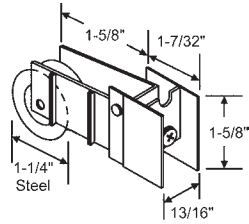

9-231

**PEACHTREE**

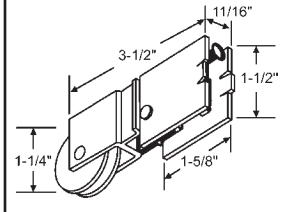

Part #	Wheel Type
9-205	Steel
9-205P	Nylon

**PEACHTREE**

1-5/16"

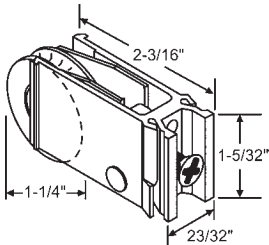

Part #	Wheel Type
9-252	Steel
9-252N	Nylon
9-252SS	Stainless Steel

**MILLER**

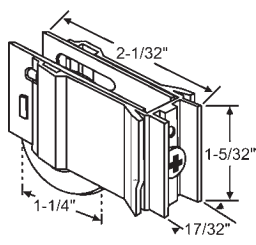

Part #	Wheel Type
9-371	Steel
9-371N	Nylon
9-371SS	Stainless Steel

**THERMALUME**

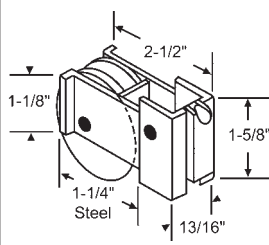

9-236

**PEACHTREE**

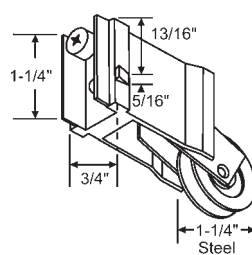

9-247-1.25S

**YALE**

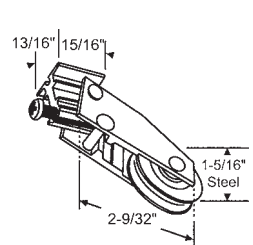

900-9582

**CROSSLY**

1-1/2"

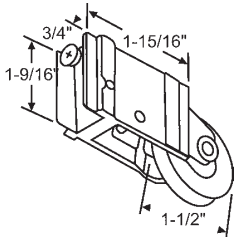

Part #	Wheel Type
9-406	Steel
9-406N	Nylon
9-406SS	Stainless Steel

**PGT**

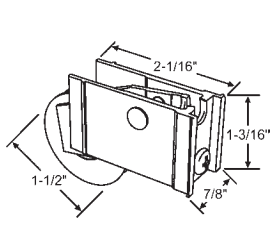

Part #	Wheel Type
9-330	Steel
9-330N	Nylon
9-330SS	Stainless Steel

**LAWSON**

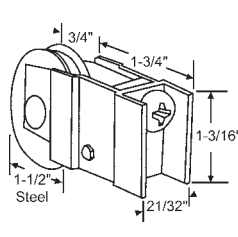

9-361

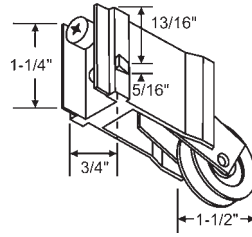

Part #	Wheel Type
9-247	Steel
9-247N	Nylon
9-247SS	Stainless Steel

**YALE**

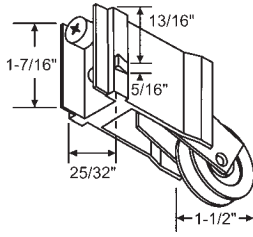

Part #	Wheel Type
9-237	Nylon
9-237S	Steel

**WALLACE**

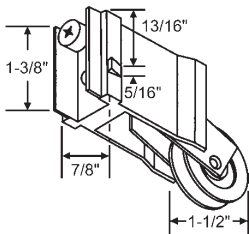

Part #	Wheel Type
9-257	Steel
9-257N	Nylon
9-257SS	Stainless Steel

**PAN AM**

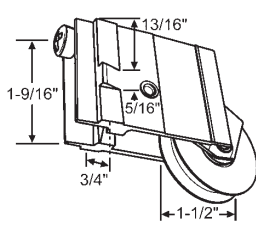

Part #	Wheel Type
9-249	Steel
9-249SS	Stainless Steel

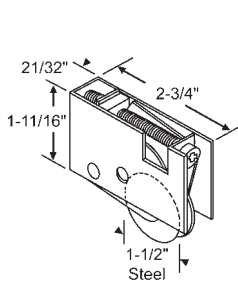

900-22072-OS

Old Style, Pre 1992. Fits Pella

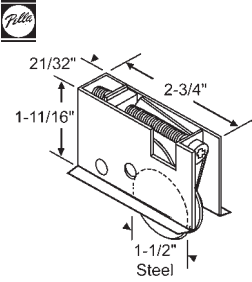

900-22072-NS

New Style

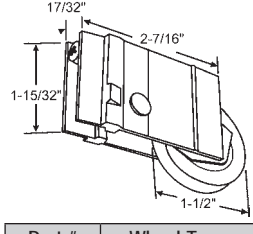

Part #	Wheel Type
9-364	Nylon
9-364S	Steel
9-364SS	Stainless Steel

Max. Width at Locking Tangs 31/32"

**LAWSON**

# PATIO DOOR HARDWARE

## EXTRUDED ROLLERS

In Order by Wheel Diameter

1-1/2"

1-21/32"

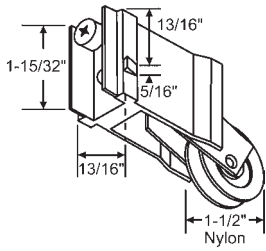

**9-240  
PLAMETRON**

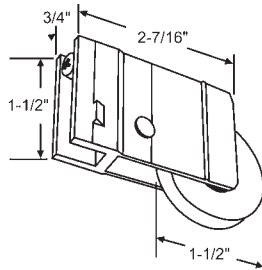

Part #	Wheel Type
9-453	Steel
9-453SS	Stainless Steel

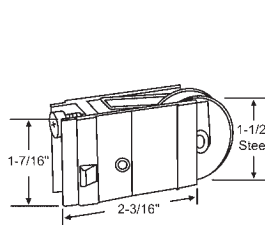

**9-370  
WALLACE/LAWSON**

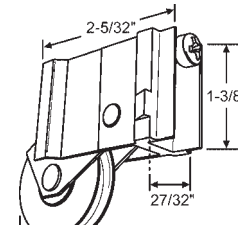

Part #	Wheel Type
9-457	Steel
9-457N	Nylon

Tab to Tab 1-1/2"

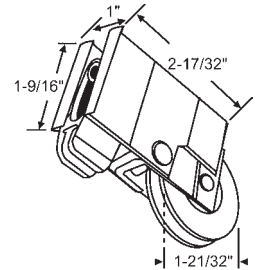

**900-22583  
ALCAN/NORANDEX**

1-11/16"

## TANDEM ROLLERS

In Order by Wheel Diameter

1"

1-1/8"

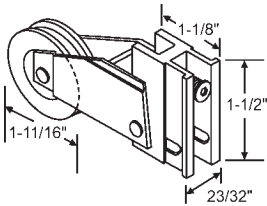

Part #	Wheel Type
9-254SS	Nylon Wheel with Stainless Steel Inner Race
9-254SS-M	Stainless Steel Ball Bearing Wheel

**DARYL/PLAZA**

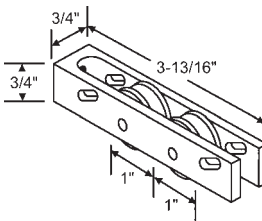

Part #	Wheel Type
9-267	Nylon
9-267S	Steel

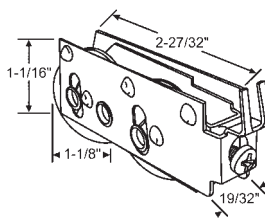

**900-9978**  
Steel Wheel. Dimple Width 3/4"  
**LOOK/RUSCO**

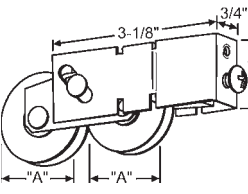

Part #	Wheel Type	A
9-405A	Steel	1-1/8"
	Stainless Steel	
9-405SS	(Housing, Wheels & Screw	1-1/8"
9-405	Steel	1"

**ACORN**

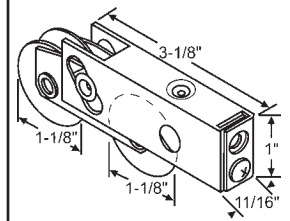

**900-19383SS-1 1/8**  
Stainless Steel 1-1/8" Wheels

1-1/4"

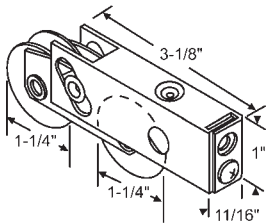

Part #	Wheel Type
900-19383	Steel
900-19383N	Nylon
900-19383SS	Stainless Steel

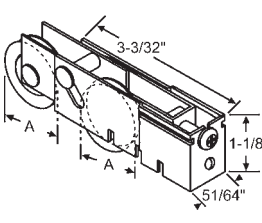

Part #	A	Wheel Type
900-19536	1-1/4"	Steel
900-19536A	1-1/8"	Steel
900-19536SS	1-1/4"	Stainless Steel

**WELLS 2000**

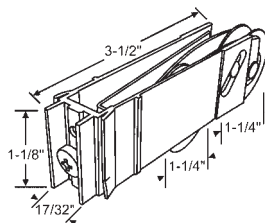

Part #	Wheel Type
9-368S	Steel
9-368SS	Stainless Steel

Max. Housing Width at Locking Tangs = 7/8". Inner Housing Stainless Steel  
**THERMALUME**

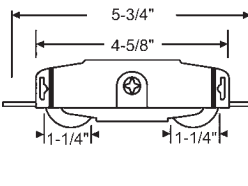

Part #	Wheel Type
9-239	Steel
9-312	Stainless Steel (Housing and Wheels)
9-317	"Flat" Nylon Rollers

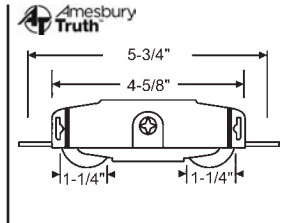

Part #	Wheel Type
9-239T	Steel
9-310T	Nylon
9-312T	Stainless Steel

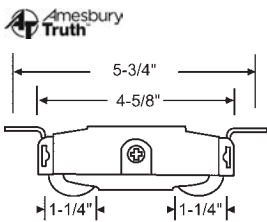

Part #	Wheel Type
9-313T	Steel
9-316T	Stainless Steel
9-346T	Nylon

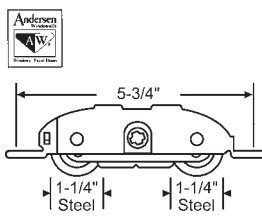

**750-1273704**  
No Longer Available.  
Use: 750-1997061

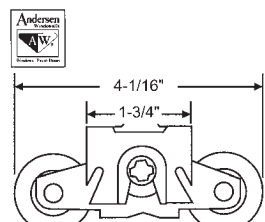

**750-1997061**

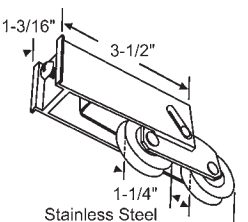

**9-367**  
Maximum housing width at flares  
1-3/16"

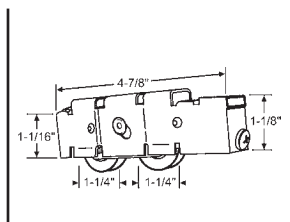

**9-449**  
Steel Housing with Nylon Ball  
Bearing Wheel  
**PH TECH/AMERIMAX**

# PATIO DOOR HARDWARE

## TANDEM ROLLERS

In Order by Wheel Diameter

1-1/4"

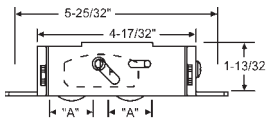

Part #	Wheel Type	A
9-397N	Nylon	1-1/4"
9-397	Steel	1-1/4"
9-397SS	Stainless Steel	1-1/4"
9-441	Steel	1-1/2"

1-1/2"

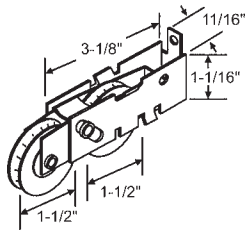

Part #	Wheel Type
9-234	Steel

**FLEETWOOD**

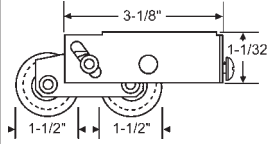

Part #	Wheel Type
900-22358	Steel
900-22358SS	Stainless Steel

Top Hole Mounting

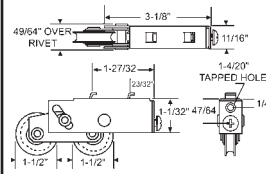

Part #	Wheel Type
900-22357	Steel

Hook Mounting

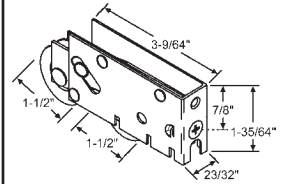

Part #	Wheel Type
900-22693	Steel
900-22693N	Nylon
900-22693SS	Stainless Steel

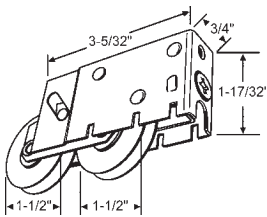

Part #	Wheel Type
9-375	Steel
9-375SS	Stainless Steel

**GUARANTEED PRODUCTS/  
JORDAN COMPANY**

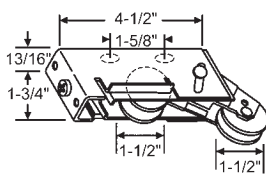

Part #	Wheel Type
9-280	Steel
9-280SS	Stainless Steel

Max. Housing Width 1-7/32"  
**ARCADIA/KAWNEER**

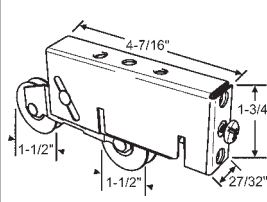

**9-473SS**  
Stainless Steel Wheels  
**PGT**

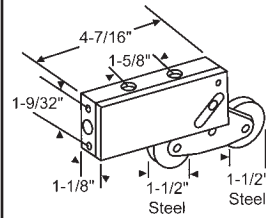

**900-12198**  
**KAWNEER**

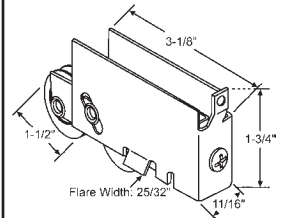

**9-507SS**  
Stainless Steel  
**FLEETWOOD**

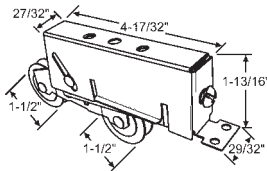

**9-280MT-SS**  
Stainless Steel  
**ARCADIA**

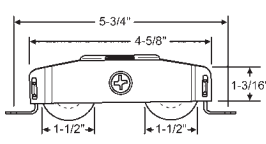

Part #	Wheel Type
9-448	Steel
9-448SS	Stainless Steel

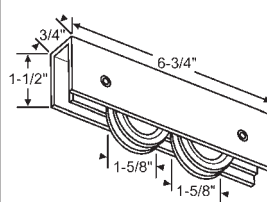

Part #	Wheel Type
9-456	Black Nylon
9-456NB	Nylon Ball Bearing

**TM PRODUCTS**

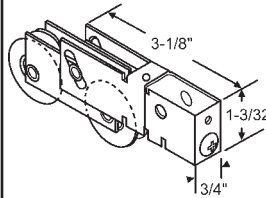

Part #	Wheel Type	Wheel Size
9-403A	Steel	1-1/8"
9-403B	Steel	1-1/4"
9-403	Steel	1-1/2"
9-403AN	Nylon	1-1/8"
9-403BN	Nylon	1-1/4"
9-403N	Nylon	1-1/2"
9-403ASS	Stainless Steel	1-1/8"
9-403BSS	Stainless Steel	1-1/4"
9-403SS	Stainless Steel	1-1/2"

Maximum Housing Width 3/4"

## SCREEN DOOR ROLLER ASSEMBLIES

1-11/16"

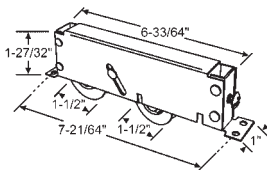

**9-474SS**  
Stainless Steel  
**PGT/ KAWNEER**

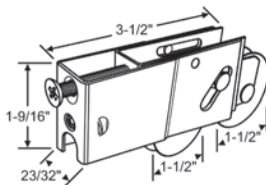

Part #	Wheel Type
9-454	Steel
9-454SS	Stainless Steel

Housing Matches Wheel  
**PGT**

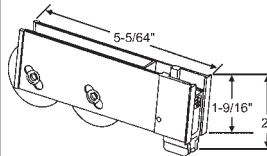

**9-378**  
1-11/16" Nylon Wheels w/  
Stainless Steel Ball Bearings. 1"  
Width Aluminum Outer Housing  
Stainless Steel Inner Housing  
**ALCAN/ NORANDEX**

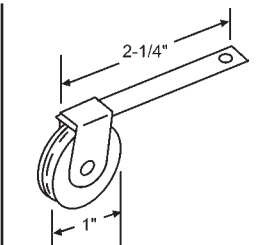

Part #	Wheel Type
10-356	Nylon
10-392	Steel

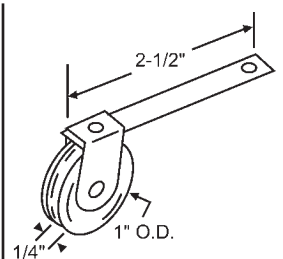

**10-436**  
Nylon Wheel

# PATIO DOOR HARDWARE

## SCREEN DOOR ROLLER ASSEMBLIES

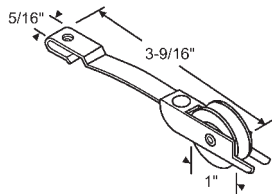

Part #	Wheel Type
10-407	Nylon
10-407M	Steel

**COLUMBIA**

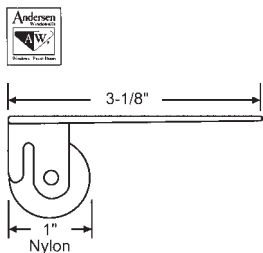

**750-1274004**

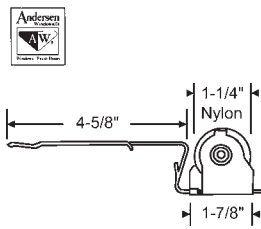

**750-1997063**  
Upper

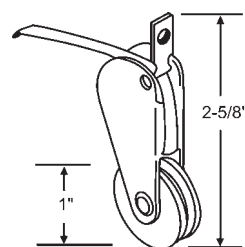

Part #	Wheel Type
10-312	Nylon
10-372	Steel

**METAL INDUSTRIES**

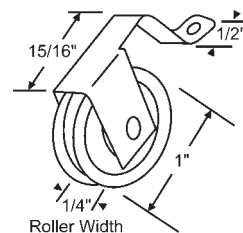

Part #	Wheel Type
10-396	Nylon
10-396M	Steel

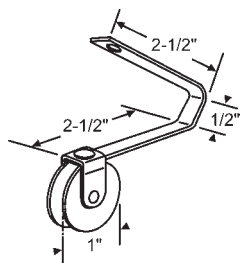

**10-388**  
Nylon

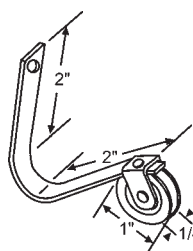

Part #	Wheel Type
10-359	Nylon
10-359M	Steel

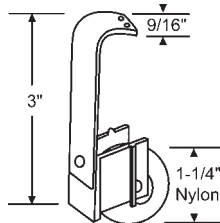

**10-353**

**PEACHTREE**

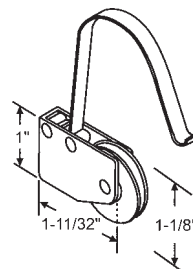

**10-414**  
1-1/8" Dia. Steel Ball Bearing  
Wheel. Used with Corner 16-301

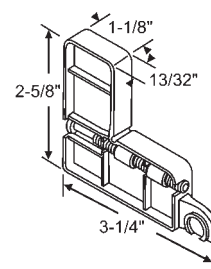

**16-301**  
Corner for 10-414

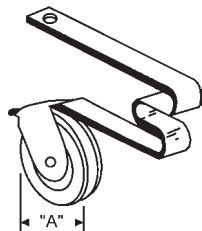

Part #	"A"	Wheel Type
10-358	7/8"	Nylon
10-371	1"	Steel

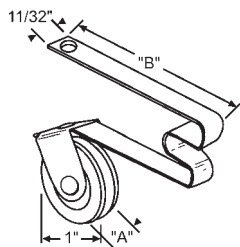

Part #	"A"	"B"	Wheel Groove
10-314	17/64"	2-1/2"	
10-314R	15/64"	2-5/16"	

Nylon Wheel

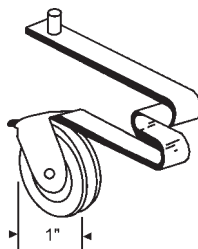

Part #	Wheel Type
10-306	Nylon
10-306M	Steel

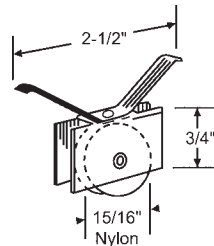

**10-300**  
**KELLER**

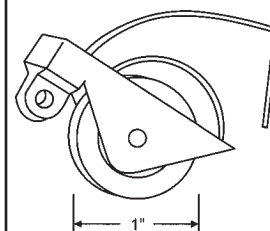

Part #	Wheel Type
10-348	Nylon
10-348M	Steel

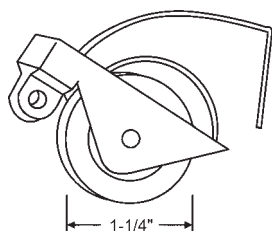

Part #	Wheel Type
10-360	Nylon
10-360M	Steel

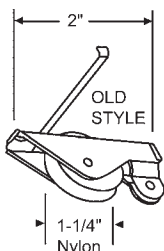

**10-368**  
**ACORN**

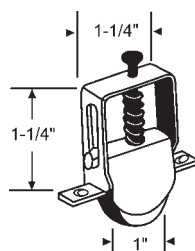

Part #	Wheel Type
10-343	Nylon
10-343M	Steel

Mounting Holes 1-11/16"  
**COLUMBIA**

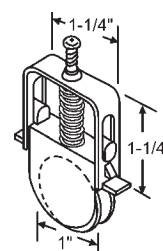

Part #	Wheel Type
10-403	Nylon
10-403M	Steel

**COLUMBIA**

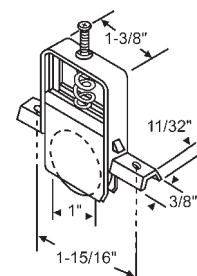

**10-404**  
Nylon  
**COLUMBIA**

# PATIO DOOR HARDWARE

## SCREEN DOOR ROLLER ASSEMBLIES

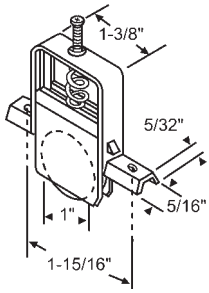

Part #	Wheel Type
10-406	Nylon
10-406M	Steel

**COLUMBIA**

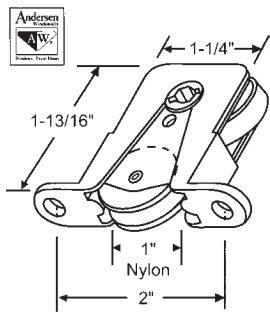

**750-1274104**

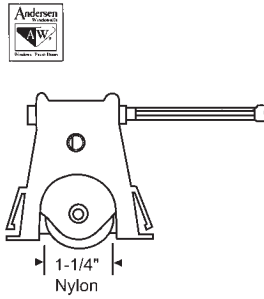

**750-1997310**  
Lower

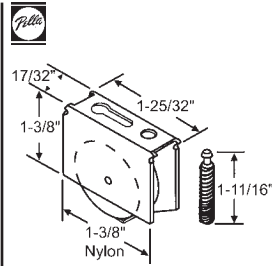

**900-10862**

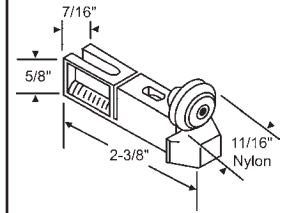

**10-365**

**ADOR HI-LITE**

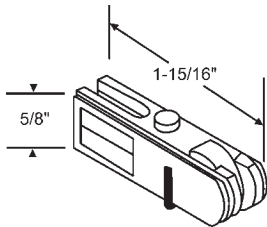

**10-326**

**ADOR HI-LITE**

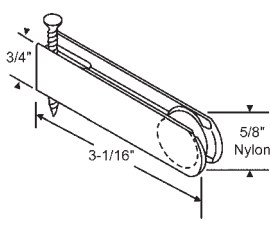

**10-401**

**WEATHER SHIELD**

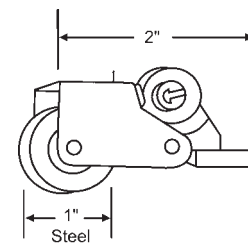

Part #	Hand
900-12879LH	LH (shown)
900-12879RH	RH

Adjustable Roller  
**BITESCREEN**

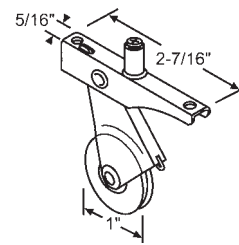

Part #	Wheel Type
10-410	Steel
10-410P	Nylon
10-410SS	Stainless Steel

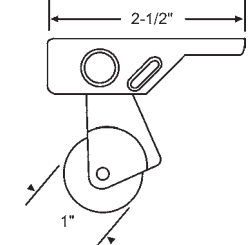

Part #	Wheel Type
900-20072	Nylon
900-20072S	Steel

**BITESCREEN/METAL INDUSTRIES**

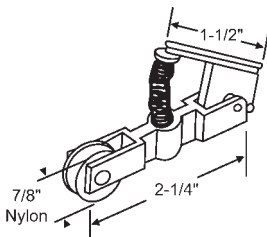

**10-302**

**CHRYSLER**

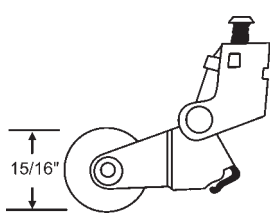

Part #	Wheel Type
10-367	Nylon
10-367M	Steel

**JIM WALTERS**

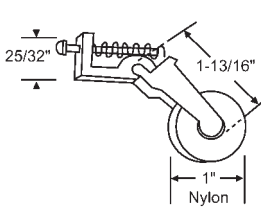

Part #	Wheel Type
900-9705	Nylon
900-9705S	Steel
900-9705SS	Stainless Steel

**YALE-OGRON**

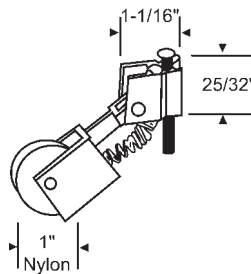

**10-313**

**MILLER**

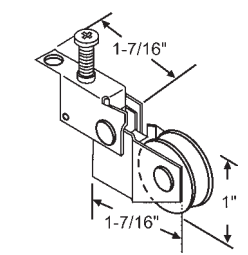

Part #	Wheel Type
900-19216	Nylon
900-19216M	Steel

**MOSS**

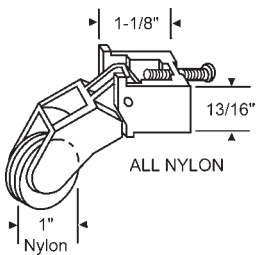

**10-394**

**PEACHTREE**

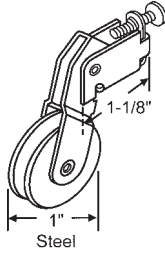

**10-394M**

**PEACHTREE**

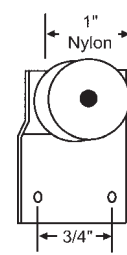

**900-14766**

Top Hung. Use with 10-395  
**WEATHER-BARR**

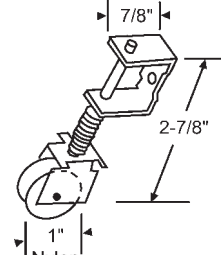

**10-351**

**CROSSLY**

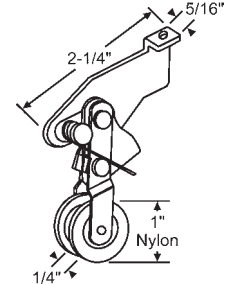

**10-395**

Use with 900-14766  
**WEATHER-BARR**

# PATIO DOOR HARDWARE

## SCREEN DOOR ROLLER ASSEMBLIES



**900-17614**

Adjustment Sleeve for 10-395



**900-17615**

Adjustment Screw for 10-395

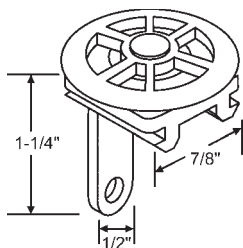

**900-9068**  
**PEACHTREE**

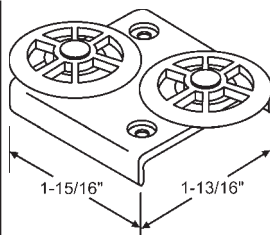

**900-14226**  
**PEACHTREE**

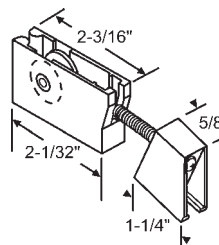

**10-417**  
Old Style  
**BALTIMORE THERMAL**

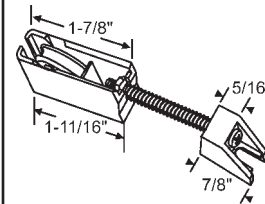

**10-417NS**  
**BALTIMORE THERMAL**

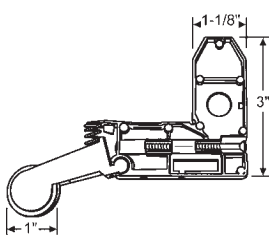

Part #	Wheel Type
10-457	Nylon
10-457SS	Stainless Steel

**FLORIDA SCREEN**

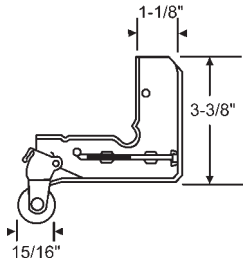

Part #	Wheel Type
10-373	Nylon
10-373M	Steel

Maximum Corner Thickness 7/16"  
**JIM WALTERS**

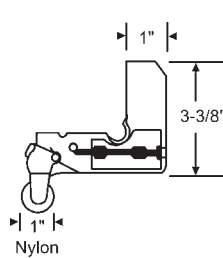

**10-399**  
Maximum Corner Thickness  
13/32"  
**ACORN**

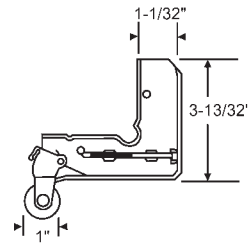

Part #	Description	Corner Thickness
10-398	Nylon for Steel Doors	15/32"
10-398A	Nylon for Aluminum Doors	7/16"
10-398S	Steel for Steel Doors	15/32"
10-398AS	Steel for Aluminum Doors	7/16"

**RITESCREEN**

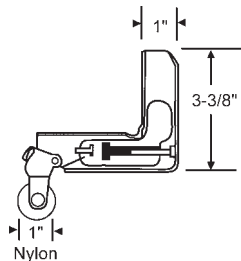

**10-355**  
Maximum Corner Thickness  
11/32"  
**JIM WALTERS**

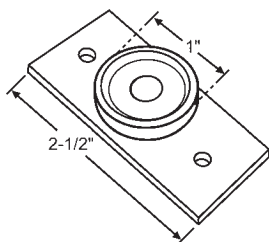

**10-460**  
Top Roller. 1" Nylon Wheel  
**TM PRODUCTS**

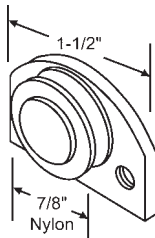

**10-301**

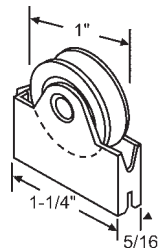

Part #	Wheel Type
10-408	Nylon
10-408M	Steel

Part of 10-402LH/RH  
**COLUMBIA**

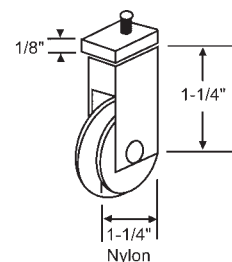

**10-318**  
Nylon

### TRACK AND ROLLER ASSEMBLY

### NYLON WHEELS

In Order by Wheel Diameter

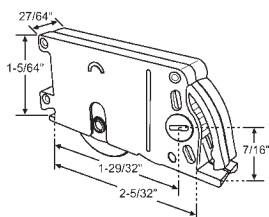

**10-443**  
1" Metal Wheel. Adjustable  
Vertical Roller 15/64" thru 7/8"  
Highest Position  
**NORCO**

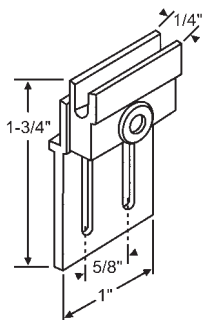

**10-455**  
Aluminum Bracket w/Nylon Guide  
**CROFT**

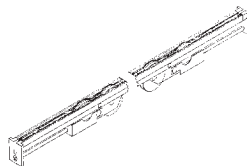

Part #	Description
900-15116	for 34" Glass 38-1/2"
900-15117	for 46" Glass 50"

Assembly has Four 1-1/8" Steel Adjustable Rollers-

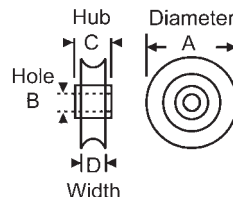

Part #	A	B	C	D
11-129	5/8"	5/32"	3/16"	3/16"

Nylon with Axle

# PATIO DOOR HARDWARE

## NYLON WHEELS

In Order by Wheel Diameter



Part #	A	B	C	D
11-115	5/8"	3/16"	1/4"	3/16"

Nylon

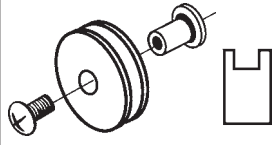

Part #	A	B	C	D
11-112	1-5/64"	1/4"	1/4"	1/4"

Nylon with Post and Screw  
**AIR CONTROL**

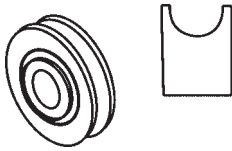

Part #	A	B	C	D
11-120	1-1/4"	1/4"	11/32"	5/16"

Nylon with Ball Bearing Steel Hub

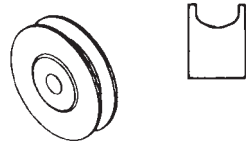

Part #	A	B	C	D
11-122	1-31/64"	1/4"	11/32"	19/64"

Nylon with Ball Bearing Steel Hub



Part #	A	B	C	D
11-110	1-11/16"	1/4"	29/64"	13/32"

Nylon with Steel Ball Bearing Hub

## STEEL WHEELS

In Order by Wheel Diameter

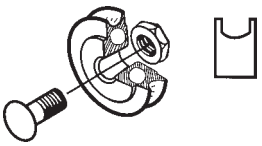

Part #	A	B	C	D
11-130	1"	1/4"	3/8"	5/16"

Steel with Steel Ball Bearing Hub,  
Nut & Bolt.

**11-130X for Roller Only**

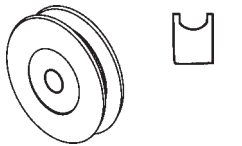

Part #	A	B	C	D
900-9576	1-1/8"	1/4"	3/8"	5/16"

Steel with Ball Bearing Hub

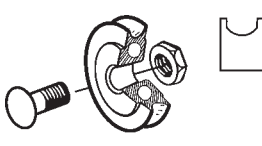

Part #	A	B	C	D
11-116	1-1/4"	1/4"	11/32"	5/16"

Steel with Steel Ball Bearing Hub  
Nut & Bolt.

**11-116X for Roller Only**



Part #	A	B	C	D
11-139	1-1/4"	1/4"	51/64"	5/16"

Steel with Steel Ball Bearing Hub

**ACORN**

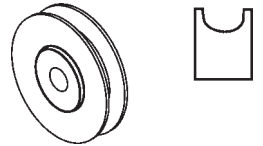

Part #	A	B	C	D
11-111	1-15/32"	1/4"	11/32"	5/16"

Steel with Steel Ball Bearing Hub

Part #	A	B	C	D
11-111SS	1-15/32"	1/4"	11/32"	5/16"

All Stainless Steel

## SLIDING GLASS & SCREEN DOOR KEEPERS

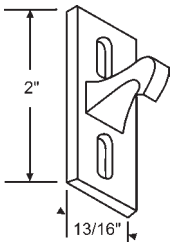

**12-251**

Chrome Plated  
**MILLER**

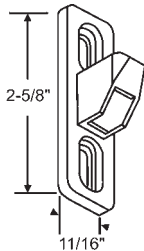

Part #	Finish
12-214	Chrome
12-214B	Black

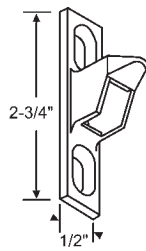

**12-211**

Chrome Plated  
Narrow

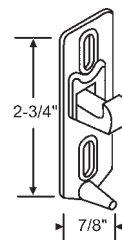

**12-205**

Chrome Plated  
**CROSSLY**

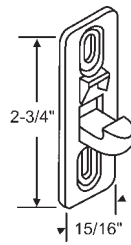

**12-216**

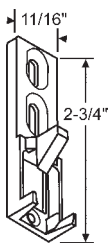

**900-9332**

**QUAKER**

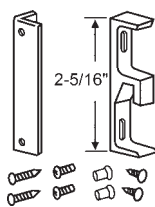

Part #	Finish
12-237	Aluminum
12-237B	Black

Universal Strike Kit

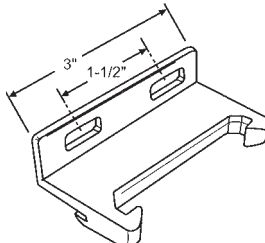

**900-69**

Mill Finish  
**YALE-OGRON**

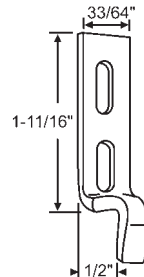

**12-304**

Metal  
**WRIGHT PRODUCTS**

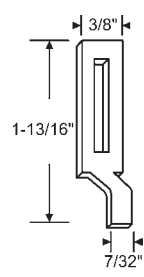

**12-206**

Metal  
**RITE SCREEN**



# PATIO DOOR HARDWARE

## SLIDING GLASS & SCREEN DOOR KEEPERS

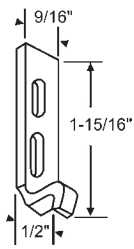

**12-248**  
Metal  
**ACORN**

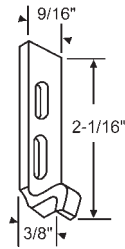

**12-240**  
Steel  
**WRIGHT PRODUCTS**

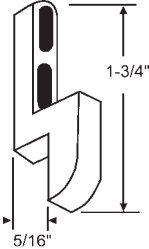

**12-212**  
Mill Finish  
**RITE SCREEN**

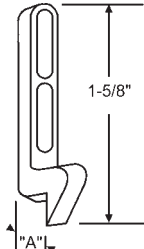

Part #	"A"
12-207	11/16"
12-226	3/16"
12-255	5/16"
12-230	15/32"

Mill Finish

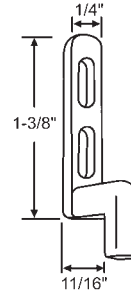

**12-287**  
**BAYFORM**

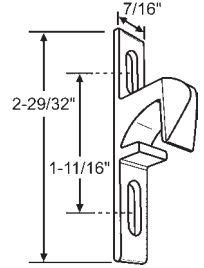

**12-306**  
Aluminum  
**TM**

## FLUSH MOUNT HANDLES FOR PATIO DOORS

In Order by Hole Spacing

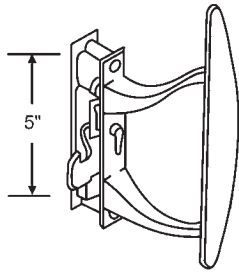

Part #	Hand	Finish
13-171	Shown	Aluminum
13-172	Opposite	Aluminum

**TUCKER**

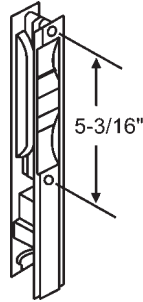

**13-177**  
**DARYL**

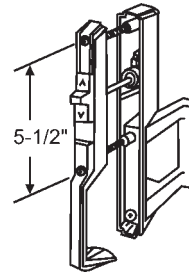

Part #	Finish
13-275	Black
13-275W	White
13-275AB	Antique Brass

**ARIEL- PEACHTREE**

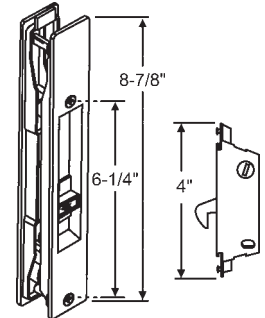

**13-391**  
**ADAMS RITE**

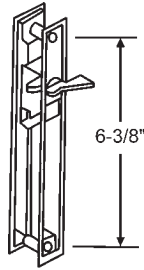

**13-175**  
Less Key Lock  
**MILLER**

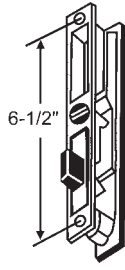

**13-100**  
Handle Set Less Key Lock  
Chrome Plated  
For Optional Pull Handle Use 13-108  
**CROSSLY**

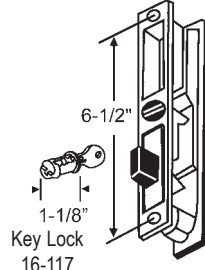

**13-107**  
Handle Set with Key Lock  
Chrome Plated  
For Optional Pull Handle Use 13-108  
**CROSSLY**

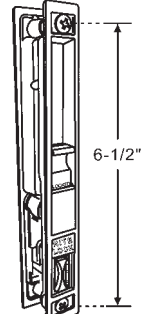

**900-7559**  
Black  
No Longer Available.  
Use: 13-140B or 13-192B

### Fit-All Flush Mount Handle Set with Nite Lock

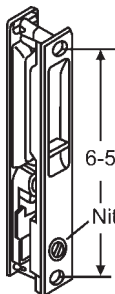

Both Handle Sets Include: Each of 5 Cam Sizes (S,C,P,X,K), 2 Screws and Keeper

Handle Set without Key Cylinder

Part #	Finish
13-140	Chrome
13-140B	Black
13-140W	White

Handle Set with Key Cylinder

Part #	Finish
13-140K	Chrome
13-140BK	Black
13-140WK	White

### Fit-All Flush Mount Handle Set without Nite Lock

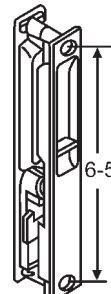

Both Handle Sets Include: Each of 5 Cam Sizes (S,C,P,X,K), 2 Screws and Keeper

Handle Set without Key Cylinder

Part #	Finish
13-192	Chrome
13-192B	Black
13-192W	White

Handle Set with Key Cylinder

Part #	Finish
13-192K	Chrome
13-192BK	Black
13-192WK	White

# PATIO DOOR HARDWARE

## FLUSH MOUNT HANDLES FOR PATIO DOORS

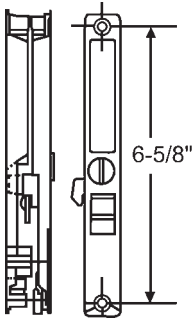

Part #	Finish
13-292	Chrome Plated
13-292W	White

With Nite Lock, "C" Cam and Keeper  
**PAN AM/NU AIRE**

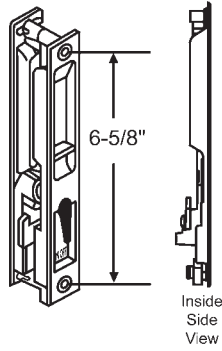

Part #	Finish
900-21019	Black
900-21019C	Chrome
900-21019W	White

With Nite Lock, "S" Cam and Keeper

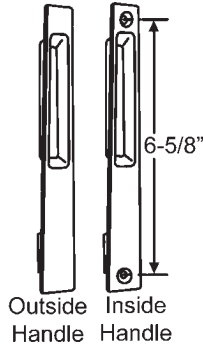

**13-311**  
Flush mount dummy set. Chrome

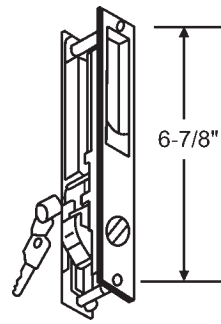

Part #	Description
13-178	w/Key Lock
13-178X	No Key Lock

**DARYL**

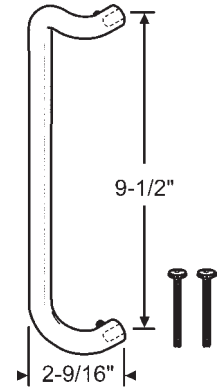

**13-531W**  
White. 1" Offset. Handle for #900-17543W  
**TM PRODUCTS**

## HANDLES FOR PATIO DOORS

In Order by Hole Spacing

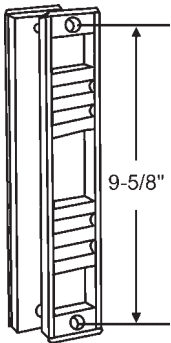

Part #	Finish
900-17543	Black
900-17543W	White

**TM PRODUCTS**

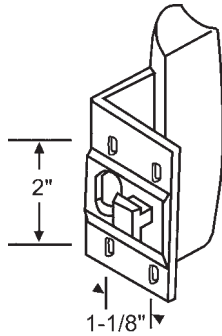

**13-191**  
Black. Used with Lock Bar 16-188 and 16-230  
**CAPITOL**

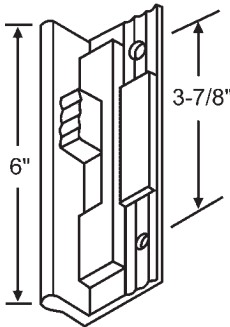

**900-49**  
Interior Handle  
Aluminum Finish

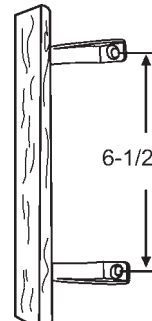

Part #	Finish
13-259	Chrome with Wood Handle
13-259B	Black with Wood Handle

Solid One Piece Bracket

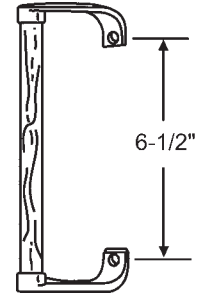

**13-108B**  
Wood with Black Brackets  
**CROSSLY**

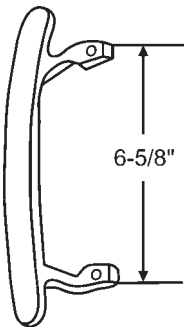

Part #	Finish
13-105	Chrome
13-105B	Black
13-105W	White

Die Cast

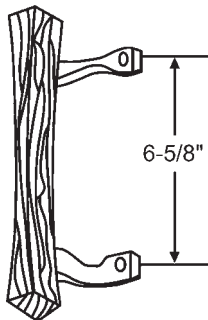

Part #	Finish
13-109	Chrome with Wood Handle
13-109B	Black with Wood Handle
13-109W	White with Wood Handle

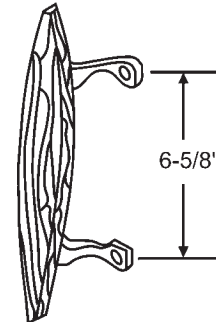

Part #	Finish
13-115	Chrome with Wood Handle
13-115B	Black with Wood Handle

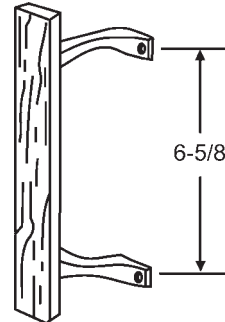

Part #	Finish
13-232	Chrome with Wood Handle
13-232B	Black with Wood Handle

Heavy Duty Brackets  
**CAPITOL**

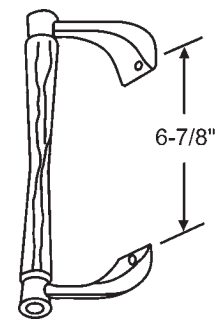

**900-9**  
Walnut Handle with Brackets  
**DARYL**

# PATIO DOOR HARDWARE

## HANDLES FOR PATIO DOORS

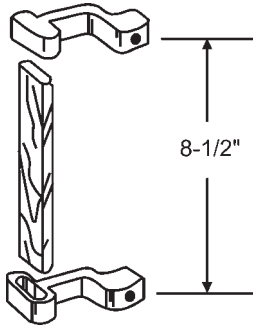

**13-190B**

Wood with Black Brackets  
Use with 13-100 and 13-107  
**CAPITOL**

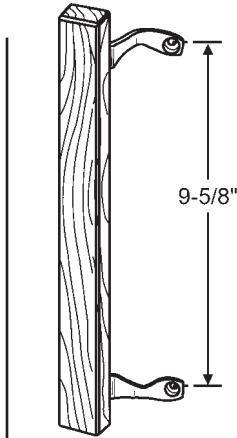

**900-17542**

Wood Handle w/ Chrome Bracket  
2 Screws Included  
**TM PRODUCTS**

## HANDLE BRACKETS

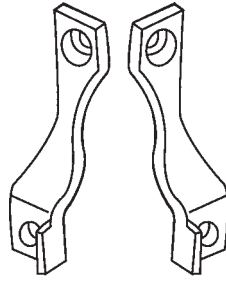

Part #	Finish
16-125	Black
16-123	Chrome

Handle Brackets Sold in Pairs  
Used with 13-109, 13-115

## HANDLE SCREWS



Part #	Length	Color
20-005	7/8"	Chrome
20-006	1"	Chrome
20-006B	1"	Black
20-006W	1"	White
20-007	1-1/8"	Chrome

10-32 Chrome Plated  
Oval Head Screw

## HANDLE SETS FOR PATIO DOORS

In Order by Style  
and Hole Spacing

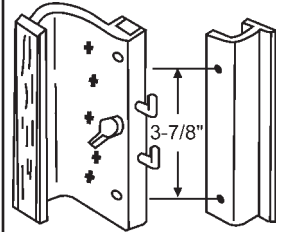

Part #	Finish
13-153	Aluminum
13-153B	Black

**ADOR HI-LITE**

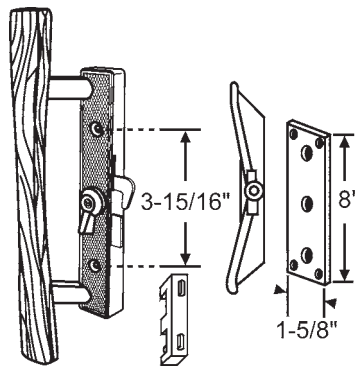

Handle Set with Plate

Part #	Finish
13-112	Aluminum with Wood Handle

Handle Set without Plate

Part #	Finish
13-112X	Aluminum with Wood Handle

Handle Set with Plate  
and 16-126 Key

Part #	Finish
13-113	Aluminum with Wood Handle

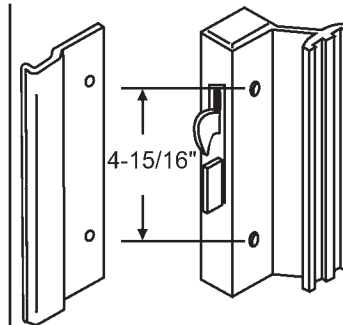

Part #	Finish
13-152	Aluminum
13-152B	Black

Includes Fit-All Keeper Assy., Screws and  
Black Outside Pull

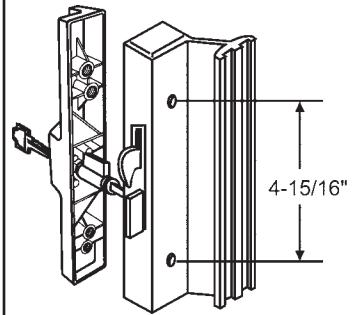

Part #	Finish
13-152K	Aluminum
13-152BK	Black

Includes Fit-All Keeper Assy., Screws and  
Black Outside Pull with Key Cylinder

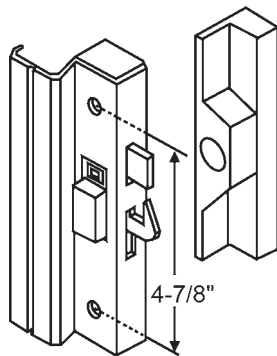

**13-255**

Black  
**PEACHTREE/CITATION**

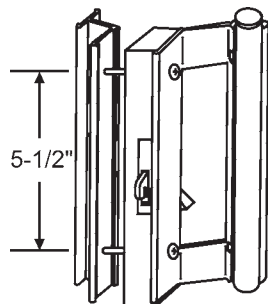

**13-160**

New Style  
Aluminum Finish  
**PEACHTREE**

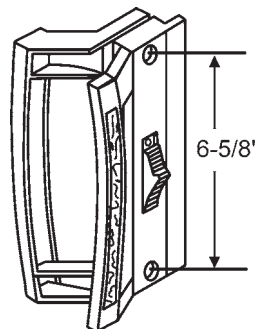

**900-16317**

Black. Includes Keeper and Screws  
**NORANDEX**

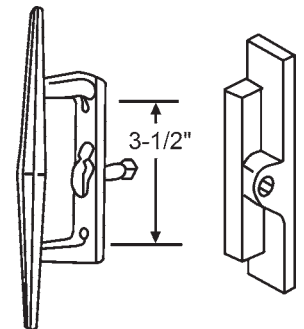

**13-106**

Original Acorn Metal Handle Set  
Base Plate Only: 900-8200  
**ACORN**

# PATIO DOOR HARDWARE

## HANDLE SETS FOR PATIO DOORS

In Order by Style and Hole Spacing

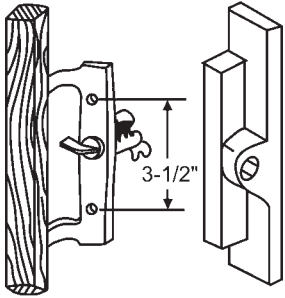

Handle Set without Key Cylinder

Part #	Finish
13-106X	Black

Handle Set with Key Cylinder

Part #	Finish
13-106KX	Black

Both Sets Include Keeper & Screws  
**ACORN REPLACEMENT**

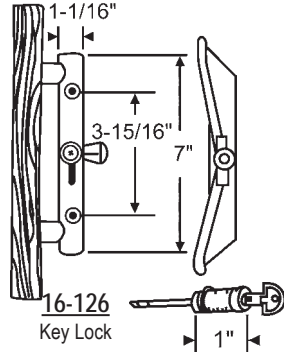

Handle Set with Key Lock

Part #	Finish
13-101	Aluminum w/Brown Handle

Handle Set without Key Lock

Part #	Finish
13-114	Aluminum w/Brown Handle

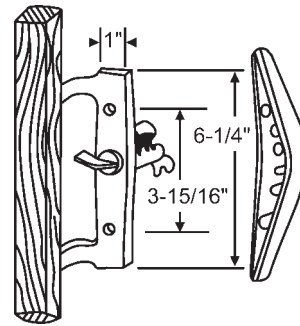

Part #	Finish	Description
13-104	Aluminum	No Key
13-104K	Aluminum	w/Key
13-141	Black	No Key

with 12-240 Keeper

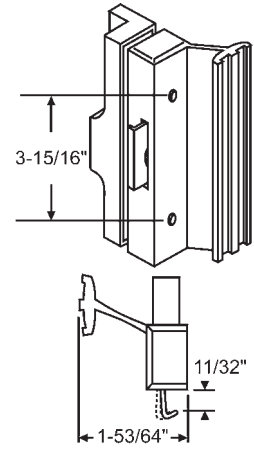

**900-19556**

Aluminum with Black outside pull  
**PENNCO**

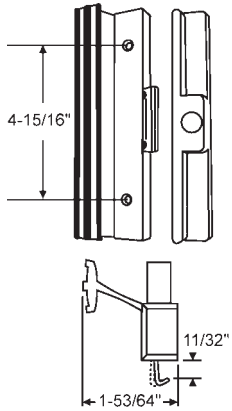

Part #	Handle Finish	Pull Finish
13-195	Black	Black
13-195W	White	White

Plastic Outside Pull  
**BETTER-BILT/TRACO**

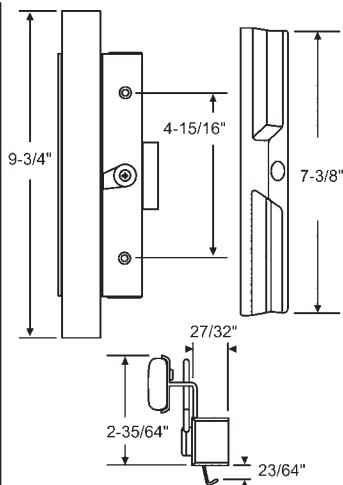

**13-258**

Black Finish. All Metal with Wood Handle  
**ROLLYSON**

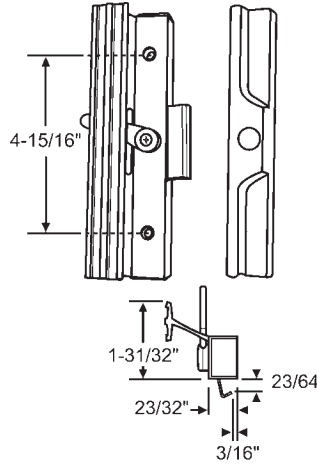

Part #	Finish
13-271	Black
13-271WH	White

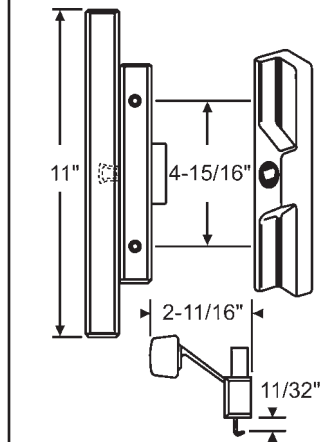

**900-11414**

Black with Wood Handle. Black Outside Pull  
**TRACO**

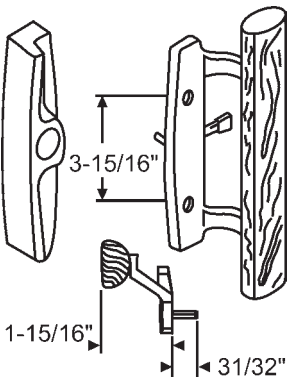

Handle Set without Key Cylinder

Part #	Finish
13-154	Black
13-154W	White
13-154CBZ	Bronze
13-154A	Almond

Handle Set with Key Cylinder

Part #	Finish
13-154K	Black
13-154WK	White

Metal with Wood Handle  
**SASH CONTROLS**

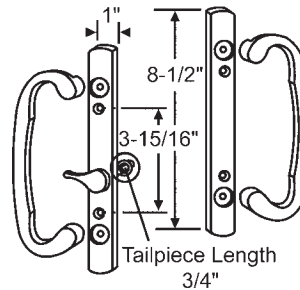

Part #	Finish
13-245BP	Brass Plated
13-245BC	Brushed Chrome
13-245W	White
13-245B	Black
13-245BZ	Bronze
13-245AB	Antique Brass

Offset Latch. 2265 Stamped on Back of Plate. Mortise Lock Sold Separately  
**SASH CONTROLS**

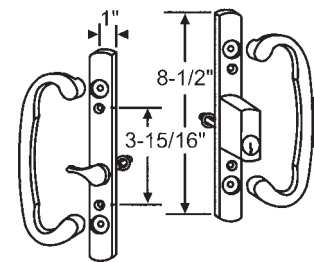

Part #	Finish
13-245WK	White
13-245BPK	Brass Plated
13-245BZK	Bronze
13-245ABK	Antique Brass
13-245BCK	Bright Chrome

Offset Latch. 2265 Stamped on Back of Plate. Mortise Lock Sold Separately  
**SASH CONTROLS**

## HANDLE SETS FOR PATIO DOORS

In Order by Style and Hole Spacing

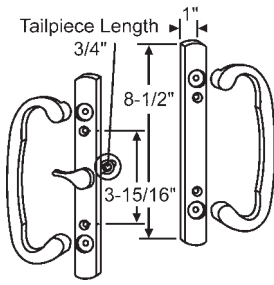

Part #	Finish
13-291	White
13-291B	Black

White. No Key. Center Latch  
2265 Stamped on Back of Plate  
Mortise Lock Sold Separately  
**SASH CONTROLS**

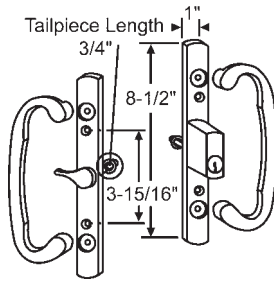

### 13-291K

White. With Key. Center Latch  
2265 Stamped on Back of Plate  
Mortise Lock Sold Separately  
**SASH CONTROLS**

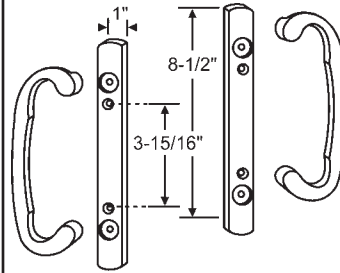

Part #	Finish
13-284DAB	Zinc-Antique Brass
13-284DBC	Zinc-Brushed Chrome

Dummy Set  
Mortise Lock Sold Separately  
**SASH CONTROLS**

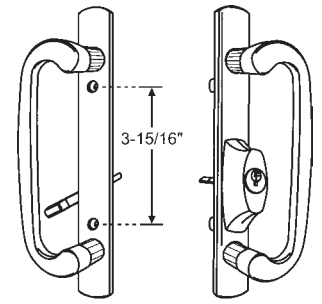

Part #	Description
13-295-10K	Offset Latch w/Key Lock
13-295-10D	Dummy Set

Black

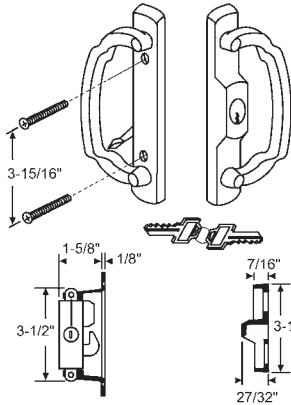

### 13-296PBKA

Solid brass in a polished lacquered finish  
with key combination mortise lock, keeper  
and all necessary screws.  
**PEACHTREE/PRADO**

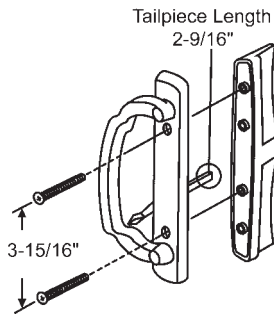

### 13-280

White  
**ACORN**

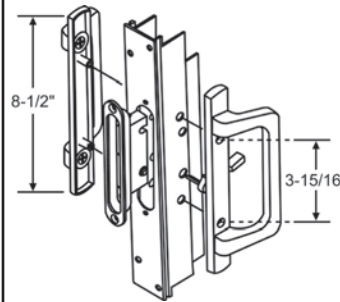

### 13-423-3

White  
For Active Door  
**TRUTH/PGT**

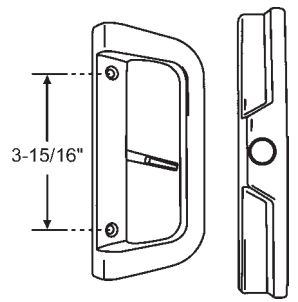

### 13-394-3

White

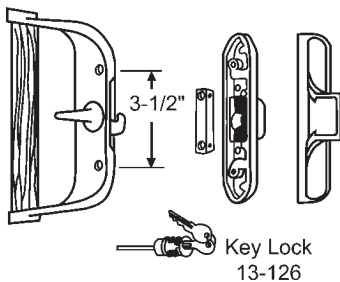

Key Lock  
13-126

Part #	Description
13-188K	w/Key Lock
13-188	No Key Lock

Gray

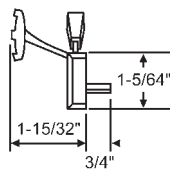
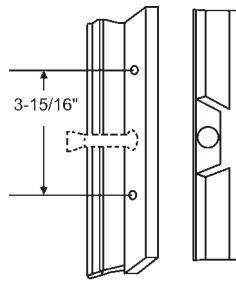

Part #	Description
900-21409W	No Key
900-21409WK	With Key

White

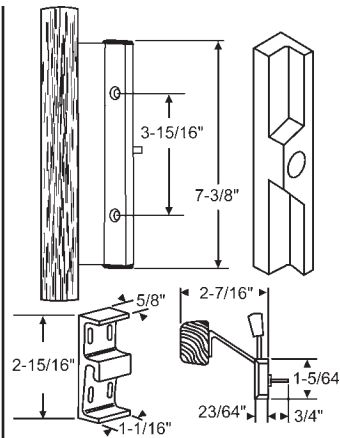

### 13-282BG

Beige. With 11" Solid Oak Bar and Keeper  
**MALTA**

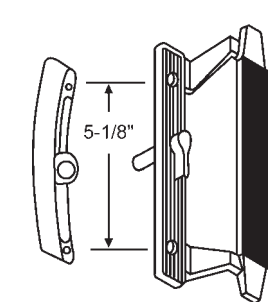

### 13-173

Gray Finish  
13-194 Outside Pull Only  
**HOWARD**

# PATIO DOOR HARDWARE

## HANDLE SETS FOR PATIO DOORS

Alternate lever locations

3-15/16"

1"

1-1/2"

2-1/2"

3-11/16" o/c

**12-299W**  
Keeper

**16-175**  
Mortise Lock

**900-21630**  
White  
**AMERICAN WEATHERSEAL**

3-15/16"

3"

15/16"

9/16"

**900-13021**  
Handle Assembly with Keeper  
Uses 900-9169 Mortise Lock  
**PENNCO**

1-15/64"

1-3/4"

10"

8"

3-15/16"

1-19/64"

15/32"

3-1/8"

4-19/64"

5/8"

Stainless Steel

Part #	Finish	Description
13-341BKA	Black	w/Key, Mortise Lock & Keeper
13-341WKA	White	w/Key, Mortise Lock & Keeper
13-341W	White	No Key, No Mortise Lock & Keeper
13-341WK	White	w/Key, No Mortise Lock & Keeper

Offset Latch

1-3/4"

10"

8"

3-15/16"

1-19/64"

**13-430W**  
White. Center Latch. No Key

8-1/2"

3-15/16"

7-3/8"

1"

1-1/8"

1"

2-15/16"

5/8"

3/4"

3-11/16"

45°

3-3/16"

Part #	Description
13-499WA	Includes Mortise Lock
13-499W	No Mortise Lock

Center Latch. White

8-1/2"

3-15/16"

7-3/8"

1"

1-1/8"

1"

2-15/16"

5/8"

3/4"

3-11/16"

45°

3-3/16"

Part #	Description
13-441WA	Includes Mortise Lock
13-441W	No Mortise Lock

Offset Latch. White

61/64"

7-13/64"

6-37/64"

Green/Red Label

7-3/8"

3-9/32"

1-61/64"

59/64"

**13-526W**  
White

1-1/2"

12-1/2"

7-15/16"

8-1/2"

1-3/32"

2-15/16"

2-3/8"

4-9/16"

1-1/2"

1-1"

6-13/16"

1-21/32"

15/16"

5"

17/32"

1-13/16"

Part #	Finish
13-489WKA	White
13-489MADKA	Almond

Keyed Handle Set  
**PGT 5400 SERIES**

5-1/2"

**900-21292**  
Replacement Black Finish. Used with 16-171 & 16-171SS Mortise Lock  
**ACADIA**

## SLIDING DOOR TRIM SETS

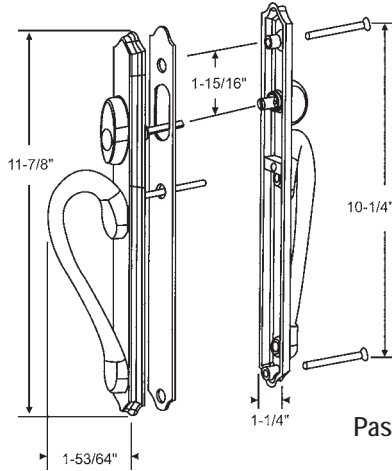

*Used by Marvin Integrity, Comfort Line, Therma Tru, Kolbe & Kolbe*

### Solid Brass Sliding Door Trim Sets

#### Active - Thumb Turn w/Key

For 1.7" Door	
Part #	Finish
13-342AB	Antique Brass
13-342BC	Brushed Chrome
13-342BRS	PVD Brass
13-342CH	Chrome

For 2.0" Door	
Part #	Finish
13-345AB	Antique Brass
13-345B	Black
13-345BC	Brushed Chrome
13-345BRS	PVD Brass
13-345CH	Chrome
13-345ORBZ	Oil Rubbed Bronze
13-345P	Pewter
13-345PB	Polished Brass
13-345SCH	Satin Chrome
13-345SNK	PVD Satin Nickel

#### Active - Thumb Turn No Key

For 1.7" Door	
Part #	Finish
13-343AB	Antique Brass
13-343PB	Polished Brass
13-343ORBZ	Oil Rubbed Bronze
13-343CH	Chrome
13-343BC	Brushed Chrome
13-343SCH	Satin Chrome
13-343P	Pewter
13-343B	Black
13-343BRS	PVD Brass
13-343SNK	PVD Satin Nickel

#### Passive - No Thumb Turn, No Key

For 1.7" Door	
Part #	Finish
13-344PB	Polished Brass
13-344ORBZ	Oil Rubbed Bronze
13-344CH	Chrome
13-344BC	Brushed Chrome
13-344SCH	Satin Chrome
13-344P	Pewter
13-344AB	Antique Brass
13-344AD	Almond
13-344B	Black
13-344W	White
13-344BRS	PVD Brass
13-344SNK	PVD Satin Nickel

### Zinc Die Cast Sliding Door Trim Sets

#### Active - Thumb Turn w/Key

For 1.7" Door	
Part #	Finish
13-346AD	Almond
13-346B	Black
13-346W	White

#### Active (Shown) - Thumb Turn No Key

For 1.7" Door	
Part #	Finish
13-347AD	Almond
13-347B	Black
13-347W	White

#### Passive - No Thumb Turn, No Key

For 1.7" Door	
Part #	Finish
13-348AD	Almond
13-348B	Black
13-348W	White



inspirations

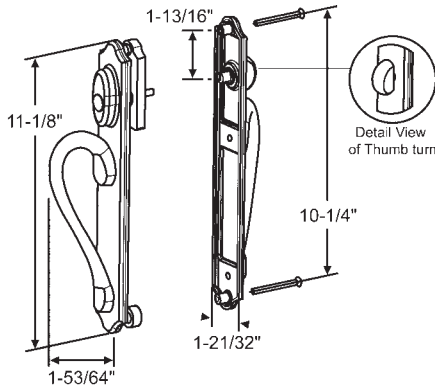

### Solid Brass aesthetically pleasing trim sets and high corrosion resistance

#### Key Features:

- Popular transitional style that is ergonomically friendly
- Popular appearance with first-class finishes
- The home-owner can visually verify that lock is engaged with 90-degree thumb-turn rotation
- The thumb-turn is located above the handle for convenience and ease of use
- With a Schlage C-keyway cylinder, homeowners can key all doors alike
- Integrated key cylinder housing prevents air and water infiltration and offers superior security
- Gasket behind escutcheon plate reduces air infiltration from the exterior
- Weep hole on exterior escutcheon plate prevents water collection

#### Active - Thumb Turn w/Key

Part #	Finish
13-335ORBZK	Oil Rubbed Bronze
13-335BCHK	Bright Chrome
13-335SCHK	Satin Chrome
13-335PK	Pewter
13-335BK	Black
13-335BGK	Beige
13-335WK	White
13-335ABK	Antique Brass
13-335PBK	Polished Brass
13-335BRSK	PVD Brass
13-335SNKK	PVD Satin Nickel

#### Active - Thumb Turn No Key

Part #	Finish
13-335ORBZ	Oil Rubbed Bronze
13-335BCH	Bright Chrome
13-335SCH	Satin Chrome
13-335P	Pewter
13-335B	Black
13-335BG	Beige
13-335W	White
13-335AB	Antique Brass
13-335PB	Polished Brass
13-335BRS	PVD Brass
13-335SNK	PVD Satin Nickel

#### Passive/ Dummy- No Thumb Turn, No Key

Part #	Finish
13-335ORBZD	Oil Rubbed Bronze
13-335BCHD	Bright Chrome
13-335SCHD	Satin Chrome
13-335PD	Pewter
13-335BD	Black
13-335BGD	Beige
13-335WD	White
13-335ABD	Antique Brass
13-335PBD	Polished Brass
13-335BRSD	PVD Brass
13-335SNKD	PVD Satin Nickel

# PATIO DOOR HARDWARE

## OLD FUHR SLIDING DOOR QUESTIONNAIRE

This form is for an Old FUHR Sliding Door Multi-Point System.

NOTE: There are only a few systems available to replace the old FUHR Sliding Door Multi-Point Locks. Please fill out the questionnaire and a sales representative will contact you with part numbers and availability.

Customer Name: \_\_\_\_\_ Account Number \_\_\_\_\_

Contact: \_\_\_\_\_ Phone Number \_\_\_\_\_

- BACKSET:** What is the distance from the edge of the door back to the center of the keyway or thumbturn?  
 1-1/8" (28mm)  1-3/8" (35mm)
- HANDLE HEIGHT FROM CENTER OF HANDLE SHAFT TO BOTTOM EDGE OF DOOR:** (36" Standard) \_\_\_\_\_
- FACE PLATE WIDTH (runs down edge of door):**  5/8" (16mm - Flat Rail System)  1-1/64" (26mm - U-Rail System)
- DOOR PANEL HEIGHT:** \_\_\_\_\_
- IS YOUR DOOR MANUAL OR AUTOMATIC:**  Manual  Automatic

Based on the above information, please review the following : \_\_\_\_\_

Sliding Door Handle Sets Fit FUHR Gear System for 1-3/4" Door Thickness.



392 Back Plate with 574 Handle  
Right Hand Shown

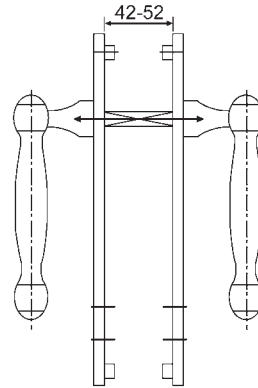
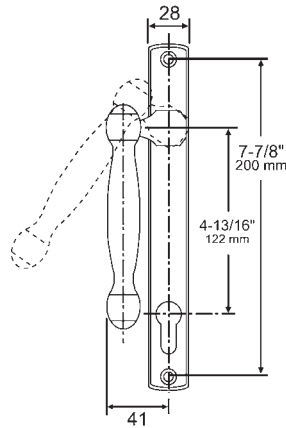

374 Back Plate with 574 Handle  
Right Hand Shown

Active with Cylinder							
	F71 Polished Brass	F73 Antique Brass	F41 Brushed Chrome	F49 Polished Chrome	F9010 White	F9714 Matte Black	F79 Oil Rub Brass
374/574*			850-8764911	850-8763231		850-8771275	850-8764935
392/574	850-8763255	850-8763267	850-8763287	850-8763279	850-8763311	850-8771291	850-8763303
Inactive with Thumb-turn							
374/574*	850-8765883	850-8765903	850-8764923	850-8763223		850-8771279	850-8764939
392/574	850-8763259	850-8763271	850-8763291	850-8763283	850-8763315	850-8771295	850-8763299
Dummy Sets							
374/574	850-8764507	850-8764515	850-8764523	850-8764531	850-8764555	850-8772351	850-8764543
392/574	850-8764451	850-8764459	850-8773199	850-8764475	850-8764499	850-8772355	850-8764483

\* There are limited finishes and quantities available of the 374 back plates. Call your account manager to get the prices and delivery.

## NEW STYLE HOPPE SLIDING DOOR HARDWARE

NOTE: The New Style Hoppe Sliding Door Handle Sets take an American Pizette with a key cylinder and tailpiece.

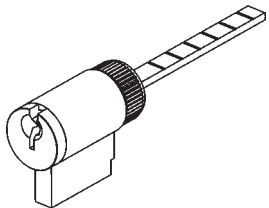

Part Number	Finish
850-2045860	Chrome Plated

Key Cylinder

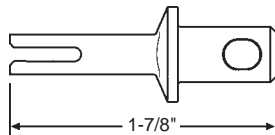

**850-2061421**  
Thumbturn Shaft Coupling



Crescent Knob



**850-8779431**  
Cylinder Knob Set Screw

Part Number	Finish
850-2739116	F77-R Resista Brass
850-8780983	F73 Antique Brass
850-8780963	F41-R Brushed Chrome
850-2739183	F49-R Polished Chrome
850-8780991	F9010 White
850-2739108	F9714 Matte Black
850-2739175	F44-R Antique Nickel
850-8780951	F79 Oil Rub Brass
850-2739204	F8709 Rustic Umber

Individual cylinder knobs do not come with cylinder set screw.



## OUTSIDE HANDLE PULLS FOR PATIO DOORS

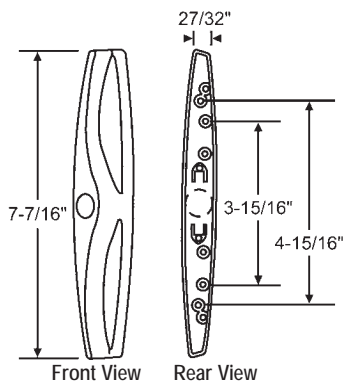

Part #	Finish
13-427B	Black
13-427W	White

Die Cast. No Cylinder Hole

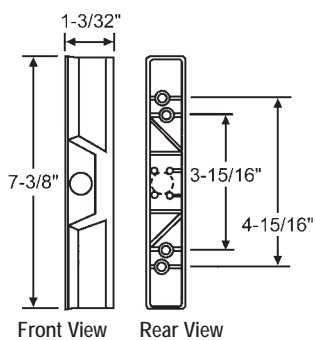

Part #	Description
900-8281	Black Plastic
900-8281M	Black Metal
900-8281MW	White Metal

Without Cylinder hole

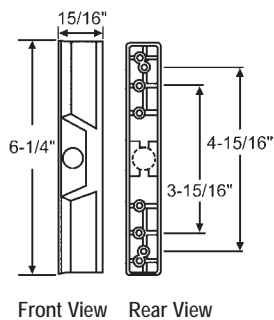

**900-17370**  
Black  
Without Cylinder Hole

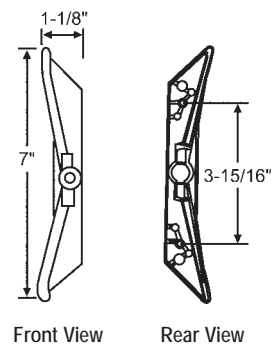

**900-48**  
Aluminum  
Die Cast

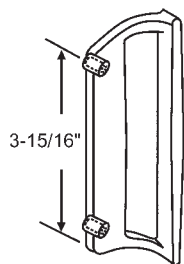

**13-147**  
Flush Mount Pull. Aluminum

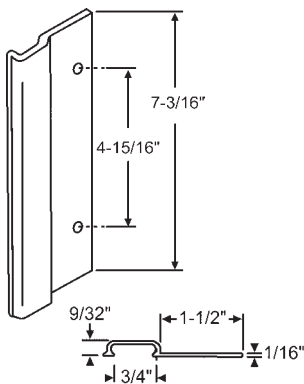

Part #	Finish
16-198	Aluminum
16-199	Black

Outside Pull

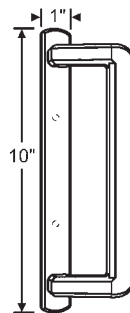

**13-530BZ-E**  
Exterior Handle. Bronze  
**PGT**

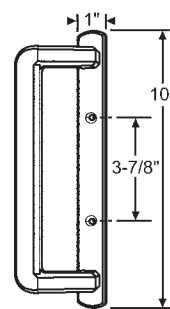

**13-530BZ-I**  
Dummy Interior Handle. Bronze  
**PGT**

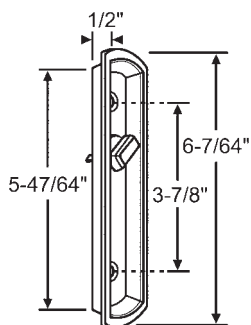

**16-712BZ**  
Interior Recessed Handle with Thumbturn.  
Bronze  
**PGT**

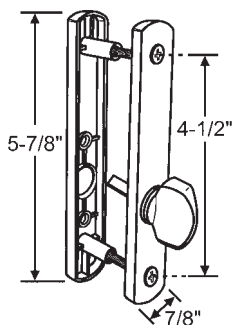

Part #	Finish
16-618DW	Driftwood
16-618W	White

**PGT**

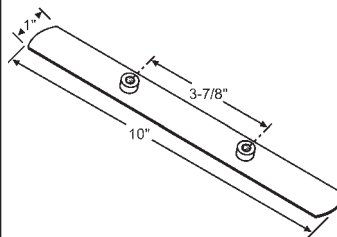

**16-714BZ**  
Exterior Flush Plate Handle. Bronze  
**PGT**

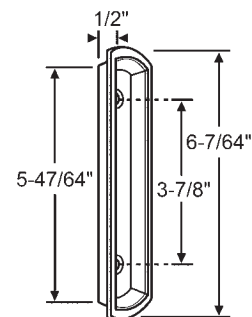

**16-713BZ**  
Interior Recessed Handle Dummy. Bronze  
**PGT**

# PATIO DOOR HARDWARE

## HANDLES FOR PATIO SCREEN DOORS

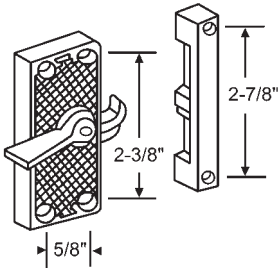

**14-60**

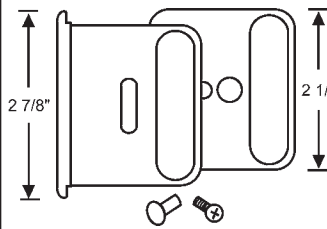

**14-134**  
Black  
**PAN AM**

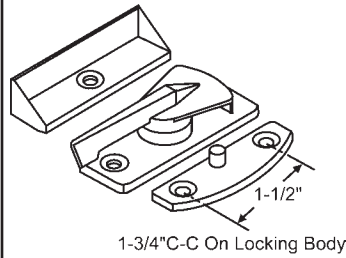

**14-97**  
**HOWARD**

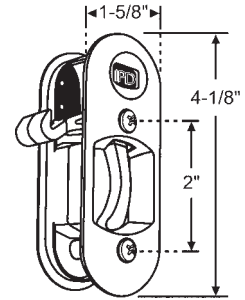

**14-116**  
Almond  
**PEACHTREE**

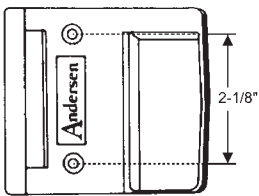

Part #	Finish
750-1997194	Stone
750-1997306	White

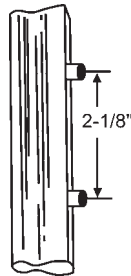

Part #	Finish
750-1997195	Stone
750-1997307	White

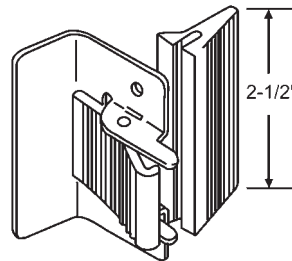

**14-72**

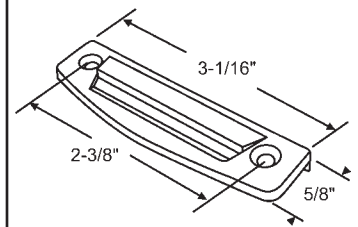

Part #	Finish
16-485B	Black
16-485W	White

Nylon Keeper

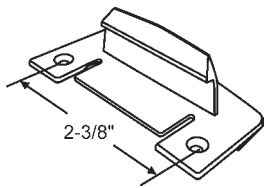

Part #	Finish
16-484B	Black
16-484W	White

Nylon Outside Handle

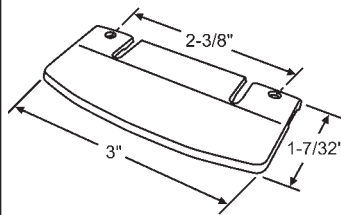

Part #	Finish
16-486B	Black
16-486W	White

Nylon Inside Handle

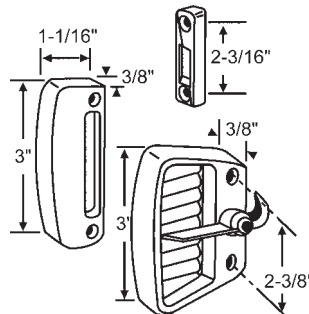

**14-75B**  
Handle Assembly (3 pieces) Black  
**TRACO**

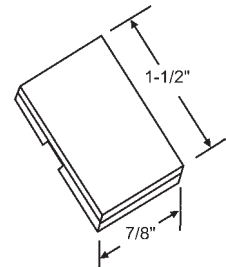

Part #	Finish
16-145	Clear
16-145B	Black

Nylon Latch Handles

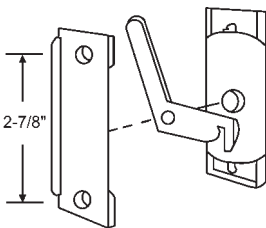

**14-61**  
Handle Assembly with Latch  
**WALTERS**

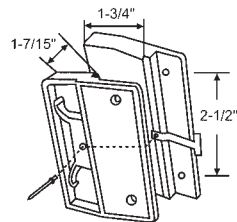

**900-17710**  
Spring Loaded Black Plastic  
**RITE SCREEN/METAL INDUSTRIES**

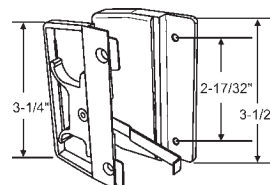

**14-52**  
Black With Keeper and Screws  
**RITE SCREEN**

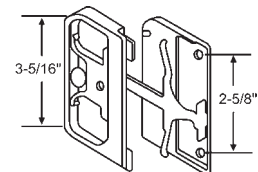

**14-64**  
**METAL INDUSTRIES**

# PATIO DOOR HARDWARE

## HANDLES FOR PATIO SCREEN DOORS

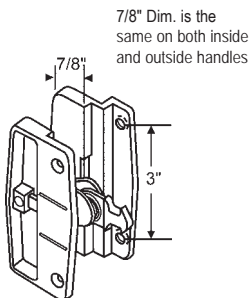

**14-95**  
Handle Assembly  
**COLUMBIA**

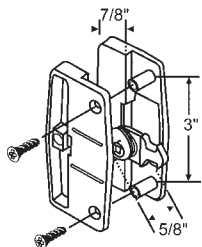

**14-94**

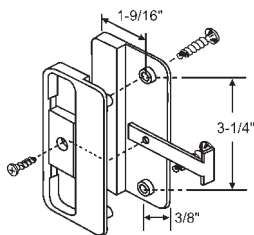

**14-96**  
Handle Set. Black  
**JIM WALTERS**

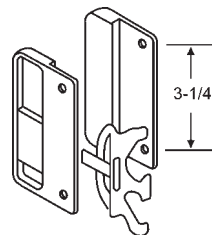

**14-63**  
Handle Assembly  
**JIM WALTERS**

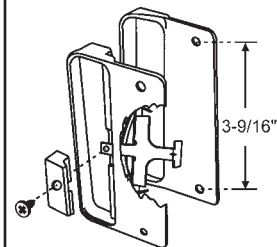

**14-62**  
**ACORN**

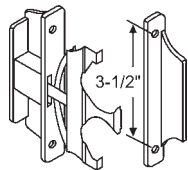

**14-103**  
Black

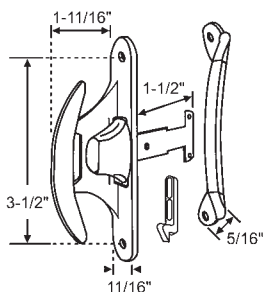

**14-155A**  
Includes Keeper  
**BAYFORM**

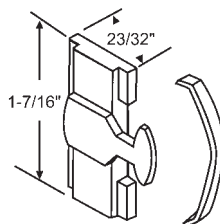

**900-10783**  
Black with Spring  
**CROSSLY**

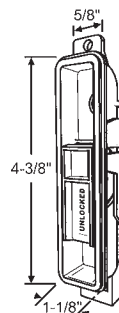

**14-127**  
Plastic Flip Bolt Lever. Beige  
**PEACHTREE**

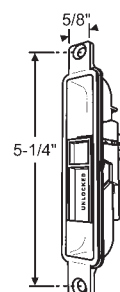

**900-21937**  
Plastic Lever Assy. Beige  
**PEACHTREE/ PRADO**

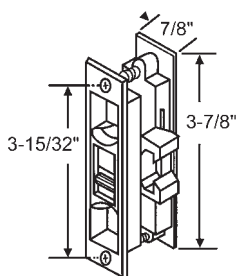

**900-11214**  
Patio Screen Latch Assembly  
Includes 12-308 Keeper  
**PEACHTREE**

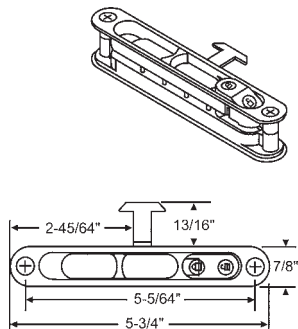

**14-138**  
Screen Door Lock. Black  
**RITE SCREEN**

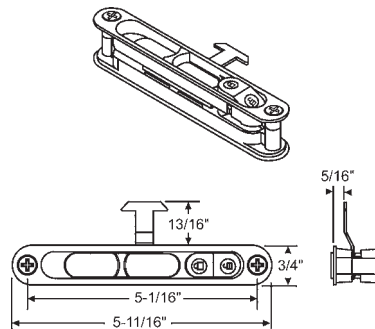

**14-170B**  
Recessed Patio Door Screen Handle. Black  
**FLORIDA SCREEN REGAL SERIES**

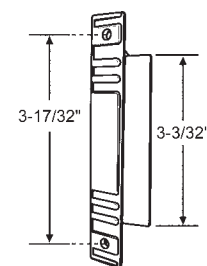

Part #	Finish
14-147W	White
14-147DT	Desert Tan

Inside Screen Pull Handle

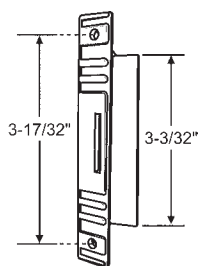

Part #	Finish
14-151BR	Brown
14-151B	Black

Inside Screen Pull Handle. Brown

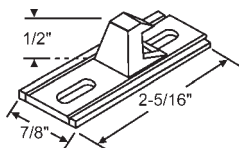

**12-308**  
Black Plastic  
**PEACHTREE**

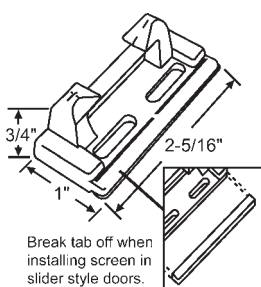

**900-21646**  
Beige  
**PEACHTREE**

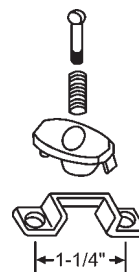

**14-51**  
Latch Assembly  
**ACORN**

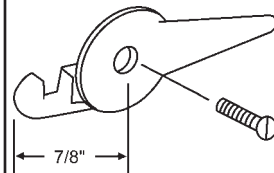

**14-54S**  
Latch Assembly with Spring

# PATIO DOOR HARDWARE

## PATIO DOOR SCREW HOLE COVERS

## SCREEN DOOR GUIDES

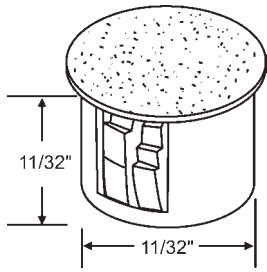

**16-335**  
Large Cover  
Black

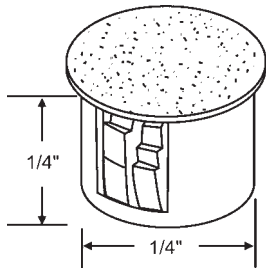

**16-336**  
Small Cover  
Black

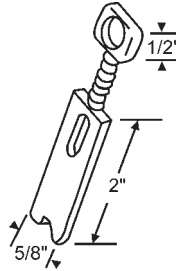

**15-50**  
**TUCKER**

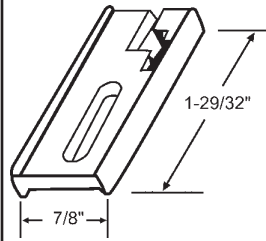

**15-51**  
**CROSSLY**

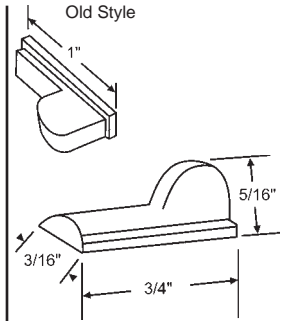

**900-6902**  
**CROSSLY/LUMIDOR**

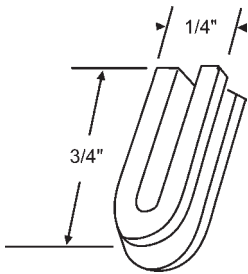

**15-94**  
**DARYL**

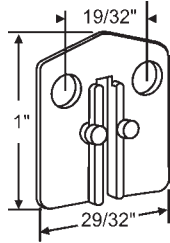

**900-10073**  
Nylon  
**LAWSON/CROWN**

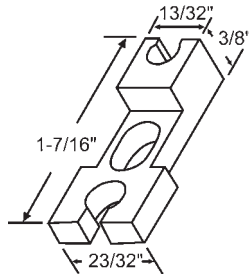

**15-62**  
**MILLER**

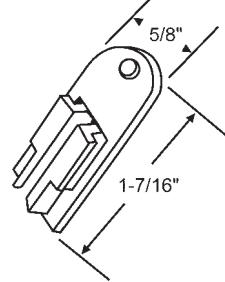

**15-63**

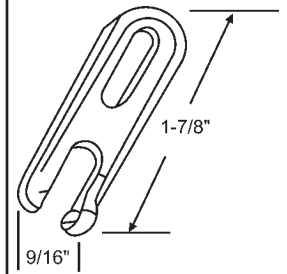

**15-55**  
Screen Guide  
**CROSSLY**

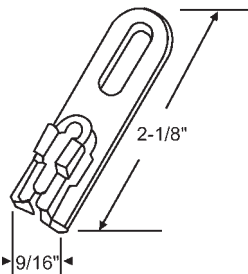

**15-54**

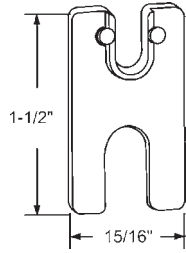

**900-10074**  
Nylon  
**LAWSON/CROWN**

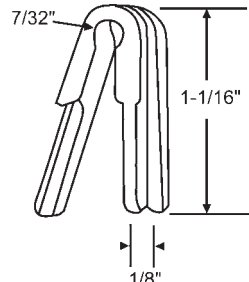

**900-71**  
**MILLER**

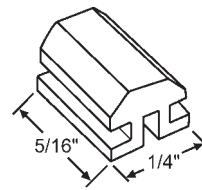

**52-846**  
White  
**PAN AM/BINNINGS**

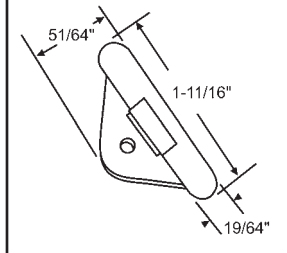

**15-66**  
Nylon  
**ALCAN**

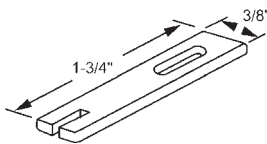

**15-65**  
Nylon  
**BELLVIEW**

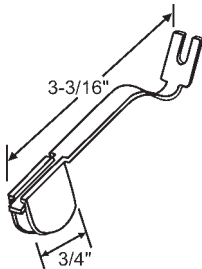

**15-57**  
Nylon  
**ACORN**



**900-15649**  
**TM PRODUCTS**

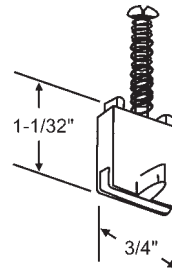

**900-84**  
Bottom Guide  
**TUCKER**

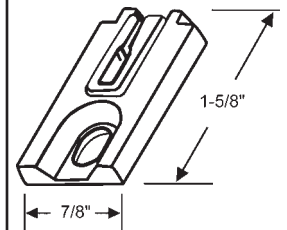

**15-52**  
Top Guide  
**DARYL**

# PATIO DOOR HARDWARE

## SCREEN DOOR GUIDES

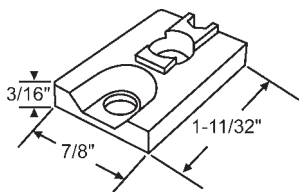

**900-78**  
Bottom Guide  
**TUCKER**

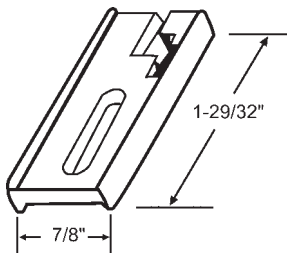

**15-51**  
Bottom Guide  
**CROSSLY**

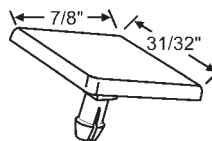

**900-7236**  
Screen Head Spacer. Nylon

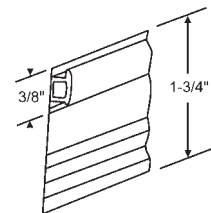

Part #	Length
16-243	50 ft.
16-243M	250 ft.

Can Be Torn Away in 3/16" Increments. Black

## FIXED PANEL BRACKET

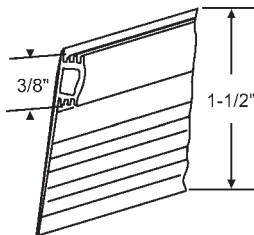

Part #	Length
16-244	50 ft.
16-244M	250 ft.

Can Be Torn Away in 1/8" Increments

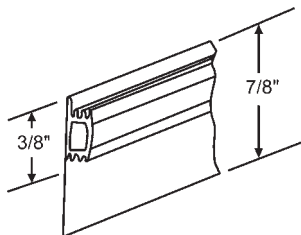

Part #	Length
16-245	50 ft.

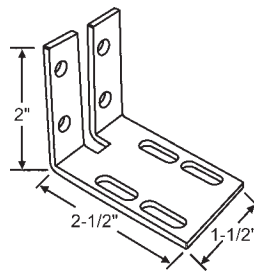

**16-621**  
**PGT**

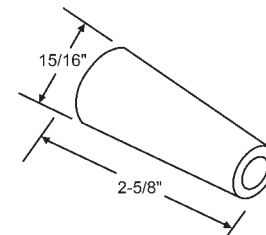

Part #	Finish
16-227B	Black
16-227W	White

Rubber

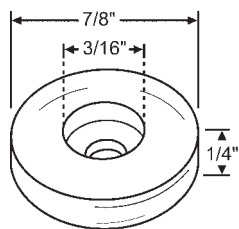

**900-19153**  
Clear Plastic

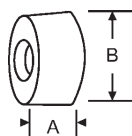

Part #	A	B	Finish
16-105	3/8"	15/16"	Gray
16-107	7/32"	3/4"	White

Rubber

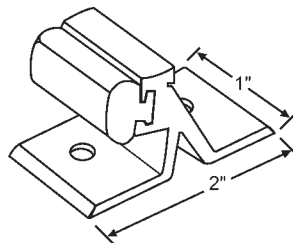

**16-579**  
Aluminum  
**MILLER**

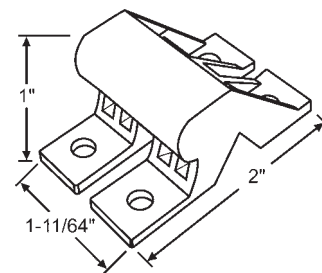

**16-620W**  
White  
**PGT**

## ANTI-LIFT

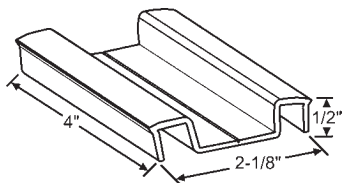

**16-715TN**  
Tan  
**PGT**

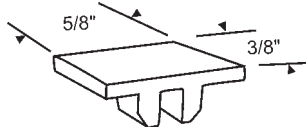

Part #	Finish	Description
15-88	Black	for Steel Doors
15-89	White	for Aluminum Doors

Anti-Rattle Guides

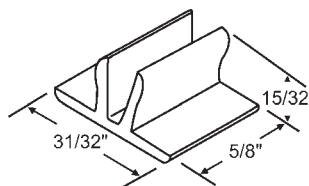

**900-7228**  
Nylon

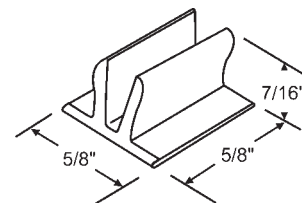

**900-7225**  
Nylon

# SECURITY HARDWARE

## SECURITY HARDWARE & PATIO DOOR LOCKS

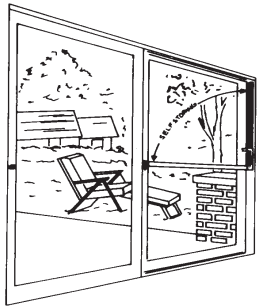

### Charley-BAR

Safety Lock

**STOP**  
BURGLARS

Makes Sliding Glass  
Doors Jimmy-Proof!

**NEW STEEL  
SAFETY KEY  
LOCK**

- Key hangs neatly out of your way when not in use
- Comes with all necessary hardware and instructions
- Available in three lengths, three finishes and three packages
- Anodized Aluminum construction allows it to be cut to fit any size door
- New security feature: Improved black plastic saddle now takes a key so that the bar cannot be raised from the outside by wires or other devices
- New saddle keeps small children from opening the door from the inside

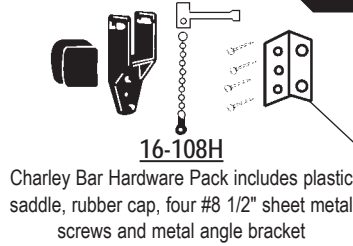

**16-108H**

Charley Bar Hardware Pack includes plastic saddle, rubber cap, four #8 1/2" sheet metal screws and metal angle bracket

Mailing TUBE - 50 per carton  
sold in carton qty only

Part #	Size	Finish
16-108T	48"	Mill
16-108TB	48"	Bronze
16-108TW	48"	White

Carded - 10 per carton sold  
in carton qty only

Part #	Size	Finish
16-108C	48"	Mill
16-108CB	48"	Bronze
16-108CW	48"	White

BULK - 25 per carton

Part #	Size	Finish
16-108	48"	Mill
16-108B	48"	Bronze
16-108W	48"	White
16-108-60	60"	Mill

Poly Bagged - 50 per Box

Part #	Size	Finish
16-108P	48"	Mill

## SECURITY LOCK

### Security Lock

for both sliding glass doors and windows

MADE OF UNBREAKABLE  
LEXAN

Super Holding Power

Installs Without Tools

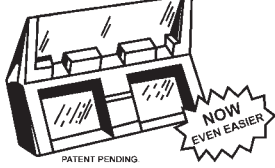

- Installs quickly without special tools.
- 3-M special adhesive bonds to glass like a weld
- Provides positive locking protection.
- Secures both sections firmly.
- Unbreakable GE Lexan.
- Crystal-clear transparency.

**16-192**  
Sold in Pairs

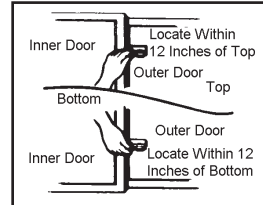

Glass Door Installation:  
Position both Security Locks within  
12 inches of top and bottom on outer  
door flush against inner frame.

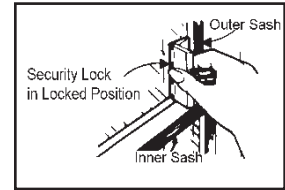

Sash Window Installation:  
Position one Security Lock flush  
in lower corner of top window.

## SECURITY LATCH

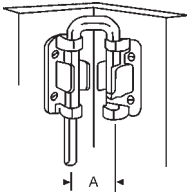

**NARROW FOR EXTRA TIGHT CORNERS**  
Where moldings and jams are narrow and mounting space is limited; 3/4" shackle width.

Part #	Finish	"A"
16-185	Nickel	1-1/8"
16-185B	Black	1-1/8"
16-185BR	Brass	1-1/8"
16-185W	White	1-1/8"

**STANDARD FOR MOST CORNER APPLICATIONS**  
Where ample mounting space is provided; 1-1/4" shackle width.

Part #	Finish	"A"
16-186	Nickel	1-7/16"
16-186B	Black	1-7/16"
16-186BR	Brass	1-7/16"
16-186W	White	1-7/16"

**WIDE FOR OFFSET MOUNTING**  
Where reaches require wider shackle to bridge wide gaps between jams and moldings to wall; 2" shackle width.

Part #	Finish	"A"
16-187	Nickel	2-1/8"
16-187B	Black	2-1/8"
16-187BR	Brass	2-1/8"
16-187W	White	2-1/8"

"A" Dimension  
equals exact center to  
center measurement

- Simple to install
- Very easy to use
- Attractive finishes
- Prevents accidental locking

- Can be used on windows too
- Assures snug closure of door
- All mounting hardware included
- Reversible (Works left to right or right to left)
- Latch serves as convenient handle for door

- Makes handy latch for all regular swinging doors
- Mounts anywhere along frame for easy accessibility
- Presently being used by the hospitality industry nationwide
- Sturdily constructed (Handle made from 9/32" steel rod stock)

## SECURITY HARDWARE & PATIO DOOR LOCKS

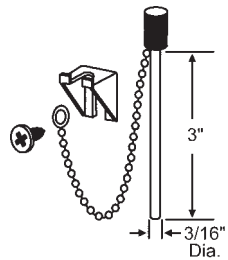

**16-104**  
Burglar Pin/Nite Lock

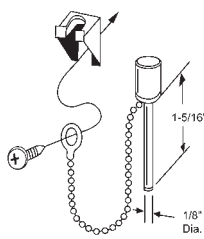

**16-431**  
Burglar Pin/Nite Lock  
Aluminum Finish

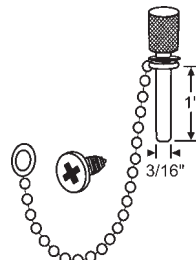

**900-1099**  
Travel Lock

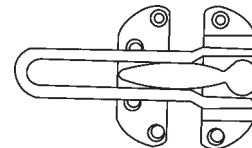

Part #	Finish
16-225C	Chrome
16-225PB	Brass

Door Guard

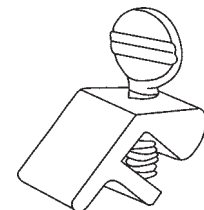

**50-682**

## SECURITY HARDWARE & PATIO DOOR LOCKS

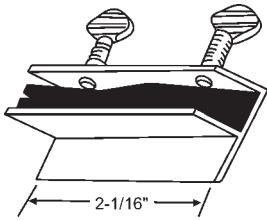

**50-636**

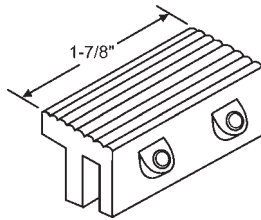

Part #	Finish
900-17508	Black
900-17508A	Aluminum

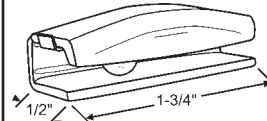

**900-10574**  
Snap-on Vent Lock

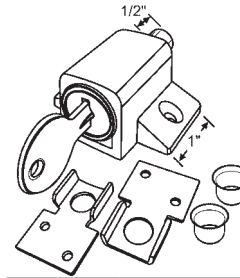

Part #	Finish
900-9718W	White
900-9718	Black

Heavy Duty Die Cast.  
1-1/4" Hole Center. Includes  
2 Keeper, 2 Ferrules and  
Installation Screws

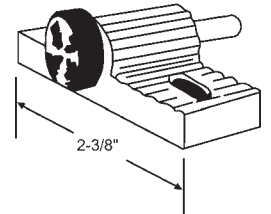

Part #	Finish
16-177	Aluminum
16-177B	Black

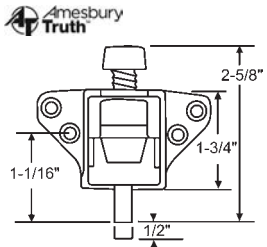

Part #	Finish
16-209-1	Bronze
16-209-3	White

Secondary Patio Lock  
Screws Sold Separately

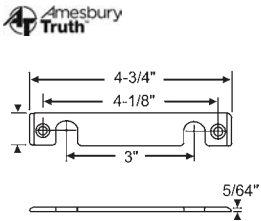

Part #	Finish
12-264-1	Bronze
12-264-3	White

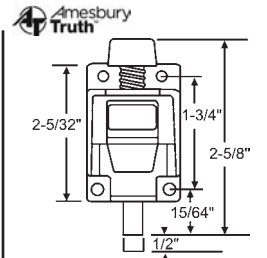

Part #	Finish
16-211-1	Bronze
16-211-3	White

Wingless Patio Lock  
Screws Sold Separately

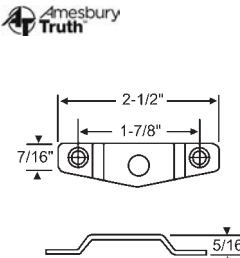

Part #	Finish
12-265-1	Bronze
12-265-3	White

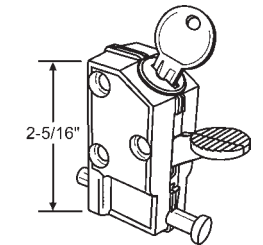

**16-682**  
Mill Finish w/2 Keys  
Pin Length 3/4"

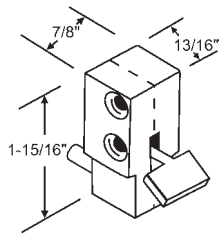

**900-8734**  
Aluminum

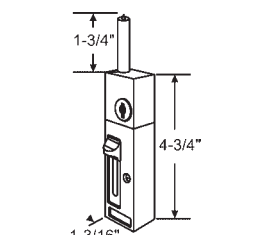

**16-687**  
Security Lock. Aluminum

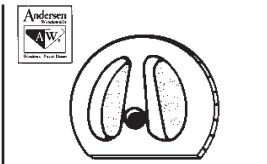

**750-1997192**  
Two Panel Screen Door Lock  
Stone

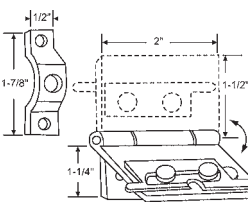

**16-406**  
Aluminum Flip Lock

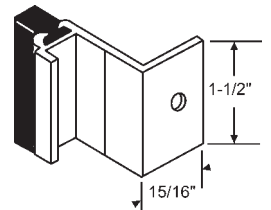

**16-183**  
Fixed Panel Clip

## KEY CYLINDERS

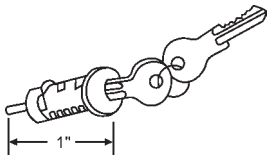

Part #	Description
16-100	for 1" Door
900-21366	for 1-1/4" Door

Key Cylinder Lock

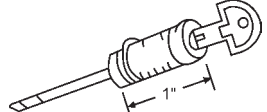

**16-126**  
Key Cylinder

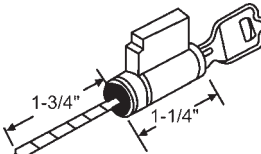

**16-133**  
Key Cylinder Lock

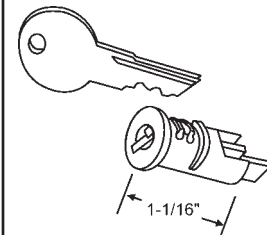

**16-103**  
Key Cylinder for 1-1/8" Door

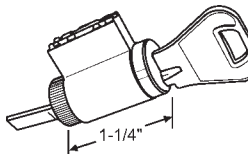

**900-11179**  
Key Cam  
**PEACHTREE**

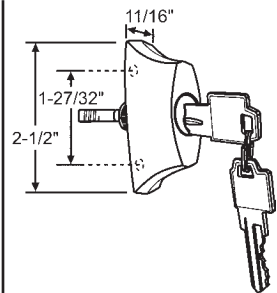

**16-617SV**  
Lock Housing and Key  
**PGT**

## MORTISE LOCKS

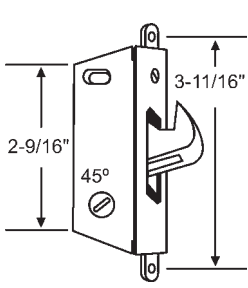

**16-170**  
Square Face

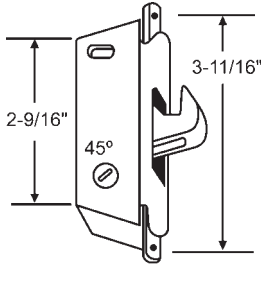

**16-171**  
Round Face

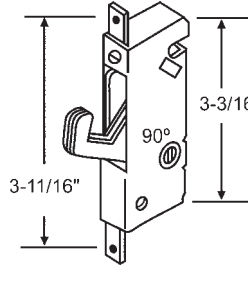

**16-173**  
Square Face

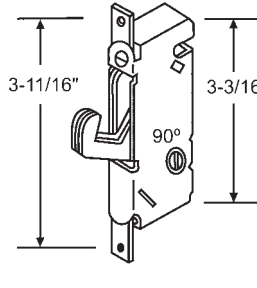

**16-174**  
Round Face

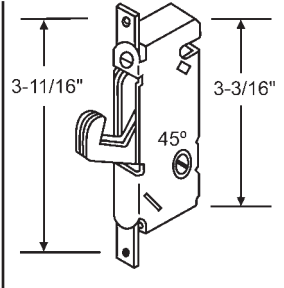

**16-175**  
Round Face

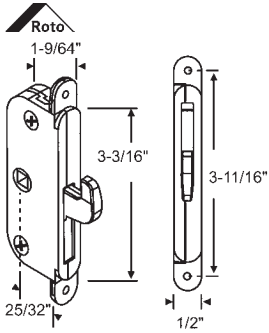

**16-490**  
Single Point Slider Lock

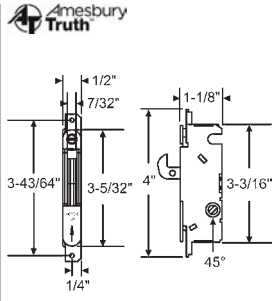

Part #	Description
16-397SS	Stainless Steel
16-397	Clear Chrome

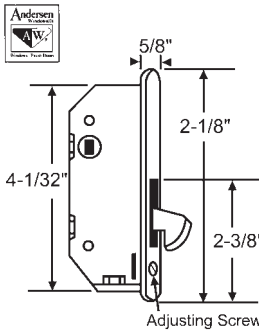

**750-1997156**

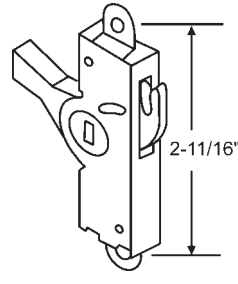

**16-142**  
Used for Surface Mounted  
Patio Door Handle

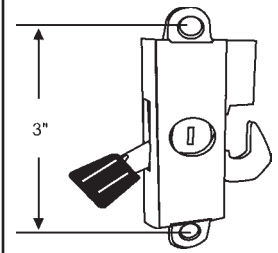

**900-7305**  
Flush Button, Front Surface  
Mounted Steel Hook  
**PEACHTREE**

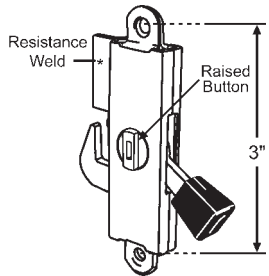

**16-673**  
Raised Button, Front Surface  
Mounted Steel Hook  
**PEACHTREE**

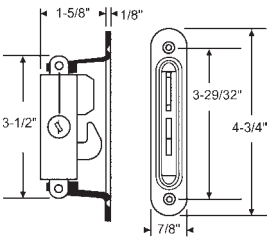

**900-18867**  
Diagonal Hub, Aluminum Finish  
Use: 900-14560 for Keeper  
**TRACO**

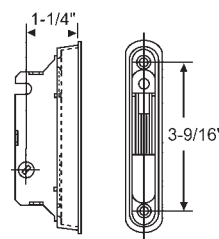

**16-443**  
Mortise Lock and Plate

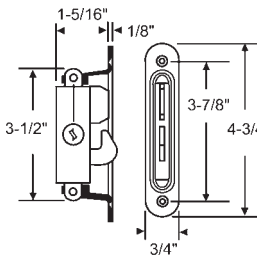

**900-9169A**  
Includes Keeper

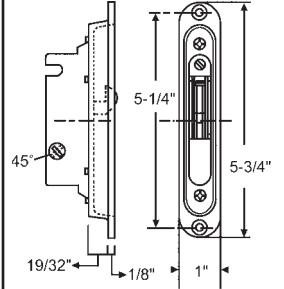

**16-441-45**  
Pocket Trim Plate with 16-175.  
Brass Plated

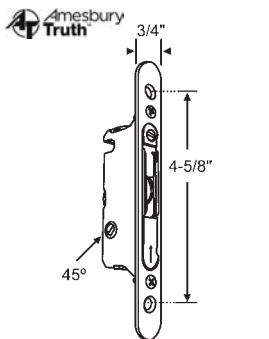

Part #	Finish
16-363-45	Brass Plated
16-363-45SS	Stainless Steel

With Faceplate and 16-175

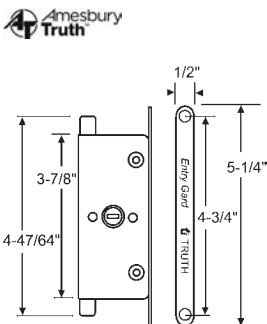

**16-685**  
Multi Point

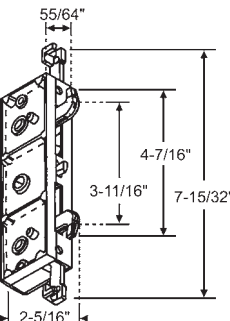

**16-542**  
Milgard Classic Series

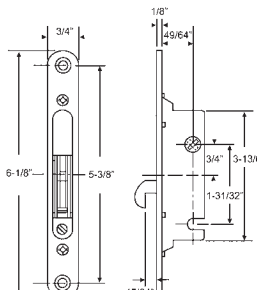

**16-333**  
**PEACHTREE**

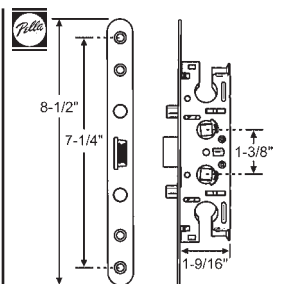

Part #	Finish
19-504B	Black
19-504G	Green
19-504PY	Pully
19-504TN	Tan
19-504W	White

Storm Door Mortise Lock



# PATIO DOOR HARDWARE

## MORTISE LOCKS

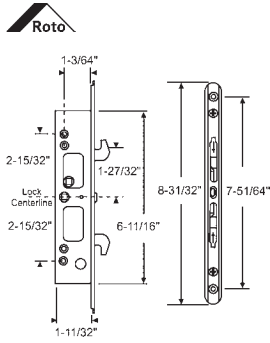

**16-460**

2-Point Patio Door Lock

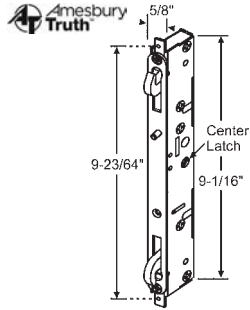

Part #	Finish
16-453	Steel
16-453SS	Stainless Steel

Two Point Mortise Lock w/ Short Face Plate.  
Center Latch Thumbturn

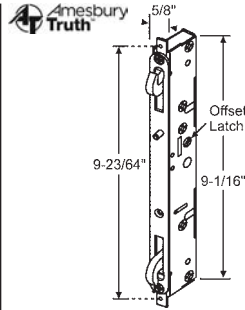

Part #	Finish
16-455	Steel
16-455SS	Stainless Steel

Two Point Mortise Lock w/ Short Face Plate.  
Offset Latch Thumbturn

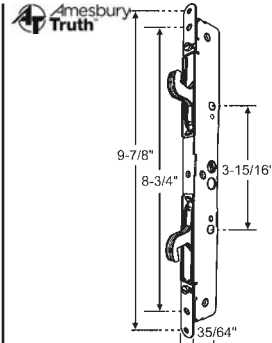

Part #	Finish
16-574	Steel
16-574SS	Stainless Steel

Dual Hook Mortise Lock

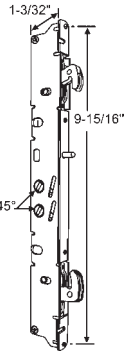

Part #	Finish
16-680	Steel
16-680SS	Stainless Steel

No Trimplate  
**GEMINI I & II**

## KEEPERS

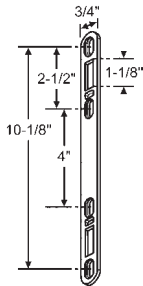

Part #	Finish
16-680FK	Steel
16-680FKSS	Stainless Steel

Flat Keeper  
**GEMINI I & II**

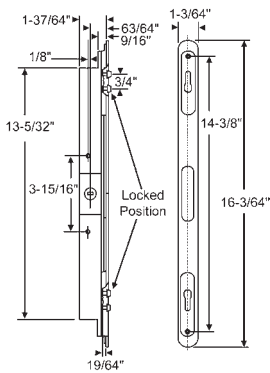

**16-440W**  
With Trimplate

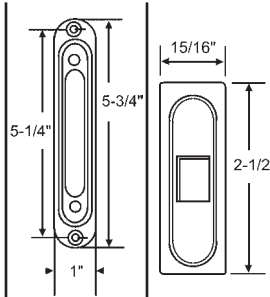

**900-17354P**  
Pocket  
Trimplate. Zinc  
Dichromate

**12-303**  
Escutcheon  
Plate Black  
Plastic  
**MILLER**

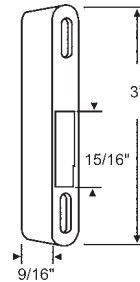

**900-8856**  
Die Cast Keeper for 900-9169

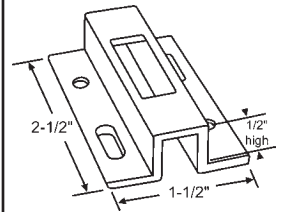

**12-299W**  
White

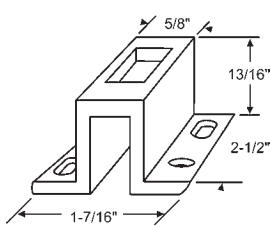

Part #	Finish
12-290W	White
12-290AD	Almond

**900-69**  
Die Cast  
**YALE OGRON**

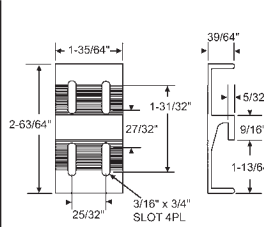
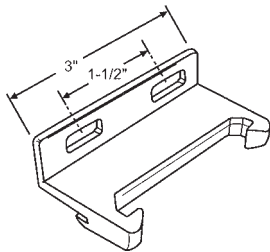

**12-286W**  
White, Four Slot

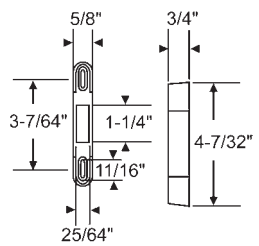

**12-294**  
Yellow Chromate Plated

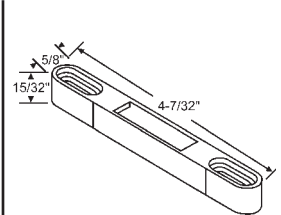

**900-17355**  
Die Cast  
**PEACHTREE**

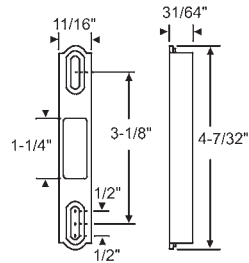

**12-271**

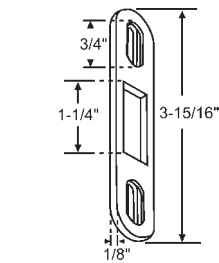

**12-272**  
Flat. For 12-247 & 13-248 Patio  
Door Handles

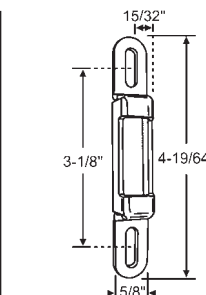

Part #	Finish
12-319	Dichromate
12-319SS	Stainless

13/64" x 11/16" Elongated Holes

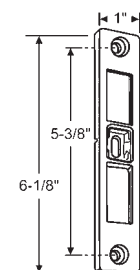

Part #	Finish
12-329STW	Satin White
12-329TN	Tan

Strike Plate. Used with 16-542  
**MILGARD**

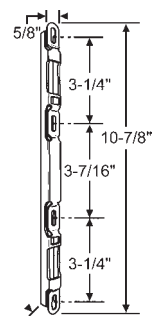

**900-22553SS**  
Surface Keeper.  
Stainless Steel

# PATIO DOOR HARDWARE

## KEEPERS

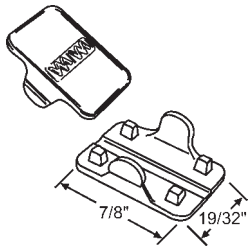

**12-330**  
Strike Plate Screen Cover.  
Plated. Used with 16-542  
**MILGARD**

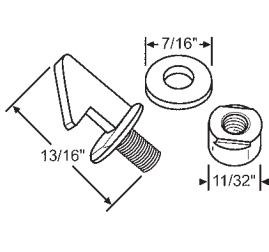

**900-61**  
w/ Nut & Nylon Washer  
Patio Door Keeper  
**DARYL**

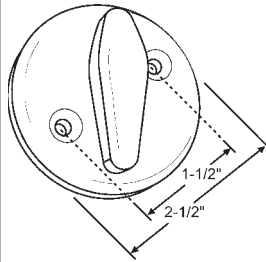

**16-619BR**  
Door Turn for French Doors.  
Bronze  
**PGT**

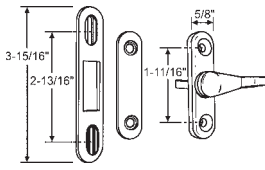

Part #	Finish
16-702B	Black
16-702BZ	Bronze
16-702SV	Silver
16-702W	White

Thumbturn Kit  
**PGT**

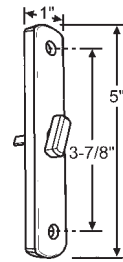

**16-623BZ**  
Secondary Thumb Latch. Bronze  
**PGT**

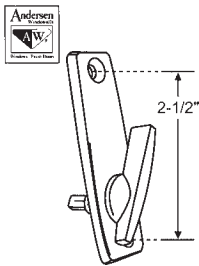

**750-1278303**  
Stone

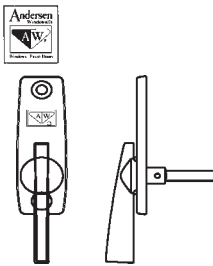

No Longer Available.  
Use: 750-2573611

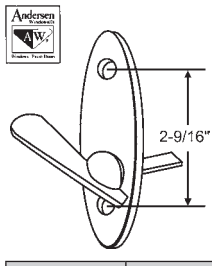

Part #	Finish
750-2573611	Stone
750-2573609	White

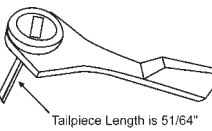

**900-11040**  
Turn Lever with Tailpiece  
Black

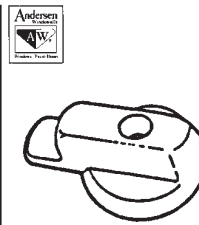

Part #	Finish
750-0924602	Stone
750-2579551	White

**16-373**  
Patio Door Latch. Die Cast  
**ACORN**

## LOCK BARS



**750-1997305**  
Stone

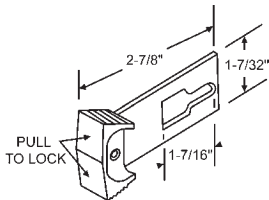

**16-188**  
Lock Bar Without Key  
**CAPITOL**

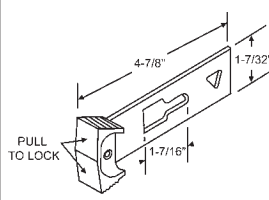

**16-230**  
4-7/8" Lock Bar  
**CAPITOL**

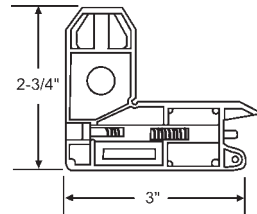

**16-116-2**  
Screen Corner Bracket Assembly  
with Screw. 2 per Pack

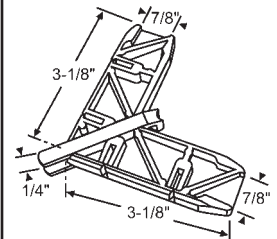

**16-361PW**  
White Nylon Miter Corner  
Use on Door 991M-999

## CORNER BRACKETS

## REPAIR TRACKS

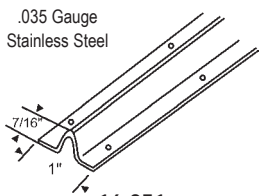

**16-251**  
Replacement Track Cover.  
8' Lengths. Sold in multiples of 5  
only. Heavy duty. Recommended  
for tracks that are too corroded  
to use 16-115. Repairman's "first  
choice" in door  
replacement track.

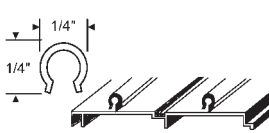

Part #	Length	Minimum Order
16-115	8ft.	(10 8ft. Lengths)
16-115-6	6ft.	(10 6ft. Lengths)

Replace bent or broken door  
tracks with stainless steel  
replacement tracks.  
Easy to use. Snaps into place  
over old broken track.

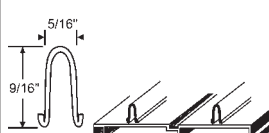

Part #	Length	Minimum Order
16-115BS	8ft.	(5 8ft. Lengths)

Replace bent or broken door  
tracks with stainless steel  
replacement tracks.  
Easy to use. Snaps into place  
over old broken track.

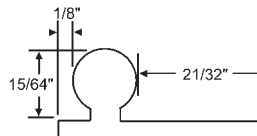

Part #	Length	Finish
16-217-6	6ft.	Anodized
16-217-8	8ft.	Anodized

Glass Door Track Extrusions  
1/16" Thick x 15/16" Wide

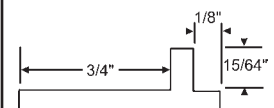

Part #	Length	Finish
16-219-6	6ft.	Anodized
16-219-8	8ft.	Anodized

Screen Door Track Extrusions  
1/16" Thick x 15/16" Wide.

We are the largest National Stocking Distributor for HOPPE® North America. We have over 500 SKU's available for immediate shipment. HOPPE® North America is one of the leading manufacturers of door hardware.

These pages are designed to give you a sampling of the various products and finishes HOPPE® has to offer. HOPPE's® Single Design Theme is unique to the door industry and has changed and upgraded the look of American households across the country.

We are dedicated to assisting and servicing you on acquiring the quality products from HOPPE® North America.



Do you want the hardware on your entry door, interior doors, patio door and windows to match? Who wouldn't? HOPPE® North America, Inc. carries the full range of products so you can continue the single design theme throughout your entire home, for all your residential doors and windows.

The HOPPE® North America, Inc. hardware program also includes a wide range of products such as multipoint locks and handle sets with cylinders, plus adjustable hinges for doors and turn & tilt hardware for windows. Why hasn't anyone thought of this before? Bet you are glad we did.

**Styles and Finishes**

Contact account manager for part numbers and prices.



**Athinai Series in Polished Chrome with Brushed Stainless Steel**

Reminiscent of a strong heritage, the classic sleek curves of the Athinai Series will accent the décor of any room.



**München Series in Polished Chrome**

Curves and flair distinguish the München Series handles. Reminiscent of hearty European design, your traditional handles will stand the test of time throughout your home.



**Verona Series in Polished Brass**

Soft, sleek lines add to the contemporary design of your home. Available in interior and entry functions, Verona Series handles will complement every room in your home.



**Ródos Series in Satin Nickel**

Majestic and regal, Ródos Series handles represent the ultimate in decorative, European styling and decoration throughout your home.



**New Orleans Series in Matte Black**

Time honored traditional design will complement the style of your home. With slim, lustrous form, New Orleans series handles are the right fit for every member of the family.



**Toronto Series in Antique Brass**

With a touch of provincial and a touch of cosmopolitan, Toronto Series handles complement a wide range of interior designs.



Ródos Series shown with Antique Nickel Finish



New Orleans Series with Brushed Chrome Finish



Toronto Series shown with Oil Rubbed Brass Finish



Polished Brass (F77-R)



White (F9010)



Brushed Chrome (F41-R)



Antique Nickel (F44-R)



Polished Chrome (F49-R)



Brown (F05)



Antique Brass (F73)



Matte Black (F9714)



Oil Rubbed Brass (F79)



Nickel (F01)



Satin Nickel (F42-R)



Rustic Umber (F8709)

## München Series

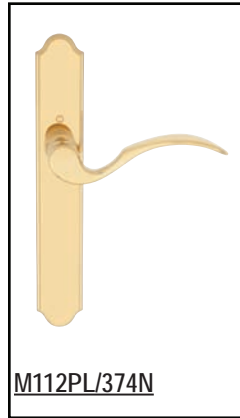
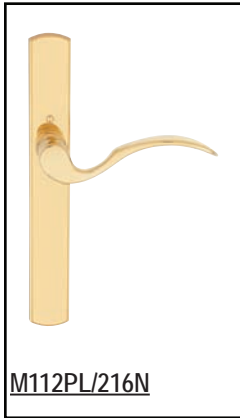

## Verona Series

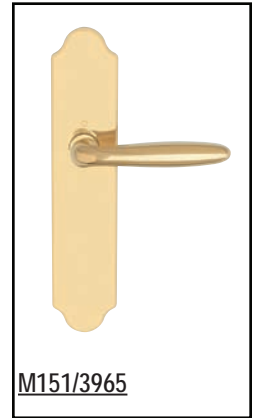
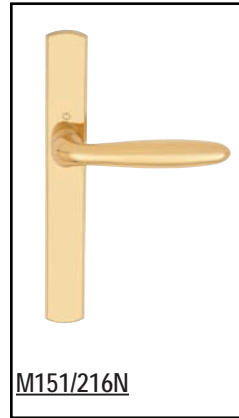

## New Orleans Series

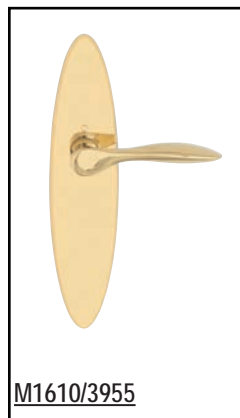

## Ródos Series

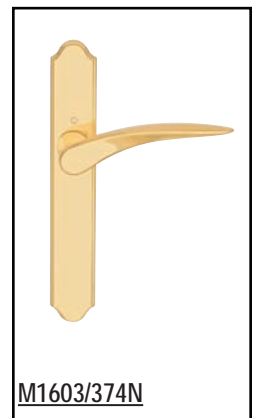
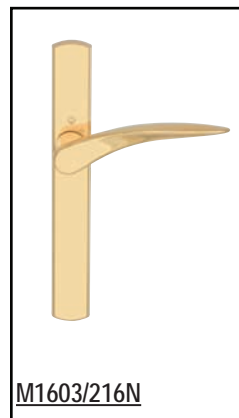

## Toronto Series

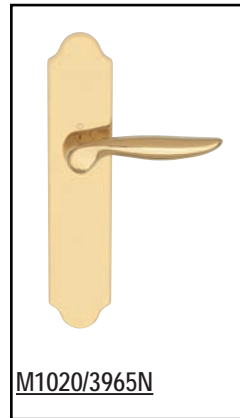
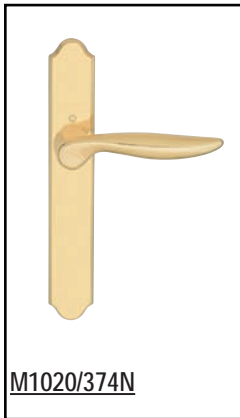

## Athinaí Series

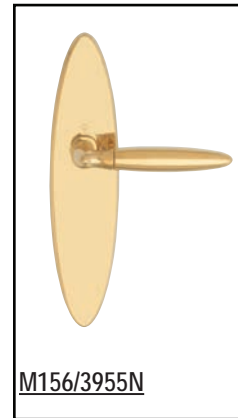
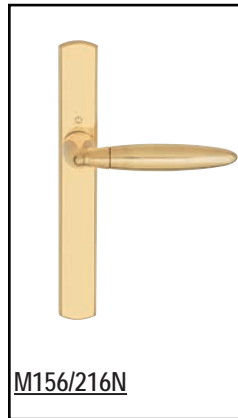

## Dallas Series



Back Plates, Handles, Cylinders, etc. are available separately.

All HOPPE® Swing Door Handles are available in Active, Inactive and Dummy sets.

Multi-Point/Single-Point Locking Systems sold separately. Contact account manager for pricing

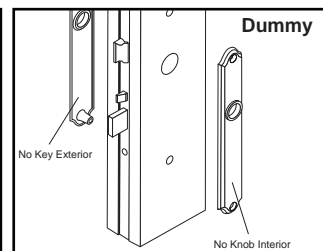
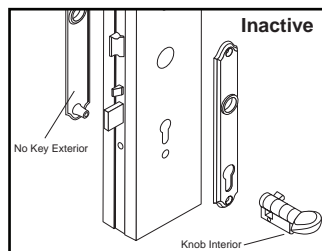
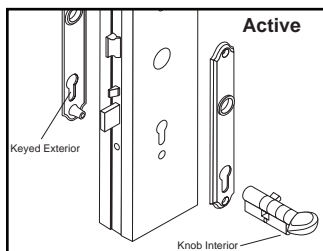





Part #	Description
850-2604801	Handle Set Only
850-2605353	Handle Set with Construction Key

**Profile Cylinder Accessories Rekeying Instructions**

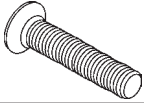
- Rekeying should be done by a qualified locksmith.
- Cylinder designs vary. HOPPE supplies CES brand cylinders and non-logo cylinders.
- Cylinders feature Schlage<sup>®</sup> SC1 keyways and may be rekeyed using Schlage<sup>®</sup> rekey kits.
- Cylinders should be rekeyed to an existing Schlage<sup>®</sup> key whenever possible.
- The HOPPE key gauge measures key cuts 1 through 9 the same as a Schlage<sup>®</sup> key gauge.

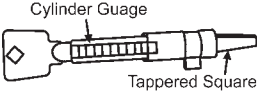
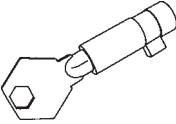

- When rekeying a CES cylinder using CES pins, use the CES pin number that corresponds with the measured key cut.
- When rekeying a CES cylinder using Schlage<sup>®</sup> pins, use the Schlage<sup>®</sup> pin number that is one less than the measured key cut. A key cut measuring 4 uses a #3 Schlage<sup>®</sup> pin.
- When rekeying a non-logo cylinder using CES pins, use the CES pin number that is one higher than the measured key cut. A key cut measuring 4 uses a #5 CES pin.
- When rekeying a non-logo cylinder using Schlage<sup>®</sup> pins, use the Schlage<sup>®</sup> pin number that corresponds with the measured key cut.

										
<table border="1"> <thead> <tr> <th>Part #</th> <th>Description</th> </tr> </thead> <tbody> <tr> <td>850-8773863</td> <td>50mm</td> </tr> <tr> <td>850-2406936</td> <td>60mm</td> </tr> </tbody> </table>	Part #	Description	850-8773863	50mm	850-2406936	60mm	<p><b>850-8785231</b> Key Blanks - Schlage<sup>®</sup> 5-Pin</p>	<p><b>850-8750635</b> Construction Key with Cylinder Gauge. Long Version (Blue)</p>	<p><b>850-2667482</b> Construction Key Short Version (Black)</p>	<p><b>850-2426890</b> 8mm Square Construction Key</p>
Part #	Description									
850-8773863	50mm									
850-2406936	60mm									
Stainless Steel Cylinder Screws										

**Steps to Rekey CES Cylinder with Plastic Insert**

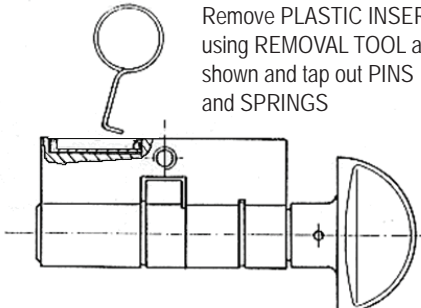
**1.** Remove PLASTIC INSERT using REMOVAL TOOL as shown and tap out PINS and SPRINGS

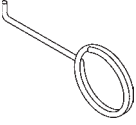
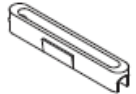



								
<b>850-2000899</b> Removal Tool	<b>850-8771719</b> Plastic Insert	<table border="1"> <thead> <tr> <th>Part #</th> <th>Description</th> </tr> </thead> <tbody> <tr> <td>850-8785239</td> <td>Standard - 100 cylinder capacity</td> </tr> <tr> <td>850-8785243</td> <td>Mini-Kit - 10 cylinder capacity</td> </tr> </tbody> </table> <p>Contains CES Pins</p>	Part #	Description	850-8785239	Standard - 100 cylinder capacity	850-8785243	Mini-Kit - 10 cylinder capacity
Part #	Description							
850-8785239	Standard - 100 cylinder capacity							
850-8785243	Mini-Kit - 10 cylinder capacity							

**Steps to Rekey HOPPE Cylinder with Set Screws**

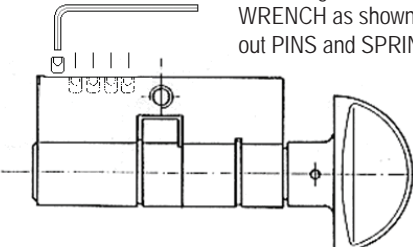
**1.** Remove one SET SCREW at a time using 2 mm HEX WRENCH as shown and tap out PINS and SPRINGS







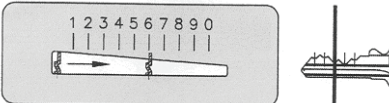

		
<b>850-3475773</b> Set Screw	<b>850-8762427</b> 2mm Hex Wrench	<b>850-3459001</b> 30 cylinder capacity Key Kit Contains Schlage <sup>®</sup> Pins

**2.** **850-2070820**  
HOPPE Key Gauge

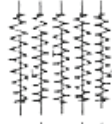
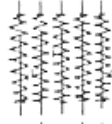

Determine CORE PIN size with KEYING GAUGE

- 3.**
- Insert desired CORE PIN into the appropriate cylinder pin hole.
    - Note: For cylinder designs featuring six pin holes, the innermost hole (furthest from the key face) is left blank.
  - Insert HOUSING PIN
  - Insert SPRING
  - Repeat until all PINS have been replaced and install PLASTIC INSERT OR install SET SCREW and repeat until all PINS have been replaced.

PLASTIC PLUG			SET SCREWS
SPRINGS			SPRINGS
HOUSING (TOP) PINS		<b>OR</b>	HOUSING (TOP) PINS
CORE (BOTTOM) PINS			CORE (BOTTOM) PINS

## Profile Cylinder 90° to 360° Conversion Instructions\*



### Recommended Tools and Accessories



90° RELEASE TOOL  
(provided)



2 mm or 5/64" HEX  
WRENCH  
(provided)

1. Remove the set screw as shown using the hex wrench.



2. Dump out the spring and pin after removing the set screw.



3. Use the 90 degree release tool if the pin does not fall freely from the cylinder body in step 2 as shown.



4. Recycle the set screw, spring, pin, and 90 degree release tool.



\* For the new non-logo cylinders.  
Does not work on CES cylinders.

All HOPPE® Cylinders are available in Full and Thumbturn Insert Sizes. For instructions on converting cylinders from 90° to 360° contact your account manager.



90° Full Cylinder with Crescent Knob  
For 1-3/4" Doors

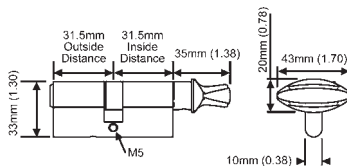

Part #	Finish
850-3142637	Resista Polished Brass
850-3141933	Antique Brass
850-3141925	Resista Polished Chrome
850-3141909	Resista Brushed Chrome
850-3141984	Matte Black
850-3141941	Oil Rubbed Brass
850-3141917	Resista Satin Nickel
850-3142629	Resista Antique Nickel
850-3141968	Rustic Umber
850-3141976	White



90° Thumbturn Insert Cylinder w/Crescent Knob  
For 1-3/4" Doors

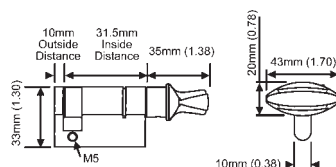

Part #	Finish
850-3142611	Resista Polished Brass
850-3141853	Antique Brass
850-3141845	Resista Polished Chrome
850-3141829	Resista Brushed Chrome
850-3141861	Oil Rubbed Brass
850-3141837	Resista Satin Nickel
850-3141870	Rustic Umber

**HTL ULTIMATE 2-D HINGE**

Steel Reinforcements – Makes this new hinge the “Ultimate” with door systems.

- Corrosion Resistant – Specially coated components for improved durability and strength.
- Easy Adjustment Set hinge has a vertical adjustment feature (+/- 2.5mm) Guide hinge has a horizontal adjustment feature (+/- 2mm).
- Maintenance Free Bearings – No oiling required.
- Security – Non-removable pin (NRP) available for increased security.

- Simple Door Preparation – Quick and easy one pass routing.
- Variety of Finishes – Available in finishes to match your HOPPE® handle sets.
- Designed to carry up to 165lbs. per door.
- Not to be used in commercial applications, especially not in conjunction with a door closer.

**Set Hinge**

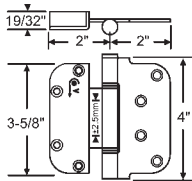

**Steel Set Hinges with Non-Removable Pin**

Part #	Finish
850-8762439	Polished Brass
850-8762455	Polished Chrome
850-8762703	Brushed Chrome
850-2307831	Rustic Umber
850-8762535	Matte Black

**Brass Set Hinges with Non-Removable Pin**

Part #	Finish
850-8762655	Polished Brass
850-8762671	Antique Brass

**Stainless Steel Set Hinges with Non-Removable Pin**

Part #
850-8762567

**Guide Hinge**

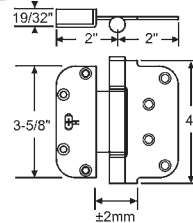

**Steel Guide Hinges with Removable Pin**

Part #	Finish
850-8762435	Polished Brass
850-8762451	Polished Chrome
850-8762699	Brushed Chrome
850-2307823	Rustic Umber
850-8762531	Matte Black

**Brass Guide Hinges with Removable Pin**

Part #	Finish
850-8762651	Polished Brass
850-8762667	Antique Brass

**Stainless Steel Guide Hinges with Removable Pin**

Part #
850-8762563

**2D HINGE FOR WOOD AND VINYL PRODUCTS**

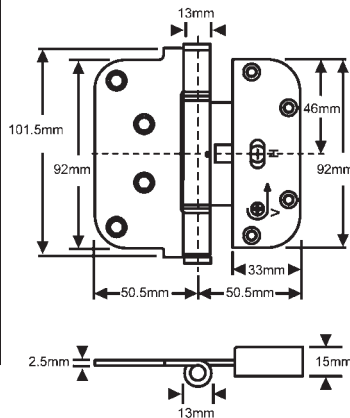

**850-8755047**

Set Hinge

KTL Brass Alternative

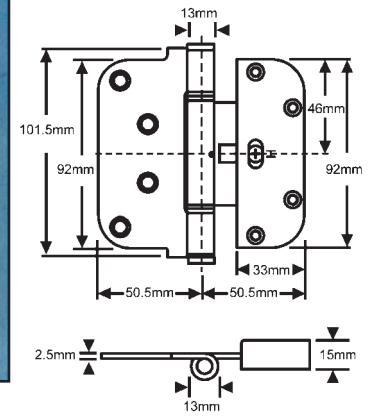

**850-8755099**

Guide Hinge

KTL Brass Alternative

Settling of walls and floors can make door panels hard to open and close. The 2D Adjustable Hinge allows easy adjustment of the door both horizontally (+/- 2 mm) and vertically (+/- 3 mm) with just the turn of a screw. Each hinge is reversible and has maintenance free bearings.

There are two types of adjustable hinges for each door panel.

- Set Hinge: One per panel. This has vertical adjustment (± 3mm).
- Guide Hinge: Minimum of two per panel. These hinges only have the horizontal adjustment (± 2mm.)

The guide hinges float up and down with the adjustment of the set hinge to prevent hinge binding.

Normal hinge replacement has the set hinge. Using a Phillips screwdriver, first adjust the panel up or down by turning the screw marked “V” on the set hinge. When turning the screw in the direction of the arrow (counter clockwise) the other leaf will be pushed in the direction of the arrow. Automatic screwdrivers are not recommended. The speed of the gun may strip the heads if the screws are over adjusted.

When the vertical adjustment is turned clockwise, the non-adjustable leaf will move in the direction of the arrow. The vertical adjustment has 32 turns from it’s extremes, and the horizontal has 7 turns.

Adjust the horizontal by turning clockwise to increase the margins. Turn counter clockwise to decrease the margins.



## HOPPE ADJUSTABLE HINGE



### Designed for a Greater Advantage.

- Adjusts both vertically (Set Hinge) and horizontally (Guide Hinge) by 1/8" for a perfect swing.
- Brass hinges feature finial caps as shown
- Aluminum hinges feature flush caps.
- Large 3/16" hex head screws make adjustments effortless. Remove the finial in the set hinge to access the hex screw.
- Single pass routing for quick and easy installation.
- All Set and Guide Hinges are equipped with non-removable pins for security, making HOPPE Adjustable Hinges the ideal solution for both inswing and outswing doors.
- Especially designed for larger doors, with a panel weight capacity of up to 330 lbs.

### Tested to a Higher Standard.

- Brass hinges are tested beyond an impressive 2.5 million cycles, in accordance with ANSI A156.1 Grade 1 – Commercial test procedures.
- Backed by HOPPE's Limited Lifetime Mechanical Warranty.

### Finished with Superior Quality.

HOPPE's Brass and Aluminum Hinges are outstanding corrosion resistant materials. HOPPE uses their Resista® Limited Lifetime Finish Warranty on four of their select premium finishes. The Aluminum Hinges have a high quality powder coating finish.

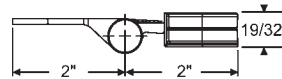
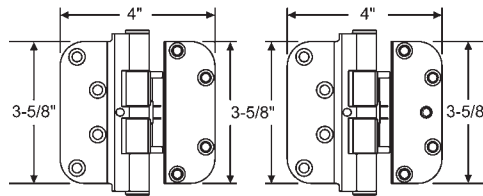

Brass Guide Hinges

F41-R Brushed Chrome Resista® 850-2664581	F42-R Satin Nickel Resista® 850-2664572	F49-R Polished Chrome Resista® 850-2664556	F77-R Polished Brass Resista® 850-2664601	F73 Antique Brass 850-2659562	F79 Oil Rubbed Brass 850-2664599
--	--	---	--	----------------------------------	-------------------------------------

Brass LH Set Hinges

F41-R Brushed Chrome Resista® 850-2972364	F42-R Satin Nickel Resista® 850-2972410	F49-R Polished Chrome Resista® 850-2972372	F77-R Polished Brass Resista® 850-3113431	F73 Antique Brass 850-2972399	F79 Oil Rubbed Brass 850-2972401
--	--	---	--	----------------------------------	-------------------------------------

Brass RH Set Hinges

F41-R Brushed Chrome Resista® 850-2972655	F42-R Satin Nickel Resista® 850-2972743	F49-R Polished Chrome Resista® 850-2972680	F77-R Polished Brass Resista® 850-3113529	F73 Antique Brass 850-2972701	F79 Oil Rubbed Brass 850-2972719
--	--	---	--	----------------------------------	-------------------------------------

Aluminum Guide Hinges

F1713 Gold 850-3033852	F8709 Rustic Umber 850-3052105	F 9010 Pure White 850-3033861	F7914 Matte Black 850-3033879
---------------------------	-----------------------------------	----------------------------------	----------------------------------

Aluminum LH Set Hinges

F1713 Gold 850-3033924	F8709 Rustic Umber 850-3052201	F 9010 Pure White 850-3033941	F7914 Matte Black 850-3033967
---------------------------	-----------------------------------	----------------------------------	----------------------------------

Aluminum RH Set Hinges

F1713 Gold 850-3033916	F8709 Rustic Umber 850-3052156	F 9010 Pure White 850-3033932	F7914 Matte Black 850-3033959
---------------------------	-----------------------------------	----------------------------------	----------------------------------



### Handing of Door

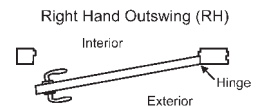
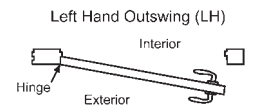

## MILLENNIUM HINGES

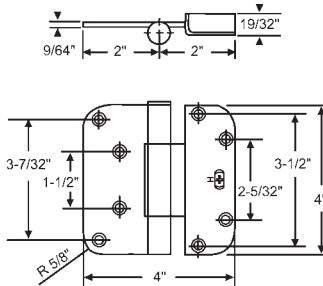

2D Guide Hinge with Removable Pin

Part #	Finish
850-8754731	Brushed Chrome
850-2388854	Antique Brass
850-8754727	Brass Alternative (KTL Finish)
850-8754743	Stainless Steel

**WEATHERSHIELD/PEACHTREE**

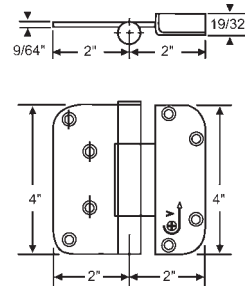

2D Set Hinge with Non-Removable Pin

Part #	Finish
850-8754807	Brushed Chrome
850-2388803	Antique Brass
850-8754803	Brass Alternative (KTL Finish)
850-8754819	Stainless Steel
850-8754815	Oil Rubbed Bronze

**WEATHERSHIELD/PEACHTREE**

## HLS 9000 MULTI-POINT HARDWARE SWING DOOR QUESTIONNAIRE

This form is for a HOPPE or FUHR Swing Door Multi-Point System with the key cylinder below the lever handle.

The HLS9000 Stainless Steel Multi-Point Locking System provides more than safety and security. It prevents the unwelcome intrusion of rust and corrosion. It can also keep your reputation from being tarnished by eliminating expensive service calls and any resulting loss of revenue.

Corrosion occurs for a variety of reasons. With other materials or finishes, such as yellow zinc dichromate, it can result from pollution in the air, a scratched surface or from the presence of moisture or salt - particularly in coastal regions. Stainless Steel provides excellent corrosion resistance from these in natural atmospheric conditions. It also provides an extra measure of protection from pitting and staining in more demanding locations such as industrial sites, areas of urban pollution and coastal regions. So to protect the quality of your product as well as your image, insist upon HLS9000.



Manual Tongue/  
Shootbolt Version

Automatic Four  
Roller Version



SWING  
HOOK



SHOOTBOLT  
VERSION



ROLLER  
VERSION



TONGUE  
VERSION



ROUNDBOLT  
VERSION

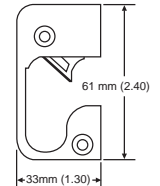
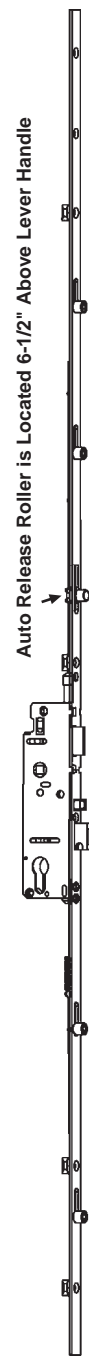
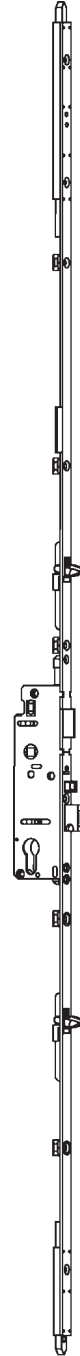

Auto Release Strike

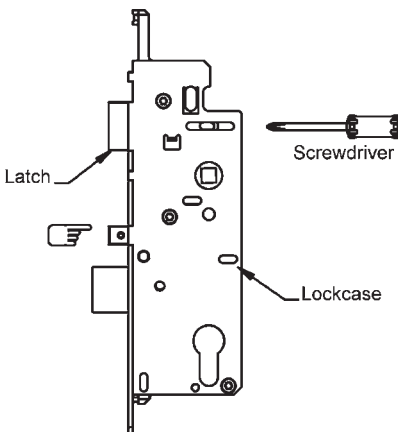

**Reversing Latch**

1. Push small screwdriver or punch into reversing hole and push latch up until latch clears lockcase.
2. Rotate latch 180° and release back into lockcase.

**Reversing Mishandling Device**

1. Rotate latch 180° with hand and release back into lockcase.



Reversing hole as viewed from back of lockcase.

1. The HOPPE® Multi-Point Locking Systems are in **most cases** a direct replacement for FUHR Multi-Point Systems.
2. There are various sizes and combinations of these multi-point locking systems. Please fill out the questionnaire and fax it to our sales office to obtain part numbers, pricing and availability.

**General Information**

- A) If you have a HOPPE or FUHR Sliding Door Multi-Point System, fill out the **Old FUHR Sliding Door Multi-Point Questionnaire**.
- B) If you have a HOPPE Swing Door Multi-Point System with the key cylinder above the lever handle, fill out form for the **HLS 7 Series**.
- C) If you have a HOPPE or FUHR Swing Door Multi-Point System with the key cylinder below the lever handle, fill out the form for the **HLS 9000 Series**

**#8 Mounting Screws 2 Per Pack**

	3/4" Long	1-1/2" Long	Finish	3/4" Long	1-1/2" Long	Finish
	850-2100785	850-2104381	Polished Brass/ Brushed Brass	850-2100814	850-2104410	Polished Chrome/ Brushed Stainless Steel
	850-2100793	850-2104399	Antique Brass	850-2100822	850-2104428	Oil Rubbed Brass/ Matte Black
	850-2100831	850-2104436	Brushed Chrome/ Satin Nickel	850-2100849	850-2104444	Antique Nickel

## Single Point Mortise Locks

## Latch & Deadbolt Strike

## Dust Cap

Part #	Backset	Deadbolt Throw
850-8778179	1-3/8"	1/2"
850-8778175	1-3/4"	1/2"
850-8778151	1-3/8"	1"
850-8777959	1-3/4"	1"
850-2881323	2-3/8"	1"
850-2881331	2-3/4"	1"

Stainless Steel

**For 1-3/4" Door**

Part #	Finish
850-8787715	Polished Brass
850-8787719	Antique Brass
850-8787735	Matte Black
850-8787723	Polished Chrome
850-8787727	Brushed Chrome
850-8787731	Oil Rubbed Brass
850-8787739	White Powder Coat
850-8787747	Stainless Steel
850-2127443	Satin Nickel
850-2127427	Antique Nickel

Curved Lip with Cylinder Hole and Non-Handed  
Other Configurations Available

**For 2-1/4" Door**

Part #	Finish
850-2014019	Polished Brass
850-2014027	Stainless Brass
850-2014334	Oil Rubbed Brass
850-2014764	Brushed Chrome
850-2014781	Polished Chrome
850-2014799	White Powder Coat
850-2014801	Matte Black Powder Coat
850-3772612	Rustic Umber

Curved Lip with Cylinder Hole and Non-Handed  
Other Configurations Available

Part #	Finish
850-8786547	Black

For Latch and Deadbolt Strike  
and Tongue Strike

**Roller Strike Plate**

Part #	Finish
850-8785003	Brass
850-8784999	Chrome
850-8784991	Oil Rubbed Brass
850-8784995	Raw, Unplated

## Tongue Strikes

## Shootbolt Strikes

Part #	Finish
850-8784675	Brass
850-1964522	Stainless Steel
850-2121244	Oil Rubbed Brass

Curved Lip

Part #	Finish
850-2025181	Brass
850-2025199	Stainless Steel
850-2025842	Oil Rubbed Brass

Radius Lip

Part #	Finish
850-8784699	Brass
850-8784707	Stainless Steel
850-8786551	Antique Brass
850-8786559	Brushed Chrome
850-8784703	Oil Rubbed Brass
850-8786575	Matte Black
850-2127486	Satin Nickel

Flat

Part #	Hand	Finish
850-8784091	LH	Stainless Steel
850-2117325	LH	Oil Rubbed Brass
850-8784067	RH	Brass
850-8783923	RH	Stainless Steel
850-2117261	RH	Oil Rubbed Brass

Curved Lip Single Door

Part #	Finish
850-8784047	Stainless Steel

Part #	Finish
850-2135259	Brass
850-2098911	Stainless Steel

Single Door

## Shootbolt Strikes

## Socket Strikes

## Auto-Release Strike & Plates for Automatic Systems

Part #	Finish
850-2135241	Brass
850-2098945	Stainless Steel

Double Door

Part #	Finish
850-8784663	Brass
850-8784667	Oil Rubbed Brass

3/4" Throw

Part #	Finish
850-2024962	Brass

1" Throw

Strike Part #	Underplate Part #	Finish
850-8783867	850-8784775	Brass
850-8783871	850-8784783	Stainless
850-8783875	850-8784779	Oil Rub

**HLS 9000 MULTI-POINT HARDWARE SWING DOOR QUESTIONNAIRE**

This form is for a HOPPE or FUHR Swing Door Multi-Point System with the key cylinder below the lever handle.

**Customer Name:** \_\_\_\_\_ **Account Number** \_\_\_\_\_

**Contact:** \_\_\_\_\_ **Phone Number** \_\_\_\_\_

1. Which do you see stamped on the thin edge of the metal face plate running up the entire door edge:  
"FUHR" or "HOPPE®"? (This can be found in between the door latch and deadbolt area) \_\_\_\_\_
2. What is the **finish** of the faceplate?  Brass looking  Stainless Steel
3. Do you know who manufactured the door? How about the windows in your home? If so, please list the company:  
\_\_\_\_\_
4. Is this for a single door or a pair of doors (french doors)? \_\_\_\_\_
5. What is the door thickness:  1-3/4" (45mm)  2-1/4" (57.15mm)  Other: \_\_\_\_\_
6. Is this a "**manual**" or "**automatic**" system? Manual: Pull up on handle to engage the multipoint locks. Automatic: Where the multi point locks engage on their own when you close the door.  **Manual**  **Automatic\***

**\*NOTE: Automatic version will have a small roller-like piece located 6-1/2" above the latch. See pictures.**

- 6A. If you have a FUHR Automatic System what finish is your auto-release strike \_\_\_\_\_
7. Based on the accompanying pictures, please put an "x" by the multipoint system you have:
 

<input type="checkbox"/> Automatic Tongue* (3-Point System)	<input type="checkbox"/> Manual Roller with Shootbolt (5-Point System)
<input type="checkbox"/> Manual Tongue (3-Point System)	<input type="checkbox"/> Manual Roundbolt (3-Point System)
<input type="checkbox"/> Automatic Roller* (3-Point System)	<input type="checkbox"/> Manual Roundbolt with Shootbolt (5-Point System)
<input type="checkbox"/> Manual Roller (3-Point System)	<input type="checkbox"/> Manual Swing Hook (3-Point System)
<input type="checkbox"/> Automatic 4-Roller (5-Point System)	<input type="checkbox"/> Manual Swing Hook (4-Point System)
<input type="checkbox"/> Manual 4-Roller (5-Point System)	<input type="checkbox"/> Manual Shootbolt (3-Point System for Active Door)
<input type="checkbox"/> Manual Tongue with Shootbolt (5-Point System)	<input type="checkbox"/> Manual Shootbolt (2-Point System for Inactive Door)

**\*NOTE: When replacing an old FUHR automatic systems, the Hoppe automatic release roller will be in a different location. Please contact your account manager for re-routing instructions.**

8. **FACE PLATE WIDTH:** The metal plate that runs the length of the door:  5/8" (16mm)  25/32" (20mm)
9. What is the total height of the door? : \_\_\_\_\_
10. If you have a tongue, roundbolt or roller version, what is the distance from the center of the handle to the **top** position of tongue, roundbolt or roller? (Note: All measurements shown are taken when system is in the locked position)
 

**Tongue:**  23-5/8" (600mm)  29-1/4" (743mm)  37-13/64" (945mm)  41-11/32" (1050mm)  46-31/32" (1193mm)  62-3/4" (1594mm)  
 Other \_\_\_\_\_

**Roubolt:**  23-5/8" (600mm)  32-1/8" (816mm)  40" (1016mm)  41-11/32" (1050mm)  47-7/8" (1216mm)  59-1/16" (1500mm)  
 63" (1600mm)  Other \_\_\_\_\_

**Two Roller:**  13" (330mm)  23-5/8" (600mm)  25-5/8" (651mm)  28-3/4" (730mm)  32-5/8" (829mm)  36-5/8" (930mm)  
 41-11/32" (1050mm)  44-11/16" (1050mm)  50-19/32" (1285mm)  59" (1500mm)  63" (1600mm)  Other \_\_\_\_\_

**Four Roller - Position #1:**  15-3/4" (400mm)  23-5/8" (600mm)  31-1/2" (800mm)  39-3/8" (1000mm)  Other \_\_\_\_\_

**Four Roller - Position #2:**  31-1/2" (800mm)  45-1/4" (1150mm)  59" (1500mm)  72-53/64" (1850mm)  Other \_\_\_\_\_

**Swing Hook - Position #1:**  19-11/16" (500mm)  23-5/8" (620mm)  35-7/16" (900mm)  Other \_\_\_\_\_
11. **SHOOTBOLT THROW:** Full extension of shootbolt:  25/32" (20mm - Standard)  1" (25mm - Available on inactive systems only)
12. **HANDLE HEIGHT:** The distance from the center of the door handle down to the bottom horizontal edge of the door (36" Standard)? \_\_\_\_\_
13. What is the distance from the center of the handle to the center of the thumbturn piece?  
 2-7/32" (56mm)  2-53/64" (72mm)  3-5/8" (92mm - Standard)  Other: \_\_\_\_\_
14. **BACKSET:** What is the distance from the center of the handle to the door edge (edge with the latch and deadbolt on it)?  
 1-3/8" (35mm)  1-3/4" (45mm)  2-3/8" (60mm)  2-3/4" (70mm)
15. **DEADBOLT THROW:** With the door ajar, measure how far out the deadbolt extends from the edge of the door:  1/2"  1"
16. If you have a tongue, roundbolt or roller version, what is the distance from the center of the handle down to the **bottom** position of tongue, roundbolt or roller? (Note: All measurements shown are taken when system is in the locked position)
 

**Tongue:**  24-13/32" (620mm)  26-27/64" (671mm)  29-21/32" (753mm)  Other: \_\_\_\_\_

**Roubolt:**  24-13/32" (620mm)  26-19/64" (668mm)  Other: \_\_\_\_\_

**Two Roller:**  24-13/32" (620mm)  29-1/2" (750mm)  Other \_\_\_\_\_

**Four Roller - Position #1:**  15-3/4"  Other \_\_\_\_\_

**Four Roller - Position #2:**  29-1/2" (750mm)  Other \_\_\_\_\_

**Swing Hook:**  29-21/32" (753mm)  Other \_\_\_\_\_

## HLS 7 SERIES MULTI-POINT HARDWARE SWING DOOR QUESTIONNAIRE

This form is for a HOPPE Swing Door Multi-Point System with the key cylinder above the lever handle.

Customer Name: \_\_\_\_\_ Account Number \_\_\_\_\_

Contact: \_\_\_\_\_ Phone Number \_\_\_\_\_

1. HOPPE will be stamped below the latch on the thin metal faceplate that runs along the edge of the door
2. Do you know who manufactured the door? How about the windows in your home? If so, please list the company: \_\_\_\_\_
3. Is this for a single door or a pair of doors (french doors)? \_\_\_\_\_  
If pair of doors, what is the thickness of the astragal on the inactive door?  Flush  19/32" to 3/4"  3/4" to 29/32"  29/32" to 1"  1" to 1-9/64"
4. What is the door thickness:  1-3/4" (45mm)  2-1/4" (57.15mm)  Other: \_\_\_\_\_
5. Based on the pictures shown below, please put an "X" by your HLS7 Manual Multi-Point System

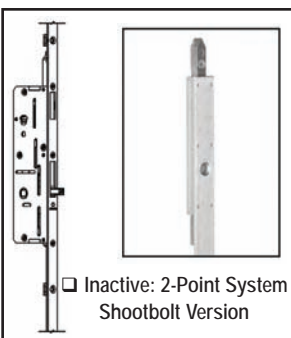
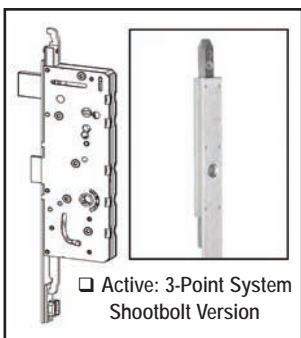
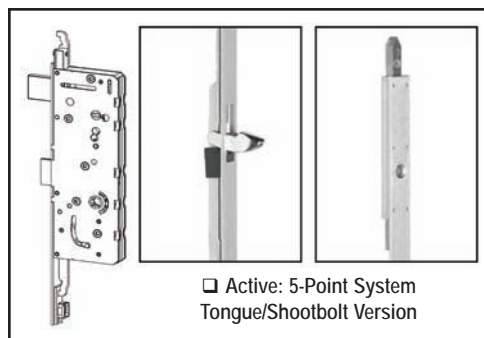
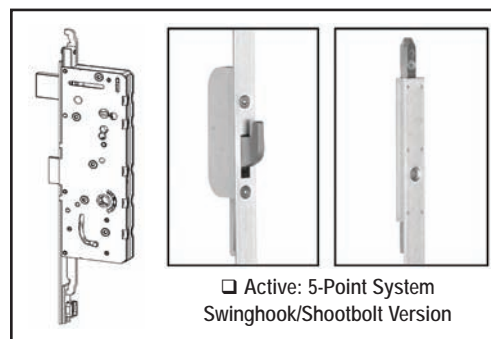
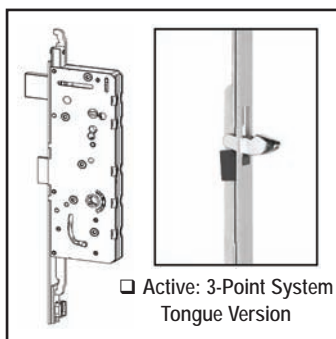
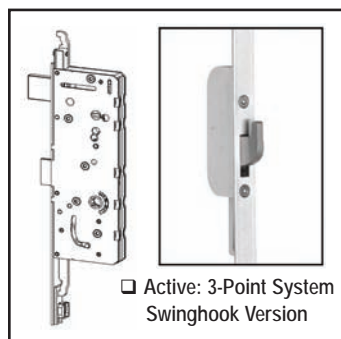

6. The metal face plate for all HLS 7 Systems is 5/8" (16mm) wide and is made of stainless steel.
7. The shootbolt throw for all HLS 7 Systems is 1" (25mm).
8. What is the total height of the door panel?: \_\_\_\_\_
9. Is your door right hand or left hand?  RH  LH  
**NOTE:** Door handing is determined from the exterior. When hinges are on the left, the door is LH. When hinges are on the right, the door is RH. (Inswing or Outswing does not determine handing)
10. If you have a tongue or swinghook version, what is the distance from the center of the handle up to the top tongue or swinghook position?  
 15-3/4" (400mm)  23-5/8" (600mm)  29-1/4" (743mm)  37-13/64" (945mm)  40-7/16" (1026.8mm)  46-31/32" (1193mm)  59" (1500mm)
11. The handle height for all HLS 7 Systems is 36".
12. The distance from the center of the handle to the center of the thumbturn piece for all HOPPE systems is 3-5/8" (92mm).
13. Backset for all HLS 7 Systems is 1-3/4" (45mm).
14. The deadbolt throw for all HLS 7 Systems is 1" (25mm).
15. If you have a tongue or swinghook version, what is the distance from the center of the handle down to the bottom tongue or swinghook position?  
 24-13/32" (620mm)  29-21/32" (753mm)

## MULTI-POINT HARDWARE SWING DOOR QUESTIONNAIRE

Acct. #: \_\_\_\_\_ Date: \_\_\_\_\_  
 Customer Name: \_\_\_\_\_ Phone: \_\_\_\_\_  
 Address: \_\_\_\_\_ Fax: \_\_\_\_\_  
 \_\_\_\_\_ E-mail: \_\_\_\_\_

1. Is the faceplate stamped with **G-U** or **Ferco**?  G-U  Ferco  Other: \_\_\_\_\_
2. Is this for a single door, or a pair of doors (french doors)? \_\_\_\_\_
3. What is the door thickness?  1-3/4" (45mm)  2-1/4" (57mm)  Other: \_\_\_\_\_
4. Do you know who manufactured your door? Do you know the age of your door? \_\_\_\_\_
5. What is the finish/color of your Multipoint system?  
 Silver  Stainless Steel  Yellow Dichromate (Brass looking)  Black Matte  White
6. What is the distance from the **center** of the handle to the **center** of the key cylinder?  
 2-7/32" (56mm)  2-53/64" (72mm)  3-5/8" (92mm - Standard)  Other: \_\_\_\_\_
7. Is this a "**Manual**" (locks are engaged by lifting lever upwards) or "**Automatic**" (locks engage automatically when you close the door) system?  Manual  Automatic
8. What is the width across of this metal face plate?  5/8" (16mm)  25/32" (20mm)
9. Is the key cylinder located **above** (American Version) or **below** (European Version) the handle? \_\_\_\_\_
10. Based on the locking options on page 341, please put an "X" by the name of your G-U Multipoint System:

### American Version (Key Above Handle)

- Wolverine:** Manual 3-point locking system (Active Door).  
Top & Bottom Shootbolt and Deadbolt.
- Wolverine:** Manual 2-point locking system (Inactive Door).  
Top & Bottom Shootbolt.
- Eagle:** Automatic 3-point locking system.  
2 Additional Latches and Deadbolt.
- Hawk:** Semi-Automatic 3-point locking system.  
2 Additional Latches and Deadbolt.
- Other: \_\_\_\_\_

### European Version (Key Below Handle)

- Cremona:** Manual 3-point locking system (Active Door).  
Top & Bottom Shootbolt with Latch and Deadbolt.
- Cremona/Europa:** Manual 2-point locking system (Inactive Door).  
Top & Bottom Shootbolt without Latch and Deadbolt.
- Rhino:** Manual 3-point locking system.  
2 Horn Type Bolts and Deadbolt.
- Rhino:** Manual 5-point locking system.  
2 Horn Type Bolts, Top & Bottom Shootbolt and Deadbolt.
- Tripact:** Manual 3-point locking system.  
2 Hook/Tongue bolts and Deadbolt.
- Tripact/Cremona:** Manual 5-point locking system.  
2 Hook/Tongue Bolts, Top & Bottom Shootbolt and Deadbolt.
- Europa R2:** Manual 5-point locking system.  
2 Rollers, Top & Bottom Shootbolt and Deadbolt.
- Other: \_\_\_\_\_

Refer to measuring guidelines on page 341 to answer questions below

11. **BACKSET:** What is the distance from the **center** of the handle to the door **edge** (edge with the latch and deadbolt on it)?  
 1-3/16" (30mm)  1-3/8" (35mm)  1-9/16" (40mm)  1-3/4" (45mm)  2" (50mm)  2-3/16" (55mm)  2-3/8" (60mm)
12. Does the teardrop on your mortise gear box take a full cylinder or is there an insert in the round part of the teardrop that accepts a tailpiece to engage the deadbolt?  Full Cylinder  Insert that accepts a tailpiece (See picture of single point locks on page 12)
13. **DEADBOLT THROW:** The throw on the deadbolt is 1" (25mm)
14. **HANDLE HEIGHT:** The distance from the **center** of the door handle down to the **bottom edge** of the door (35" Standard)? \_\_\_\_\_
15. **BOTTOM LOCK POSITION:** What is the distance of the **bottom lock** to the **bottom edge** of the door? \_\_\_\_\_
16. What is door panel height (The door panel is the part that opens and closes)? \_\_\_\_\_
17. **TOP LOCK POSITION:** What is the distance of the **top lock** to the **bottom edge** of the door? \_\_\_\_\_

## LOCKING OPTIONS FOR MULTIPOINT QUESTIONNAIRE

### Locking Options

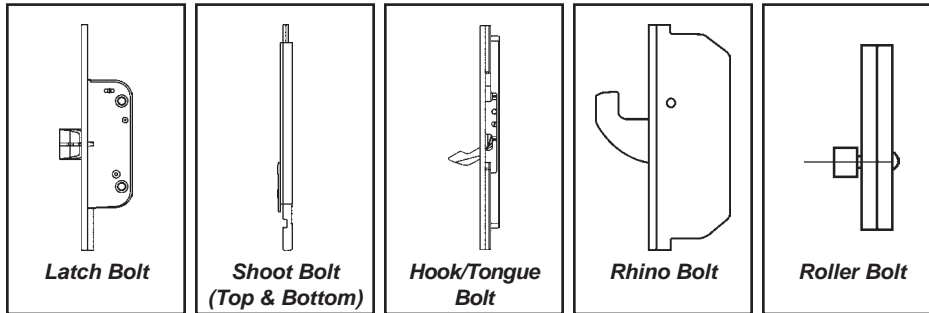

### Measuring Guidelines

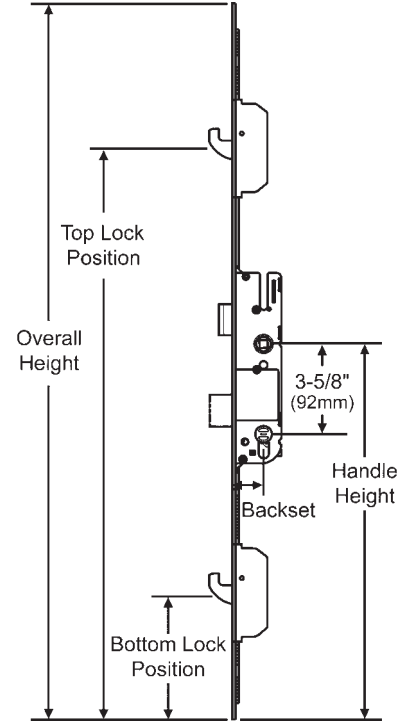

## SINGLE POINT MORTISE LOCKS

### Key Cylinder Below Handle

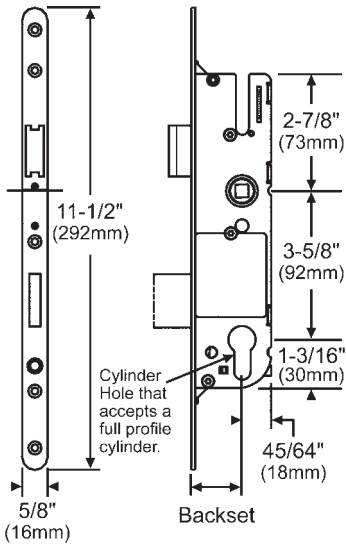

Part Number	Backset
854-15559	30mm
854-15492	35mm
854-15560	40mm
854-15561	45mm
854-15488	50mm
854-15552	55mm

Stainless Steel

### Key Cylinder Below Handle

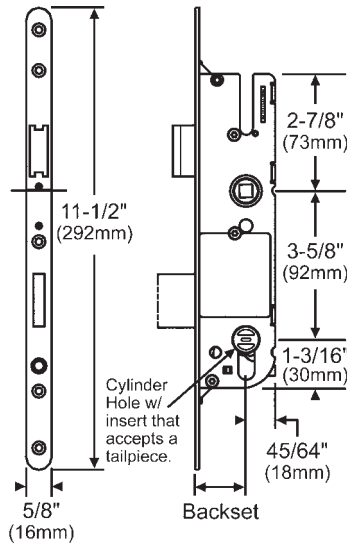

Part Number	Backset
854-15562	30mm
854-11113	35mm
854-15284	40mm
854-15563	45mm
854-15489	50mm
854-15551	55mm

Stainless Steel

### Key Cylinder Above Handle

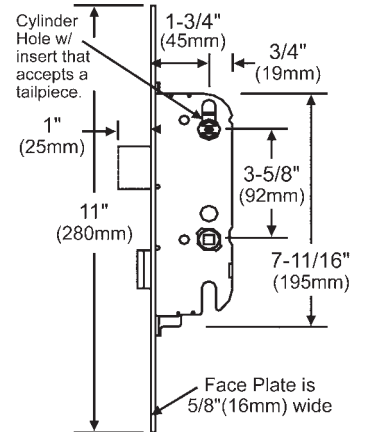

Part Number	Backset
854-10549	45mm

Stainless Steel

## MULTI-POINT HARDWARE SWING DOOR QUESTIONNAIRE

Acct. #: \_\_\_\_\_ Date: \_\_\_\_\_  
 Customer Name: \_\_\_\_\_ Phone: \_\_\_\_\_  
 Address: \_\_\_\_\_ Fax: \_\_\_\_\_  
 \_\_\_\_\_ E-mail: \_\_\_\_\_

1. Door Type:  Wood  PVC  Fiberglass  Aluminum
2. Door Style:  Single  Double/ French\* (Fill out separate form for each door)  
 \*If door has Astragal, what is the thickness? \_\_\_\_\_
3. Door Thickness: \_\_\_\_\_
4. Hole spacing between handle and key cylinder:  3-5/8" (92mm) Standard  Other
5. The mortise gear box has an insert to accept a tailpiece.
6. **HANDLE HEIGHT:** What is the distance from the center of the handle down to the horizontal edge of the door (36" Standard)? \_\_\_\_\_
7. **BACKSET:** What is the distance from the **center** of the handle to the door **edge** (edge with the latch and deadbolt on it)?  
 1-3/8" (35mm)  1-3/4" (45mm)  2-3/8" (60mm)
8. Faceplate Width:  5/8" (16mm)  25/32" (20mm)
9. Door Panel Height: \_\_\_\_\_
10. Based on the pictures shown below, please put an "X" by your Amesbury Multi-Point System:

American Version (Key Above Handle)

European Version (Key Below Handle)

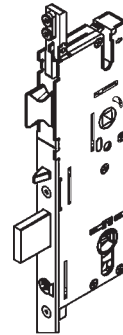
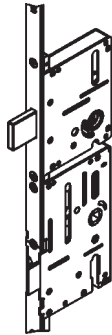

**Active:**  
3-point  
Shootbolt  
Version

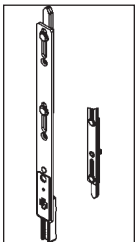

(1) Deadbolt (1" Throw)  
(2) Shootbolts (20mm Throw)

**Active:**  
3-point  
Tongue  
Version



(1) Deadbolt (1" Throw)  
(2) Tongues

**Active:**  
3-point  
Rhino  
Version

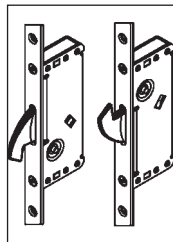

(1) Deadbolt (1" Throw)  
(2) Rhino Hooks

**Active:**  
4-point Rhino/  
Shootbolt  
Version

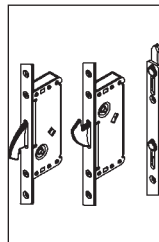

(1) Deadbolt (1" Throw)  
(1) Shootbolts (20mm Throw)  
(2) Rhino Hooks

**Active:**  
5-point Tongue  
/Shootbolt  
Version

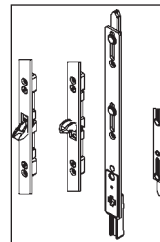

(1) Deadbolt (1" Throw)  
(2) Shootbolts (20mm Throw)  
(2) Tongues

**Active:**  
5-point Rhino/  
Shootbolt  
Version

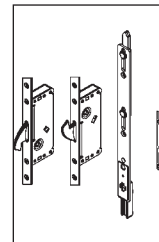

(1) Deadbolt (1" Throw)  
(2) Shootbolts (20mm Throw)  
(2) Rhino Hooks

**Inactive:**  
2-point  
Shootbolt  
Version

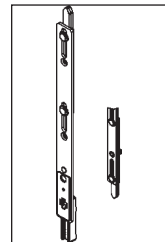

(2) Shootbolts (20mm Throw)

11. Top Tongue Position (measured from the center of the handle to the center of the top tongue):  
 18-59/64" (480.5mm)  26-25/64" (670.4mm)  32-57/64" (835.55mm)
12. Bottom Tongue Position (measured from the center of the handle to the center of the bottom tongue):  
 26-27/64" (671mm)
13. Top Rhino Hook Position (measured from the center of the handle to the center of the top hook):  
 14-15/32" (367.5mm)  27-15/32" (697.7mm)  40-15/32" (1028mm)
14. Bottom Rhino Hook Position (measured from the center of the handle to the center of the bottom hook):  
 24-7/8" (631.7mm)



## SINGLE POINT MORTISE GEAR BOX AND ACCESSORIES

### Latch & Deadbolt Strikes

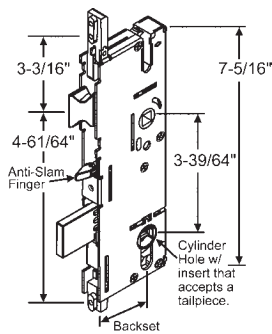

Part Number	Backset
56-243	35mm
56-207	45mm

5/8" Case Width & 1" Deadbolt Throw

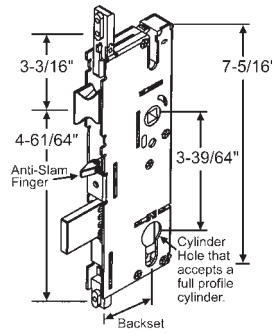

Part Number	Backset
56-244	35mm
56-245	45mm

5/8" Case Width & 1" Deadbolt Throw

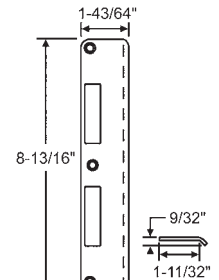

**56-232SS**

Brushed Stainless Steel

### Shootbolt Strikes

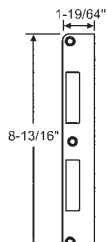

**56-233SS**

Brushed Stainless Steel

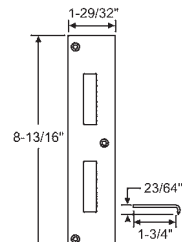

**56-234SS**

Brushed Stainless Steel

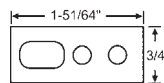

**56-235SS**

Single Shootbolt. Stainless Steel

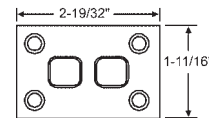

**56-236SS**

Double Shootbolt. Stainless Steel

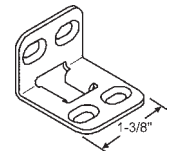

**56-237SS**

Corner Shootbolt. Brushed Stainless Steel

### Tongue Strike

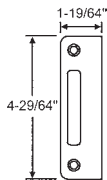

**56-238SS**

Brushed Stainless Steel

### Adjustable Strikes

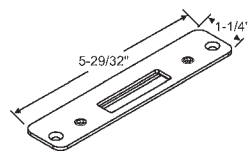

**56-241**

Flat Style. Stainless Steel

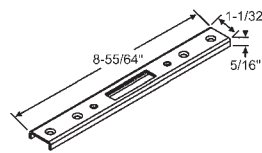

**56-242**

Formed Style. Stainless Steel

### Dust Cap

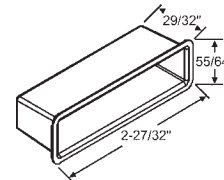

**56-240**

### Spring Cassette

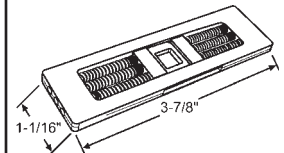

**56-221**

Stainless Steel

## HINGES

### FEATURES AND BENEFITS

- Non-Handed Design Reduces Inventory.
- Both Vertically and Horizontally Adjustable.  
Horizontal Adjustment  $\pm .156$   
Vertical Adjustment  $\pm .200$
- Vertical Adjustment in Each Hinge Allows for Heavier Panels.
- Adjusts with a Standard #2 Square Drive.  
Square Drive Prevents Stripping Over Phillips or Slotted.
- Secure Out-Swing Non-Removable Pin Hinges Available.
- Fits Common Fabrication within the Industry.

Part Number	Finish	Material	Pin
56-155B	Black	Steel	Removable
56-155CRBZ	Craftsman Bronze	Steel	Removable
56-155DOBZ	Dark Oil Rubbed Bronze	Steel	Removable
56-155SNK	Satin Nickel PVD	Steel	Removable
56-440SNK	Satin Nickel PVD	Brass	Removable
56-440PB	Solid Brass PVD	Brass	Removable
56-156B	Black	Steel	Non-Removable
56-156CRBZ	Craftsman Bronze	Steel	Non-Removable
56-156DOBZ	Dark Oil Rubbed Bronze	Steel	Non-Removable
56-440SNK-NRP	Satin Nickel PVD	Brass	Non-Removable
56-440PB-NRP	Solid Brass PVD	Brass	Non-Removable

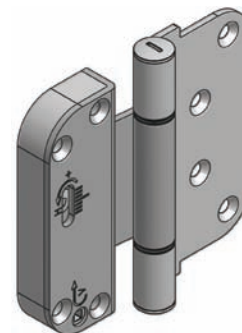
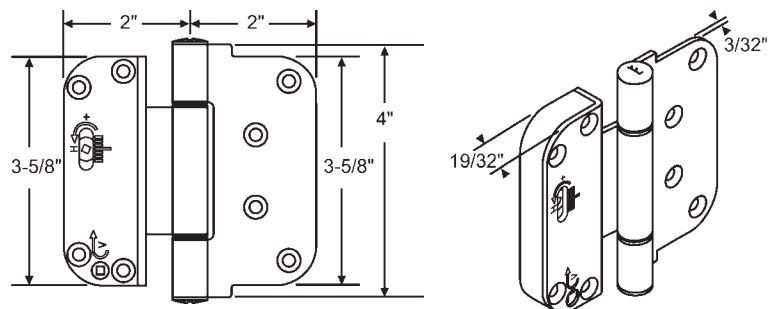

MULTI-POINT LOCK

TRU-LOCK MULTI-POINT LOCK SOLUTION FOR ENTRY DOORS

Convert Your Single Point Dead Bolt into a Multi-Point Locking System



**56-161**

Multi-Point Lock Conversion Kit  
Includes 2 Stainless Steel Strikes,  
Screws & Instructions

- Excellent Retro Fit for Schlage, Kwikset, Wiser
- Increased Home Security – Capable of Grade 40 per ASTM F476
- Compatible with top brand handle hardware allowing consumer wide selection of decorative handle choices
- Very intuitive function for homeowner – operates the same as standard deadbolts today
- Constructed from stainless steel and composite materials
- Works on steel, fiberglass, aluminum and wood doors
- Works with both standard 2-3/8" and 2-3/4" double bore backsets
- Easy installation, instructions included.

Kit Plate Cover

Kit Plate Cover Comes with 2 Strikes, Multi-Point Plate and all necessary Screws

Part #	Finish
56-162	Brass
56-163	Oil Rubbed Bronze

TRU - LOCK FABRICATION TEMPLATE



**56-153**

Tools provided in Amesbury installation kit:

(A) Door router fixture #56-153-1, (B) Door frame router fixture #56-153-2, (C) 1/2" Router bit with top guide bearing, (D) 1/4" Router bit, (E) Centering clamp, (F) 1/4" X 2 1/2" Flathead bolt and 1/4" Wing Nut, (G) Assorted deadbolt strike plugs, (H) Door stops, (I) # 6 x 1 1/4" Flathead screws, (J) # 8 x 1 5/8" Sheetrock screws (K) Wood cover plates

## TRUTH'S SENTRY™ MULTI-POINT HANDLE SETS FOR 1-3/4" THICK DOORS

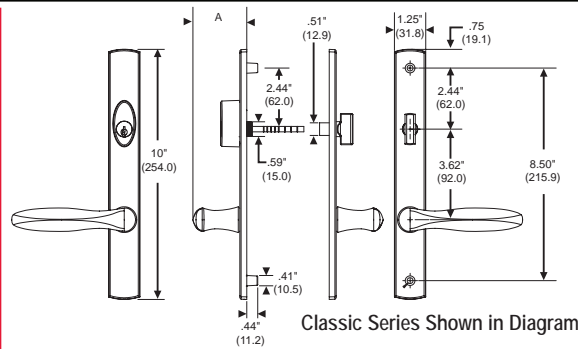

Handle Type	A
Transitional	2.26"
Traditional	2.45"
Contemporary	2.05"
Modern	2.33"
Classic	2.16"

### Finishes



### Handle Styles

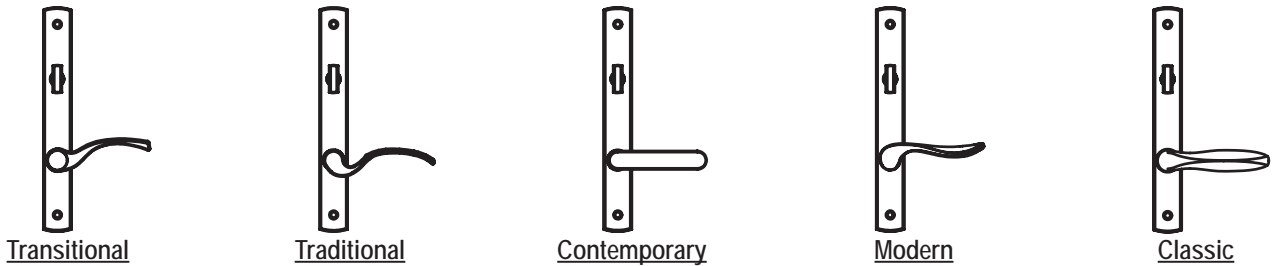

Style	Function	Antique Brass	PVD Brushed Chrome	PVD Chrome	PVD Brass	PVD Bronze	PVD Nickel	Faux Bronze	Black	White	Beige
Transitional	Active	857-10183	857-10213	857-10207	857-10204	857-10210	857-10192	857-10201	857-10198	857-10189	857-10186
	Inactive	857-10182	857-10212	857-10206	857-10203	857-10209	857-10191	857-10200	857-10197	857-10188	857-10185
	Dummy	857-10184	857-10214	857-10208	857-10205	857-10211	857-10193	857-10202	857-10199	857-10190	857-10187
Traditional	Active	857-10216	857-10249	857-10243	857-10240	857-10246	857-10225	857-10235	857-10231	857-10222	857-10219
	Inactive	857-10215	857-10248	857-10242	857-10239	857-10245	857-10224	857-10233	857-10230	857-10221	857-10218
	Dummy	857-10217	857-10250	857-10244	857-10241	857-10247	857-10226	857-10237	857-10232	857-10223	857-10220
Contemporary	Active	857-10252	857-10279	857-10273	857-10270	857-10276	857-10259	857-10016	857-10265	857-10018	857-10255
	Inactive	857-10251	857-10278	857-10272	857-10269	857-10275	857-10258	857-10015	857-10264	857-10017	857-10254
	Dummy	857-10253	857-10280	857-10274	857-10271	857-10277	857-10260	857-10268	857-10266	857-10257	857-10256
Classic	Active	857-10282	857-10314	857-10308	857-10305	857-10311	857-10291	857-10298	857-10020	857-10288	857-10285
	Inactive	857-10281	857-10313	857-10307	857-10304	857-10310	857-10290	857-10296	857-10021	857-10287	857-10284
	Dummy	857-10283	857-10315	857-10309	857-10306	857-10312	857-10292	857-10301	857-10019	857-10289	857-10286
Modern	Active	857-10317	857-10350	857-10344	857-10341	857-10347	857-10326	857-10336	857-10332	857-10323	857-10320
	Inactive	857-10316	857-10349	857-10343	857-10340	857-10346	857-10325	857-10334	857-10331	857-10322	857-10319
	Dummy	857-10318	857-10351	857-10345	857-10342	857-10348	857-10327	857-10339	857-10333	857-10324	857-10321

## TRUTH'S SENTRY™ MULTI-POINT HANDLE SETS ACCESSORIES

### Conversion Kit

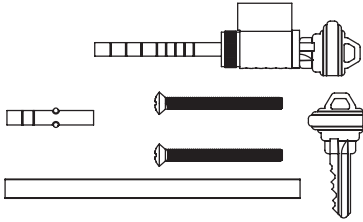

Part Number	Finish
857-10145	Antique Brass
857-10146	Beige
857-10147	White
857-10148	PVD Nickel
857-10150	Black
857-10151	Faux Bronze
857-10152	PVD Brass
857-10153	PVD Chrome
857-10154	PVD Bronze
857-10155	PVD Brushed Chrome

2-1/4" Door Conversion Kit

### Door Handle Extension Kit



#### For 1-3/4" Door Thickness

Part Number	Finish
857-10123	Antique Brass
857-10124	Beige
857-10125	White
857-10126	PVD Nickel
857-10128	Black
857-10129	Faux Bronze
857-10130	PVD Brass
857-10131	PVD Chrome
857-10132	PVD Bronze
857-10133	PVD Brushed Chrome

#### For 2-1/4" Door Thickness

Part Number	Finish
857-10134	Antique Brass
857-10135	Beige
857-10136	White
857-10137	PVD Nickel
857-10139	Black
857-10140	Faux Bronze
857-10141	PVD Brass
857-10142	PVD Chrome
857-10143	PVD Bronze
857-10144	PVD Brushed Chrome

## TRUTH'S SENTRY™ ADJUSTABLE HINGES



Engineered for maximum strength and security, Sentry Hinges exceed ANSI grade 3 requirements for doors weighing up to 220 lbs. Sentry Hinges exceed ANSI grade 1 impact specifications. Sentry Hinges are made of extruded brass and extruded aluminum that provides superior strength and corrosion resistance. Sentry Hinges provided with non-removable pins for maximum security.

- Robust, Reliable and Attractive
- Industry standard 4" x 4" with 5/8" radius corner.
- Both Guide and Set Hinges take a 5/32" hex wrench
- Guide Hinge has a 11/64" adjustment and Set Hinge has a 1/4" adjustment
- Extruded brass hinges are provided in decorative finishes including PVD
- Extruded aluminum hinges are available in powder coated painted finishes
- Composite bushings provide noise-free operation

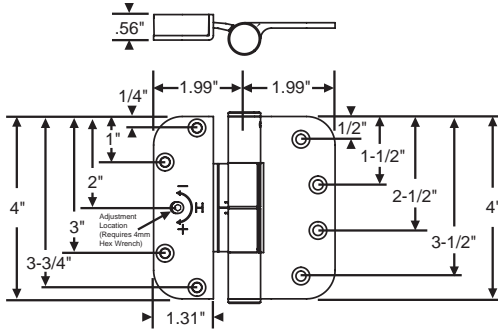

LEFT HAND SHOWN

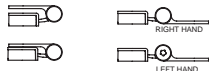

Extruded Brass Guide Hinges - Plated

Hand	Antique Brass	PVD Brushed Chrome	PVD Chrome	PVD Brass	PVD Bronze	PVD Nickel
LH	857-10352	857-10390	857-10382	857-10378	857-10386	857-10364
RH	857-10353	857-10391	857-10384	857-10379	857-10387	857-10365

Extruded Aluminum Guide Hinges - Painted

Hand	White	Snow White	Beige	Faux Bronze	Black
LH	857-10360	857-10368	857-10356	857-10002	857-10372
RH	857-10361	857-10369	857-10357	857-10001	857-10373

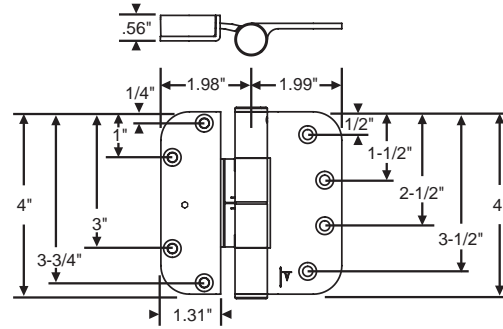

LEFT HAND SHOWN

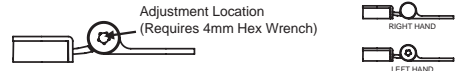

Extruded Brass Set Hinges - Plated

Hand	Antique Brass	PVD Brushed Chrome	PVD Chrome	PVD Brass	PVD Bronze	PVD Nickel
LH	857-10394	857-10432	857-10424	857-10420	857-10428	857-10406
RH	857-10395	857-10433	857-10425	857-10421	857-10429	857-10407

Extruded Aluminum Set Hinges - Painted

Hand	White	Snow White	Beige	Faux Bronze	Black
LH	857-10402	857-10410	857-10398	857-10004	857-10414
RH	857-10403	857-10411	857-10399	857-10003	857-10415

## TRUTH'S SENTRY™ MULTI-POINT SWING DOOR SYSTEM QUESTIONNAIRE

Acct. #: \_\_\_\_\_ Date: \_\_\_\_\_  
 Customer Name: \_\_\_\_\_ Phone: \_\_\_\_\_  
 Address: \_\_\_\_\_ Fax: \_\_\_\_\_  
 Contact: \_\_\_\_\_ E-mail: \_\_\_\_\_

1. Choose Between 5 Active and 2 Inactive Multi-Point Systems

**3 Point Tongue**

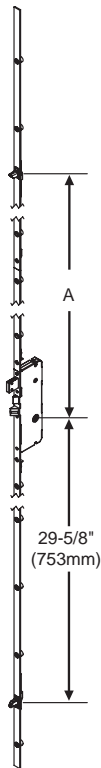

Door	A
71"-81"	29-7/32" (742mm)
81"-89"	39-7/32" (996mm)
89"-97"	47-7/32" (1199mm)
97"-105"	53-7/32" (1352mm)
105"-113"	63-7/32" (1606mm)
113"-121"	71-7/32" (1809mm)

A= Top Tongue Position

**3 Point Hook**

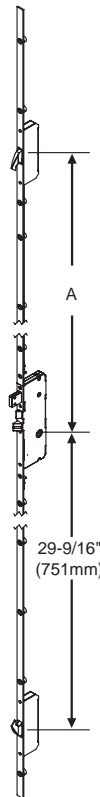

Door	A
71"-81"	29-5/32" (740mm)
81"-89"	39-5/32" (994mm)
89"-97"	47-5/32" (1198mm)
97"-105"	53-5/32" (1350mm)
105"-113"	63-5/32" (1604mm)
113"-121"	71" (1807mm)

A= Upper Hook Position

**3 Point Shootbolt**



**5 Point Tongue/ Shootbolt**

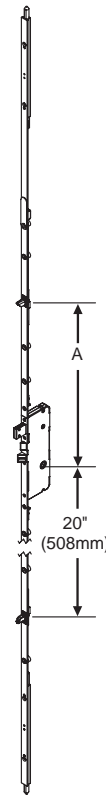

Door	A
71"-81"	16-1/2" (343mm)
81"-97"	24-1/2" (546mm)
97"-113"	40-1/4" (1022mm)
113"-121"	48-1/4" (1225mm)

A= Top Tongue Position

**5 Point Hook/ Shootbolt**

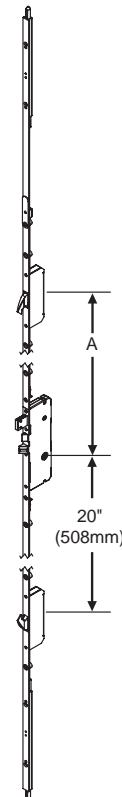

Door	A
71"-81"	16-5/32" (410mm)
81"-97"	24-5/32" (614mm)
97"-113"	40-5/32" (1020mm)
113"-121"	48-5/32" (1223mm)

A= Top Hook Position

**2 Point Shootbolt**



**All of the above locking systems have the following features:**

- 36" Handle Height
- 92mm Spacing
- Latch bolts are reversible by pulling out and rotating 180°
- 1" Deadbolt & Shootbolt throw
- Thumbturn above the lever - North American design
- Independent dead bolt - secure door without engaging other locking points.
- Anti slam device preventing damage to door
- Available with 16mm or 20mm face plate
- Multi-Point systems are made of 300 series stainless steel

**2 Point Lever Activated Flush bolt**

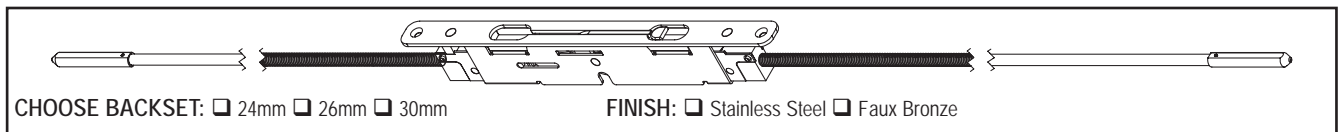

- FACE PLATE WIDTH: The metal plate that runs the length of the door:  
 5/8" (16mm)  25/32" (20mm)
- BACKSET:  1-3/8" (35mm)  1-3/4" (45mm)  2-3/8" (60mm)
- DOOR PANEL HEIGHT: (Do not include sweeps): \_\_\_\_\_
- DOOR THICKNESS: \_\_\_\_\_

**When Ordering Hinges:**

- Handing of Door:  Left Hand  Right Hand
- Number of Hinges on Door: \_\_\_\_\_
- Weight of Door: \_\_\_\_\_

## TRUTH'S SENTRY™ MULTI-POINT STRIKES

### Latch/Deadbolt Strikes

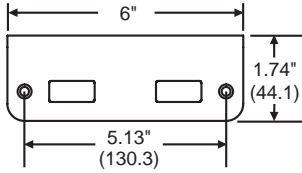

Part #	Material	Finish
857-10116	Stainless Steel	Brushed
857-10173	Stainless Steel	Black
857-10175	Stainless Steel	Faux Bronze
857-10171	Stainless Steel	Beige
857-10172	Stainless Steel	White
857-10117	Solid Brass	Antique Brass
857-10177	Solid Brass	PVD Brass
857-10179	Solid Brass	PVD Bronze

For 1-3/4" Doors

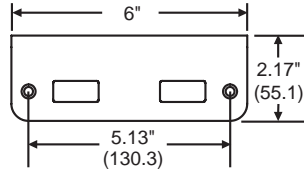

Part #	Material	Finish
857-10107	Stainless Steel	Brushed
857-10156	Solid Brass	Antique Brass
857-10158	Solid Brass	PVD Brass

For 2-1/4" Doors

### Tongue Strikes

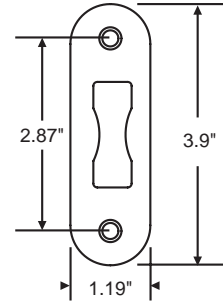

Part #	Material	Finish
857-10111	Stainless Steel	Brushed
857-10165	Stainless Steel	Black
857-10167	Stainless Steel	Faux Bronze
857-10113	Stainless Steel	Beige
857-10114	Stainless Steel	White
857-10112	Solid Brass	Antique Brass
857-10169	Solid Brass	PVD Brass
857-10170	Solid Brass	PVD Bronze

### Hookbolt Strikes

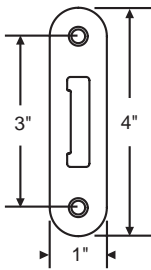

Part #	Material	Finish
857-10118	Stainless Steel	Brushed
857-10119	Solid Brass	Antique Brass
857-10180	Solid Brass	PVD Brass
857-10181	Solid Brass	PVD Bronze

### Shootbolt Cover Plate

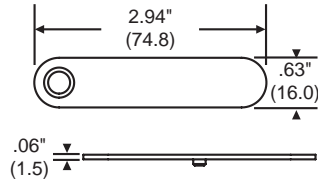

Part #	Material	Finish
857-10005	Stainless Steel	Brushed

### Shootbolt Strikes

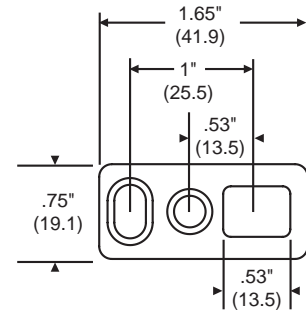

Part #	Material	Finish
857-10110	Stainless Steel	Brushed
857-10163	Stainless Steel	Faux Bronze

### Shootbolt Strikes

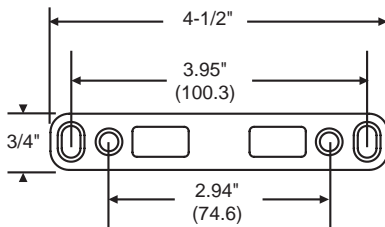

Part #	Material	Finish
857-10000	Stainless Steel	Brushed
857-10161	Stainless Steel	Faux Bronze

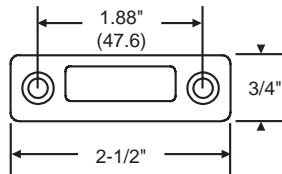

Part #	Material	Finish
857-10109	Stainless Steel	Brushed
857-10159	Stainless Steel	Faux Bronze

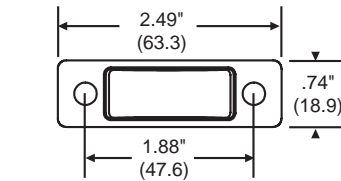

Part #	Material	Finish
857-10115	Stainless Steel	Brushed

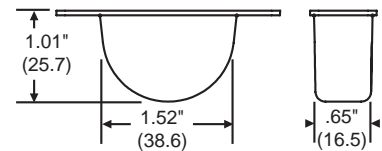

## FRENCHWOOD HINGED DOORS (1988 TO PRESENT) - 2 PANEL, 3 PANEL AND STATIONARY

### Multi-Point Locking Mechanisms / Current

Note: Lock mechanisms for custom sized doors are made to order. Product ID label is located on top edge of operating panel.

To order, state: Description of part (Lock Mechanism, Active or Passive), Quantity and Product ID

#### Hook Bolt Lock Mechanism - 3-Point / Stainless Steel / Active (March 2003 to Present)

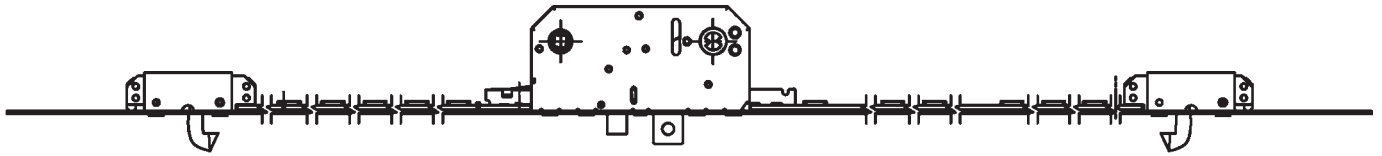

Note: Stainless steel active lock mechanism replaces all previous vintage active lock mechanisms.

Part Number	Length	Door Size
56-351	76-13/32"	6' 8"
56-352	79-9/32"	6' 11"
56-363	86-13/32"	7' 6"
56-353	92-13/32"	8'

#### Flush Bolt Locking Mechanism - 2-Point / Stainless Steel / Passive (March 2003 to Present)

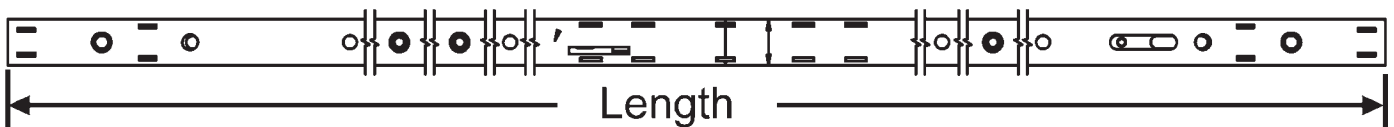
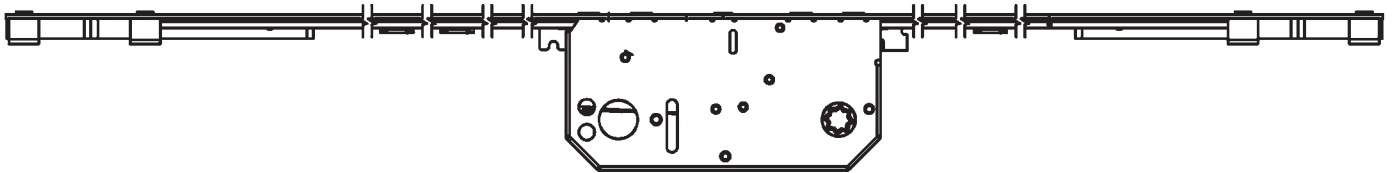

Note: Replace a stainless steel passive lock with a stainless steel passive replacement lock. This replaces all previous vintage stainless steel passive locks. Zinc dichromate lock no longer available; use stainless steel lock kit as replacement (see below).

Part Number	Length	Door Size
56-354	76-7/16"	6' 8"
56-355	79-11/32"	6' 11"
56-364	86-7/16"	7' 6"
56-356	92-7/16"	8'

#### Replacement Stainless Steel Lock Kit for Passive/Zinc Dichromate Lock Mechanism (1993 to March 2003)

Note: The zinc dichromate (gold finish appearance) passive lock is no longer available. Replace with stainless steel lock kit.

Kit Includes: (1) Instruction Guide, (1) Stainless Steel Passive Lock Mechanism, (2) Hook Bolt Receivers, (2) Flush Bolt Receivers, (1) Latch Receiver Blocker

Part Number	Length	Door Size
56-360	76-7/16"	6' 8"
56-361	79-11/32"	6' 11"
56-362	86-7/16"	8'

**HOOK BOLT PARTS**

**Hook Bolt Receiver with Screws**

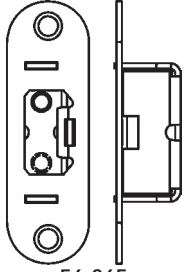

**56-365**

March 2003 to Present  
Single SA/AS. 3-Panel

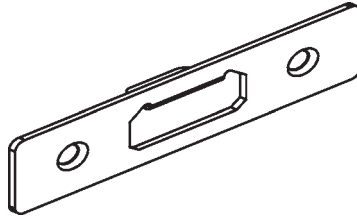

**56-366**

March 2003 to Present  
AP/PA

**Hook Bolt Blocker**

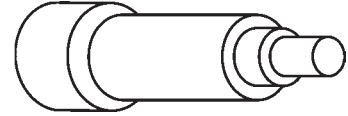

**56-367**

March 2003 to Present  
Use with Stainless Steel Lock Mechanism

**FLUSH BOLT PARTS**

**Flush Bolt Receiver**

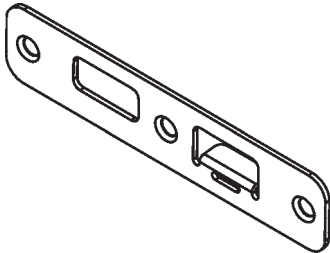

**56-368**

March 2003 to Present. Use with Stainless Steel Lock Mechanism. Head PA/Sill AP

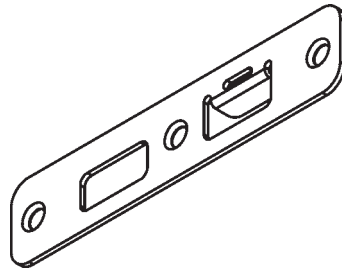

**56-369**

March 2003 to Present. Use with Stainless Steel Lock Mechanism. Head AP/Sill PA

**Flush Bolt Screw**



**56-370**

March 2003 to Present. Use with Stainless Steel Lock Mechanism. #10-12 x 3" Type 17

**LATCH BOLT PARTS**

**Latch Bolt Receiver**

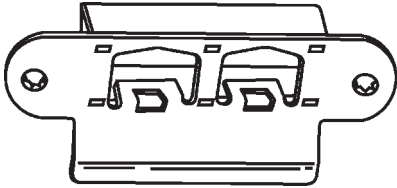

**56-371**

March 1990 to Present. Replaces All Previous Vintage Latch Receivers. Used on Patio Doors without a Passive Panel: AL, AR, SAR, SAL, SASL, SASR

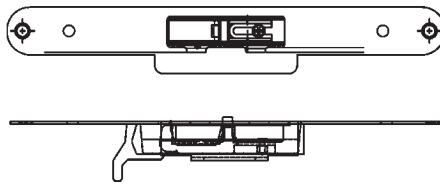

**56-372**

March 2003 to Present. Replaces All Previous Vintage AP/PA Latch Receivers. Use 2003 to Present on Patio Doors with a Passive Panel: PALR, APLR.

**Latch Bolt Blocker**

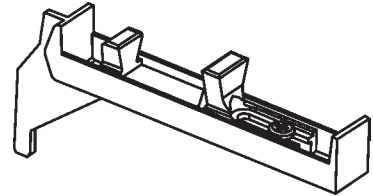

**56-373**

March 2003 to Present. Replaces All Previous Vintage AP/PA Latch Receivers. Use 2003 to Present on Patio Doors with Stainless Steel Lock Mechanism. Used on AP/PA Latch Bolt Receiver.

**LATCH BOLT PARTS**

**U Clip**

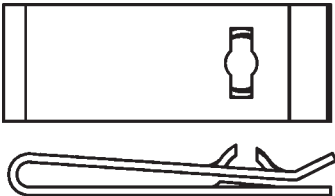

**56-374**

March 2003 to Present. Use with Stainless Steel Lock Mechanism. Used on AP/PA Latch Bolt Receiver.

**HARDWARE**

**Lock Limiting Plate with Tab**

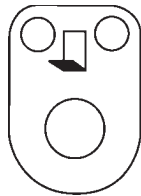

**56-358**

**Lock Actuator**

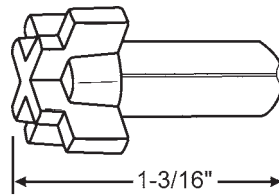

**56-359**

**Lock Mechanism Screw**



**56-375**

8-18 x 2" Type AB. Stainless Steel



## COLOR SUFFIX GUIDE

Oil Rubbed Bronze	ORBZ	Antique Brass	AB
Polished Chrome	PC	Polished Brass	PB
Brushed Chrome	BC	PVD Brass	BRS
Pewter	P	PVD Satin Nickel	SNK
Dark Bronze	DBZ	Distressed Satin Nickel	DSNK
Black	B	Distressed ORB	DORBZ
White	W	Antique Nickel	AN

## FUNCTION GUIDE

**Keyed:** Door sets have a cylinder on the outside backplate and a thumbturn on the interior backplate.  
**Non-Keyed:** Door sets have only the thumbturn on the interior plate.  
**Passive:** Door sets do not operate.

**ORDERING INSTRUCTIONS:** Select the proper part number from the charts below. Use the chart to the left to select your desired finish. Add the suffix at the end of the part number.

**EXAMPLE:** Part number 55-185 in a polished chrome finish, use part number 55-185PC

### EXPRESSIONS SERIES

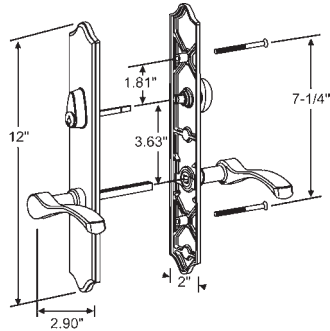

Expressions series trim sets are available in Oil Rubbed Bronze, Polished Chrome, Black, Antique Brass, PVD Brass, PVD Satin Nickel

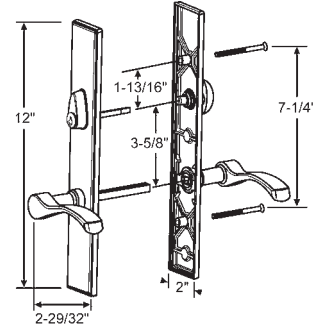

Part #	Function	Trim Set Series	Plate Size & Style	Door Size
55-185	Keyed	Expressions	12" Arch	1-3/4" - 2/14"
55-186	Passive	Expressions	12" Arch	1-3/4" - 2/14"

Part #	Function	Trim Set Series	Plate Size & Style	Door Size
55-147	Keyed	Expressions	12" Square	1-3/4" - 2/14"
55-142	Passive	Expressions	12" Square	1-3/4" - 2/14"

### TRUE ELEGANCE SERIES

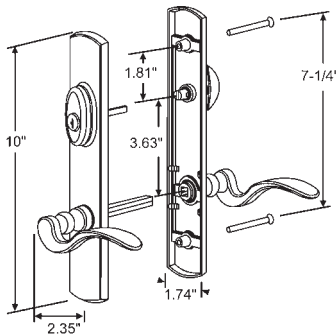

True Elegance series trim sets are available in Oil Rubbed Bronze, Polished Chrome, Brushed Chrome, Pewter, Dark Bronze, Black, White, Antique Brass, Polished Brass, PVD Brass, PVD Satin Nickel, Antique Nickel

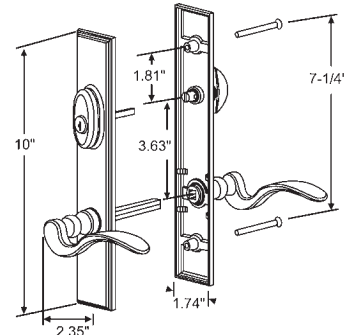

Part #	Function	Trim Set Series	Plate Size & Style	Door Size
55-203	Keyed	True Elegance	10" Half Round	1-3/4"
55-204	Passive	True Elegance	10" Half Round	1-3/4"

Part #	Function	Trim Set Series	Plate Size & Style	Door Size
55-149	Keyed	True Elegance	10" Square	1-3/4"
55-150	Passive	True Elegance	10" Square	1-3/4"

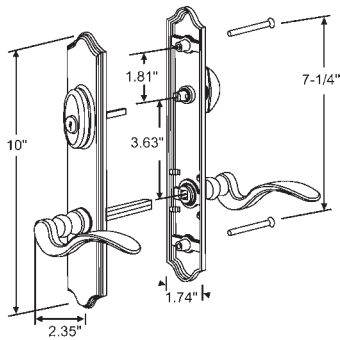

Part #	Function	Trim Set Series	Plate Size & Style	Door Size
55-211	Keyed	True Elegance	10" Arch	1-3/4"
55-212	Passive	True Elegance	10" Arch	1-3/4"
55-115	Keyed	True Elegance	10" Arch	2"
55-213	Non-Keyed	True Elegance	10" Arch	2"
55-116	Passive	True Elegance	10" Arch	2"

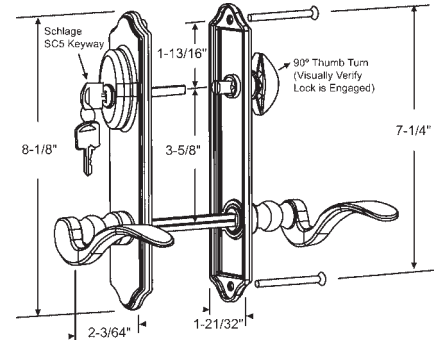

Part #	Function	Trim Set Series	Plate Size & Style	Door Size
55-101	Keyed	True Elegance	8" Arch	1-3/4"
55-160	Non-Keyed	True Elegance	8" Arch	1-3/4"
55-102	Passive	True Elegance	8" Arch	1-3/4"
55-159	Keyed	True Elegance	8" Arch	2"
55-197	Passive	True Elegance	8" Arch	2"

## SWING DOOR HANDLE SETS

### FORGINGS SERIES

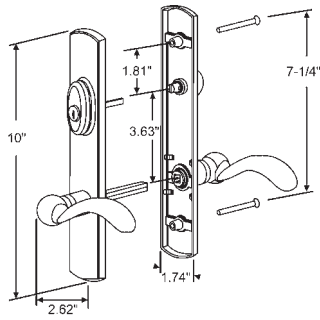

Forgings series trim sets are available in Oil Rubbed Bronze, Distressed Satin Nickel, Distressed Oil Rubbed Bronze, Antique Nickel

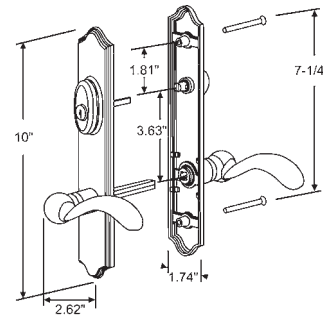

Part #	Function	Trim Set Series	Plate Size & Style	Door Size
55-201	Keyed	Forgings	10" Half Round	1-3/4"
55-202	Passive	Forgings	10" Half Round	1-3/4"

Part #	Function	Trim Set Series	Plate Size & Style	Door Size
55-209	Keyed	Forgings	10" Arch	1-3/4"
55-210	Passive	Forgings	10" Arch	1-3/4"

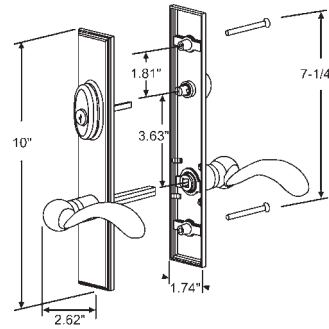
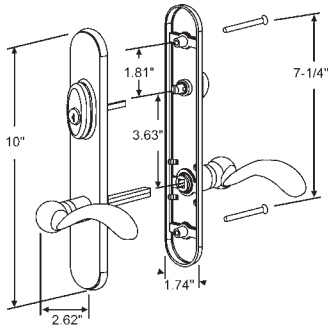

Part #	Function	Trim Set Series	Plate Size & Style	Door Size
55-207	Keyed	Forgings	10" Round	2"
55-208	Passive	Forgings	10" Round	2"
55-205	Keyed	Forgings	10" Round	1-3/4"
55-206	Non-Keyed	Forgings	10" Round	1-3/4"
55-187	Passive	Forgings	10" Round	1-3/4"

Part #	Function	Trim Set Series	Plate Size & Style	Door Size
55-214	Keyed	Forgings	10" Square	2"
55-215	Passive	Forgings	10" Square	2"
55-216	Keyed	Forgings	10" Square	1-3/4"
55-217	Passive	Forgings	10" Square	1-3/4"

### EVOLUTIONS SERIES

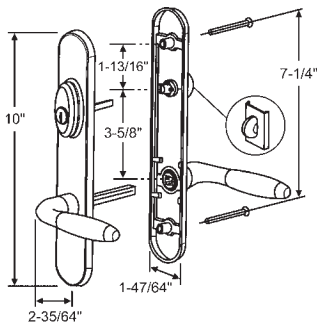

Evolutions series trim sets are available in Polished Chrome, Brushed Chrome, Pewter, Black, White

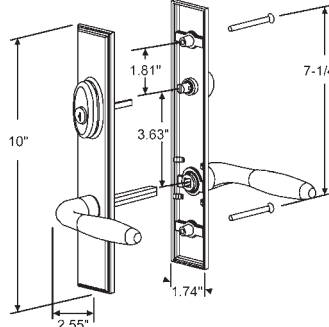

Part #	Function	Trim Set Series	Plate Size & Style	Door Size
55-189	Keyed	Evolutions	10" Round	1-3/4"
55-190	Passive	Evolutions	10" Round	1-3/4"

Part #	Function	Trim Set Series	Plate Size & Style	Door Size
55-154	Keyed	Evolutions	10" Square	1-3/4"
55-155	Passive	Evolutions	10" Square	1-3/4"

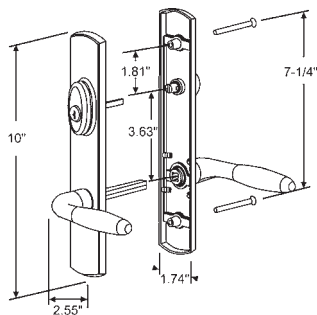

Part #	Function	Trim Set Series	Plate Size & Style	Door Size
55-198	Keyed	Evolutions	10" Half Round	2"
55-199	Passive	Evolutions	10" Half Round	2"
55-122	Keyed	Evolutions	10" Half Round	1-3/4"
55-200	Non-Keyed	Evolutions	10" Half Round	1-3/4"
55-123	Passive	Evolutions	10" Half Round	1-3/4"

## LOCK OPTIONS FOR FACE MOUNT AND CONCEALED MULTI-POINT LOCKS

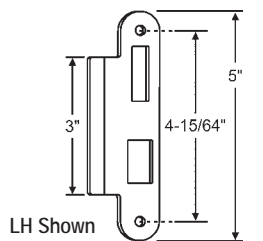

LH Shown

Part #	Finish	Hand
56-116	Stainless Steel	LH
56-117	Stainless Steel	RH
56-116PB	Polished Brass	LH
56-117PB	Polished Brass	RH
56-116ORB	Oil Rubbed Bronze	LH

Strike

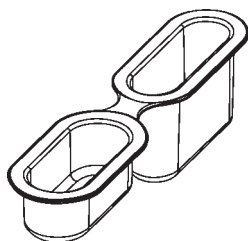

**56-138**  
Jamb Basket

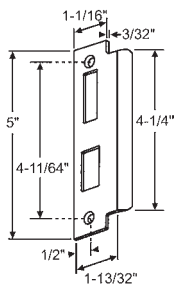

Part #	Hand
56-192RH	RH (shown)
56-192LH	LH

Strike

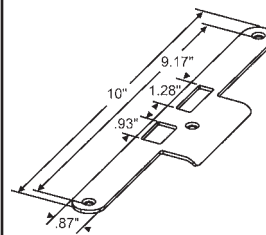

Part #	Hand
56-450SS-RH	RH (shown)
56-450SS-LH	LH

Strike

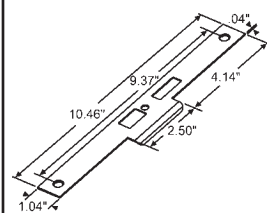

Part #	Hand
56-451SS-RH	RH (shown)
56-451SS-LH	LH

Strike

## CONCEALED MULTI-POINT SWING DOOR LOCK SYSTEM

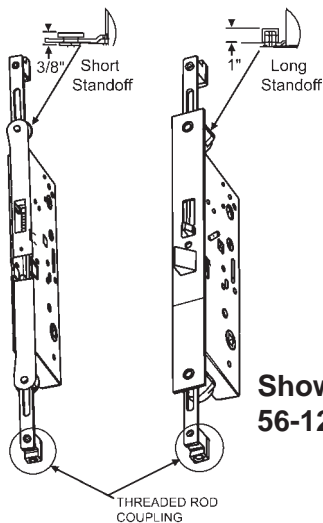

**Shown:**  
56-170

**Shown:**  
56-121

Part #	Version	Backset	Coupling Thread	Standoff	Faceplate Attached
56-121	Active	60mm	1/4-20	Long	Yes
56-151	Active	60mm	1/4-20	Short	No
56-175*	Active	60mm	5/16-18	Short	No
56-170	Passive	60mm	1/4-20	Short	No
56-178*	Passive	60mm	5/16-18	Short	No
56-122	Passive	60mm	1/4-20	Long	Yes

\* Used Exclusively by PGT

## SINGLE POINT MORTISE LOCK

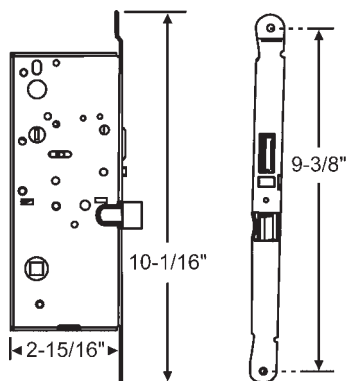

**56-109**

Mortise Lock for 59-110 Face Plate

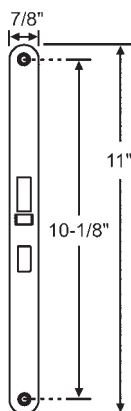

**56-110**

Face Plate

## SWING DOOR HANDLE

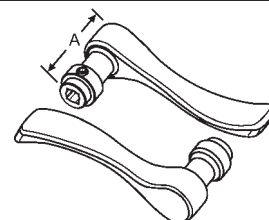

Part #	Description	"A" Dim
56-197S-ORBZ	Short ORB	1-63/64"
56-197S-CH	Short Chrome	1-63/64"
56-197S-B	Short Black	1-63/64"
56-197S-AB	Short Antique	1-63/64"
56-197S-BRS	Short PVD Brass	1-63/64"
56-197S-SNK	Short PVD Satin Nickel	1-63/64"
56-197T-ORBZ	Tall ORB	2-33/64"
56-197T-CH	Tall Chrome	2-33/64"
56-197T-B	Tall Black	2-33/64"
56-197T-AB	Tall Antique	2-33/64"
56-197T-BRS	Tall PVD Brass	2-33/64"
56-197T-SNK	Tall PVD Satin Nickel	2-33/64"

# SWING DOOR HARDWARE

## SWING DOOR HANDLE SETS

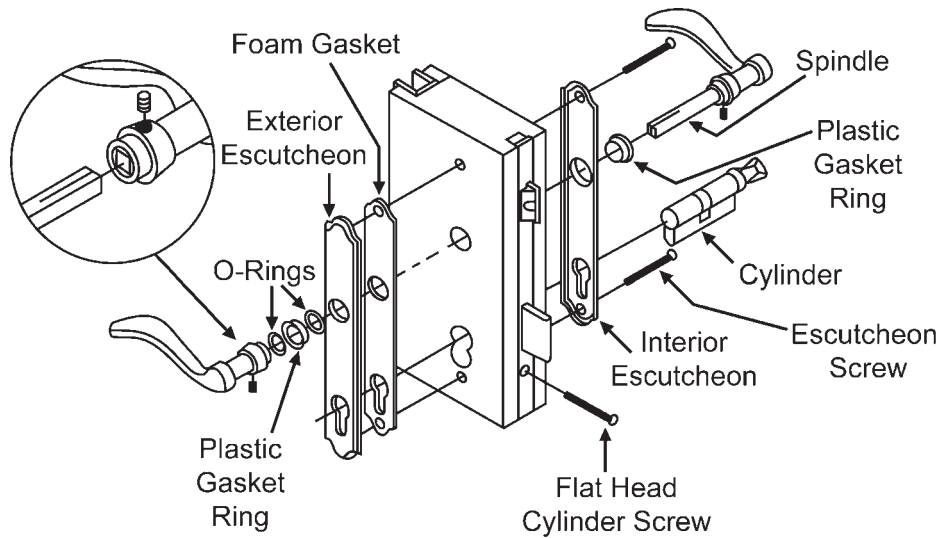

Active Lever Handle Set (Shown) -  
Thumb Turn w/Key

Part #	Finish
55-111BC	Brushed Chrome
55-111CP	Chrome Plated
55-111W	White
55-111AB	Antique Brass
55-111BRS	Brass

Dummy Lever Handle Set -  
No Thumb Turn, No Key

Part #	Finish
55-157AB	Antique Brass
55-157BC	Brushed Chrome
55-157CP	Chrome Plated
55-157W	White

## MILLTON 2-POINT LOCKSETS

1-1/2" Min / 1- 49/64" Max

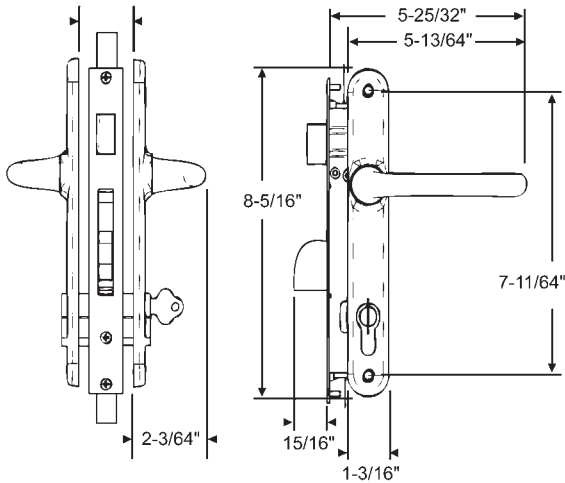

Through innovative design -combined with rigorous testing -comes the comprehensive range of Interlock Millton narrow stile, mortise lever locks. Attractive, durable, easy to install and operate, Millton fits a wide range of applications, and is the perfect complement to today's architecture.

### Features:

- Standard 2-Point
- Complete lockset without striker, and 30mm backset
- Stylish Verona handle
- C4 keyway (standard 5-pin)
- Concealed fixing on external escutcheon plate.
- Latch is deadlocked by key

Part #	Description
55-100W	White (Inside & Out)
55-100W/SCH	White (Inside) & Satin Chrome (Outside)

## EUROGROOVE STEPPED ROUTER BITS

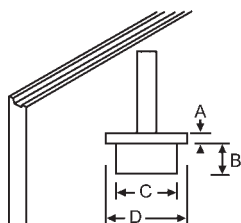

SBI #	MFG.	A	B	C	D
59-69S	Schlegel	1/8"	1/4"	3/4"	1"
59-69T	Truth	1/8"	13/32"	9/16"	51/64"
59-69GU	GU	3/32"	3/8"	31/64"	21/32"
59-69R	Roto- Frank	3/32"	23/64"	31/64"	5/8"
59-69	Hoppe (16mm)	1/8"	23/64"	1/2"	5/8"
59-69W	Winkhaus/Hoppe (20mm)	3/32"	23/64"	31/64"	25/32"
59-69W-1	Winkhaus	3/32"	23/64"	31/64"	41/64"

## STEEL PLAIN BEARING BUTT HINGES WITH NON-RIISING REMOVABLE PIN

### Steel Plain Bearing Butt Hinges with Removable Pin (Non-Rising).

These hinges are packed and **sold by the pairs**. All hinges supplied with flat head phillips screws.

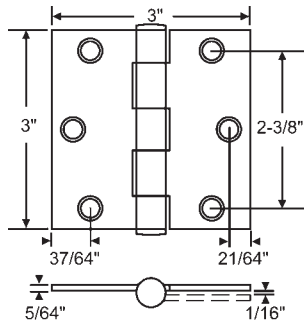

Part Number	Finish	Thickness
56-260SBRS	Satin Brass	2.0 mm

Square Corner. 3" x 3"

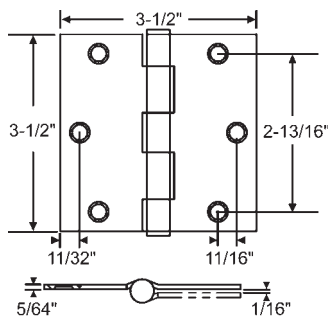

Part Number	Finish	Thickness
56-263SBRS	Satin Brass	2.2 mm
56-263SNK	Satin Nickel	2.2 mm

Square Corner. 3-1/2" x 3-1/2"

### Steel Plain Bearing Butt Hinges with Non-Removable Pin (Riveted)

This hinge is packed and **sold by the pairs**. All hinges are supplied with flat head phillips wood screws.

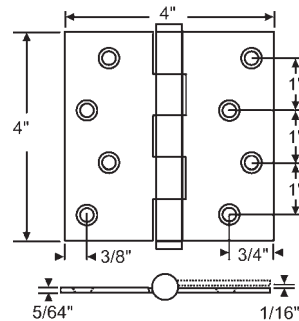

Part Number	Finish	Thickness
56-441	Zinc Plated US2	2.2 mm

Square Corner. 4" x 4"

### Steel Plain Bearing Butt Hinges with Non-Removable Pin

These hinges are packed and **sold in sets of three**. All hinges are supplied with flat head phillips wood screws.

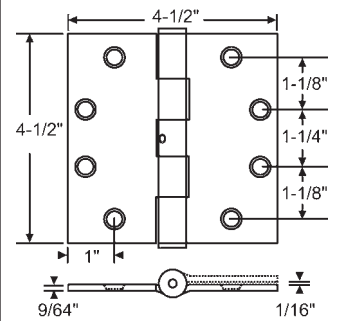

Part Number	Finish	Thickness
56-402SCH	Satin Chrome	3.4 mm
56-402USP	Gray Prime Coat	3.4 mm

Square Corner. 4-1/2" x 4-1/2"

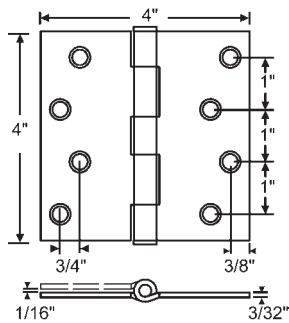

Part Number	Finish	Thickness
56-264SBRS	Satin Brass	2.5 mm
56-264SNK	Satin Nickel	2.5 mm

Square Corner. 4" x 4"

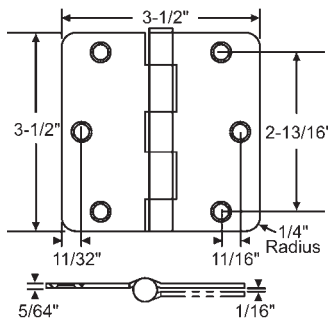

Part Number	Finish	Thickness
56-261SBRS	Satin Brass	2.2 mm

1/4" Radius. 3-1/2" x 3-1/2"

### Steel Spring Hinges Single Action, UL Listed

These spring hinges are packed and **sold individually**. All spring hinges supplied with flat head phillips wood and machine screws, hex wrench and instructions

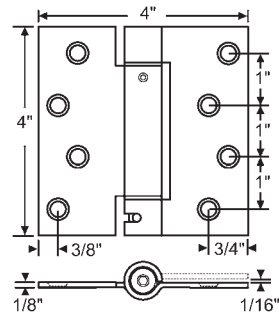

Part Number	Finish	Thickness
56-403SNK	Satin Nickel	3.3 mm

Square Corner. 4" x 4"

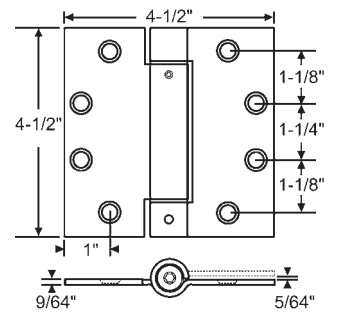

Part Number	Finish	Thickness
56-316SBRS	Satin Brass	3.4 mm
56-316SCH	Satin Chrome	3.4 mm
56-316USP	Gray Prime Coat	3.4 mm

Square Corner. 4-1/2" x 4-1/2"

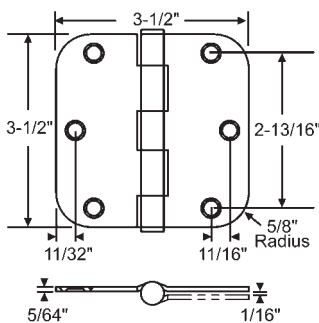

Part Number	Finish	Thickness
56-262SBRS	Satin Brass	2.2 mm
56-262SNK	Satin Nickel	2.2 mm
56-262SCH	Satin Chrome	2.2 mm

5/8" Radius. 3-1/2" x 3-1/2"

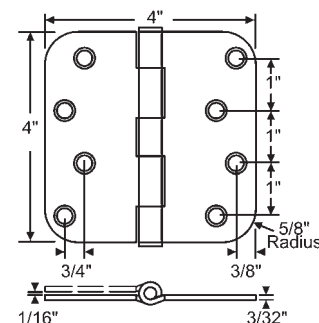

Part Number	Finish	Thickness
56-179SBRS	Satin Brass	2.5 mm
56-179SNK	Satin Nickel	2.5 mm
56-179SCH	Satin Chrome	2.5 mm

5/8" Radius. 4" x 4"

### Steel 2 Ball Bearing Butt Hinges

These ball bearing hinges are packed and **sold in sets of three**. All hinges are supplied with flat head phillips wood and machine screws.

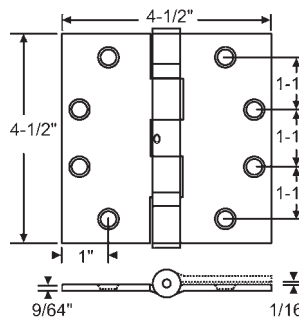

Part Number	Finish	Thickness
56-321SCH	Satin Chrome	3.4 mm

Square Corner. 4-1/2" x 4-1/2"  
Non-Removable Pin

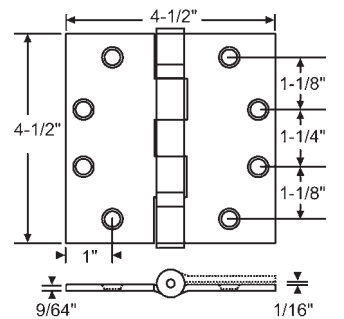

Part Number	Finish	Thickness
56-413SCH	Satin Chrome	3.4 mm

Square Corner. 4-1/2" x 4-1/2"  
Removable Pin (Non-Rising)

# SWING DOOR HARDWARE

## HINGES

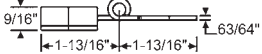
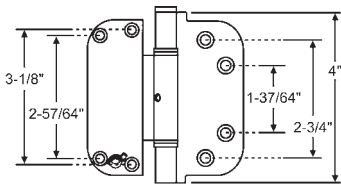

Adjustable Set Hinge  
With Non-Removable Pin

Part #	Finish
56-224AB	Antique Brass
56-224BC	Brushed Chrome
56-224ORBZ	Oil Rubbed Bronze
56-224PB	Polished Brass
56-224PC	Polished Chrome
56-224TN	Tan
56-224W	White

Steel

**WINDSOR/ SUPERIOR**

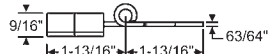
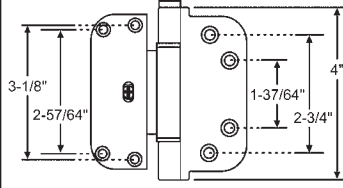

Adjustable Guide Hinge

Part #	Finish
56-223AB	Antique Brass
56-223BC	Brushed Chrome
56-223ORBZ	Oil Rubbed Bronze
56-223PB	Polished Brass
56-223PC	Polished Chrome
56-223TN	Tan
56-223W	White

Steel

**WINDSOR/ SUPERIOR**

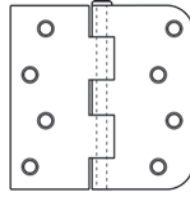

Residential Door Hinge

Part #	Description
56-272SNK	With Removable Pin
56-273SNK	With Non-Removable Pin

- Steel Base Metal
- Square corner x 5/8" radius
- Plain bearing, five knuckle
- 4.0" material gauge= .099" (2.5mm)
- 4" X 4" Square Corner x 5/8" Radius  
Satin Nickel

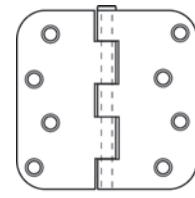

Residential Door Hinge

Part #	Description
56-270SSS	With Removable Pin
56-271SSS	With Non-Removable Pin

- Stainless Steel Base Metal
- 5/8" Radius corner on all corners
- Plain bearing, five knuckle
- 4.0" material gauge= .099" (2.5mm)
- 4" X 4" Square Corner x 5/8" Radius  
Brushed Stainless Steel

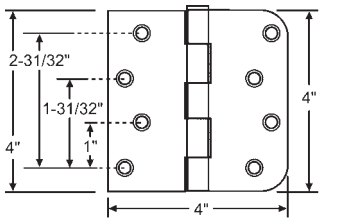

4" Square & Radius Corner Hinges

Part #	Hand
56-330RPB	RH Shown
56-330LPB	LH Opposite

Polished Brass Finish  
Sold in Pairs

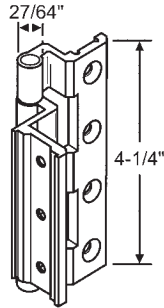

**56-325**

Converted Chromate  
Five Knuckle Butt Hinge  
Ready For Paint

## INTERLOCK

### ASSA ABLOY

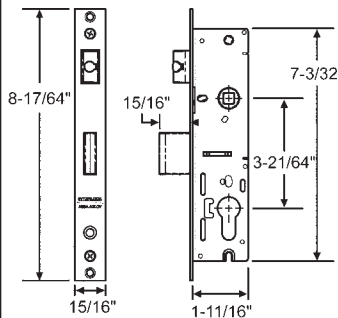

**56-169**

30mm Lock Body 2pt. Stainless Steel

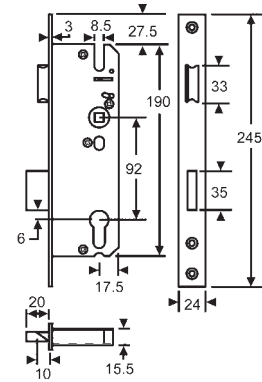

**56-329SS**

Stainless Steel  
**KVF**

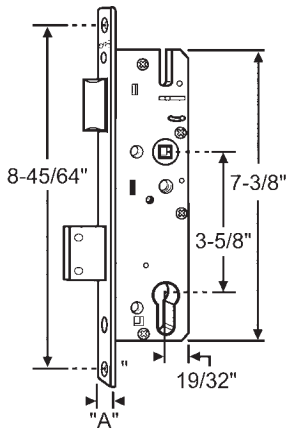

Part #	"A" Backset
56-180	30mm
56-276	35mm
56-277	40mm
56-278	45mm

Non-handed due to reversible latch, ball lock with lubricant, bright nickel-plated and deadbolt, deadbolt secured against sawing through inserted steel pins, deadbolt throw 25 mm, zinc-plated casing.  
Stainless Steel Face Plate  
**KVF/ INTERLOCK**

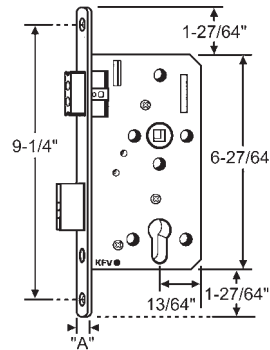

Part #	"A"	Faceplate
56-254	25/32"	20mm
56-255	45/64"	18mm

Non- Handed Magnetic Mortise Lock  
**KVF**

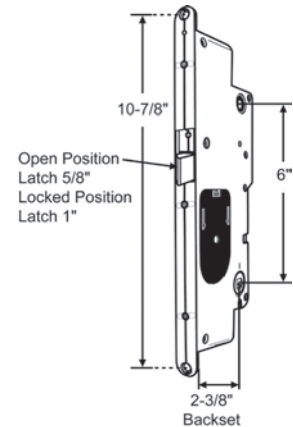

**56-101**

Reversible

**PEACHTREE IPD/CITADEL**  
For Installation Instructions contact  
account manager.

## MORTISE LOCKS

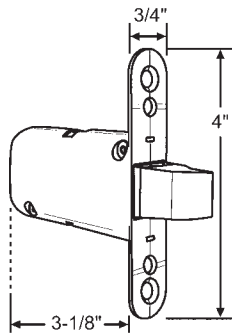

Part #	Finish
56-102LH	Shown

Inactive Door  
**PEACHTREE**

## MISCELLANEOUS SWING DOOR LOCKSETS

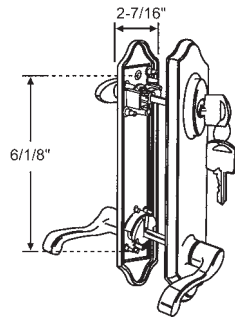

- Fits 2-1/8" Cross Bore on 6-3/32" Centers.
- Fits All Peachtree Prado Patio Doors
- Fits Right or Left Hand Doors

Part #	Finish
55-146PB	Polished Brass

This lockset also can be used on older Prado doors with a 1-3/4" cross bore.  
**PEACHTREE/PRADO**

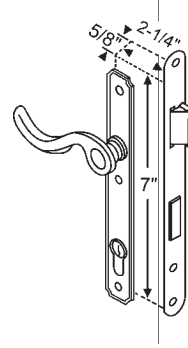

Part #	Finish
55-126PB	Polished Brass
55-126PC	Polished Chrome
55-126SNK	Satin Nickel

An Exact Replacement For Atrium Door

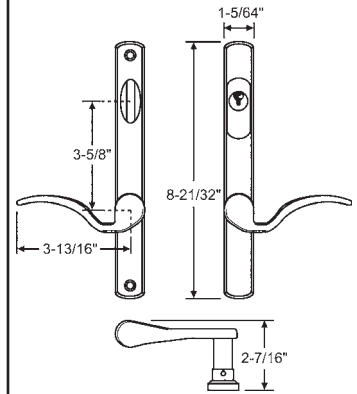

**55-196AB**

Privacy Handle Set  
Antique Brass Finish  
Solid Brass Handle

## MISCELLANEOUS SWING DOOR HARDWARE

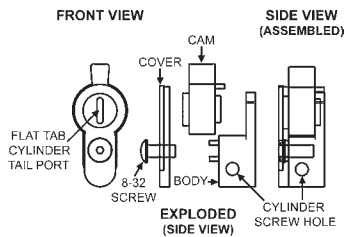

**56-344**

Euro to American Profile Cylinder.  
Adapter Converts Euro Profile Cylinder Mechanisms to Except American Type Key Cylinders Having Flat Tab Cylinder Tails

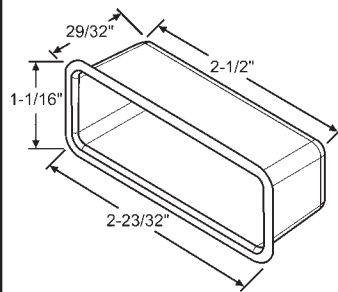

**56-269**

Tru-Lock Dust Cap. Black PVC  
**AMESBURY**

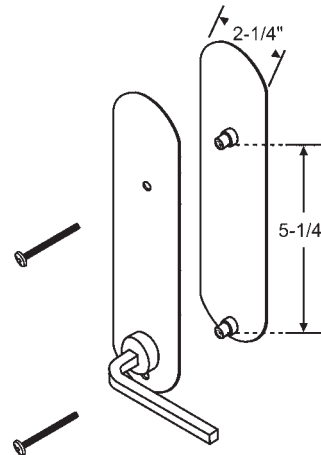

This Construction Hardware is designed specifically to be used with the W & F Trilennium™ multi-point locking system. It saves the finish handle sets from damage and acts as a paint shield during the construction phase. Although not intended as a security device, the Construction Hardware prevents direct access to the locking mechanism from the exterior. It's sturdy all metal construction also makes it reusable for multiple phases or different job sites.

**55-117**

Construction Handle  
**W&F TRILENNIUM**

## STORM DOOR HANDLE SET

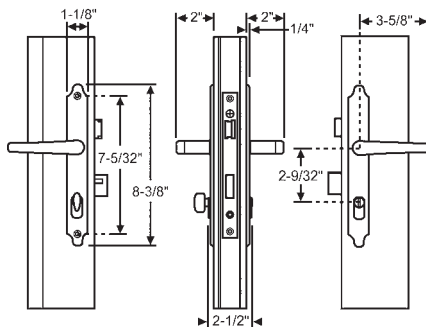

Part #	Finish
19-466	Polished Brass
19-466B	Black
19-466SNK	Satin Nickel
19-466W	White

Complete Handle Set  
w/ Mortise Lock, Single Deadbolt & Strike

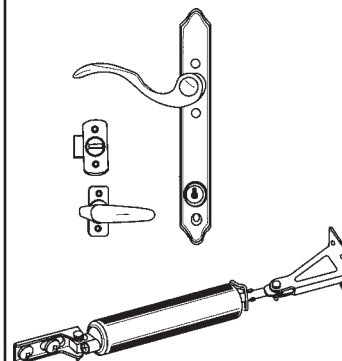

**19-441**

Storm Door Handle Set w/ Closer  
Brass Outside, White Inside

## ZINC BUSHING REPLACEMENT KIT

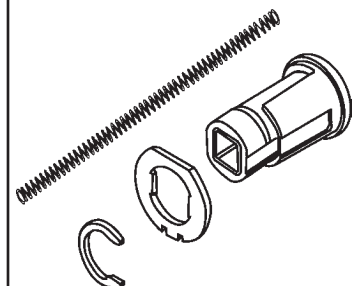

**56-115B**

Black. For Eclipse, French, Single Island and Double Island Handle. See Page 358.

# SWING DOOR HARDWARE

## HANDLE SETS

Eclipse Series Handle Set- Keyed

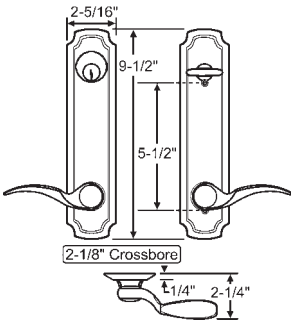

Part #	Finish
55-220BRS	Brass Plated
55-220SNK	Satin Nickel (Shown)

Includes: Key Cylinder (Weiser keyway), Latch & Deadbolt set with 2-3/8" Backset, Radius Strike Plates, Spindle 9/32" SQ X 1-1/2", Mounting Screws 10-32 TH X 2-1/8"

Eclipse Series Handle Set- Keyless

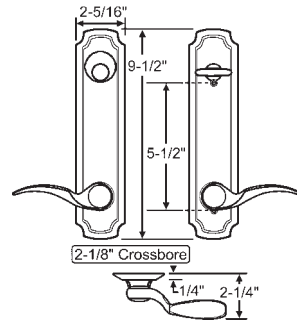

Part #	Finish
55-236ANK-X	Antique Nickel (Shown)
55-236VBZ-X	Victorian Bronze

Note: Does Not Include Anything Else (NO HARDWARE, SCREWS, NOTHING)

French Series Handle Set- Keyed

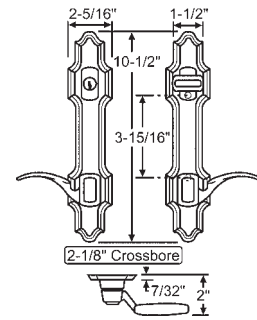

Part #	Finish
55-226AB	Antique Brass

Includes: Key Cylinder (Weiser keyway), Latch & Deadbolt set with 2-3/8" Backset, Radius Strike Plates, Spindle 9/32" SQ X 2-9/16", Mounting Screws 10-32 TH X 2-7/16"

Single Island Escutcheons/ Versailles Handles (Patio Door Trimset w/ Key)

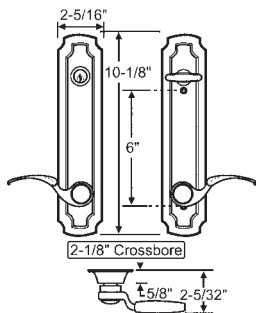

Part #	Finish
55-234PB	Polished Brass

Includes: Key Cylinder (Weiser keyway), Latch & Deadbolt set with 2" Backset, Radius Strike Plates and 1/4" x 1-1/2" Spindle

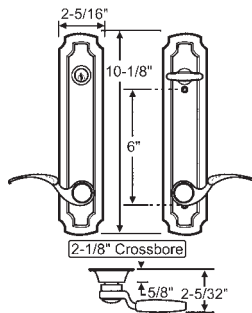

Part #	Finish
55-233AB	Antique Brass

Includes: Key Cylinder (Weiser keyway), Latch & Deadbolt set with 2-3/8" Backset and Radius Strike Plates

Double Island Escutcheons/ Versailles Handles Patio Door Trimset

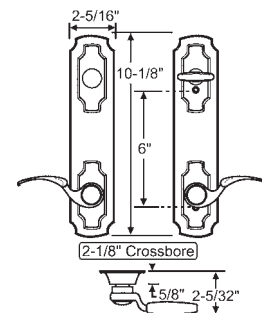

Part #	Description
13-283BBK-1	With Key
13-283BB-1	No Key

Bright Brass



## BI-FOLD CLOSET DOOR PIN ASSEMBLIES

In Order by Pin Diameter & Height

### 1/4" DIAMETER

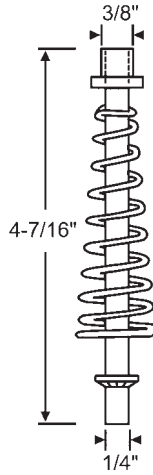
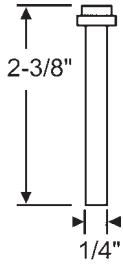

Assembly # 1-250	
Pin w/Cap	1-243
Cap	4-119
Spring	5-51
Push Nut	6-122

**FENESTRA**

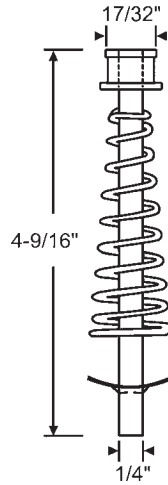

Assembly # 1-161	
Pin w/Cap	1-160
Cap	4-105
Spring	5-51
Tinnerman Clip	6-143

**NATIONAL**

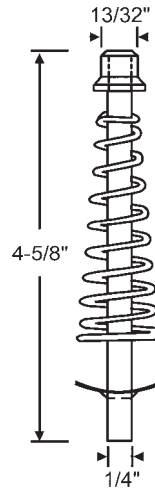

Assembly # 1-159	
Pin w/Cap	1-158
Cap	4-115
Spring	5-51
Tinnerman Clip	6-143

**PEACHTREE**

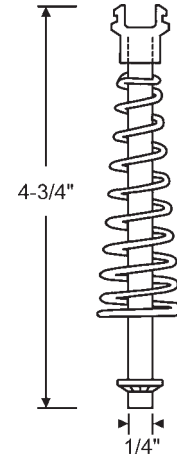

Assembly # 1-131	
Pin w/Cap	1-130
Cap	4-108
Spring	5-51
Push Nut	6-122

**NATIONAL**

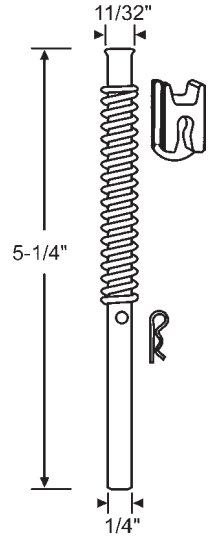

Assembly # 1-145	
Guide Cap	4-111
Spring	5-50
Hairpin Clip	6-136

**LEIGH/MONARCH**

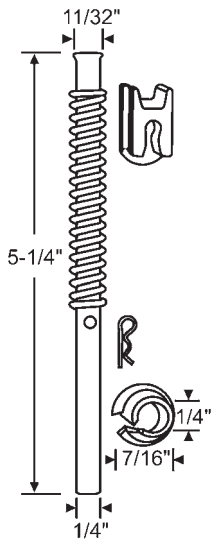

Assembly # 1-145A	
Guide Cap	4-111
Spring	5-50
Hairpin Clip	6-136
Grommet (2x)	8-259

**LEIGH/MONARCH**

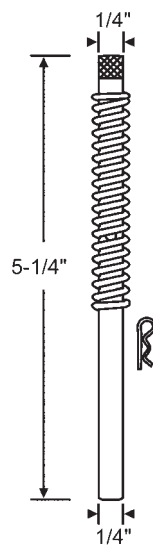

Assembly # 1-153	
Spring	5-50
Hairpin Clip	6-136

**LEIGH/MONARCH**

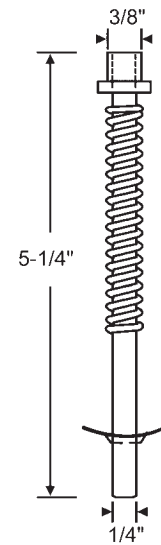

Assembly # 1-236	
Pin w/Cap	1-238
Cap	4-119
Spring	5-50
Tinnerman Clip	6-143

**FENESTRA**

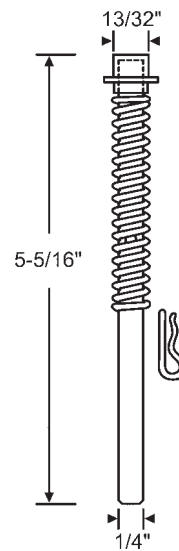

Assembly # 1-163	
Pin w/Cap	1-162
Cap	4-104
Spring	5-50
Hairpin Clip	6-136

**LEIGH/MONARCH**

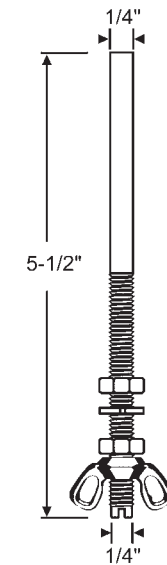

Assembly # 1-147	
Hex nut	6-129
Lock Washer	6-123
Wing Nut	6-132

**LEIGH/MONARCH**

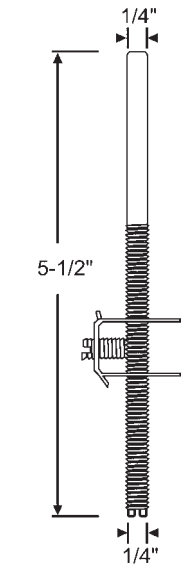

Assembly # 1-165	
Clevis w/Screw	6-134

**LEIGH/MONARCH**

# CLOSET DOOR HARDWARE

## BI-FOLD CLOSET DOOR PIN ASSEMBLIES

### 1/4" DIAMETER

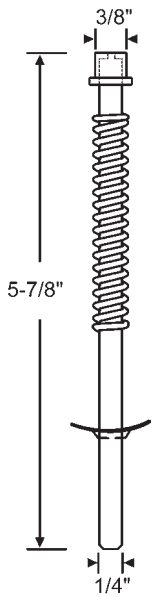

Assembly # 1-170	
Pin w/Cap	1-169
Cap	4-114
Spring	5-50
Tinnerman Clip	6-143

**BENCHMARK**

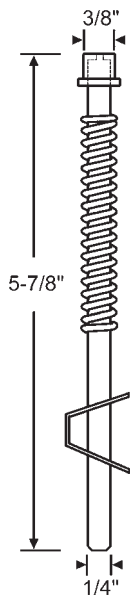

Assembly # 1-237	
Pin w/Cap	1-169
Cap	4-114
Spring	5-50
Compression Retainer	6-101

**BENCHMARK**

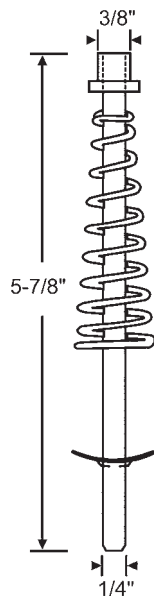

Assembly # 1-259	
Pin w/Cap	1-156K
Cap	4-119
Spring	5-51
Tinnerman Clip	6-143

**FENESTRA**

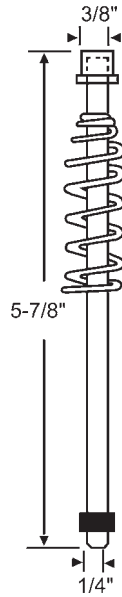

Assembly # 1-235	
Pin w/Cap	1-156
Cap	4-114
Spring	5-59

**FENESTRA**

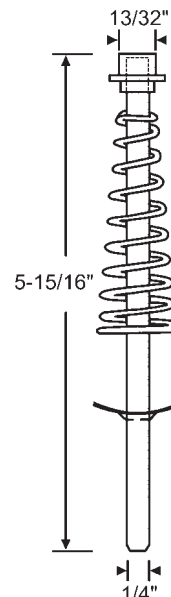

Assembly # 1-172	
Pin w/Cap	1-171
Cap	4-104
Spring	5-51
Tinnerman Clip	6-143

**LEIGH/MONARCH**

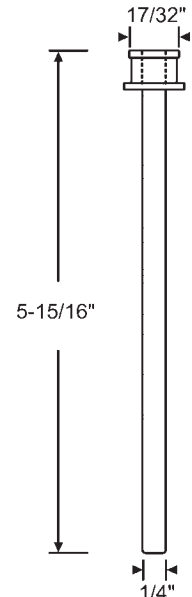

Assembly # 1-258	
Cap	4-105

**NATIONAL**

### 5/16" DIAMETER

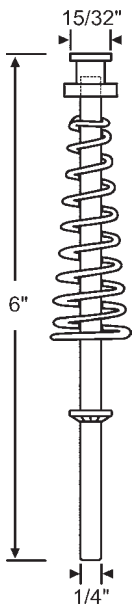

Assembly # 1-157	
Pin w/Cap	1-156
Cap	4-107
Spring	5-51
Push Nut	6-122

**NATIONAL**

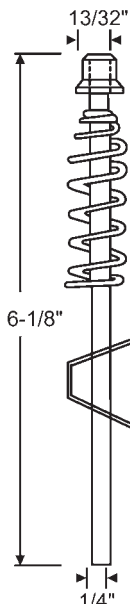

Assembly # 1-224	
Pin w/Cap	1-223
Cap	4-115
Spring	5-59
Compression Retainer	6-143

**PEACHTREE**

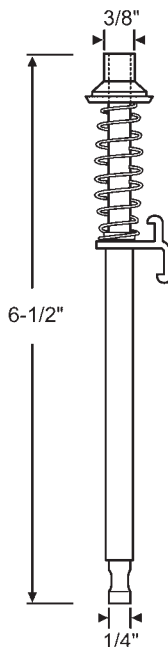

Assembly # 1-102	
Cap	4-120

With Plastic Sleeve

**SLIMFOLD**

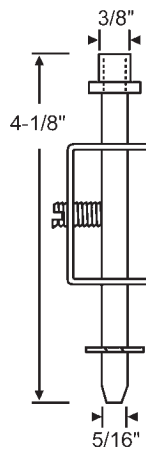

Assembly # 1-137	
Pin w/Cap	1-136
Cap	4-119
Clevis w/Screw	6-102
E-Ring	6-109

**FENESTRA**

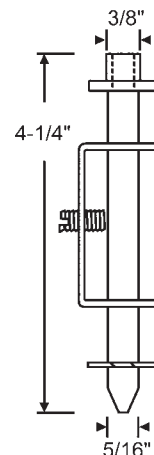

Assembly # 1-241	
Pin w/Cap	1-239
Cap	4-128
Clevis w/Screw	6-105
E-Ring	6-109

**FENESTRA**

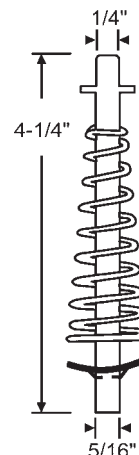

Assembly # 1-190	
Spring	5-51
Tinnerman Clip	6-141
E-Ring	6-109

Used with 1-186

**NATIONAL**

## BI-FOLD CLOSET DOOR PIN ASSEMBLIES

### 5/16" DIAMETER

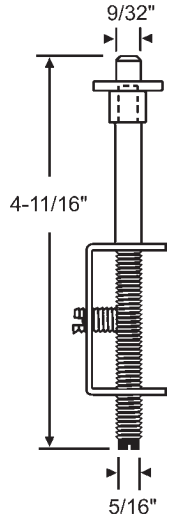
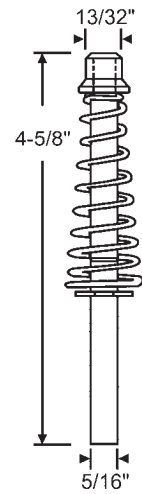
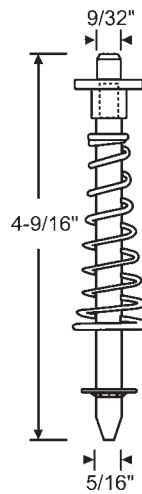
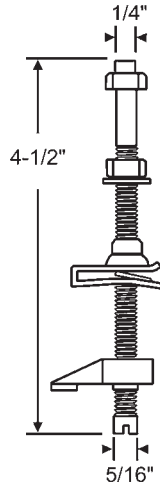
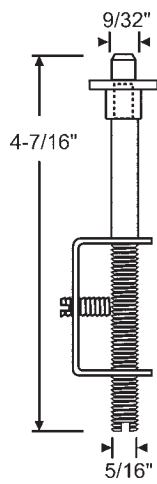
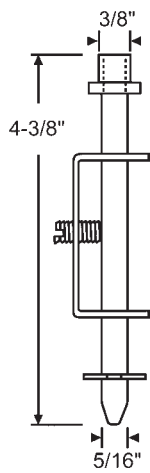

Assembly # 1-201	
Pin w/Cap	1-200
Cap	4-119
Clevis w/Screw	6-105
E-Ring	6-110

**FENESTRA**

Assembly # 1-180	
Pin w/Cap	1-179
Cap	4-118
Clevis w/Screw	6-103

**FENESTRA**

Assembly # 1-186	
Lock Washer	6-115
Hex Nut	6-128
Bushing	6-139
Nut	6-140

**NATIONAL**

Assembly # 1-251	
Pin w/Cap	1-202
Cap	4-118
Spring	5-62
Push Nut	6-111

**FENESTRA**

Assembly # 1-133	
Pin w/Cap	1-132
Cap	4-115
Spring	5-51
E-Ring	6-112

**PEACHTREE**

Assembly # 1-220	
Cap	4-118
Clevis	6-103

**FENESTRA**

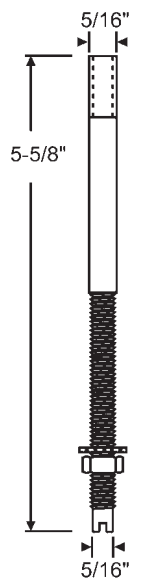
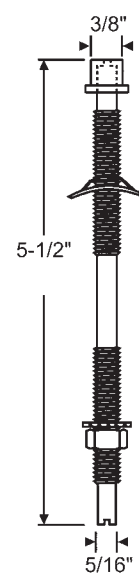
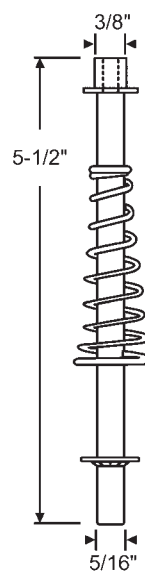
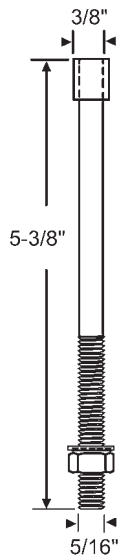
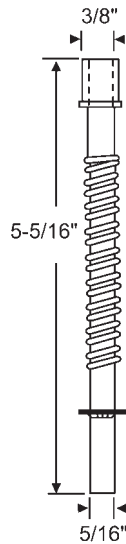
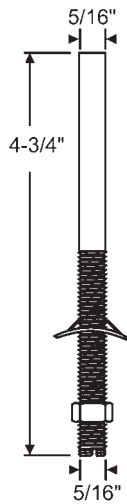

Assembly # 1-209	
Threaded Tinnerman	6-125
Hex Nut	6-128

**KELLER**

Assembly # 1-184	
Cap	4-103
Spring	5-50
Push Nut	6-111

**SLIMFOLD**

Assembly # 1-127	
Cap	4-110
Lock Washer	6-118
Hex Nut	6-128

Assembly # 1-252	
Pin w/Cap	1-261
Spring	5-62
Push Nut	6-111

Assembly # 1-123	
Cap	4-114
Tooth Lock Washer	6-118
Threaded Tinnerman	6-125
Hex Nut	6-128

**BENCHMARK**

Assembly # 1-195	
Pin w/Cap	1-194
Cap	4-126
Hex Nut	6-128
Tooth Lock Washer	6-118

**FLOATAWAY**

# CLOSET DOOR HARDWARE

## BI-FOLD CLOSET DOOR PIN ASSEMBLIES

### 5/16" DIAMETER

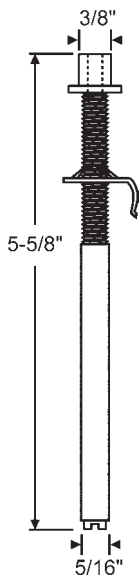

Assembly # 1-174	
Cap	4-117
Threaded Tinnerman	6-145

**SLIMFOLD**

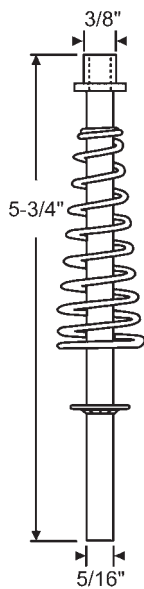

Assembly # 1-176	
Pin w/Cap	1-175
Cap	4-119
Spring	5-51
Push Nut	6-111

**FENESTRA**

### 3/8" DIAMETER

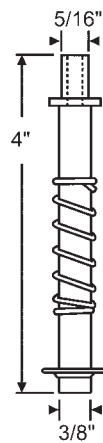

Assembly # 1-257	
Cap	4-130
Spring	5-60
Push Nut	6-100

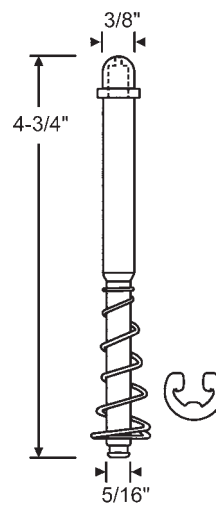

Assembly # 1-129	
Pin w/Cap	1-128
Cap	4-116
Spring	5-58
E-Ring	6-112

**FLOATAWAY**

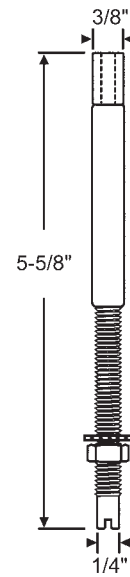

Assembly # 1-101	
Pin w/Cap	1-100
Cap	4-101
Hex Nut	6-128
Tooth Lock Washer	6-118

**FLOATAWAY**

## PEACHTREE/FLOATAWAY

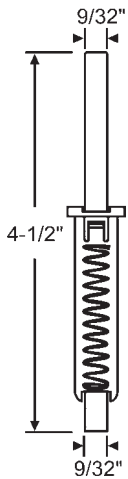

Assembly # 1-107

**PEACHTREE  
FLOATAWAY**

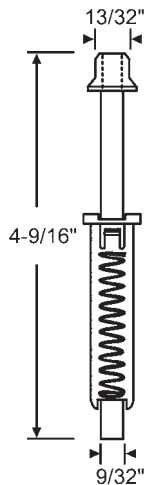

Assembly # 1-108	
Cap	4-127

**PEACHTREE  
FLOATAWAY**

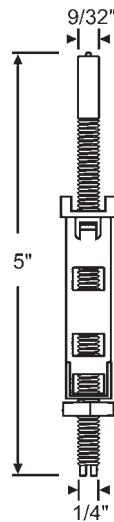

Assembly # 1-106	
Hex Nut	6-128
Pin Sleeve	8-308

**PEACHTREE  
FLOATAWAY**

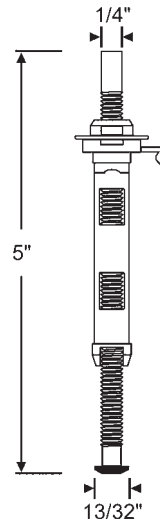

Assembly # 1-103	
Square Nut	6-157
Speed Nut	6-161
Pin Sleeve	900-6656

**FLOATAWAY**

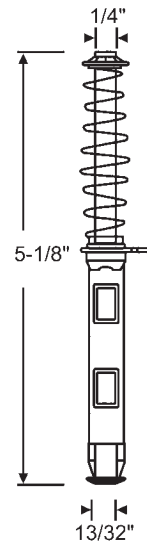

Assembly # 1-104	
Spring	5-59
Push Nut	6-122

**FLOATAWAY**

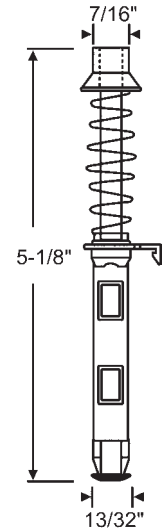

Assembly # 1-105	
Cap	4-106
Spring	5-59

**FLOATAWAY**

# CLOSET DOOR HARDWARE

## BI-FOLD CLOSET DOOR CAPS

Caps Shown Actual Size

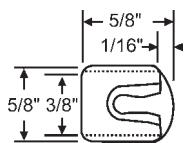

**4-100**  
5/16" Thick  
Fits Pin 1-151  
**LEIGH/MONARCH**

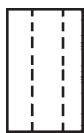

**4-101**  
Fits Pins 1-100, 1-149, 1-101,  
1-232, 1-148  
**FLOATAWAY**

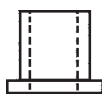

**4-103**  
Fits Pins 1-183, 1-184  
**SLIMFOLD**

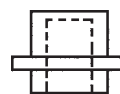

**4-104**  
Fits Pins 1-162, 1-171, 1-163,  
1-172, 1-172K  
**LEIGH/MONARCH**

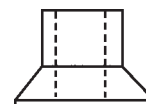

**4-106**  
Fits Pins 1-105, 900-9422  
**FLOATAWAY**



**4-107**  
Fits Pins 1-156, 1-157  
**NATIONAL**

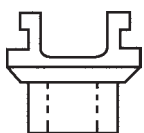

**4-108**  
Fits Pins 1-130, 1-131  
**NATIONAL**



**4-111**  
Fits Pins 1-145, 1-188, 1-226  
1-144A, 1-145A  
**LEIGH/MONARCH**

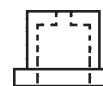

**4-114**  
Fits Pins 1-170, 1-123,  
1-235, 1-169, 1-237  
**BENCHMARK**



**4-115**  
Fits Pins 1-132, 1-159, 1-133,  
900-14476, 900-17552, 1-223,  
1-158, 1-224, 1-262, 900-8841A  
**PEACHTREE**

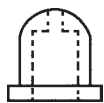

**4-116**  
Fits Pins 1-128, 1-228,  
1-129, 1-229  
**FLOATAWAY**

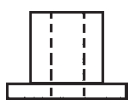

**4-117**  
Fits Pins 1-174, 1-197,  
1-232, 1-261  
**SLIMFOLD**

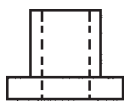

**4-119**  
Fits Pins 1-136, 1-175,  
1-204, 1-230, 1-137, 1-176,  
1-205, 1-236, 1-200, 1-217,  
1-238, 1-143, 1-201, 1-218,  
1-260, 1-269, 1-273, 1-243,  
1-244, 1-250, 1-259  
**FENESTRA**

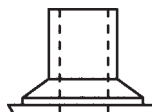

**4-120**  
Fits Pin 1-102  
**SLIMFOLD**

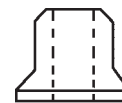

**4-127**  
Fits Pins 1-108  
**PEACHTREE**



**4-129**  
Fits Pin 1-246  
**PEACHTREE**

## BI-FOLD CLOSET DOOR SPRINGS

In Order by Height



**5-73**  
**BAYFORM**

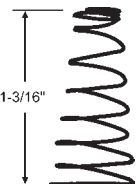

**900-9421S**

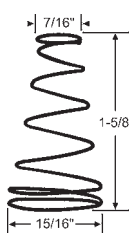

**5-62**  
**SLIMFOLD**

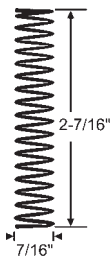

**5-50**  
**BENCHMARK**

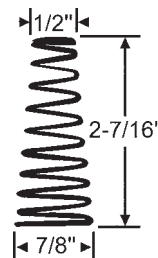

**5-51**

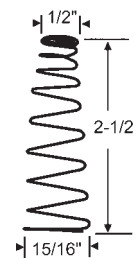

**5-63**

## BI-FOLD CLOSET DOOR ACCESSORIES

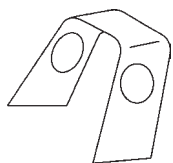

**6-101**  
Compression Retainer for  
1/4" Pins. Used with 1-224,  
1-237, 1-269, 1-273



Actual Size

**6-136**  
Hairpin Clip. Used with  
1-144A, 1-145, 1-145A,  
1-153, 1-153A, 1-163

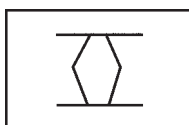

Actual Size

**6-143**  
1/4" Tinnerman Clip

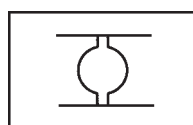

Actual Size

**6-125**  
5/16" Threaded Tinnerman



Part #	Size
6-112	1/4"
6-110	5/16"
6-109	3/8"

E-Ring



Part #	Size
6-122	1/4"
6-111	5/16"

Push Nut

# CLOSET DOOR HARDWARE

## METAL CLOSET DOOR PIVOT BRACKETS

In Order by Length

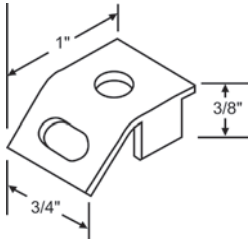

**7-240**  
Metal  
**LEIGH/MONARCH**

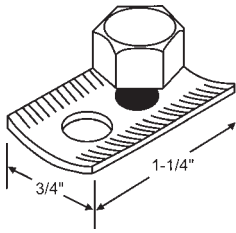

**7-234**  
Metal  
**LEIGH/MONARCH**

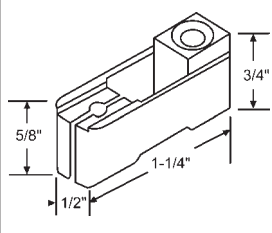

**7-225**  
Nylon  
**PEACHTREE**

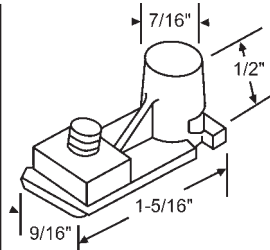

**7-246**  
Nylon  
**PEACHTREE**

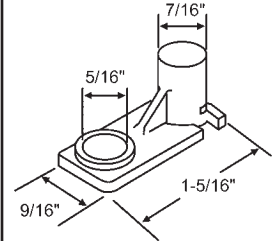

**7-227**  
Nylon

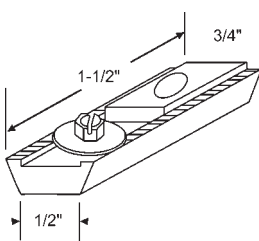

**7-210A**  
Nylon  
**NATIONAL**

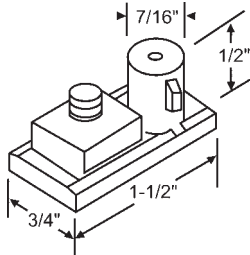

**7-230**  
Nylon  
**PEACHTREE**

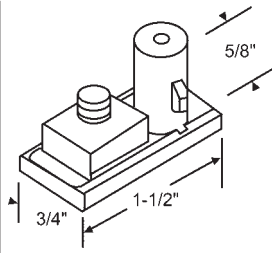

**7-247**  
Nylon  
**BENCHMARK**

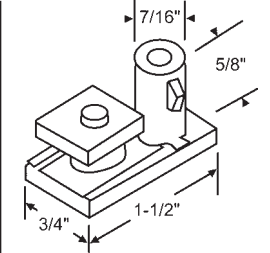

**7-229**  
Nylon  
**PEACHTREE**

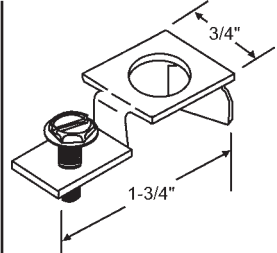

**7-226**  
Metal  
**BENCHMARK**

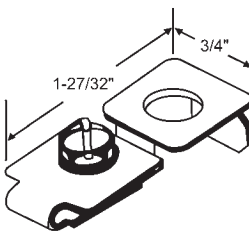

**7-200**  
Metal  
**SLIMFOLD**

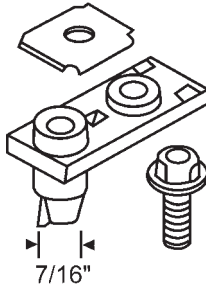

**7-223**  
Nylon  
**FLOATAWAY**

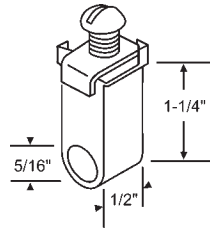

**7-224**  
Nylon

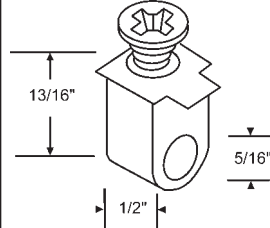

**7-231**  
Nylon  
New Style  
**SLIMFOLD**

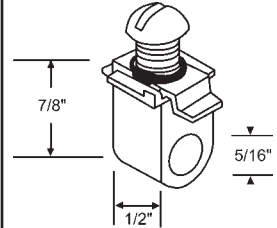

**7-2310S**  
Nylon  
Old Style  
**SLIMFOLD**

## METAL CLOSET DOOR NYLON GROMMETS/BUSHINGS/BUMPERS

In Order by Height

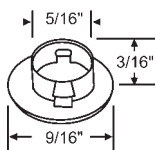

**8-255**  
**NATIONAL**

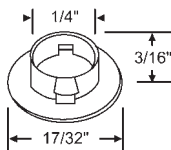

**8-254**  
**NATIONAL**

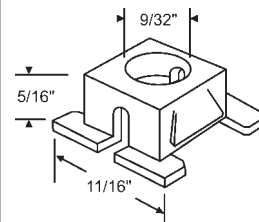

**8-262**  
**PEACHTREE**

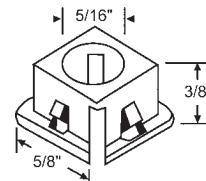

**8-268**  
**PEACHTREE**

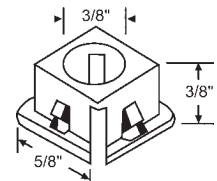

**8-269**  
**PEACHTREE**

# CLOSET DOOR HARDWARE

## METAL CLOSET DOOR NYLON GROMMETS/BUSHINGS/BUMPERS

In Order by Height

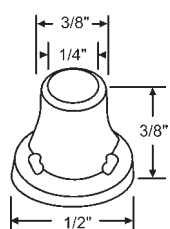

**8-261**  
Blue  
**BENCHMARK**

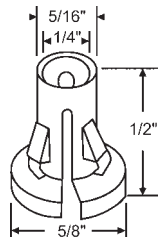

**8-264**  
**FLOATAWAY**

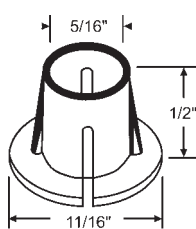

**8-267**  
**FLOATAWAY**

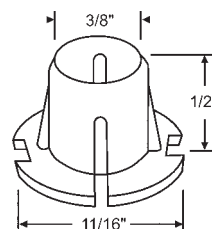

**8-280**  
**FLOATAWAY**

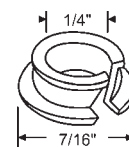

**8-259**  
**LEIGH/MONARCH**

In Order by Length

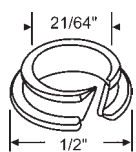

**8-260**  
**LEIGH/MONARCH**

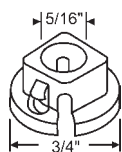

**8-266**  
**FLOATAWAY**

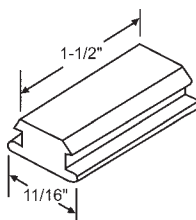

**8-271**  
Gray  
**NATIONAL**

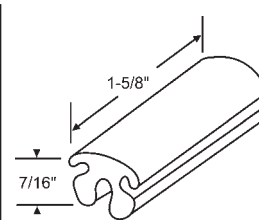

**8-304**  
White  
**FLOATAWAY**

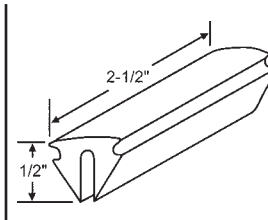

**8-283**  
White  
**BENCHMARK**

## METAL CLOSET DOOR PLATES & PULLS

In Order by Diameter & Height

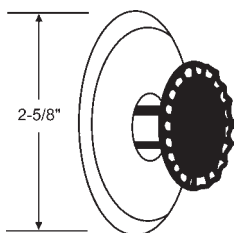

Part #	Finish
8-228B	Bronze
8-228A	Polished Aluminum

**FLOATAWAY**

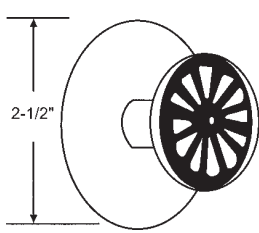

**8-258**  
Brass with Screw  
8-327 Knob, 8-321 Back Plate  
**SLIMFOLD**

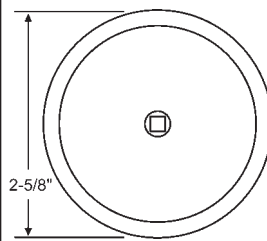

Part #	Finish
900-10221C	Chrome
900-10221	Polished Brass
900-10221SNK	Satin Nickel

Back Plate

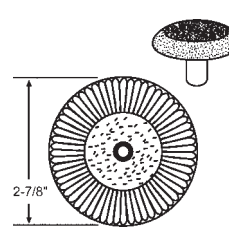

**8-289**  
Antique Brass  
Adhesive Pad Only: 900-13008  
**BENCHMARK**

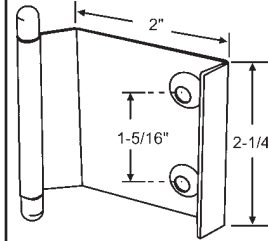

Part #	Finish
8-278	Chrome
8-278B	Gold

Door Pull Set  
**SLIMFOLD**

## BI-FOLD DOOR HINGE

## CLOSET DOOR TRACK

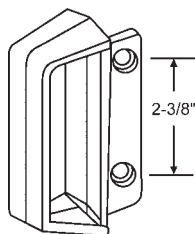

**8-305**  
White  
**PEACHTREE FLOATAWAY**

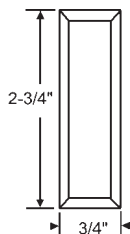

**900-16101-1**  
Gray Mirror Pull  
Self Adhesive

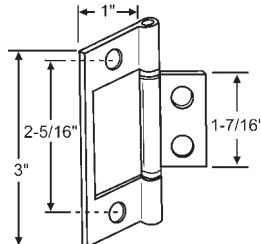

**900-820**  
Brass Plated Steel

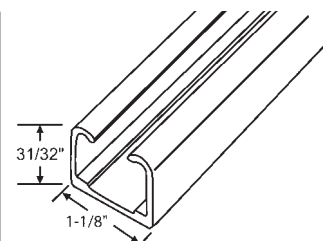

Part #	Size
8-467-3	3'
8-467-4	4'
8-467-6	6'

**KENNAFRAME**

# CLOSET DOOR HARDWARE

## WOOD CLOSET DOOR PLUNGER PINS, BRACKETS, PLATES & CAPS

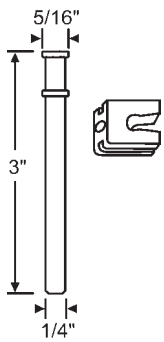

Assembly # 1-246

Guide Cap	4-129
-----------	-------

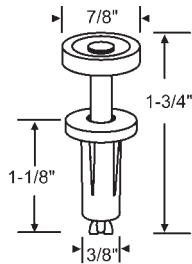

**2-104**

Top Rolling Guide  
Spring Loaded

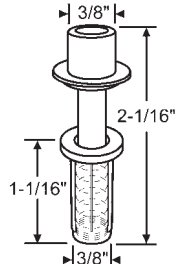

**2-122**

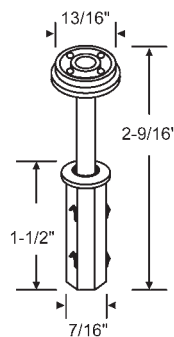

**2-109**

**OLD STANLEY**

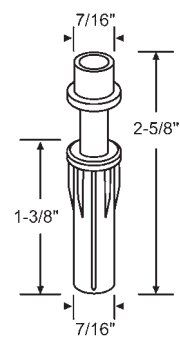

**2-76**

4-125 Cap Only

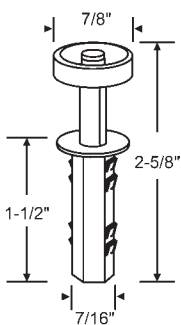

**2-58**  
**ACME**

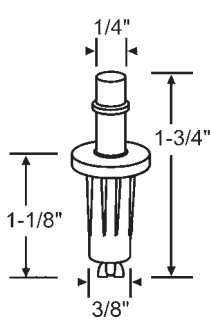

**2-113**

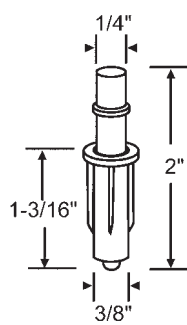

**2-105**

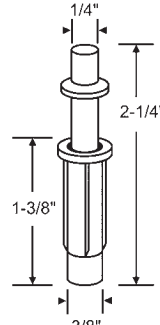

**2-110**  
**ALLIANCE**

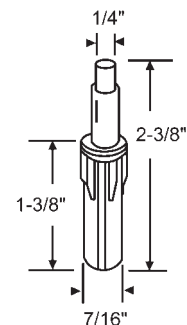

**2-77**

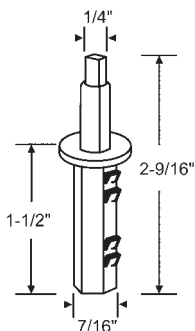

**2-60**

Use with 2-92

**ACME**

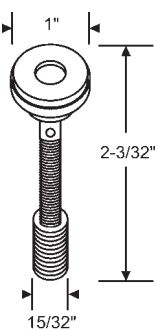

**2-112**

8-281 Bushing Only  
2-111 Pin Only

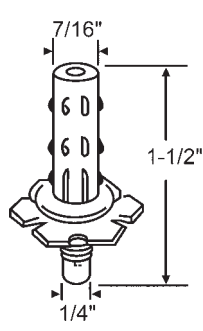

**2-78**

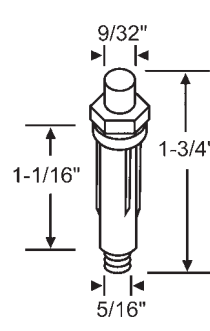

**2-106**

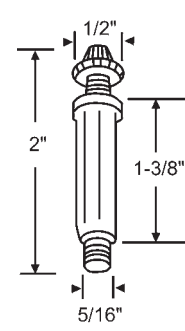

**2-121**

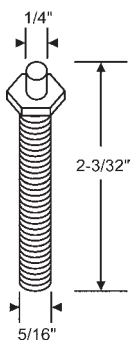

**2-116**

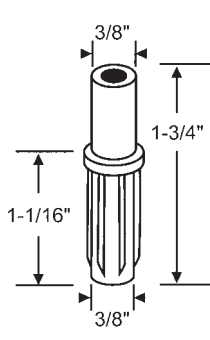

**2-62**

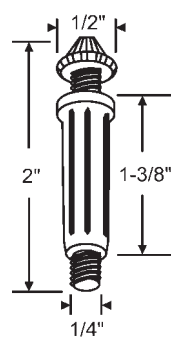

**2-63**

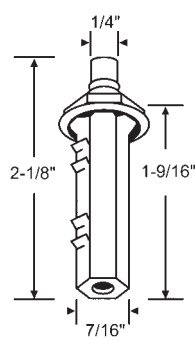

**2-59**  
**ACME**

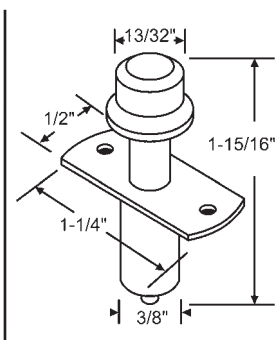

**2-95**  
**HARVEY**



# CLOSET DOOR HARDWARE

## WOOD CLOSET DOOR PLUNGER PINS, BRACKETS, PLATES & CAPS

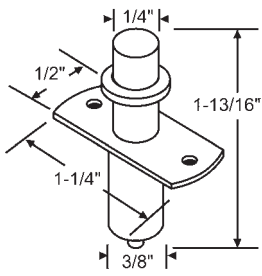

**2-85**

**HARVEY**

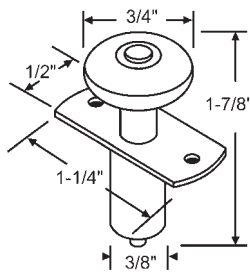

**2-52**

**HARVEY**

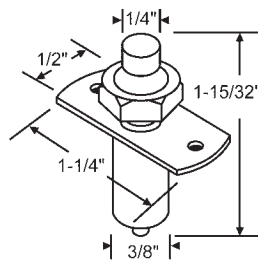

**2-97**

**HARVEY**

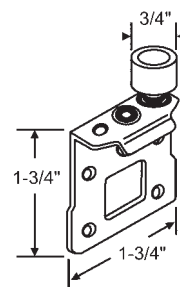

Part #	Hand
2-66	Shown
2-65	Opposite

**PANIFLEX**

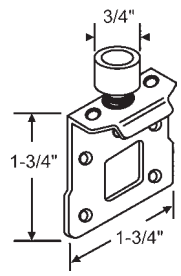

**2-67**

**PANIFLEX**

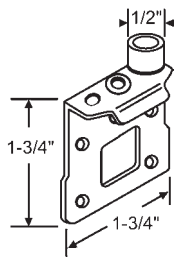

Part #	Hand
2-71	Shown
2-70	Opposite

**PANIFLEX**

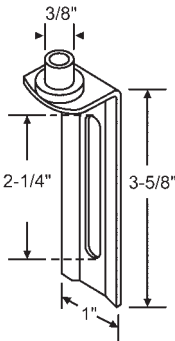

**2-94**

Includes Attaching  
Screws 1/4" - 20" x 1/2"

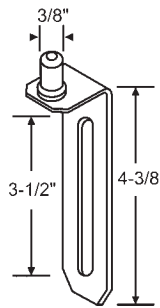

**2-118**

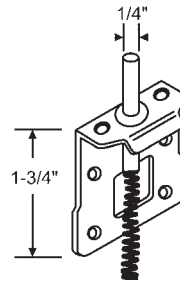

**2-68**

**PANIFLEX**

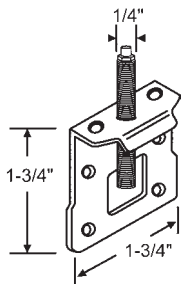

**2-69**

**PANIFLEX**

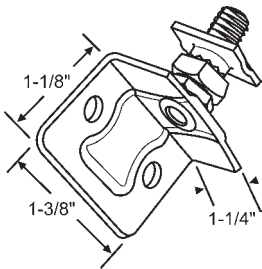

**900-808-OS**

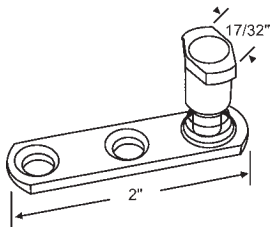

**2-108**

**STANLEY**

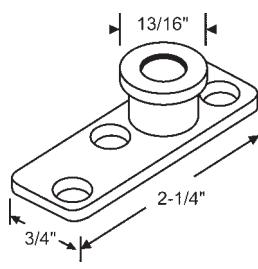

**2-50**

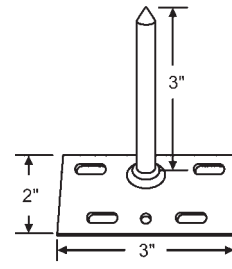

**2-120**

Top Plate. Use with 8-338

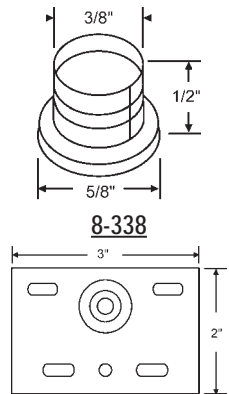

**8-338**

**7-253**

Bottom Plate

## CLOSET DOOR ROLLERS

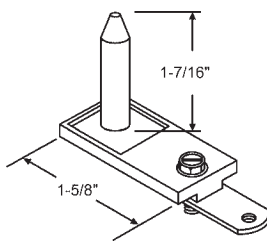

**900-10518**

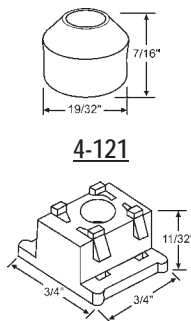

**4-121**

**4-124**

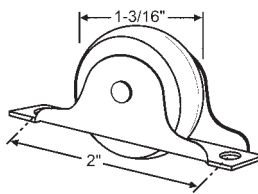

**3-351**

Nylon Wheel

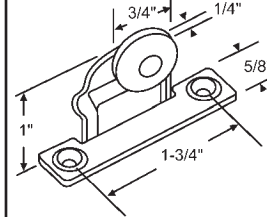

**3-219**

Nylon Wheel  
**HARVEY**

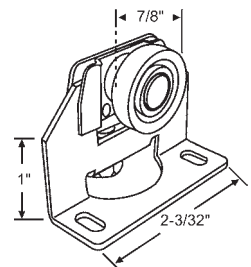

**3-151**

# CLOSET DOOR HARDWARE

## WOOD CLOSET DOOR BY-PASS HANGERS

In Order by Roller Diameter

### 3/4" Roller

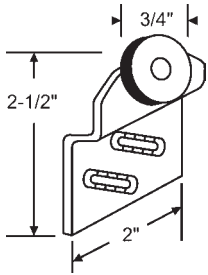

**3-165**  
1/4" Offset  
**E-Z ROLL**

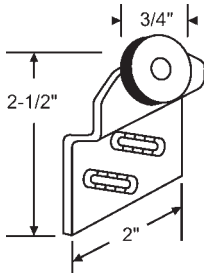

**3-164**  
1/2" Offset  
**E-Z ROLL**

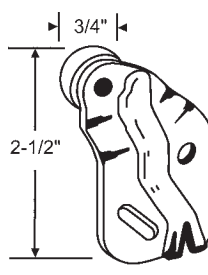

**3-190**  
1/4" Offset  
**E-Z ROLL**

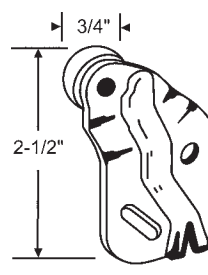

**3-191**  
1/2" Offset  
**E-Z ROLL**

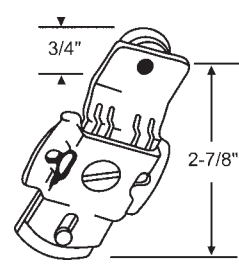

**3-170**  
1/4" Offset

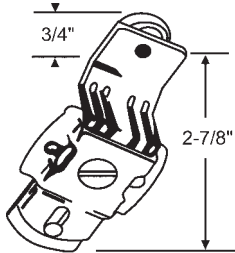

**3-171**  
1/2" Offset

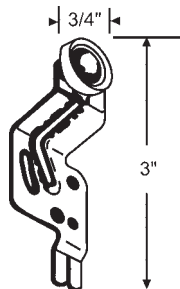

**3-203**  
3/4" Offset  
w/ Screws

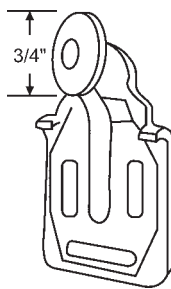

**900-21054**  
3/4" Offset  
900-21054S for Hanger w/Screws

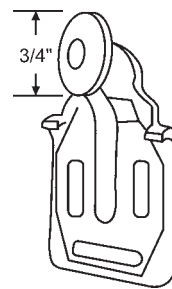

**900-7798**  
3/8" Offset  
900-7798S for Hanger w/Screws

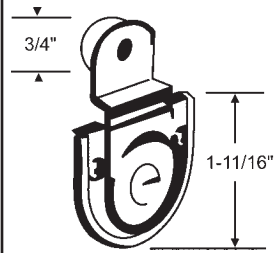

**3-206**  
1/8" Offset  
**LAWRENCE**

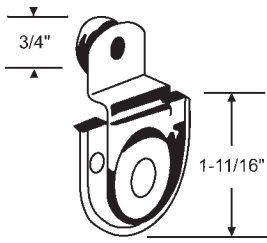

**3-185**  
1/2" Offset  
**LAWRENCE**

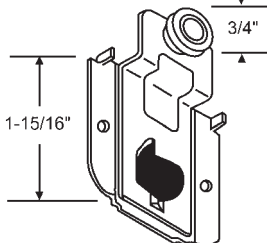

**3-172**  
1/4" Offset  
**GRANT**

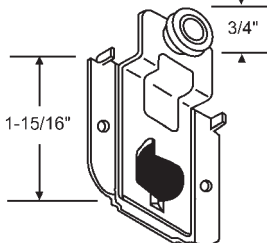

**3-173**  
1/2" Offset  
**GRANT**

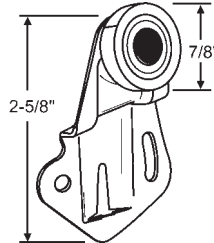

**3-339**  
3/8" Offset Universal Hanger

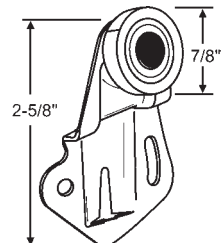

**3-340**  
1/16" Offset Universal Hanger

### 27/32" Roller

Roller to Bracket  
Face Clearance

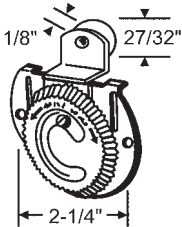

**3-199**  
1/16" Offset  
**OLD STANLEY**

Roller to Bracket  
Face Clearance

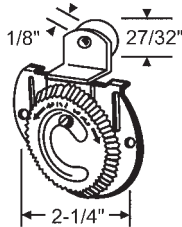

**3-198**  
3/8" Offset  
**OLD STANLEY**

### 7/8" Roller

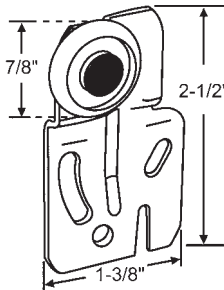

**3-152**  
1/4" Offset  
**ACME**

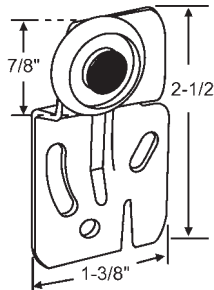

**3-153**  
1/2" Offset  
**ACME**

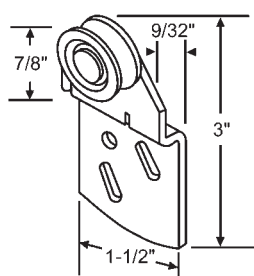

**3-107**  
9/32" Offset  
3-107S for Hanger with Screws

# CLOSET DOOR HARDWARE

## WOOD CLOSET DOOR BY-PASS HANGERS

### 7/8" Roller

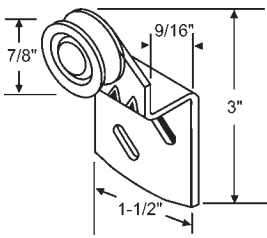

**3-108**  
9/16" Offset  
3-108S for Hanger with Screws

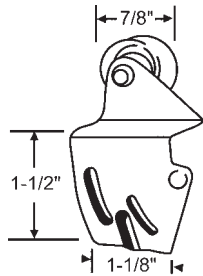

**3-147**  
3/8" Offset

### 31/32" Roller

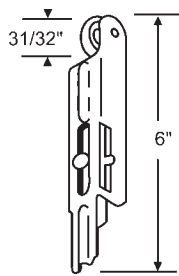

Part #	Hand
3-202	Shown
3-201	Opposite

### 1" Roller

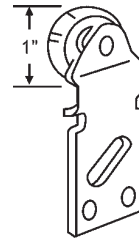

**900-1304**  
Front Hanger w/Ball Bearing Wheel, 1/16" Offset  
**E-Z ROLL**

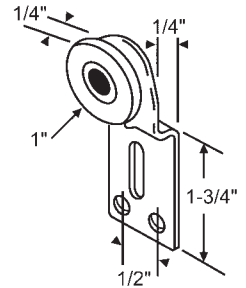

**3-212**  
Front Hanger  
**COX**

### 1-3/16" Roller

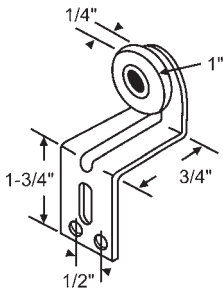

**3-211**  
Rear Hanger  
**COX**

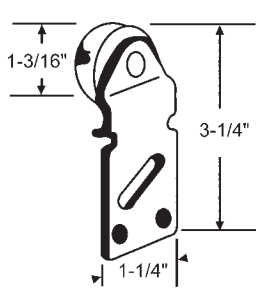

**3-193**  
1/16" Offset

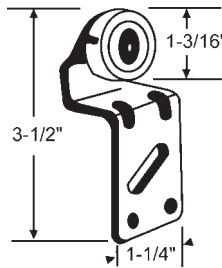

**3-195**  
1-3/8" Offset

### 1-3/8" Roller

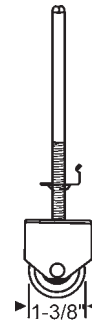

**900-12272N**  
New Style

### WOOD CLOSET DOOR BY-PASS HANGERS - 2-WHEEL

#### 13/16" Rollers

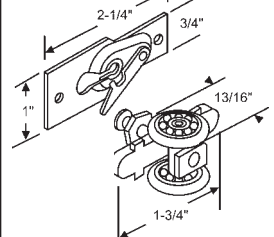

**900-10534**  
Ball Bearing Wheels

### 7/8" Rollers

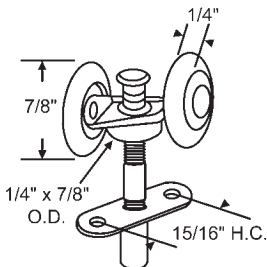

**3-223**

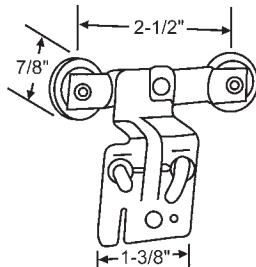

**3-113**  
w/ Screws  
1/4" Offset

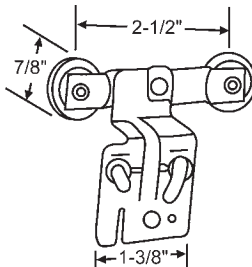

**3-112**  
w/ Screws  
1/2" Offset

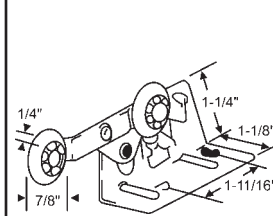

**3-213**

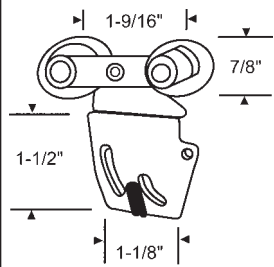

**3-143**  
3/8" Offset

### WOOD CLOSET DOOR BY-PASS HANGERS - 3-WHEEL

#### 3/4" Rollers

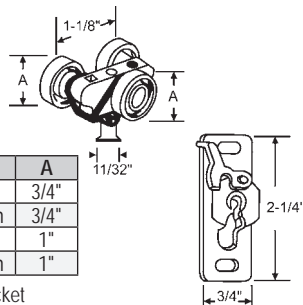

Part #	Wheel Type	A
3-141	Nylon	3/4"
3-141BB	Ball Bearing Nylon	3/4"
3-140	Nylon	1"
3-140BB	Ball Bearing Nylon	1"

Comes with 8-226 Bracket

### WOOD CLOSET DOOR BY-PASS HANGERS - 4-WHEEL

#### 23/32" Rollers

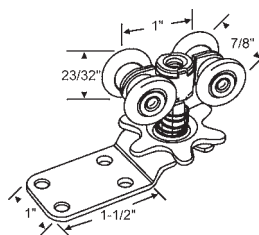

**3-126**

#### 3/4" Rollers

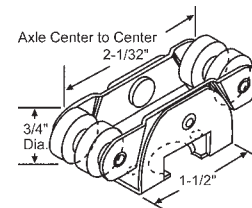

**900-569**

#### 13/16" Rollers

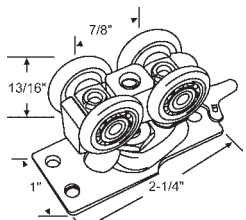

**900-9746**

# CLOSET DOOR HARDWARE

## WOOD CLOSET DOOR BY-PASS HANGERS - 4-WHEEL

7/8" Rollers

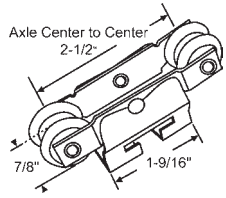

**900-803-OS**

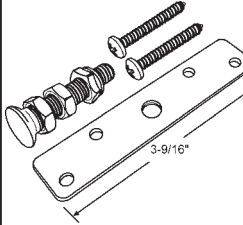

**900-586**

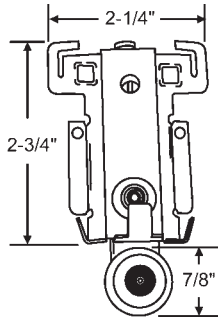

**3-120**

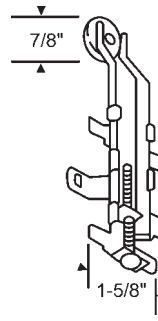

**3-133**

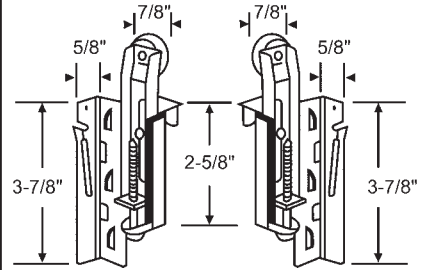

**3-122A**

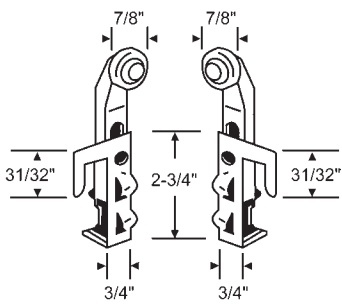

**3-116A**  
**ACME**

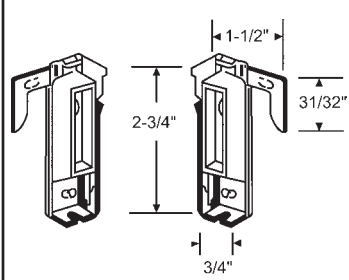

**3-118A**  
**ACME**

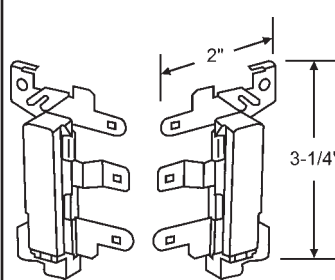

**3-156A**  
**COX**

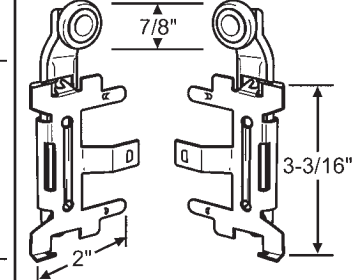

**3-158A**  
Corner Connector Hanger Set  
**COX**

## WOOD CLOSET DOOR PIVOT/JAMB BRACKETS

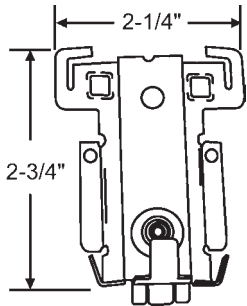

**3-121**

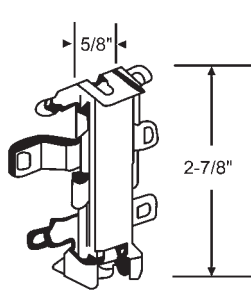

**3-132**

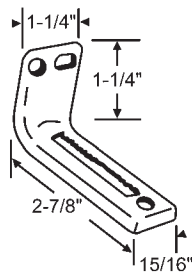

**7-221**  
Metal

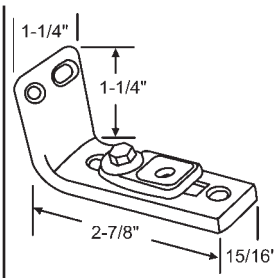

**7-222**  
Metal with Nylon Insert  
7-222-2 For 2 Brackets w/Screws

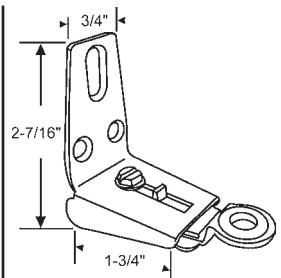

**7-205**  
Metal

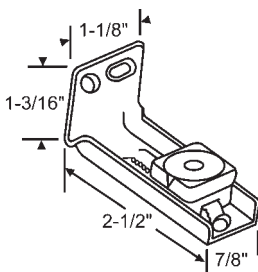

**7-241**  
Metal with Nylon Insert

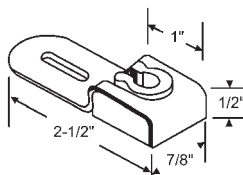

**7-212**  
Metal with Nylon Insert

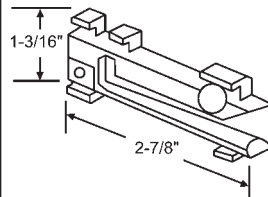

**7-235A**  
Sold as Set (1 Left Hand, 1 Right Hand). Nylon  
**PANIFLEX**

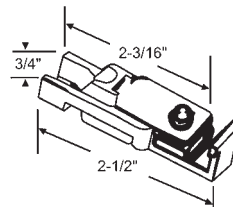

**7-215**  
Nylon with Metal Insert

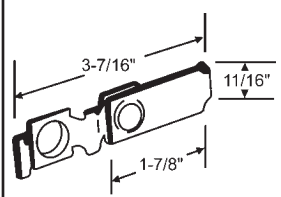

**7-216**  
Metal

# CLOSET DOOR HARDWARE

## WOOD CLOSET DOOR PIVOT/JAMB BRACKETS

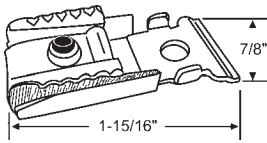

**7-237**  
Metal  
**ACME**

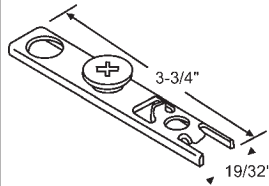

**7-220N**  
Metal (New Style)

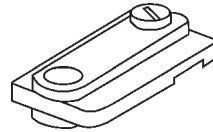

**7-254**  
Bracket Only

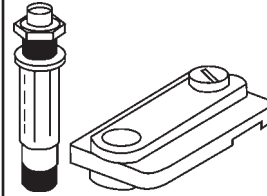

**7-254A**  
Bracket with Plunger Pin

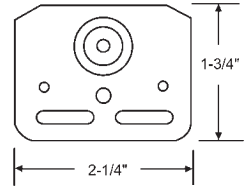

**7-201**  
Metal  
**PANIFLEX**

## WOOD CLOSET DOOR PULLS & KNOBS

In Order by Type, then Outside Diameter

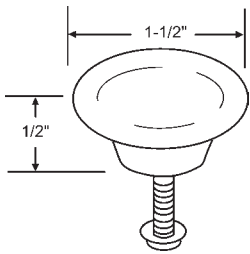

Part #	Finish
8-300	Brass Plated
8-300C	Chrome Plated
8-300SNK	Satin Nickel

Die Cast

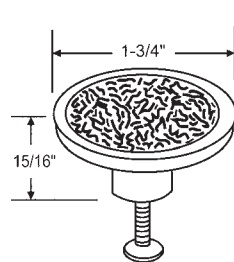

**8-298**  
Plastic, Brown

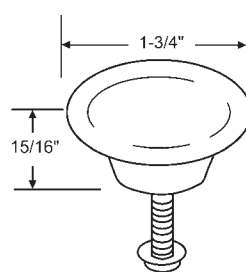

**8-235**  
Wood, Unfinished

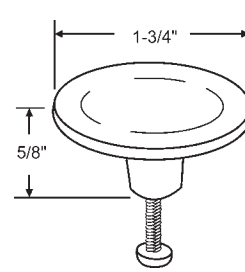

Part #	Finish
8-301	Brass Plated
8-301C	Chrome Plated
8-301SNK	Satin Nickel

Die Cast

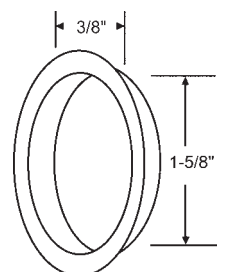

**900-793**  
Nylon, Tan  
Flush

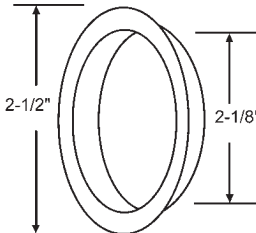

Part #	Finish
8-202	Brass Plated
8-202AB	Antique Brass Plated
8-202C	Chrome Plated

Die Cast

**E-Z ROLL**

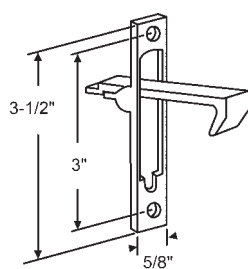

**900-790**  
Metal, Bright Brass Finish  
Flush Mount Edge Pull

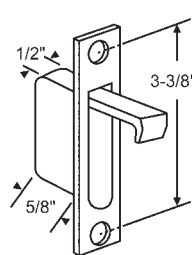

**900-43**  
Metal, Aluminum Finish

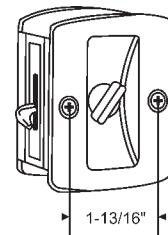

**900-14604**  
Stamped Steel Combination Door  
Pull and Privacy Lock Adjusts for  
1-3/8" to 1-3/4" Doors.  
Polished Brass Finish

## WOOD CLOSET DOOR FLOOR GUIDES/PLATES

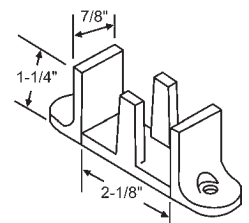

**8-245**  
Adjusts for Doors 7/8" - 1-7/8"  
Nylon

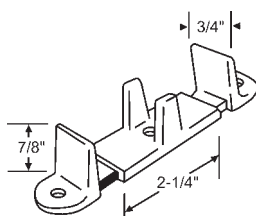

**8-294**  
Adjusts for Doors 3/4" - 1-3/4"  
Nylon, Tan - Includes Screws

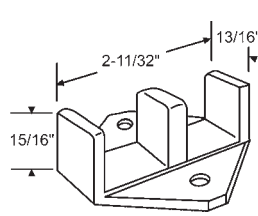

**8-314**  
Nylon, 1 Piece. Fits 3/4" Doors  
**E-Z ROLL**

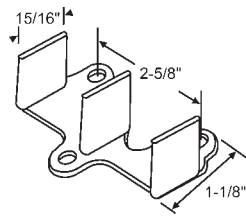

**900-8114**  
Nylon  
1 Piece. Fits 1-3/8" Doors

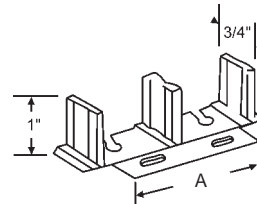

Part #	A	Adjusts for Doors
8-231	2-3/4"	3/4" - 1-3/8"
8-232	3-1/2"	1/8" - 1-3/4"

Metal w/Nylon Post. Wood Tone.

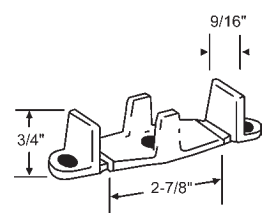

**8-240**  
Nylon, White. Adjusts for Doors  
3/4" - 1-3/4"  
**E-Z ROLL**

# CLOSET DOOR HARDWARE

## WOOD CLOSET DOOR FLOOR GUIDES/PLATES

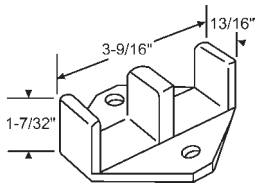

**8-291**

1 Piece. Floor Guide to Fit  
1-3/8" Double Doors 1-1/4"  
High from Floor  
**E-Z ROLL**

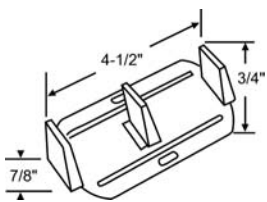

**8-315**

Metal with Nylon Posts  
For 1-3/4" Doors

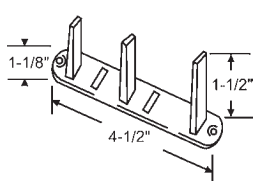

**8-330**

Metal with Nylon Posts  
Adjusts for Doors 3/4" - 1-3/8"

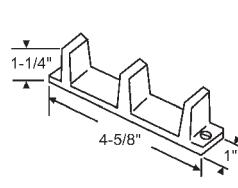

**8-208**

One Piece Nylon with Fixed  
Guides for 1-3/8"  
By-Passing Doors

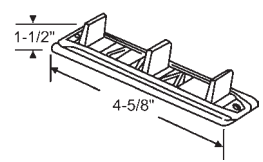

**8-209-4**

Metal with Nylon Posts.  
Adjustable for 3/4", 1", 1-1/8" and  
1-3/8" By-Passing Doors  
4 per pack with Screws.

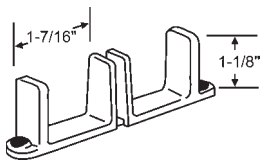

**8-316**

Nylon  
Adjustable For 1-3/8" By-Passing  
Doors 2 pieces  
**E-Z ROLL**

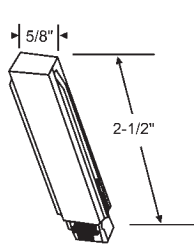

**8-296**

Nylon Insert Guide

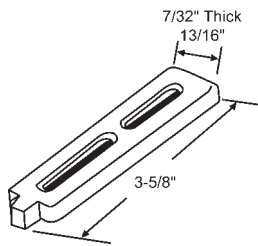

**8-295**

Guide Stem  
**PANIFLEX**

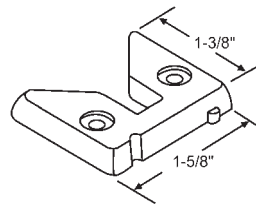

**900-849**

Nylon. Floor Plate (Single)  
**PANIFLEX**

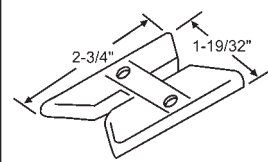

**900-848**

Nylon. Floor Plate (Double)  
**PANIFLEX**

### PIVOT GUIDE

### WOOD CLOSET DOOR SNUGGERS

### BUMPERS

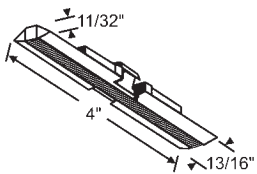

**2-92**

Pivot Guide  
**STANLEY**

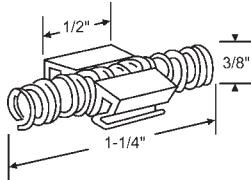

**8-213**

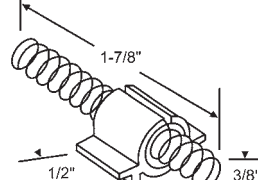

**8-203**

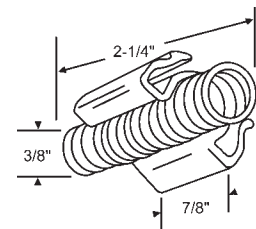

**8-217**

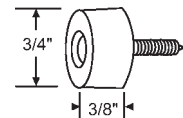

**8-246**

White Rubber Door Bumper  
with Screw

## CLOSET DOOR MISCELLANEOUS ACCESSORIES

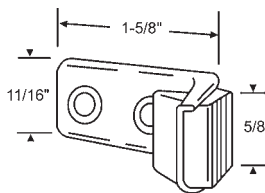

**8-224**

Metal Angle Stop  
w/Rubber Bumper  
**STANLEY**

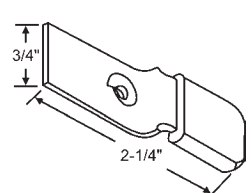

**8-204**

Closet Door Guide  
Metal with Rubber Sleeve

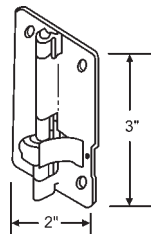

**8-230**

Door Hinge  
**PANIFLEX**

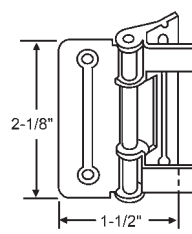

**8-236**

Door Hinge

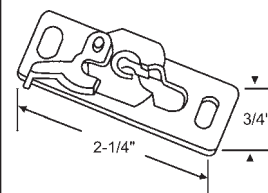

**8-226**

Mounting Brackets  
for 3-141 Rollers

# CLOSET DOOR HARDWARE

## CLOSET DOOR MISCELLANEOUS ACCESSORIES

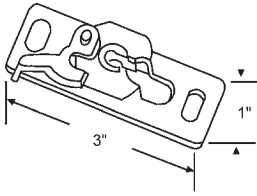

**8-227**  
Mounting Brackets  
for 3-139 and 3-140 Rollers

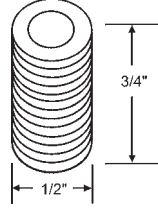

**8-281**  
Threaded Bushing  
Use with 2-112 Plunger Pin

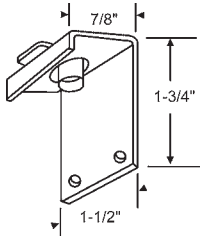

**8-326**  
Adapter Plate

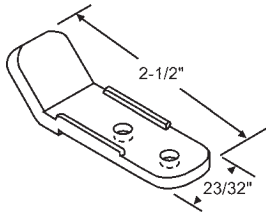

**900-847**  
Aligner  
**PANIFLEX**

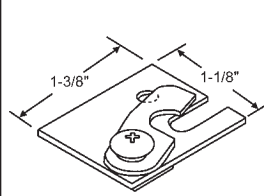

**900-8986**  
Cam Lock Assembly

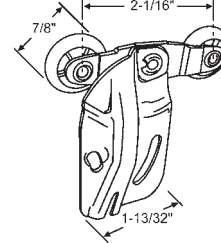

**900-656**  
Front Dual Wheel Hanger

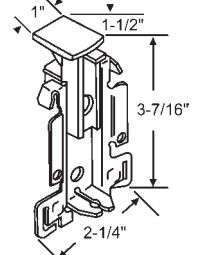

**900-12459**  
Top Guide

## BI-FOLD DOOR REPAIR BRACKET

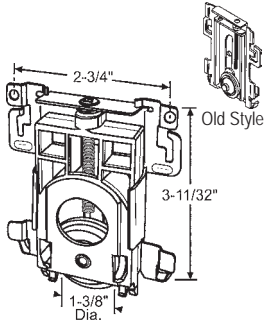

**900-11827**  
Bottom Roller

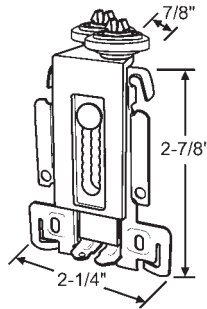

**3-386**  
Mirror Door Top Guide. 2 Rubber  
Wheels

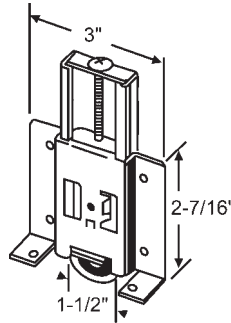

**3-227**  
1-1/2" All Nylon Roller

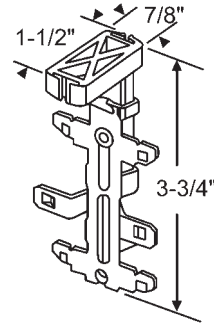

**3-228**  
Guide Bracket

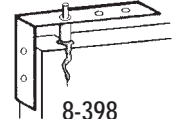

**8-398**

Repair split bifold door. Repair loose pivot pins. Fits all bifold doors. No drilling required attaches in minutes. Heavy metal bracket pulls a split bifold door together. Loose pivot pins welded permanently in place. Repair bracket lasts for years and years. Simply screw bracket onto the edge of split door. Not visible when installed.

## CLOSET DOOR SAVERS

A way to repair bifold doors in minutes. Anyone who has wooden bifold doors knows the difficulty involved in repairing broken or cracked pin holes. The Closet Door Saver will quickly and economically repair a broken corner and make it sturdier than the original door. The beauty of the Closet Door Saver is the ease of installation. Simply drill a 7/8" hole over the original pin hole. Slide the Closet Door Saver over the broken corner and insert the door pin. Fasten by screws or construction adhesive. Your Door is Now Permanently repaired! Closet Door Savers are constructed of durable plastic.

### Closet Door Saver

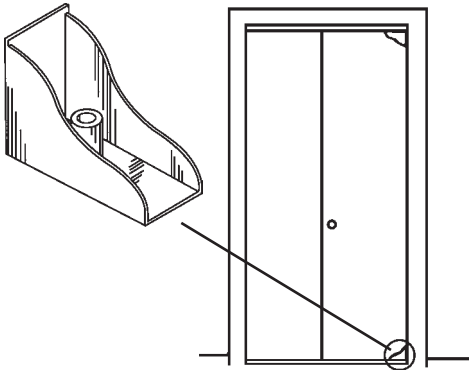

Part #	Finish
900-19405	Light Oak
900-19405D	Dark Oak
900-19405W	White

### Single Sided Closet Door Saver

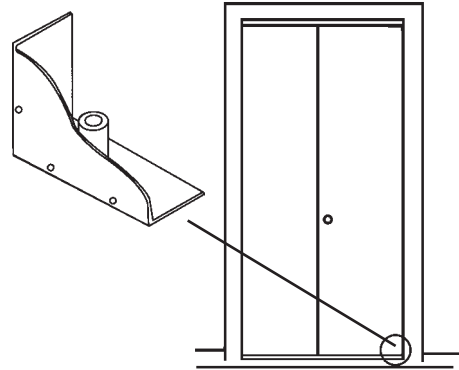

Part #	Finish
8-404	Light Oak
8-404D	Dark Oak
8-404W	White

# CLOSET DOOR HARDWARE

## BI-FOLD DOOR TRACK SETS



Includes the Following:

1. Roll form steel painted white top track.
2. Hardware bag includes 3/8" top and bottom pivots, top and bottom brackets, hinges, aligners, wood knobs, snugger and screws.
3. Instruction sheet.

Sold by the set in multiples of 5.

For use with 1" to 1-3/8" solid wood doors weighing up to 30lbs. each

Part Number	Length	Doors
8-562-4	4'	4
8-562-5	5'	4
8-562-6	6'	4

## CW MIRROR BY-PASS DOOR HARDWARE

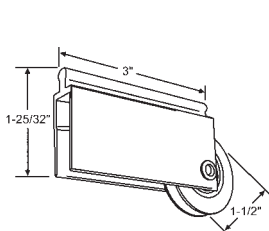

**900-8319**

Round-top Mirror Door Roller.  
Nylon Wheel  
**MONARCH**

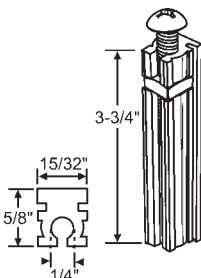

**900-10252**

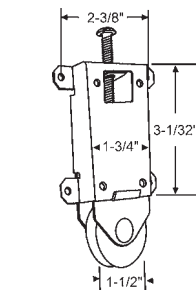

**3-348**

Wardrobe Door Bottom Roller with Angled Tang, Nylon Wheel

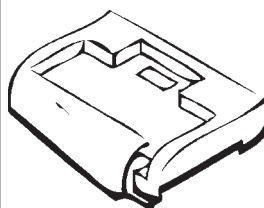

**7-280**

Plastic Top Guide

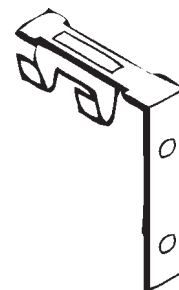

**7-281**

Metal Top Guide Bracket

## CW MIRROR BI-FOLD DOOR HARDWARE

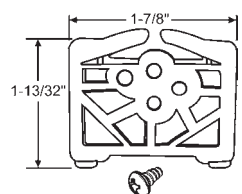

**900-21382**

Nylon Mirror Door Guide with Screw

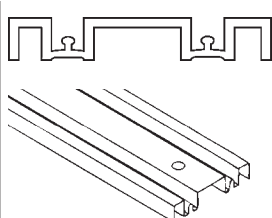

Part #	Length
8-636-5	5ft
8-636-6	6ft
8-636-8	8ft

Ultra Glide Track, 3" Wide Steel w/ Aztec Gold Finish.

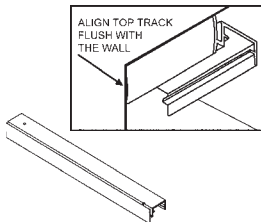

Part #	Length
8-635-5	5'
8-635-6	6'
8-635-8	8'

Top and Bottom Steel Track, 3" Wide

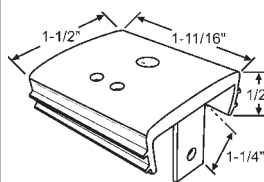

**8-645**

Mirror Door Guide & Bracket.  
Flexible Plastic Top Guide w/  
Steel Mounting Bracket  
**MONARCH**

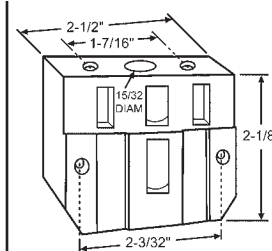

**8-647**

Corner Connector for Mirror Door

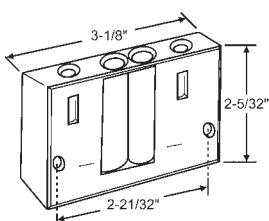

**8-324**

Corner Connector for Mirror Door

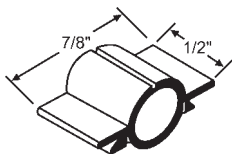

**8-634**

Tension Clip

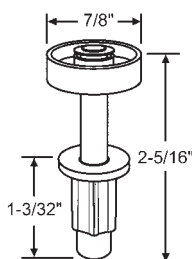

**2-142**

Guide Pin

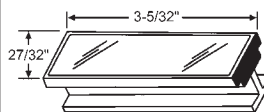

**8-633**

Mirror Handle

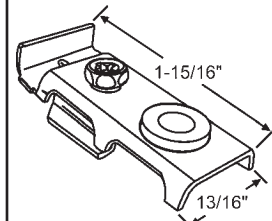

**7-279**

Pivot Block Clamp

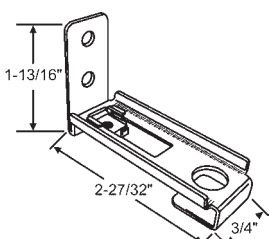

**7-278**

Pivot L-Bracket

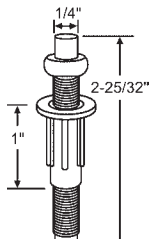

**2-143**

5/32" Female Hex Threaded Pivot

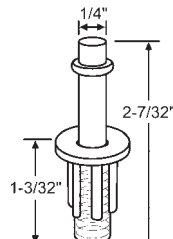

**2-144**

Top Spring Pivot Pin

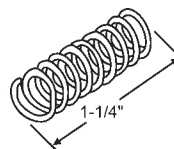

**5-120**

Small Spring

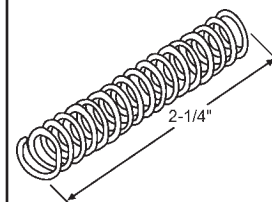

**5-121**

Large Spring



## E-Z ROLL SLIDING DOOR TRACK SETS

7000 Series Sliding Door Track Set for 3/4" and 1-3/8" by-passing doors up to 50 lbs. each

- Track Made of Extruded Aluminum
- Nylon Wheels for Smoother and Quieter Operation
- Simple Adjustment with Screwdriver
- Complete with All Necessary Hardware and Instruction Sheet
- Packed 3 Sets to a Master Carton

Part #	Description
7048HU	46-1/2" for 4' Opening
7060HU	58-1/2" for 5' Opening
7072HU	70-1/2" for 6' Opening

Aluminum Track Sets  
Packed and Sold Three Sets per Tube.  
Each Set Includes all Necessary Hardware.

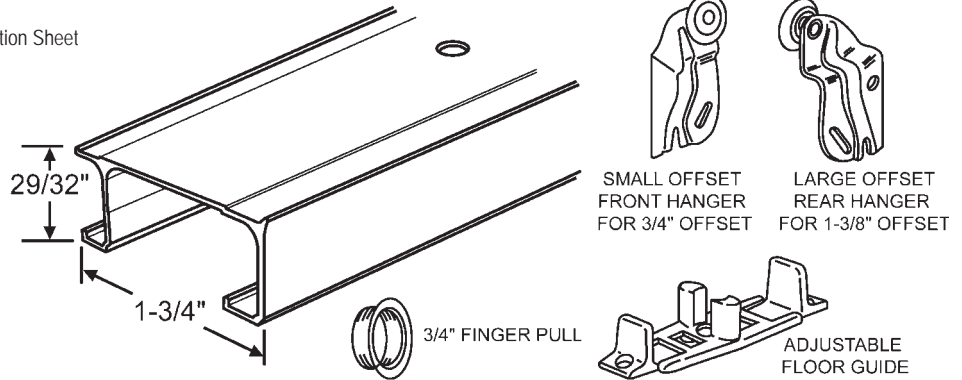

## E-Z ROLL UNIVERSAL HANGERS FOR SLIDING DOOR TRACK SETS

<p><b>3-193</b> Front Hanger w/Nylon Wheel, 1/16" Offset</p>	<p><b>3-194</b> Rear Hanger w/Nylon Wheel, 5/8" Offset</p>	<p><b>3-195</b> Rear Hanger w/Nylon Wheel, 1-3/8" Offset</p>	<p><b>900-1304</b> Front Hanger w/Ball Bearing Wheel, 1/16" Offset</p>	<p><b>900-1305</b> Rear Hanger w/Ball Bearing Wheel, 1-1/2" Offset</p>	<p><b>900-1308</b> Front Hanger w/Nylon Wheel, 1/16" Offset</p>
<p><b>900-1305N</b> Rear Hanger w/Nylon Wheel, 1-1/2" Offset</p>	<p><b>900-1306</b> Top Mounting Hanger for Single Pocket Door w/Ball Bearing Wheel</p>	<p><b>900-1307</b> Top Mounting Hanger for Single Pocket Door w/Nylon Wheel</p>	<p><b>900-1314</b> Screen &amp; Patio Door Hanger w/Nylon Wheel, 3/8" Offset</p>	<p><b>3-382</b> Front Hanger for Wardrobe w/Nylon Wheel, 1/8" Offset</p>	<p><b>3-381</b> Rear Hanger for Wardrobe w/Nylon Wheel, 3/8" Offset</p>
<p><b>3-165</b> Front Hanger w/Nylon Wheel, 1/4" Offset</p>	<p><b>3-164</b> Rear Hanger w/Nylon Wheel, 1/2" Offset</p>	<p><b>3-190</b> Front Hanger w/Nylon Wheel, 1/4" Offset</p>	<p><b>3-191</b> Rear Hanger w/Nylon Wheel, 1/2" Offset</p>	<p><b>900-1301</b> Front Hanger Twin Wheels, 1/4" Offset</p>	<p><b>900-1300</b> Rear Hanger Twin Wheels, 1/2" Offset</p>

# CLOSET DOOR HARDWARE

## E-Z ROLL UNIVERSAL HANGERS FOR SLIDING DOOR TRACK SETS

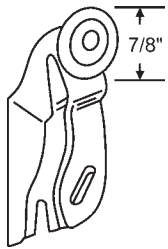

**900-1318**

Front Hanger w/Nylon Wheel, 3/16" Offset

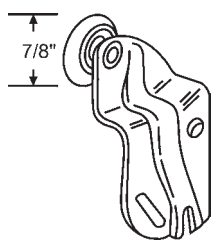

**900-1317**

Rear Hanger w/Nylon Wheel, 1/2" Offset

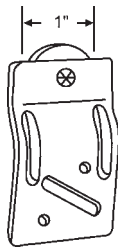

**900-1312**

Front Hanger 3/16" Offset

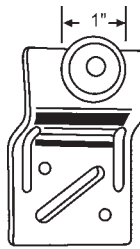

**900-1313**

Rear Hanger 1/2" Offset

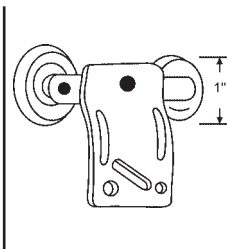

**900-1298**

Front Hanger Twin Wheel 3/16" Offset

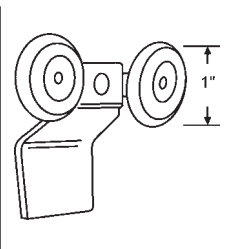

**900-1299**

Rear Hanger Twin Wheel 1/2" Offset

## E-Z ROLL REPLACEMENT HARDWARE FOR FOLDING BI-FOLD DOORS

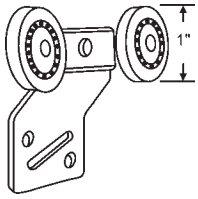

**900-1302**

H.D. Front Hanger Twin Wheel w/Ball Bearing Wheel, 3/16" Offset

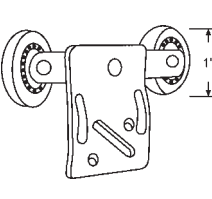

**900-1303**

H.D. Rear Hanger Twin Wheel w/Ball Bearing Wheel, 1/2" Offset

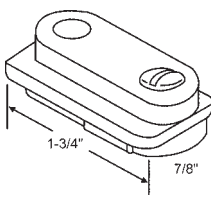

**7-251**

Top Bracket

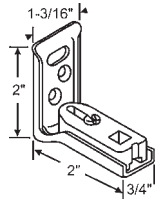

**7-250**

Bottom Bracket

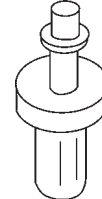

**900-1325**

Top Pivot Spring Loaded

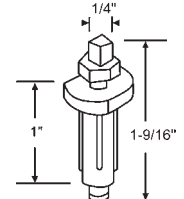

**2-114**

Bottom Pivot

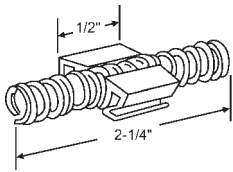

**8-491**

Snugger for 4 Doors

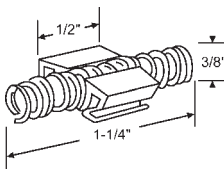

**8-213**

Snugger for 2 Doors

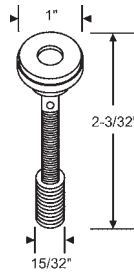

**2-112**

Top Rolling Guide 1" Round Nylon Wheel 2" Threaded Stem (For replacing older hardware)

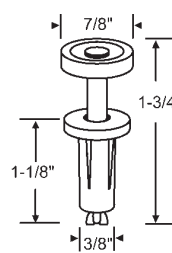

**2-104**

Top Rolling Guide Spring Loaded

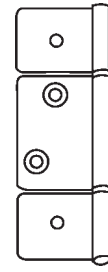

**8-356**

3 Wing Non Mortise Hinges

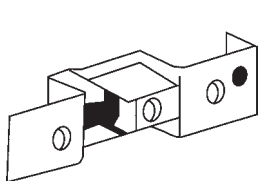

**900-16386**

Top Bracket

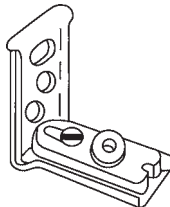

**900-16387**

Bottom Bracket

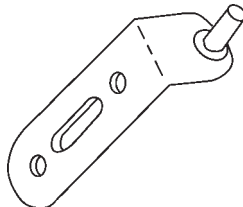

**900-16388**

Top Pivot

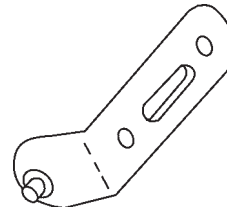

**900-16389**

Bottom Pivot

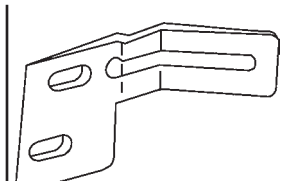

**8-490**

Door Aligner for 4 Doors

## E-Z ROLL UNIVERSAL FLOOR GUIDES

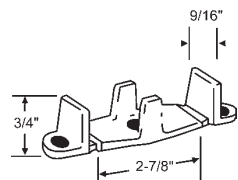

**8-240**

3 Piece. Floor Guide, Adjustable to Fit 3/4" or 1-3/8" Thick Doors

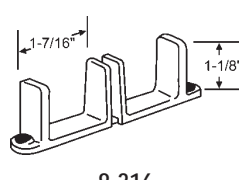

**8-316**

2 Piece. Floor Guide, Adjustable to Fit 1-3/8" Thick Doors, 1-1/4" High from Floor.

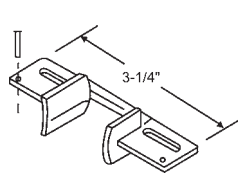

**8-313**

1 Piece. Nylon Guide for Single Pocket Door

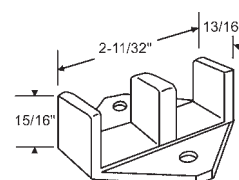

**8-314**

1 Piece. Floor Guide to Fit 3/4" Doors

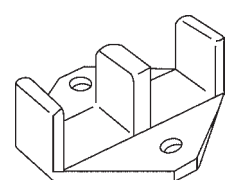

**8-288**

1 Piece. Floor Guide to Fit 1-1/8" Doors

# CLOSET DOOR HARDWARE

## E-Z ROLL UNIVERSAL FLOOR GUIDES

## E-Z ROLL UNIVERSAL DOOR FINGER PULLS

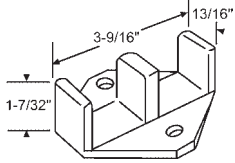

**8-291**

1 Piece. Floor Guide to Fit 1-3/8" Double Doors 1-1/4" High from Floor

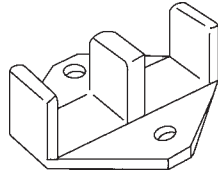

**8-421**

1 Piece. Floor Guide to Fit 1-3/4" Doors

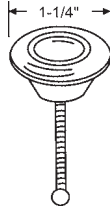

**8-489**

1-1/4" Nylon Plastic Pull Knob

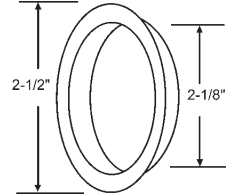
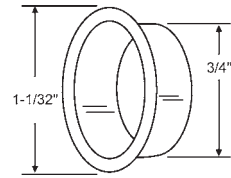

**8-202**

Brass Plated

Part #	Hand
900-616	Brass Plated
900-616SSN	Satin Nickel

## PANIFLEX CLOSET DOOR HARDWARE

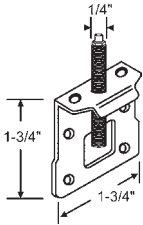

**2-69**

Bottom Pivot

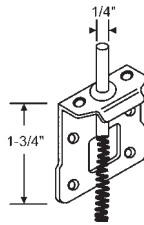

**2-68**

Top Pivot

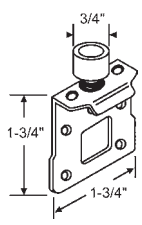

**2-67**

Roller Bracket

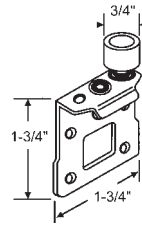

Part #	Hand
2-66	Shown
2-65	Opposite

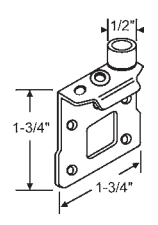

Part #	Hand
2-71	Shown
2-70	Opposite

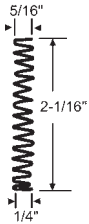

**5-54**

Top Pivot Spring

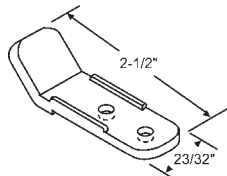

**900-847**

Door Aligner

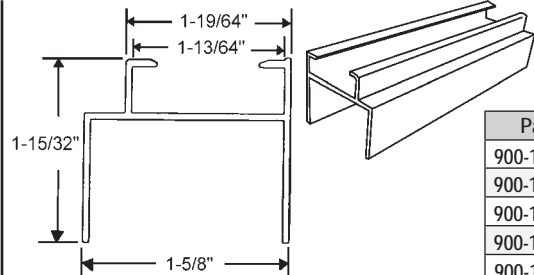

Part #	Size
900-16703-A	4 ft.
900-16703-B	6 ft.
900-16703-C	8 ft.
900-16703-D	10 ft.
900-16703-E	12 ft.

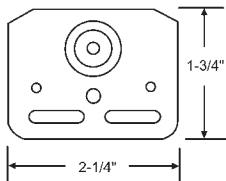

**7-201**

Metal Floor Plate

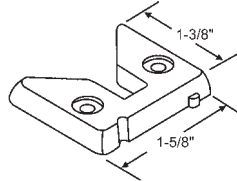

**900-849**

Nylon Floor Plate (Single)

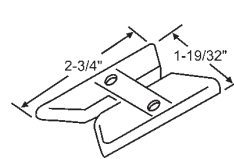

**900-848**

Nylon Floor Plate (Double)

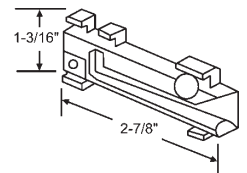

**7-235A**

Sold as Set (1 LH, 1 RH). Nylon

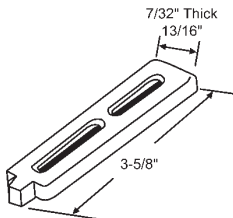

**8-295**

Guide System

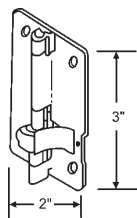

**8-230**

Cam Hinge

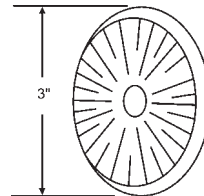

**8-332**

Brass Back Plate

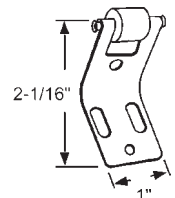

**900-851**

Pivot Aligner. 31/64" Dia. x 1/2" Width  
Nylon Roller

# CLOSET DOOR HARDWARE

## FLOATAWAY CLOSET DOOR HARDWARE

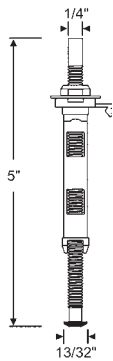

Assembly # 1-103	
Square Nut	6-157
Speed Nut	6-161
Pin Sleeve	900-6656

Pin Assembly with Plastic Sleeve

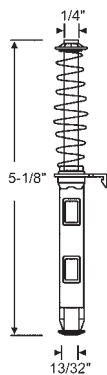

Assembly # 1-104	
Spring	5-59
Push Nut	6-122

Pin Assembly with Plastic Sleeve

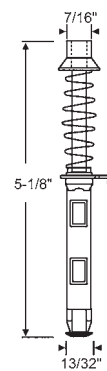

Assembly # 1-105	
Cap	4-106
Spring	5-59

Pin Assembly with Plastic Sleeve

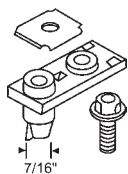

**7-223**  
Nylon

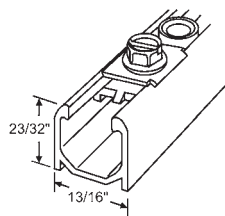

Part #	Size
8-350-3	3 ft.
8-350-4	4 ft.
8-350-6	6 ft.
8-350-8	8 ft.

Pivot Bracket Not Included

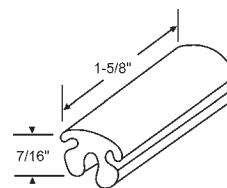

**8-304**  
White

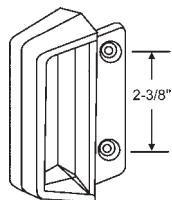

**8-344\***  
Chrome

\*Call for availability

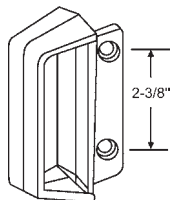

**8-305**  
White

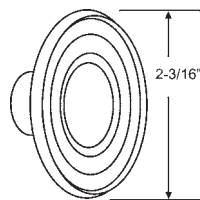

**8-349**  
Plastic Door Knob  
White

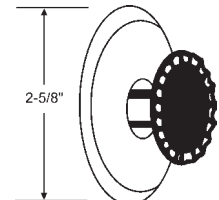

Part #	Finish
8-228B	Bronze
8-228A	Polished Aluminum

## SLIMFOLD CLOSET DOOR HARDWARE

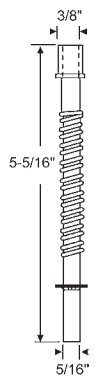

Assembly # 1-184	
Cap	4-103
Spring	5-50
Push Nut	6-111

Bi-fold Pin Assembly

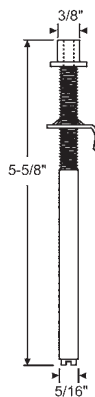

Assembly # 1-174	
Cap	4-117
Threaded Tinnerman	6-145

Bi-fold Bottom Pivot Rod Assembly

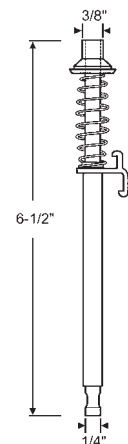

Assembly # 1-102	
Cap	4-120

Bi-fold Spring Loaded Guide Rod Assembly

# CLOSET DOOR HARDWARE

## SLIMFOLD CLOSET DOOR HARDWARE

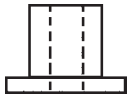

**4-117**  
Fits Pins 1-174, 1-197,  
1-232, 1-261

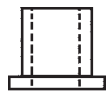

**4-103**  
Fits Pins 1-183, 1-184

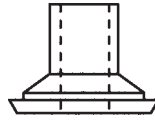

**4-120**  
Fits Pin 1-102

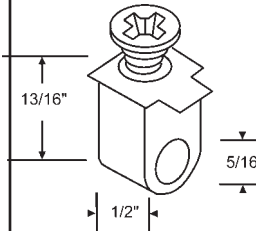

**7-231**  
Nylon  
New Style

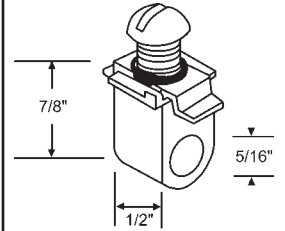

**7-231OS**  
Nylon  
Old Style

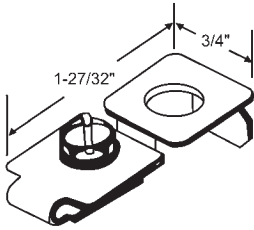

**7-200**  
Pivot Bracket  
Metal

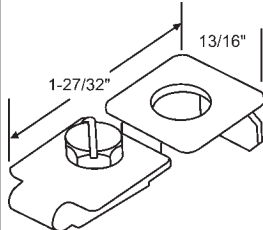

**7-272**  
Bi-fold Track Socket with Screw  
Metal

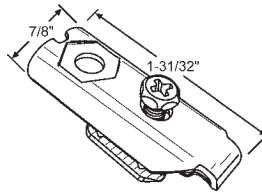

**7-273**  
Pivot Bracket

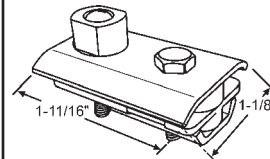

**7-256**  
Top Pivot Retainer. Includes One  
#10-32 x 3/4" Hex Screw.

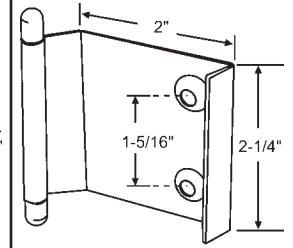

**8-278**  
Door Pull Set. Chrome

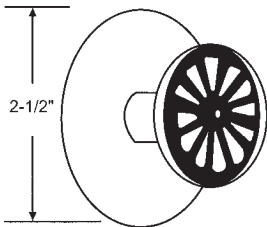

**8-258**  
Brass  
8-327 Knob, 8-321 Back Plate

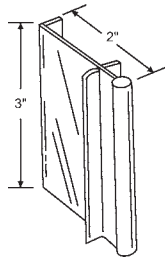

Part #	Finish
8-414	Bright Gold
8-414W	Bright White

Self-Adhesive

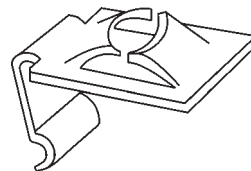

**6-145**  
Retainer Clip  
5/16" - 18 Threaded  
Used with 1-138A, 1-155, 1-174,

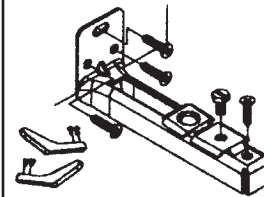

**7-277**  
Bottomless Track Bracket

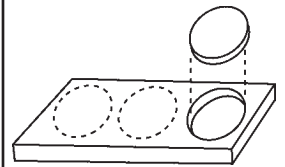

**900-7429**  
Bi-fold Plastic Silencer  
Clear - 3 Per Pad

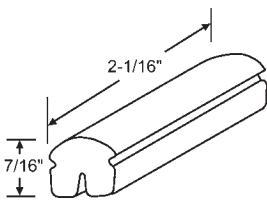

**8-279**  
Gray Bi-fold Track Bumper

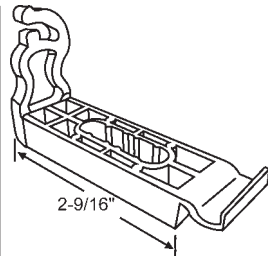

**8-409**  
Bypass Top Guide

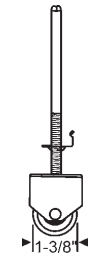

**900-12272N**  
New Style

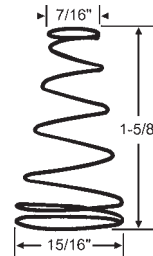

**5-62**  
Spring

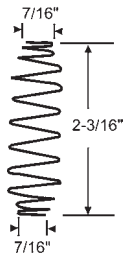

**5-69**  
Spring



**900-7431**  
#10 - 3/4" Pan Head Bottom  
Track Screws



**900-7430**  
#10 - 1-3/4" Pan Head Top  
Track Screws

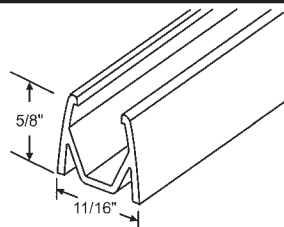

Part #	Size
900-8395	59-1/2"
900-8395-2	23-1/2"
900-8395-3	35-1/2"
900-8395-6	71-1/2"

Two-Panel Aluminum Track  
Mill

# SHOWER DOOR HARDWARE

## SHOWER DOOR ROLLERS

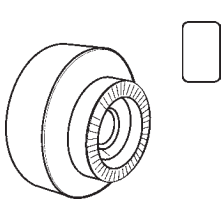

Part #	Dia.	Wide	Hub
900-18675	5/8"	1/4"	13/32"

Steel Hub, Hex End, Flat Plastic Wheel

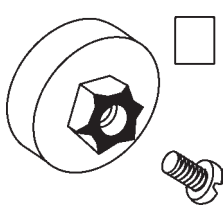

Part #	Dia.	Wide	Hub
21-50-2	3/4"	1/4"	3/8"

Nylon  
Pack of two with screws

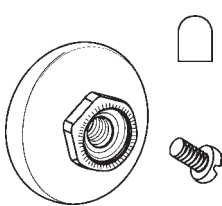

Part #	Dia.	Wide	Hub
21-51-2	3/4"	1/4"	3/8"

Nylon  
Pack of two with screws

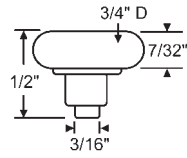

**1081P**

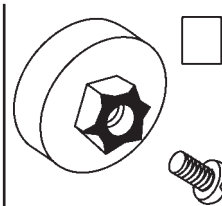

Part #	Dia.	Wide	Hub
21-66-2	7/8"	1/4"	3/8"

Nylon  
Pack of two with screws

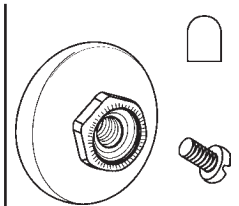

Part #	Dia.	Wide	Hub
21-52-2	7/8"	5/16"	3/8"

Nylon  
Pack of two with screws

## ROLLER ASSEMBLIES

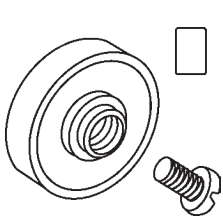

Part #	Dia.	Wide	Hub
21-53	1-1/16"	7/32"	9/32"

Nylon  
21-53S for Screw Only.

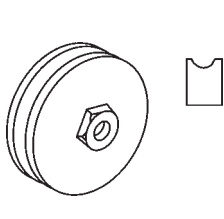

Part #	Dia.	Wide	Hub
21-69BR	1"	1/4"	3/8"

Celcon  
8-32 Thread

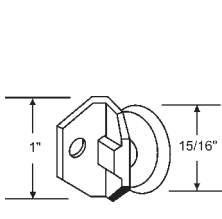

**21-63**  
Nylon  
**TUBMASTER**

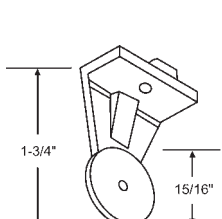

**21-64**  
Shower Door Roller with Bracket Nylon  
**TUBMASTER**

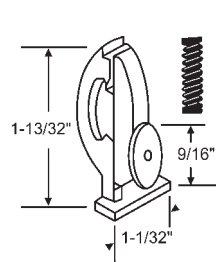

**21-60**  
Shower Roller. 1 Wheel Nylon

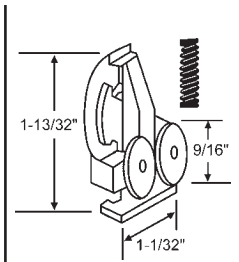

**21-59**  
Shower Door Roller Nylon

## ADJUSTING ROLLER ASSEMBLIES

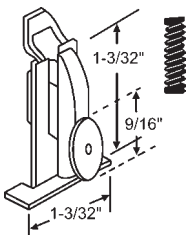

**21-62**  
Shower Door Roller Nylon w/Aluminum Bracket

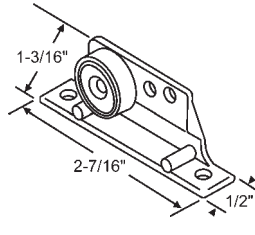

Part #	Roller	Handed
21-57	21-50	Shown
21-58	21-51	Opposite

No Longer Available  
Use: 21-57NS and 21-58NS

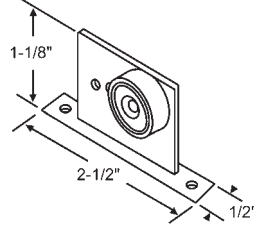

Part #	Roller
21-57NS	21-50
21-58NS	21-51

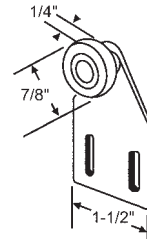

**21-54**  
Door Roller with Bracket

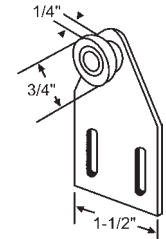

**21-56**  
Door Roller with Bracket Roller Only 21-50

## LATCH

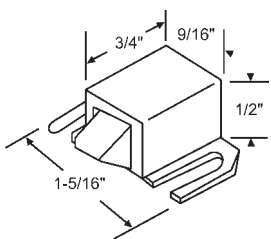

**22-54**  
Stainless Steel Housing

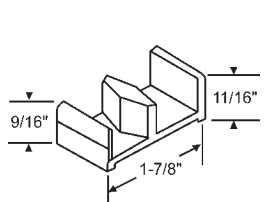

**22-50**  
Nylon

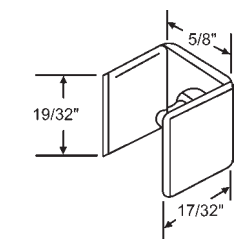

**22-51**  
Nylon

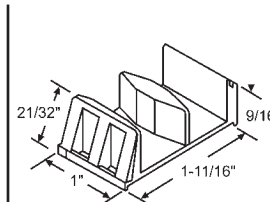

**900-6426**  
Open Track Guide

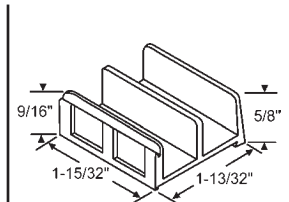

**900-17327**

## SHOWER DOOR GUIDES

# SHOWER DOOR HARDWARE

## SHOWER DOOR GUIDES

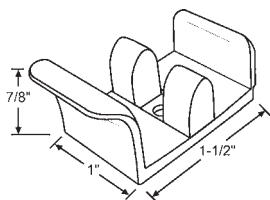

**22-113**  
White Nylon  
**KELLER**

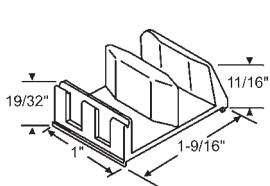

**900-17497**

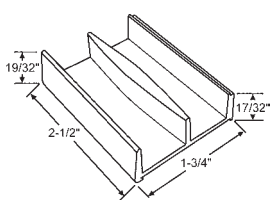

**22-141**  
White Nylon  
**PETERSON**

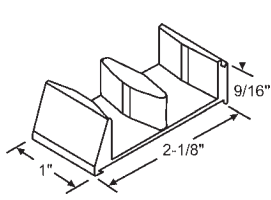

**900-10563**

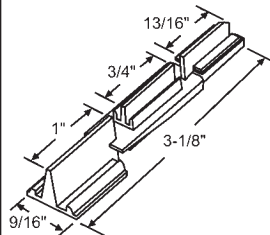

**22-203**  
Bottom Guide  
Nylon

### BUMPERS

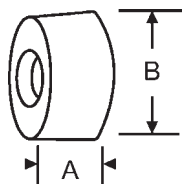

Part #	A	B	Finish
16-105	3/8"	15/16"	Gray
16-107	7/32"	3/4"	White
22-65	1/4"	3/4"	Clear

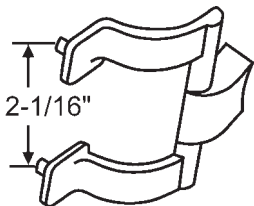

**22-83**  
Chrome Handle  
with Towel Bar Insert

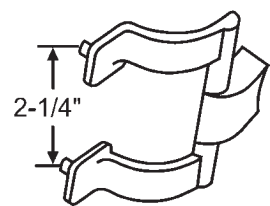

**900-10709**  
Chrome

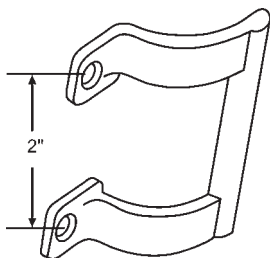

**22-67**  
Chrome  
No Longer Available.  
Use: 22-67PA

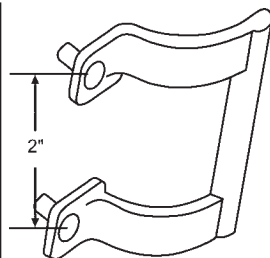

**22-67P**  
Chrome

### SHOWER DOOR HANDLES

### SHOWER DOOR ACCESSORIES

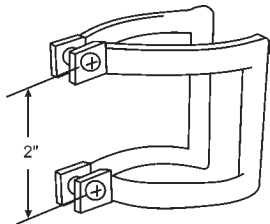

**22-67PA**  
Shower Door Handle Set  
Chrome Plated with Screws.  
Complete Bracket Assembly

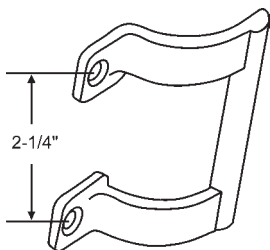

**900-9079**  
Chrome

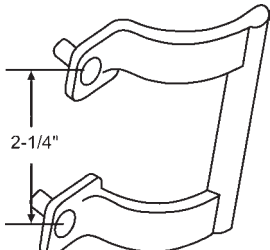

**900-10496**  
Chrome

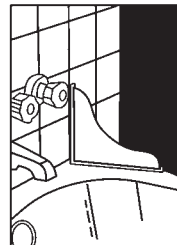

Part #	Length
22-114	7" x 7"
22-115	7" x 9"

Splash Guard. White. Self  
Adhesive Backing

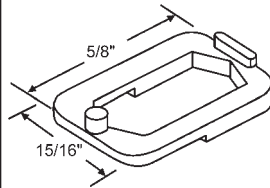

**900-6060**  
Adjusting Bracket

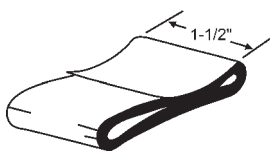

**22-52**  
Shower Door Seal  
Gray. 36" Long

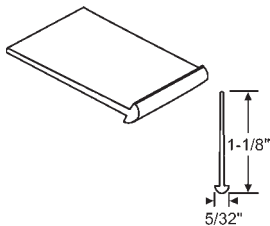

**22-103**  
1-1/8" Shower Door Sweep

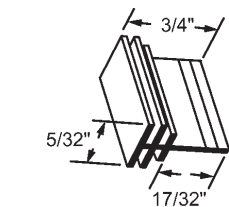

**900-15993**  
36" Shower Door Sweep  
Used on Hinged Shower Doors  
Gray Vinyl

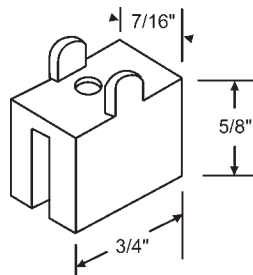

**22-60**  
Hinge Guide

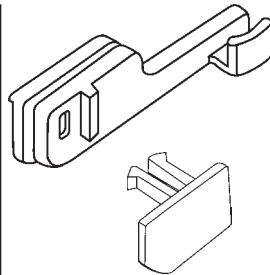

**22-71A**  
Slide Guide with Pin

# STORM DOOR HARDWARE

## KNOB/PUSH PULL LATCH SETS

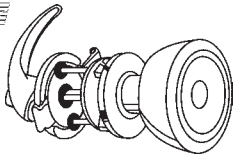

Tulip Knob Latch, Single Hole

Part #	Color
17-52	Aluminum

- Fits doors 1" - 1-1/4" thick.
- Resilient strike
- Installs in single hole bore 1-1/4" diameter.

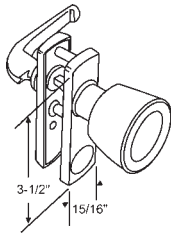

Tulip Knob Latch

Part #	Color
17-59	Black
17-60	Aluminum

- Resilient strike
- 1-3/4" installation hole spacing
- Fits doors 1" - 1-1/4" thick.

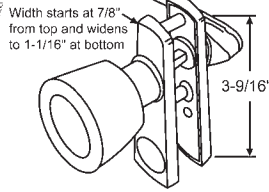

Tulip Knob Latch "No Lock Out" Feature

Part #	Color
17-61	Aluminum

- Solid strike
- 1-3/4" installation hole spacing
- "No Lock Out" feature prevents accidental lock out.
- Fits doors 7/8" - 1-1/4" thick.

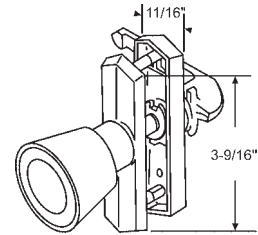

Tulip Knob Latch

Part #	Color
17-50	Aluminum
17-51	Black

- Resilient strike
- 3" installation hole spacing
- Fits doors 1" - 1-1/4" thick.

## PUSH BUTTON LATCH SET

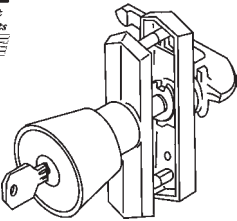

Tulip Key-In-Knob Lock (3")

Part #	Color
900-7320	Aluminum

- Resilient strike
- 3" installation hole spacing
- Key lock for extra security
- Fits doors 7/8" - 1-3/8" thick.

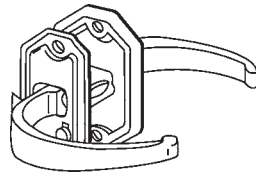

Push Pull Latch

Part #	Color
17-67	Aluminum

- Popular for wood door applications.
- Resilient strike
- Installs in 1" diameter single hole bore.
- Fits Doors 1" - 1-1/4" Thick.

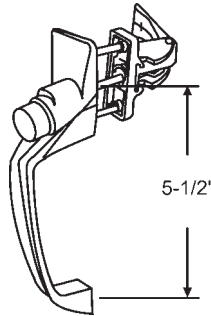

Part #	Color
17-65	Aluminum
17-66	Black

- Resilient strike
- 1-1/2" mounting hole spacing
- Fits doors 1" - 1-1/4" thick.
- Tie down type

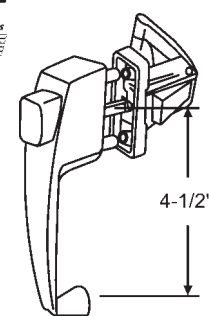

Part #	Color
17-58B	Black
17-58W	White

- Resilient strike
- 1-3/4" installation hole spacing
- Fits doors 1" - 1-1/4" thick.
- Tie down type

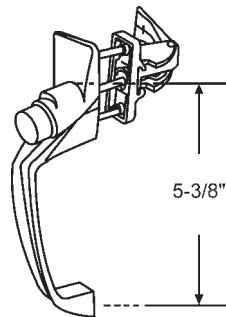

Part #	Color
17-82A	Aluminum
17-82	Black
17-82W	White

- Resilient strike
- 1-3/4" mounting hole spacing
- Fits doors 5/8" - 1-1/4" thick.
- Tie down type

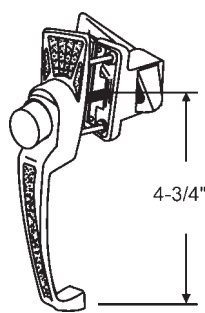

Part #	Color
17-73	Aluminum
17-72	Black

- Solid strike
- 1-3/4" installation hole spacing
- "No Lock Out" feature prevents accidental lock out.
- Fits doors 5/8" - 1-1/4" thick.

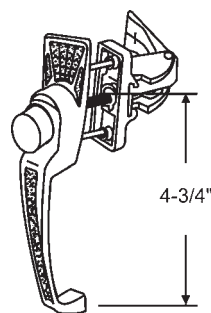

Part #	Color
17-53	Aluminum
17-54	Black

- Resilient strike
- 1-3/4" installation hole spacing
- Fits doors 1" - 1-1/4" thick.

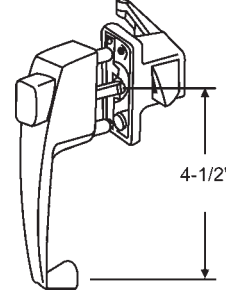

Part #	Color
900-7339	Aluminum
900-7339BL	Black
900-7339W	White

- Heavy Duty Push Button Latch
- Solid strike
  - 1-3/4" installation hole spacing
  - "No Lock Out" feature prevents accidental lock out.
  - Fits doors 1" - 1-1/4" thick.



## PUSH BUTTON LATCH SET

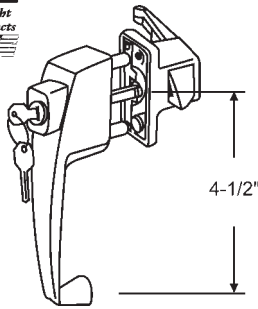

Part #	Color
900-7339KBL	Black

Heavy Duty Push Button Latch

- Solid strike
- 1-3/4" installation hole spacing
- "No Lock Out" feature prevents accidental lock out.
- Furnished with 2 Brass Keys
- Fits Doors 1" - 1-1/4" Thick.

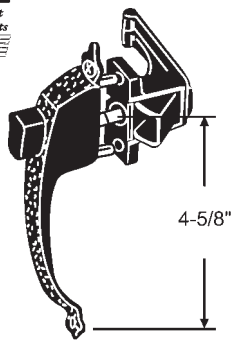

Part #	Color
900-14570	Black

Colonial Heavy Duty Push Button Latch

- Solid strike
- 1-3/4" installation hole spacing
- "No Lock Out" feature prevents accidental lock out.
- Fits Doors 1" - 1-1/4" Thick.

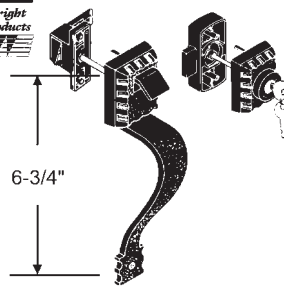

Push Button Set with Deadbolt

Part #	Color
900-13554K	Black

Deadbolt Only

Part #	Color
900-13554DB	Black

- Mounting hole center 1-3/4"
- Fits doors 1" - 1-1/4" Thick.

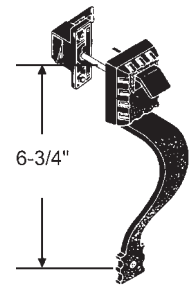

Push Button Set Only

Part #	Color
900-13554	Black

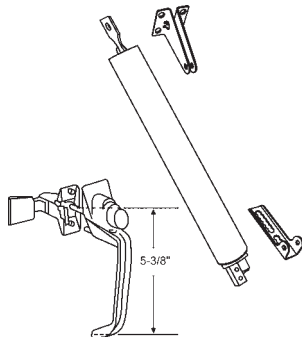

Part #	Color
19-709B	Black
19-709AL	Aluminum

Storm Door Hardware Kit.  
Does Not Include Chain

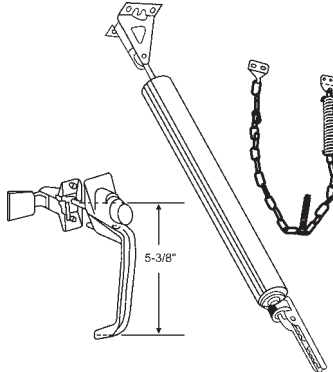

Part #	Color
19-199B	Black

Storm Door Hardware Kit with Chain  
Steel Tube

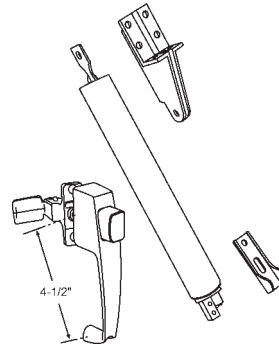

Part #	Color
19-376W	White
19-376BR	Bronze

Corrosion Resistant. Ideal for Coastal Applications.  
Includes Pneumatic Door Closer, Heavy Duty Plastic Jamb Bracket, Push-Button Latch with 1-3/4" Installation Hole Spacing, Screws, and Instructions

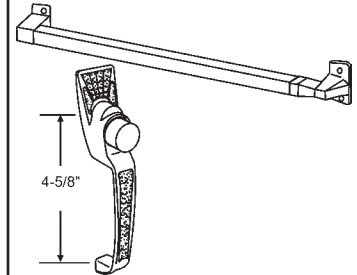

Touchbar™ Latch Set

Part #	Color
17-63-2	Aluminum
17-63-1	Black
17-63-3	White

- For all outswinging doors up to 36" wide.
- Protects against glass and screen damage
- "No Lock Out" latch, solid strike

**IDEAL**

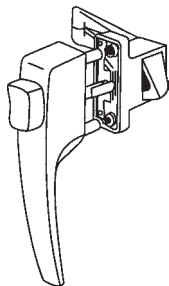

Push Button Latch - No Key

Part #	Color
17-70	Aluminum
17-70W	White
17-71	Black

- Solid strike
- 1-3/4" installation hole spacing
- "No Lock Out" feature prevents accidental lock out.
- Fits doors 5/8" - 1-1/4" thick.

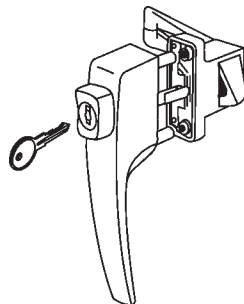

Push Button Latch with Key

Part #	Color
17-70K	Aluminum
17-71K	Black

- Solid strike
- 1-3/4" installation hole spacing
- "No Lock Out" feature prevents accidental lock out.
- Fits doors 5/8" - 1-1/4" thick.

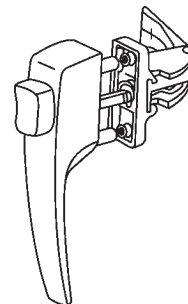

Push Button Latch

Part #	Color
17-56	Black
17-55	Aluminum

- Resilient strike
- 1-3/4" installation hole spacing
- Fits doors 1" - 1-1/4" thick.

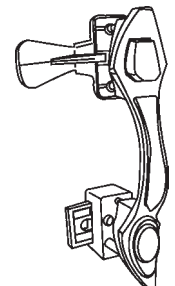

Quincy Push Button Latch Set

Part #	Color
17-127	Brass Finish
17-127AB	Antique Brass

- Elegant Styled Handle with Interior Deadbolt
- "No Lock Out" Feature
- 1-3/4" Hole Spacing
- Installs in six 5/16" Diameter Holes
- Handle: 8"
- Reversible

# STORM DOOR HARDWARE

## VP PULL HANDLE SET

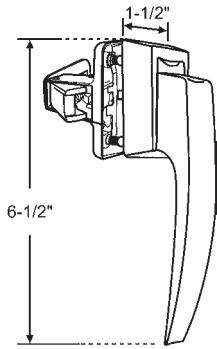

Part #	Color
17-191-1	Black
17-191-3	White

1-3/4" Hole Spacing. Operates with a single natural smooth action.

**IDEAL**

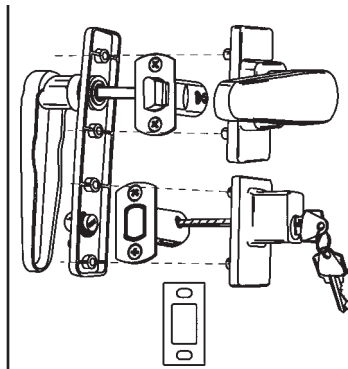

Part #	Interior	Exterior
17-128SCH	Satin Chrome	Satin Chrome

Storm Door Lever Set w/ Key & Deadbolt  
**TEMO**

## LEVER LATCH SETS

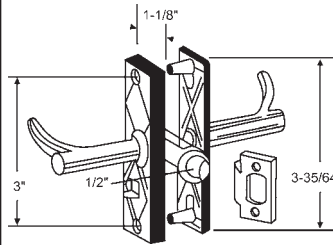

Storm & Screen Latch without Key

Part #	Color
900-14851	Aluminum

- Designed to Fit Most Combination Screen and Storm Doors
- Reversible • Slide Lock for Extra Security
- Accepts 7/8" to 1-1/4" Door Thickness
- 3/4" Backset
- Mounting Hole Center 3"

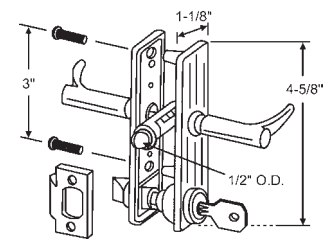

Storm & Screen Latch with Key

Part #	Color
900-14851K	Aluminum

- Designed to Fit Most Combination Screen and Storm Doors
- Reversible • Slide Lock for Extra Security
- Accepts 7/8" to 1-1/4" Door Thickness
- 3/4" Backset
- Mounting Hole Center 3"

Beautifully Designed, Classically Styled Lever Handle with an Elegantly Sculptured Escutcheon



Lever Latch Set with Keyed Deadbolt

Part #	Color
17-25BK	Black
17-25WK	White
17-25BR SK	Brass



Lever Latch Only

Part #	Color
17-25B	Black
17-25W	White
17-25BRS	Brass

- Positive Key Locking Deadbolt for Security • Strong Leveling Return Spring Eliminates Lever Droop • Fits Doors 1" to 2-1/4" Thick
- 1-3/4" Hole Spacing - Upper and Lower Trims • Install in 5/16" Diameter Holes • For Doors with a Stile Greater Than 2" • Escutcheon Width 1-5/8"
- Escutcheon Length: Upper 2-3/4", Lower 4-7/16" • Lever Projection 2-1/8" (From Door) • Backset - Variable with Several Strike Options Included
- Lever Length from Center of Hub: 4" • Non-Handed, Designed to Complement Both Right and Left Hand Doors • Escutcheon Plate Included for Use with Inside Latch.

## TRAILER LATCH SETS

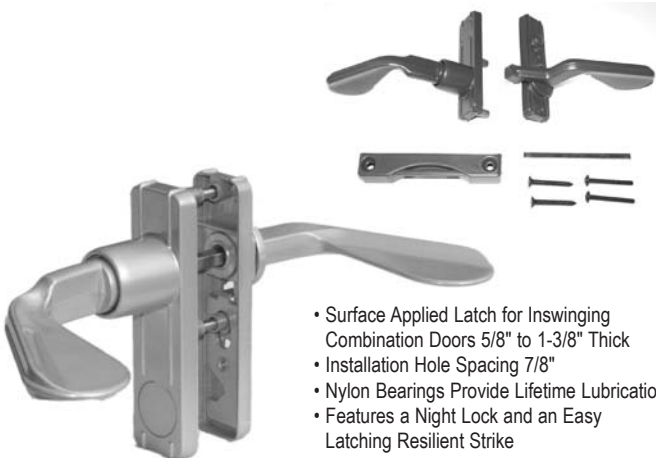

Inswinging Door Latch Set

Part #	Color
900-7323	Aluminum
900-7323B	Black
900-7323W	White

- Surface Applied Latch for Inswinging Combination Doors 5/8" to 1-3/8" Thick
- Installation Hole Spacing 7/8"
- Nylon Bearings Provide Lifetime Lubrication
- Features a Night Lock and an Easy Latching Resilient Strike
- Reversible for Right and Left Hand Doors and Fits Stiles as Narrow as 1-3/8"
- Installs in Three 1/4" Holes
- Inside Lever Projection is 3"
- Outside Lever Projection is 3-3/4"
- Mounts 1-3/4" Center to Center

**IDEAL**

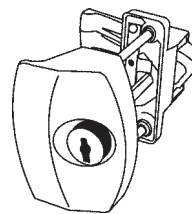

Part #	Color
17-21KA	Aluminum

Low Profile Trailer Lock Set with Key (Entrance)

- For Outswinging Wood or Metal Doors
- Fits 3/4" to 1-1/4" Doors
- Installation Hole Spacing 1-3/4"
- Installs in Two 5/16" Holes and One 7/8" Hole
- Use Wherever a Keyed Locking Unit is Required
- "No Lock Out" Feature

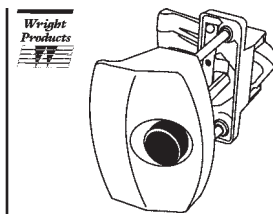

Wright Products

Part #	Color
17-21B	Black

Low Profile Trailer Lock Set with Push Button (Privacy)

- For Outswinging Wood or Metal Doors
- Fits 1/2" to 1-1/4" Doors
- Installation Hole Spacing 1-3/4"
- Installs in Three 5/16" Holes
- Emergency Entrance can be Made from the Outside by Using a Coin or Screwdriver
- "No Lock Out" Feature

## CLOSERS

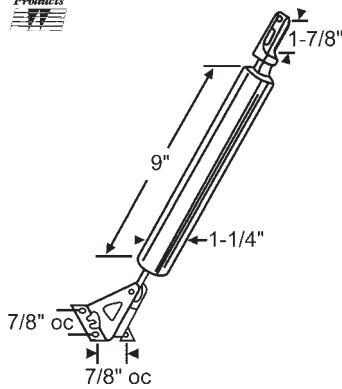

Part #	Color
18-52	Aluminum
18-53	Black
18-52W	White

### Pneumatic Door Closer

- For Light Weight Screen Doors
- For Wood or Metal Doors
- For Outswinging Doors
- Full 90° Opening
- Adjustable Closing Speed
- Factory Lubricated

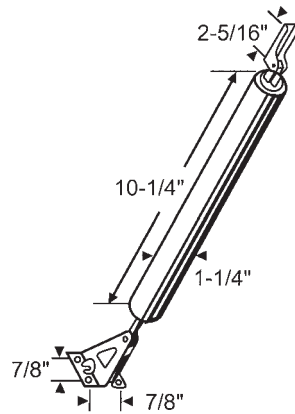

Part #	Color
18-63	Aluminum
18-62	Black
18-62W	White

### Economy Air Closer

- For Doors up to 1-1/4" Thick
- Adjustable Closing Power

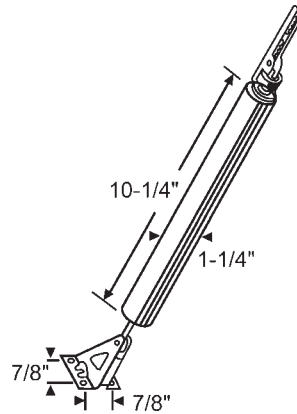

Part #	Color
18-65	Aluminum
18-64	Black
18-64W	White

### Silent Action Door Closer

- For Doors up to 1-1/4" Thick
- Permanently Lubricated
- Adjustable Latching Power
- Adapter Plates to Cover Old Holes

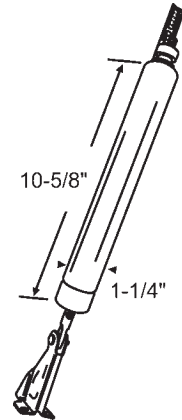

Part #	Color
18-71	Aluminum
18-71B	Black

### Pneumatic Door Closer

- For Doors up to 1-1/4" Thick
- Temperature Changes Do Not Affect Closing Action
- Permanently Lubricated
- Automatic Hold Open/Easy Close Feature

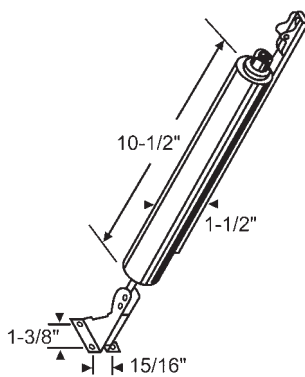

Part #	Color
18-58	Aluminum
18-57	Black

### "Smooth Air" Heavy Duty Door Closer

- For Storm and Screen, Jalousie or Interior Doors up to 1-3/4" Thick
- Has Two Times the Power of Standard Closers at Latching Position
- Permanently Lubricated
- Adjustable Speed Control

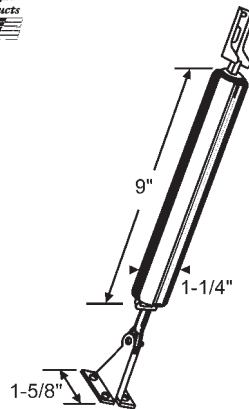

Part #	Color
18-103	Aluminum
18-102	Black
18-102W	White

### 820 Pneumatic Door Closer

- For Light Storm Doors of Wood or Metal
- Full 90° Opening
- Two-Hole End Plug for Summer and Winter Adjustment
- Adjustable Closing Speed
- Total Length when Mounted Per Instructions: 11-1/16"

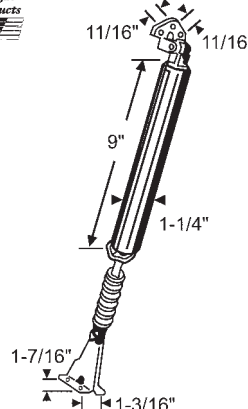

Part #	Color
18-61	Aluminum
18-60	Black
18-60W	White

### Pneumatic Door Closer

- For Wood or Metal Doors
- Full 90° Opening
- Two-Hole End Plug for Summer and Winter Adjustment
- Adjustable Closing Speed
- External Spring to Prevent Rod Bending
- Packaged with Narrow and Wide Bracket
- Total Length when Mounted Per Instructions: 13-7/16"

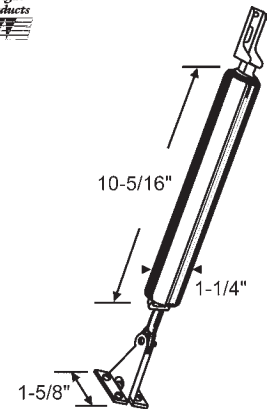

Part #	Color
18-114	Aluminum
18-112	Black
18-113	White

### 920 Pneumatic Door Closer

- For Wood or Metal Doors
- Full 90° Opening
- Two-Hole End Plug for Summer and Winter Adjustable Latching Power
- Adjustable Closing Speed
- Total Length when Mounted Per Instructions: 12-11/16"

# STORM DOOR HARDWARE

## CLOSERS

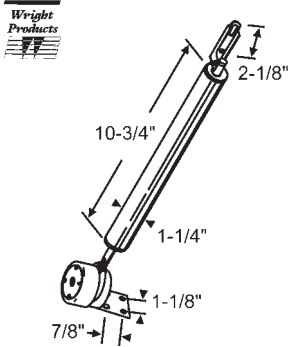

Part #	Color
18-50	Aluminum
18-50B	Black

### Deluxe Heavy Duty Door Closer

- Designed for Heavy Combination Storm and Screen Doors, Light Exterior Doors and Interior Doors
- For Right or Left Hand Inswinging or Outswinging Doors.
- Manual Hold Open Feature
- Available in Black and Aluminum
- Packed with Installation Instructions (Instructions also available online)

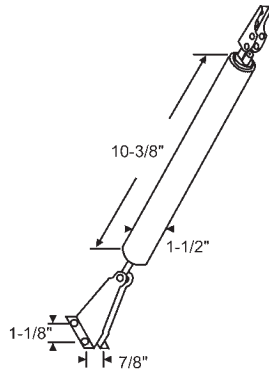

Part #	Color
18-97	Aluminum
18-97B	Black
18-97W	White
18-97G	Gold

### 150 Heavy Duty Torsion Pneumatic Door Closer

- For Wood or Metal Doors
- Full 90° Opening
- Two-Hole End Plug for Summer and Winter Adjustment
- Adjustable Closing Speed
- Internal Bumper for Prevention of Rod Bending
- Total Length when Mounted Per Instructions: 12-3/4"

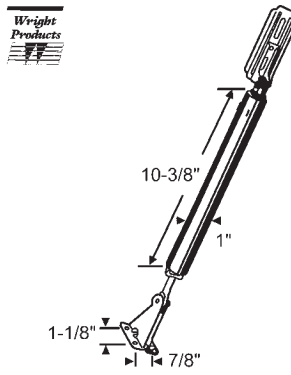

Part #	Color
18-55	Aluminum
18-56	Black

### H440 Hydraulic Door Closer

- Hydraulic Mechanism Provides Smooth "No Bounce" Action
- For Wood or Metal Doors
- Full 90° Opening
- Two-Hole End Plug for Summer and Winter Adjustment
- Adjustable Closing Speed by Rotating the Tube
- Aluminum Tube Assembly
- Total Length when Mounted Per Instructions: 12-11/16"



Part #	Color
18-143	Black

### Standard Pneumatic Door Closer

- Internal spring for shock absorption
- Provides 90° opening for outswinging doors
- Adjustable closing speed control valve
- Permanent internal lubrication
- All necessary hardware included

## INSIDE LATCHES

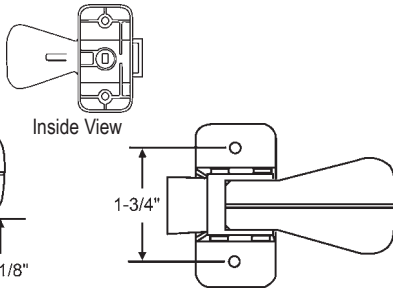
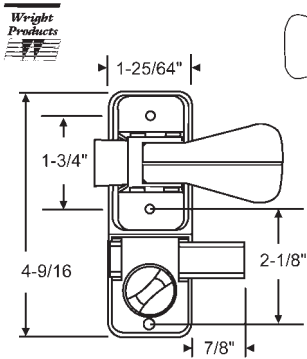

Part #	Color
17-140	Black

### Inside Latch and Deadbolt

Part #	Color
17-135	Black

### Deadlock Only

Part #	Color
17-160	Black

- Durable, Heavy-Duty Design
- 1-3/4" Installation Hole Spacing
- Installs in Three 5/16" Holes
- Spring Loaded Nose for use with Z-Bar or Solid Strike
- Latch Assembly and Deadbolt are Reversible
- Can Replace Lever, Knob or Push Button Latch Designs

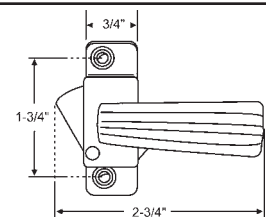

Part #	Color
17-1	Black
17-2	Aluminum

- For all Outswinging Doors 5/8" to 1-1/4" thick
- "No Lock Out" Feature
- 1-3/4" Mounting Hole Spacing
- Installs in Three 5/16" Holes
- Has a Spring Loaded Nose so a Solid Strike is Required

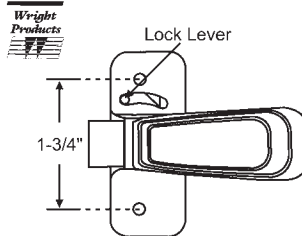

- Installs in Three 5/16" Holes
- Has a Spring Loaded Nose so Z-Bar or Solid Strike is Required
- "No Lock Out" Feature

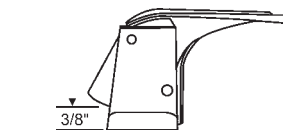

Part #	Color
17-174	Black

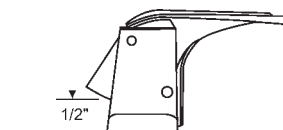

Part #	Color
17-18	Black

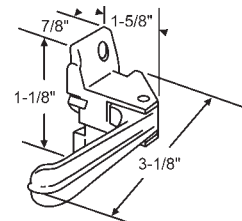

Part #	Color
17-3	Black

1-3/4" Mounting Hole Spacing Standard Latch

## KEY LOCKS

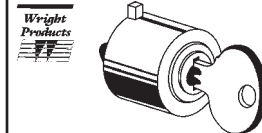

Part #	Color	Converts Handles
19-125	Black	17-65, 17-66

Converts Latches to Key Locking Sets

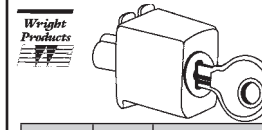

Part #	Color	Converts Handles
19-127	Black	17-56, 17-71, 17-96, 900-7339B, 900-7340

Converts Latches to Key Locking Sets

## PANEL CLIPS AND THUMB SCREWS

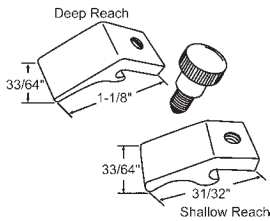

Part #	Color
19-465	White
19-465B	Black

Storm/Screen Door Panel Clip Kits . Includes 4 Each, 2 Styles (Deep and Shallow Reach) of Nylon Clips and 4 Aluminum Screws 8/32" x 1/4" (12pcs. Total)

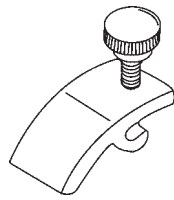

Part #	Color
19-122	Aluminum
19-112	White

1/4" Offset. Metal

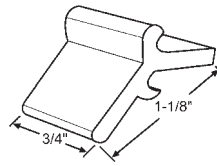

Part #	Color
19-129	White

Nylon

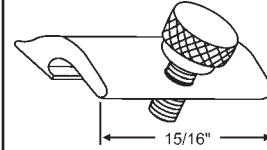

Part #	Color
900-8004BK	Black

Metal

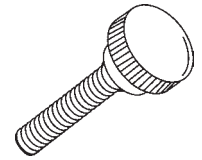

Part #	Color
19-116	Aluminum
19-123	White
19-123B	Brown

8-32 x 9/16". Aluminum

## STRIKES

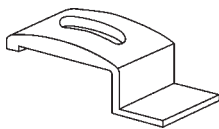

Part #	Color
19-100	Aluminum
19-108	White
19-109	Brown
19-109BZ	Bronze

1/4" Offset. Metal

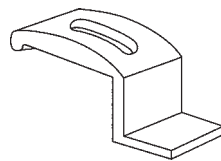

Part #	Color
19-102	Aluminum
19-110	White

3/8" Offset. Metal

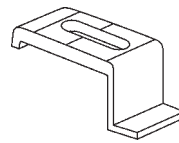

**900-14558**  
Storm Door Clip. White

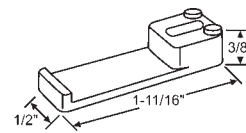

**900-6759**  
Storm Door Clip. White

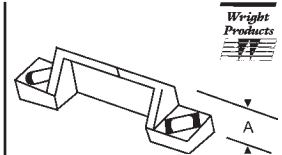

Part #	Color	A
19-185A	Silver	1/4"
19-185B	Black	1/4"
19-197	Steel	1/2"
19-197B	Black	1/2"

No Lock Out. Zinc Solid

## SHIMS

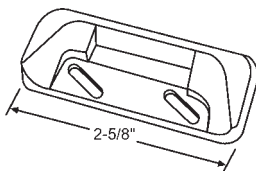

**19-227**  
Black Nylon

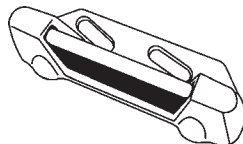

Part #	Color
19-194A	Silver
19-194B	Black

3/4" High Profile. Resilient  
**WRIGHT PRODUCTS**

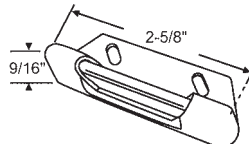

Part #	Color
19-300B	Black
19-300AL	Silver
19-300W	White

9/16" High Profile. Resilient  
**WRIGHT PRODUCTS**

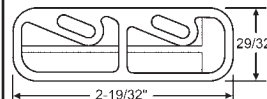

**19-196**  
1/16" Shim (plastic)  
Gray



**19-186G**  
1/8" Shim (plastic)  
Gray

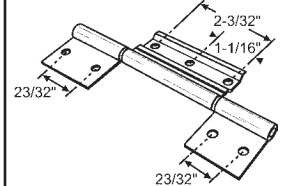

Part #	Color
19-708	Aluminum
19-708BZ	Bronze
19-708W	White

Offset Screen Door Hinge

## PUSH BUTTON



**19-128**  
Metal Breakaway Spindle  
with Spring

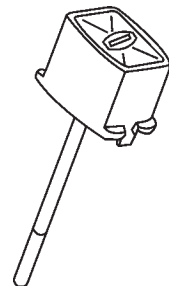

**19-131**  
Black Plastic. Used with  
17-56 & 17-58

## DOOR CHAIN



**19-106**  
Includes Hold-Up Spring to  
Prevent Chain from Hitting Door  
and Scratching Glass.  
Includes All Necessary Hardware

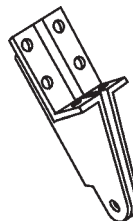

Part #	Color
19-332W	White
19-332B	Black
19-332FBN	Florida Brown

Florida Jamb Bracket. Plastic.

## SCREEN SPLINE

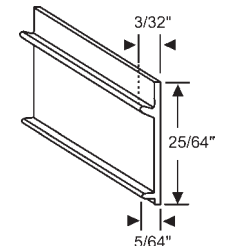

**66-61X**  
Vinyl Screen Spline. Black,  
100' Roll  
**FOREVER DOOR**

# GENERAL DOOR & BUILDERS HARDWARE

## ENTRANCE DOOR CLOSERS

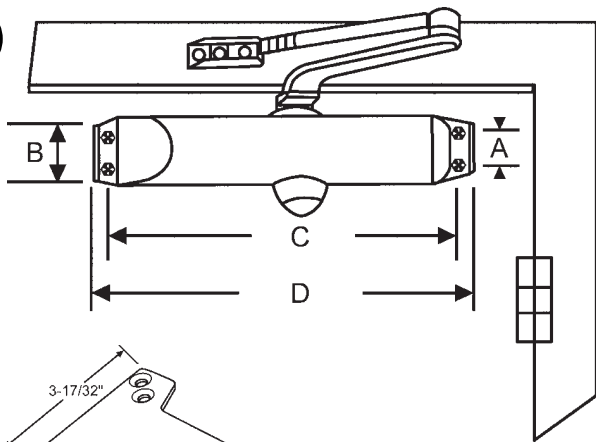

19-210  
Parallel Bracket

### FEATURES

- Surface mounted interior and exterior
- Size 3 is used on 3 ft. wide interior door or 2-1/2 ft. wide exterior door.
- Size 4 is used on 4 ft. wide interior door or 3 ft. wide exterior door.
- Non-handed
- Permanent lubricating hydraulic fluid
- Easy, smooth action
- Housing made of non-corroding aluminum.
- Narrow design is perfect for aluminum, glass, wood and other modern doors.

Part #	Size	A	B	C	D	Finish
18-70	#3	3/4"	1-3/4"	8-3/16"	8-15/16"	Aluminum (Silver)
18-72	#3	3/4"	1-3/4"	8-3/16"	8-15/16"	Bronze (Gold)
18-74	#3	3/4"	1-3/4"	8-3/16"	8-15/16"	Duranodic (Dk. Brown)
18-68	#4	3/4"	1-3/4"	9-1/16"	9-13/16"	Aluminum (Silver)
18-69	#4	3/4"	1-3/4"	9-1/16"	9-13/16"	Bronze (Gold)
18-73	#4	3/4"	1-3/4"	9-1/16"	9-13/16"	Duranodic (Dk. Brown)

### Dimensions for Closers with Backcheck Feature

Part #	Size	A	B	C	D	Finish
18-70BC	#3	3/4"	1-3/4"	8-3/16"	8-15/16"	Aluminum (Silver)
18-68BC	#4	3/4"	1-3/4"	9-1/16"	9-13/16"	Aluminum (Silver)

## POWER ADJUSTABLE CLOSER WITH BACK CHECK OR DELAYED ACTION

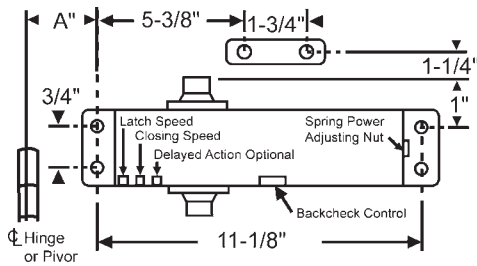
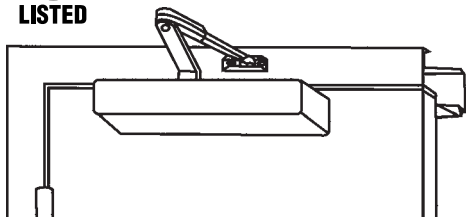

Opening	Dim. "A"
To 120°	7-3/32"
120° - 180°	3-15/16"

Part #	Finish
18-88	Aluminum (Silver)

**ANSI GRADE 1  
A - 156.4 STANDARDS  
APPLICABLE**

## DOOR STOPS AND BUMPERS

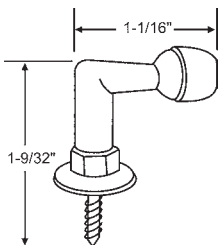

Part #	Finish
900-12356	Brass

Floor Type Door Stop

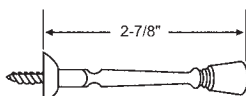

Part #	Finish
19-144	Brass

Solid Stop Bumper Assembly

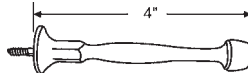

Part #	Finish
19-157	Brass
19-157DC	Dull Chrome

Solid Stop Bumper Assembly

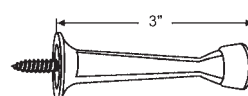

Part #	Finish
19-284SN	Satin Nickel

Solid Type

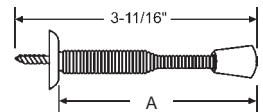

Part #	Finish	A
19-143	Brass	3"
19-143SN	Satin Nickel	3"
19-143CH	Chrome	3"
19-143-4	Brass	4"

Door Stop Bumper Assembly

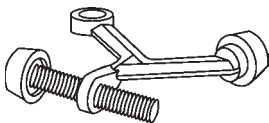

Part #	Finish
19-142	Brass
19-142A	Aluminum
19-142CH	Chrome
19-142W	White
19-142SN	Satin Nickel

Hinge Pin Door Stop

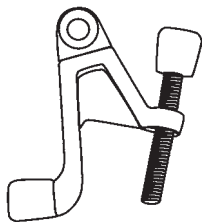

Part #	Finish
19-359	Bright Brass

Hinge Pin Door Stop

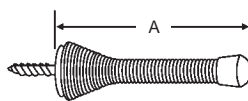

Part #	Finish	A
19-204	Brass	3"
19-204C	Chrome	3"
19-360CH	Chrome	3-3/4"

Heavy Duty Door Stop Bumper Flexible

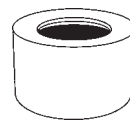

Part #	Color
19-145	White

Hinge Pin Door Stop Bumper Only. Fits 19-142, 19-142A, 19-142CH, 19-142W



Part #	Color
19-146	White

Door Stop Bumper Only. For 9/32" OD Door Stop

# GENERAL DOOR & BUILDERS HARDWARE

## DOOR STOPS AND BUMPERS

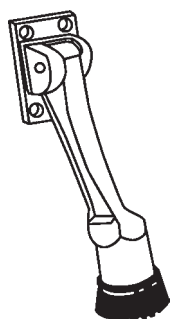

Part #	Finish
19-133	Brass
19-132	Aluminum

4" Drop Down Door Stop

Part #	Finish
19-136	Brass
19-137	Aluminum

5" Drop Down Door Stop  
Solid Cast Brass

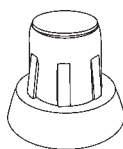

Part #	Color
19-187	Black

Rubber Tip Replacement Only.  
For Drop Down Door Stops. Fits  
19-132, 19-133, 19-136, 19-137

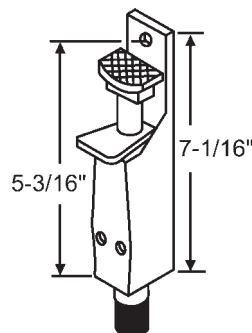

Part #	Finish
19-135	Brass
19-138	Aluminum
19-135PB	Bright Brass

### 19-135T

Screw type tip only.  
Black

## DOOR SILENCER

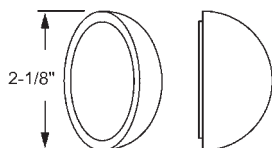

Part #	Color
19-242	White

Adhesive PVC Wall Bumper

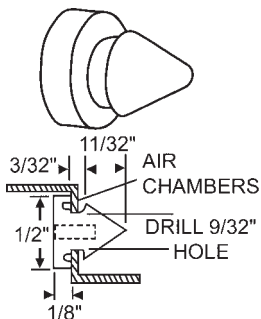

Part #	Color
19-134	Gray

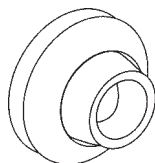

Part #	Finish
19-140	Stainless Brushed
19-140BZ	Dark Bronze
19-140AB	Antique Brass
19-140B	Brass

Screw mount, 2-1/2" diameter  
with gray vinyl bumper, concealed  
screw mount. Concave face to fit  
interior lock button. Furnished with  
anchor and screw.

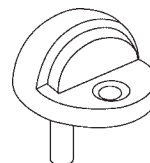

Part #	Finish
19-141	Brushed Satin

Zinc Die Cast, Low Profile  
Door Stop. 1-3/4" Base, 1"  
Height, 1/8" Clearance.

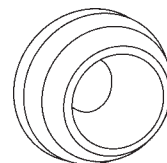

Part #	Color
19-139W	White
19-139	Gray

Adhesive backed, 1-7/8"  
diameter, gray rubber, peel-off  
label, pressure sensitive backed.

## WALL PROTECTORS

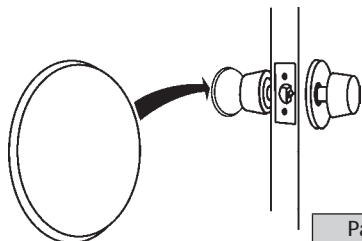

3" Diameter

Part #	Color
19-181	White
19-181OW	Off White

5" Diameter

Part #	Color
19-182	White

Made of high impact material  
that can be painted or papered.  
Use to repair larger areas of  
wall damage. Foam adhesive  
on back absorbs shock. 1/4"  
Total thickness. Washable.

## DOOR LOCK CHANNELS

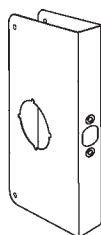

Part Number	Backset	Door Thickness
19-160-4	2-3/8"	1-3/8"

2-1/8" Bores. Large Single Hole.  
Brass Plated Aluminum.  
Overall Dimension 4" x 9"

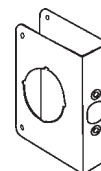

Part Number	Backset	Door Thickness
19-174-4	2-3/8"	1-3/8"

2-1/8" Bores. Small Single Hole.  
Brass Plated Aluminum.  
Overall Dimension 4" x 4-1/2"

## DOOR KNOCKER

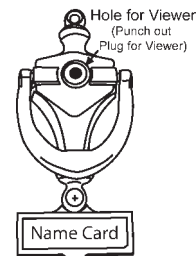

### 900-12213

Polished Brass. Name plate card.  
Cast knocker with polished brass  
finish. Surface mount application  
Space for door viewer.  
Viewer sold separately

## CHAIN LOCK

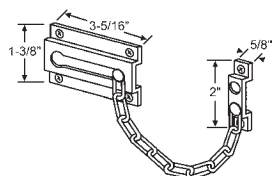

### 900-7490

Heavy Duty Brass Plated  
Steel Door Chain with Solid  
Brass Keeper



### 900-8108

Brass Plated Stamped Steel  
Door Chain

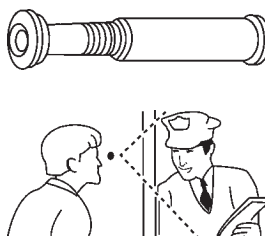

### 19-149

160° Angle Plastic Lens  
1/2" Installation Hole. Fits doors  
1-1/8" to 2-1/4" thick. Solid Brass

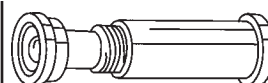

### 900-12562

160° angle plastic lens  
fits doors 1-3/8" to 2-1/4" thick  
1/2" installation hole, wide angle.  
See who is on the other side  
before you open the door.  
Solid brass construction

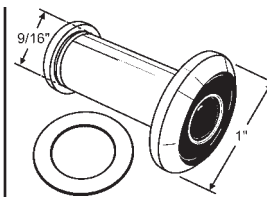

Part #	Color	Angle
19-215	Polished Brass	180°
19-215CP	Bright Chrome	180°
19-184	Polished Brass	200°

Solid Brass. 9/16" Bore, Fits  
1-3/8" to 2-1/4" Thick Doors

# CABINET HARDWARE

## DRAWER TRACK SETS

**45-23**  
Track Mounting Bracket

**45-14**  
Guide

**45-52**  
Corner Guide

Part #	Description
45-87	22-3/4" Track Set

Single Drawer Set  
(Track not available separately.)

**900-11843**  
Track Mounting Bracket  
Metal

**900-17778**  
Roller Bracket

**900-11808LH**  
Roller

**900-11808RH**  
Roller

Part #	Description
45-103	22-7/16" Complete Track Set Galvanized

## DRAWER INSERTS

Part#	"A"	"C"	# Stamped on part	Carton Qty.
45-89	14-5/8"	4"	TP-154	8
45-90	20-1/2"	4"	214-24	8
45-91	11-3/4"	4"	TP-124	16
45-93	17-1/2"	4"	TP-184	10
45-94	8-3/4"	4"	TP-94	24
45-95	11-3/4"	8"	128-15	12

Replace old worn out cabinet drawers with plastic drawer inserts. Also replaces Old Style Triangle Pacific. A packing fee will be assessed on orders with less than carton quantity.

## MONORAIL

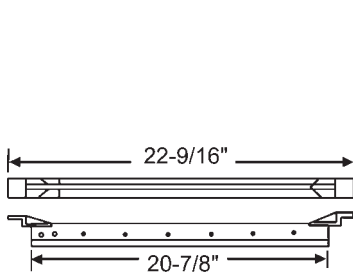

**45-96**

## DRAWER SLIDES



**45-416**  
22" Drawer Slides. White

## DRAWER GUIDES AND BRACKETS

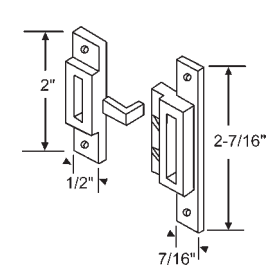

**45-48**  
Front and Rear guide set for 45-96 monorail and drawer inserts.

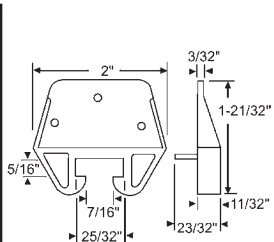

**45-1**  
Drawer guide  
Old KD-01

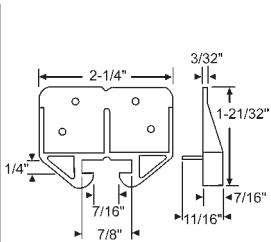

**45-15**  
Drawer guide

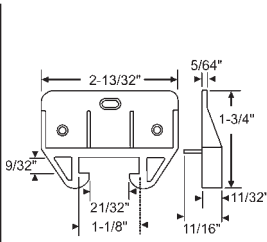

**45-6**  
Drawer guide  
Old KD-06

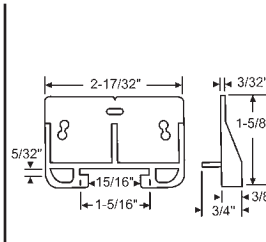

**45-14**  
Drawer guide  
Old KD-14



## DRAWER GUIDES AND BRACKETS

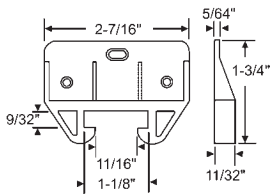

**45-7**  
Drawer guide  
Old KD-07

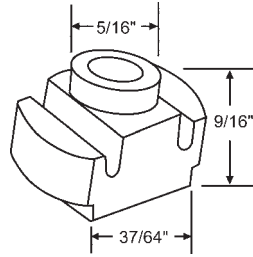

**900-9936**  
Drawer guide

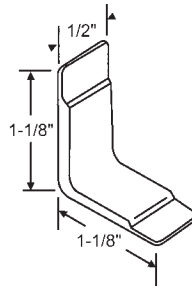

**45-52**  
Drawer Guide  
Nylon

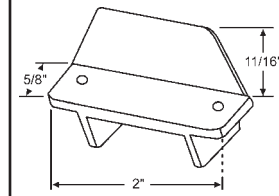

**45-10**  
Drawer Guide

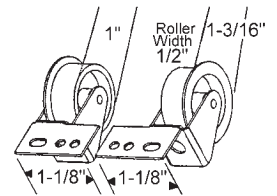

Part #	Hand
900-11808LH	LH
900-11808RH	RH

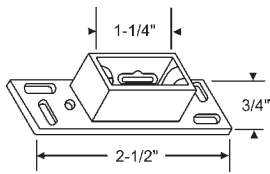

**45-9**  
Drawer Mounting Bracket

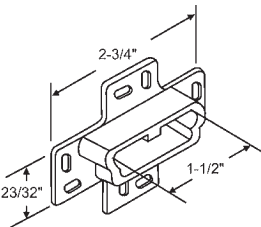

**45-23**  
Drawer Mounting Bracket

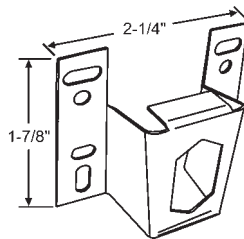

**900-11843**

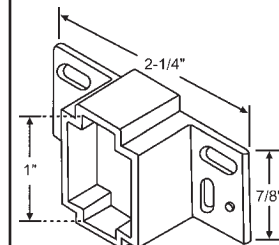

**45-16**  
Drawer Bracket

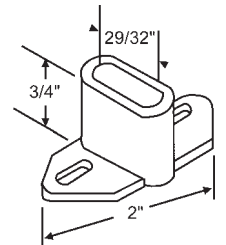

**45-26**  
Drawer Bracket

## SOCKETS

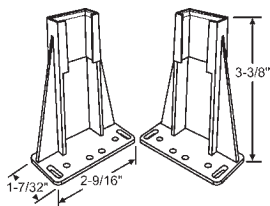

**45-582**  
Rear Mounting Bracket Set  
White Plastic

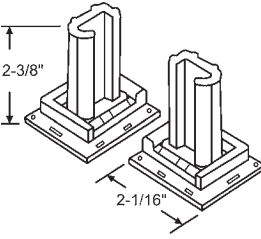

**45-203**  
Adjustable Rear Mount Drawer  
Slide Socket Set

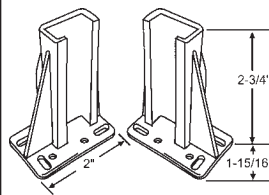

**45-229**  
Rear Mount Drawer  
Slide Socket Set

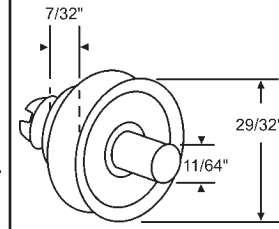

**45-98**  
Drawer Roller with Axle

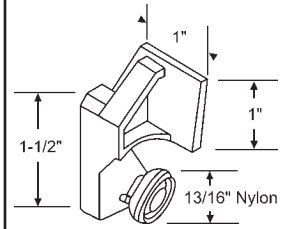

**45-19**  
Cabinet Roller  
**AJAX**

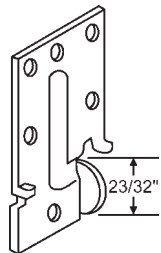

**900-17778**  
Roller Bracket  
No Longer Available.  
Use: 900-17778NS

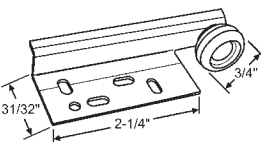

**900-17778NS**  
Roller Bracket. New Style

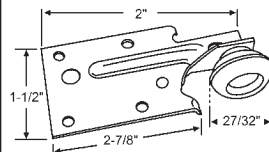

**45-24**  
Drawer Roller. Nylon Roller

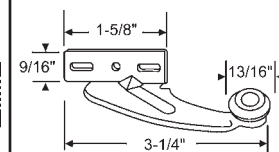

**45-18**

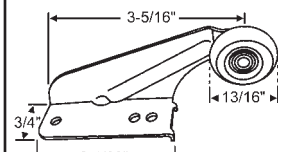

**45-17-2**  
Sold & Bagged in Pairs

# CABINET HARDWARE

## ROLLERS

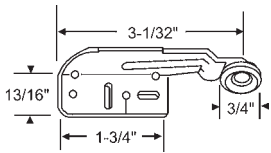

**45-25**

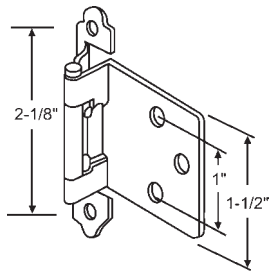

Part #	Finish
900-8910AB	Antique Brass

Pair with Screws and Pads

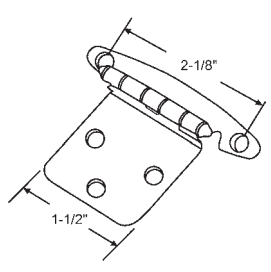

Part #	Finish
45-235PB	Polished Brass
45-235AB	Antique Brass

Flush Mount, Free Swinging Hinge

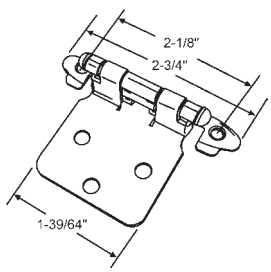

Part #	Finish
45-236PB	Polished Brass
45-236AB	Antique Brass

Flush Mount Self-Closing Hinge

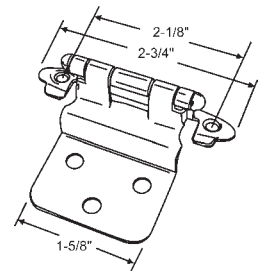

Part #	Finish
45-237PB	Polished Brass
45-237AB	Antique Brass

Offset Self-Closing Hinge

## HINGES

## MINI DOOR STRUTS

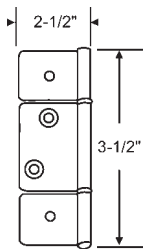

**8-356**  
Polished Brass 3 Leaf

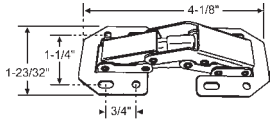

**45-225**  
Nickel Finish Self-Closing Hinge  
4 way Adjustable, 90° Opening

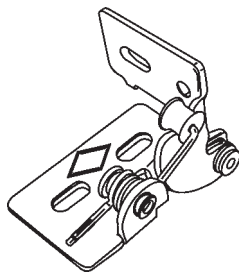

**45-230**  
Polished Chrome #5 Knife Hinge



**45-422**  
Concealed Hinge  
1/2" Overlay

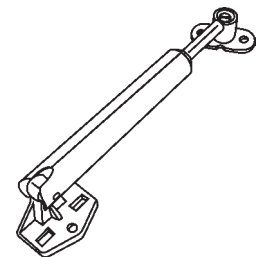

**45-208**  
Black Mini Door Strut, Nylon

## BUMPERS

## CABINET SHELF SUPPORTS AND BRACKETS

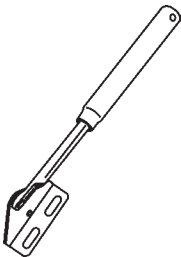

Part #	Finish
45-207	Satin Nickel
45-206	Antique English

Mini Door Strut, Steel

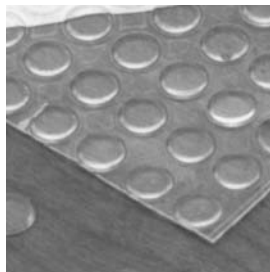

**45-240**  
Clear Plastic Bumper  
1/2" W x 1/16" H

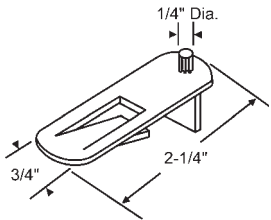

Part #	Finish
45-101W	White

For 1/2" Shelf

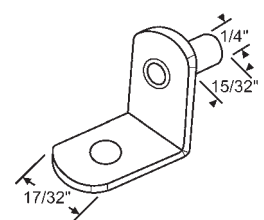

**900-10820**  
Shelf Support

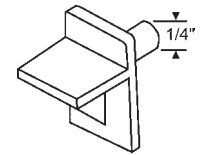

**45-99**  
Shelf Support  
Plastic

## LATCH AND CATCH

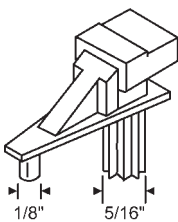

**45-100**  
Shelf Support

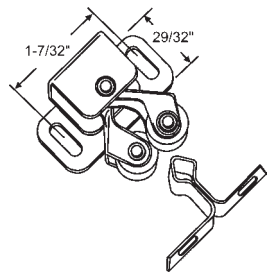

**45-216**  
Heavy Duty Double Roller, RV  
Cabinet Catch. Antique Copper

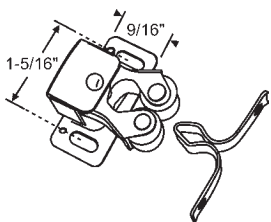

**900-6698**  
Cabinet Catch  
Zinc Nickel Plated

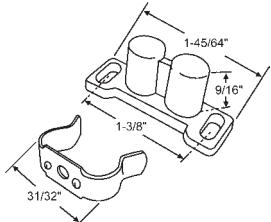

**900-10756**  
Solid Plastic White Barrel Catch

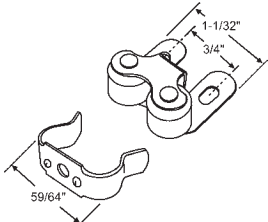

**900-9130**  
Roller Catch  
Zinc Nickel Plated

## LATCH AND CATCH

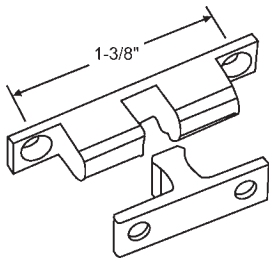

**45-227**  
Solid Brass Ball Catch

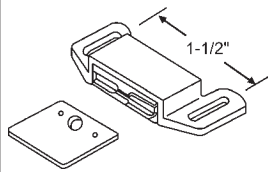

**900-6695**  
Tan Plastic High Power Magnetic Catch with Flat Plate

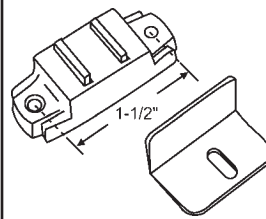

**900-11343**  
Tan Plastic High Power Magnetic Catch with Angle Plate

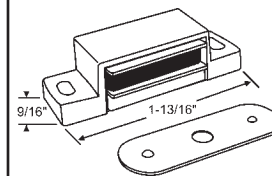

**45-194**  
Brown Plastic Magnetic Cabinet Door Catch with Flat Plate

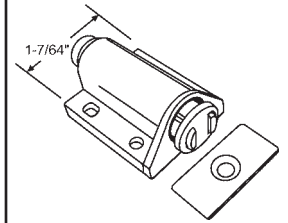

**45-239**  
Black Magnetic Touch Latch

## HANDLES AND KNOBS

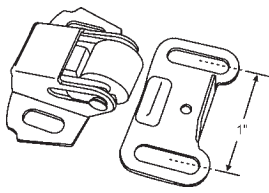

**45-130**  
Roller Catch and Strike  
Zinc Nickel Plated

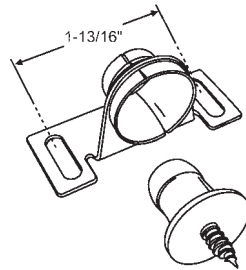

**45-245**  
Black Self Aligning Catch

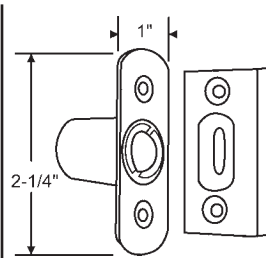

**900-10858R**  
Ball Catch and Strike  
with Rounded Corners  
Brass Plated

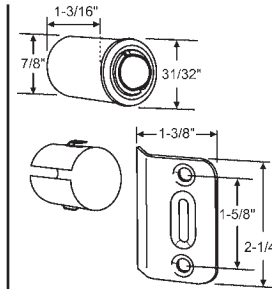

**900-10858DI**  
Dive In Bullet Ball Catch with  
Adjustable Tension Ball.  
Brass Plated



**8-471**  
1-1/8" Knob  
Polished Brass

## CABINET PULLS



**8-470**  
1-1/4" Knob  
Polished Brass



**8-482**  
1-1/4" Knob  
Satin Nickel Finish



Part #	Finish
45-354PC	Polished Chrome
45-354BRS	Polished Brass
45-354SNK	Satin Nickel
45-354SCH	Satin Chrome

1-1/4" Knob



Part #	Finish
45-355CH	Chrome
45-355PB	Polished Brass
45-355SNK	Satin Nickel

3" Cabinet Pull



**45-356SS**  
3" Cabinet Pull  
Stainless Steel

## ROSETTE



**45-424AB**  
3" Cabinet Pull  
Antique Brass

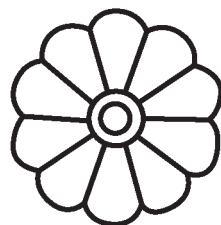

**900-20751**  
White with Screws

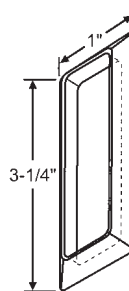

**900-17639-1**  
Adhesive Backed Finger Pull.  
Sold in Pairs. Clear

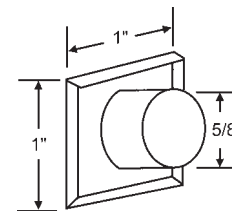

**900-16236**  
Mirror Pull  
Acrylic

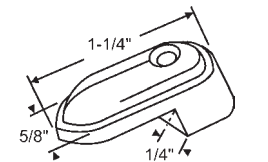

**900-13119**  
Tearable Mirror Clip with Screws

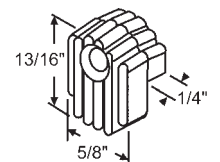

**900-9137**  
Ribbed Mirror Clip  
without Screws

# MAIL BOX LOCKS

## MULTI-CAM MAIL BOX LOCK KITS

### 97-75

For Interior Mail Boxes  
Bright Nickel Finish

Nut mounted lock meets specifications established by the U.S. Postal Service. Counter clockwise cam turn to open. Furnished with two keys, five different cams shown below, cam screw, mounting nut and instructions. Assemble with cam that matches lock. Keyway NA 14

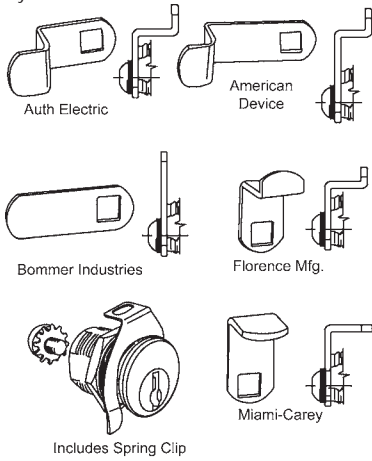

### 97-17

For Outside Mail Boxes  
Bright Nickel Finish

Keyway Dust Shutter protects mechanism from the elements. Lock has dual slots for mounting indoor using spring clip. Clockwise cam turn to open. Furnished with three keys, five different cams shown below, nut, lock washer, spring clip and instructions. Assemble with cam that matches present lock. Keyway NA 14

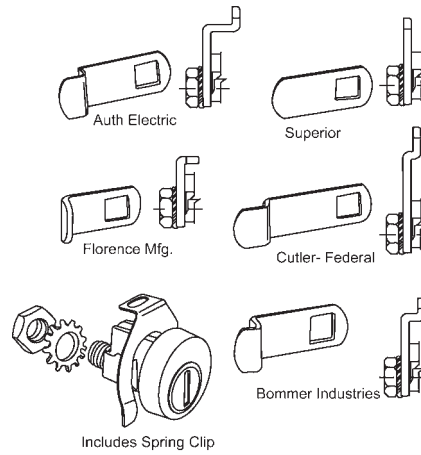

### 97-28

Replacement for Hudson #PT812

Multi-Cam Mail Box Lock Kit a suitable replacement for hudson #PT812. Hex nut mounted. Meets U.S. Postal Service specifications. 90° CCW cam rotation. Key removable in locked position only. Furnished with 3 keys, 5 cams, and all necessary mounting hardware. Keyway HL 1 - Nickel finish

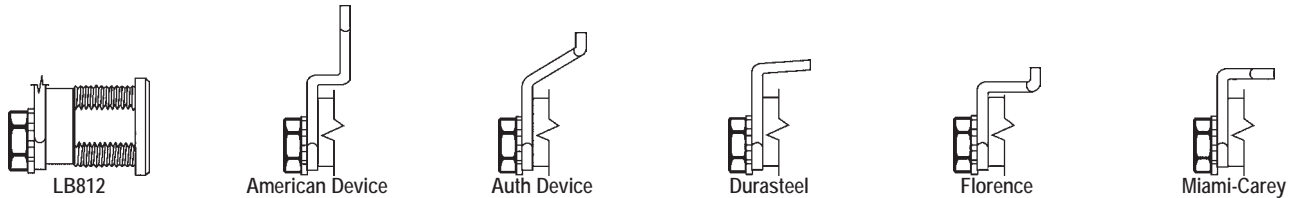

## FIXED CAM MAIL BOX LOCKS

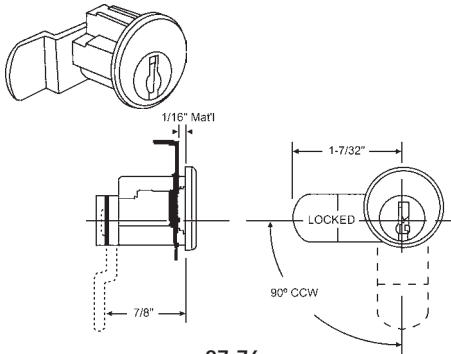

### 97-76

Bommer. Bright Chrome  
Locked Cam Position - Left. Keyway NA14

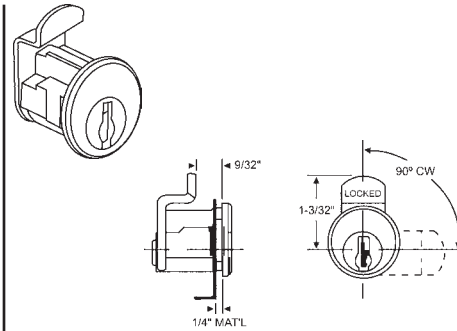

### 97-77

Florence Mfg. Bright Chrome.  
Locked Cam Position - Up. Keyway NA14

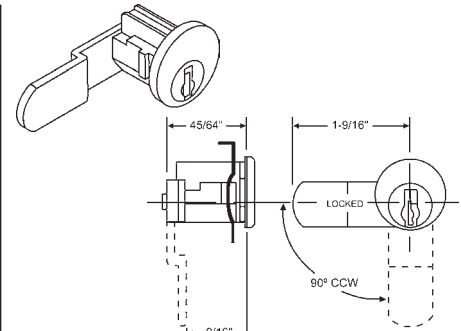

### 97-20

Cutler Federal. Bright Chrome  
Locked Cam Position - Down. Keyway NA12

## FLAT MAILBOX LOCKS

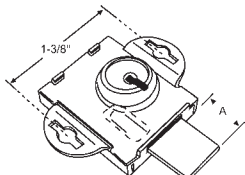

Part #	"A"
97-18	1/4"
97-19	1/2"

Replaces: Eagle #2616 1/4C, Ilco #4070A Fits: Auth, United, Florence. Bright Brass Finish Furnished with Two Keys.

## GARAGE DOOR HANDLES

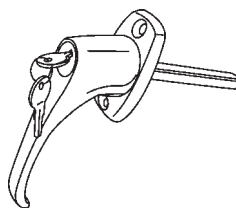

### 42-37

Chrome Plated with Keys

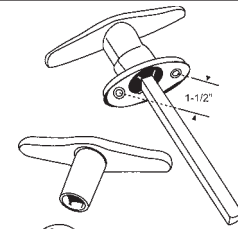

### 42-39

Chrome Plated Tee Handle Set

# TOILET PARTITION HARDWARE

## CONCEALED AND SURFACE MOUNTED LATCHES

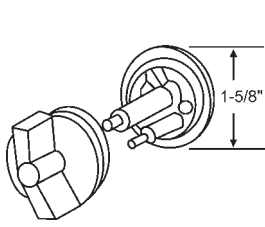

**91-8**  
Used with 91-129 Housing  
**AMERICAN METAL**

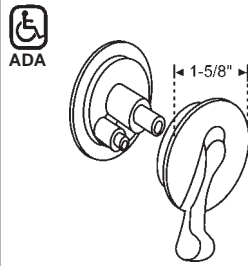

**91-330**  
Used with 91-129 Housing

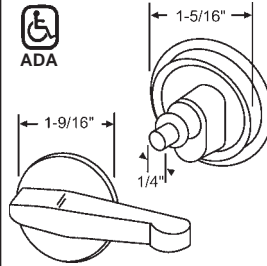

**91-84**  
**SANYMETAL**

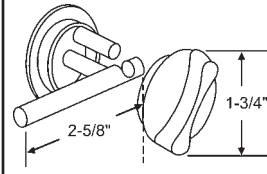

**91-130**  
For 1" Laminated Door

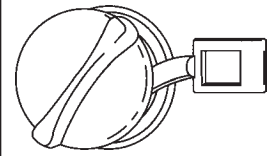

**91-131**  
With Flat Tip Bar. For 1" Steel Door

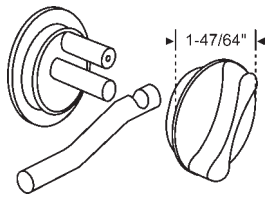

**91-198**  
For 1" Steel Door

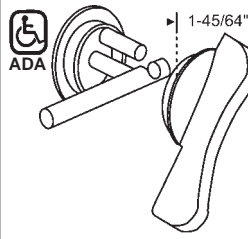

**91-209**  
For 1" Laminated Door

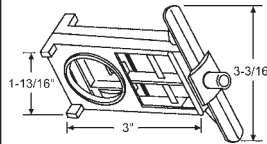

**91-129**  
Zinc Die Cast - Unplated

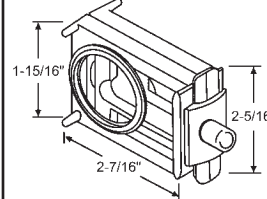

**91-187**  
Zinc Die Cast - Unplated

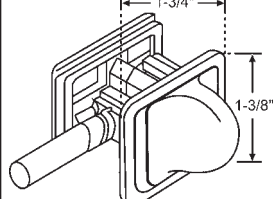

**91-292**  
For 1" Steel Door

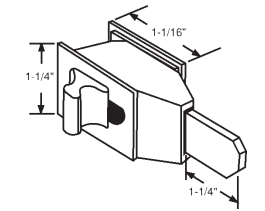

**900-18069**  
With Red and Green Indicator.  
For 1" Steel Door

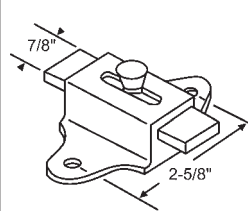

**91-83**

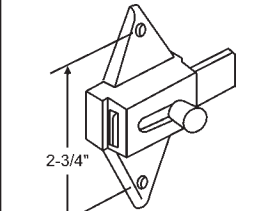

**91-79**

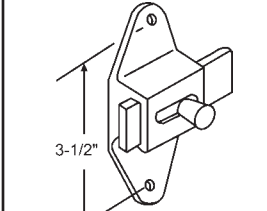

**91-4**

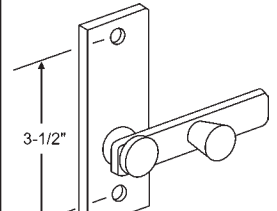

**91-80**

## CHROME PLATED DOOR PULLS, HOOKS AND DOOR STOPS

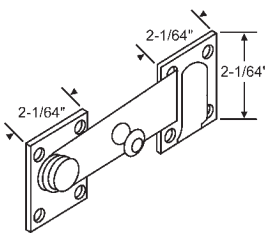

**900-20480**

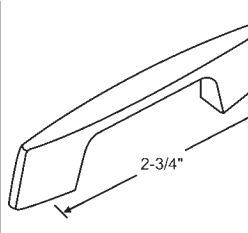

**91-125**  
Mounting Holes Tapped 8-32

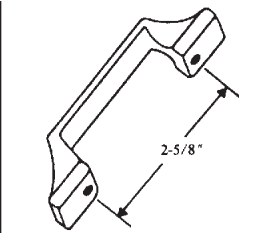

**91-90**  
Mounting Holes Tapped 10-24

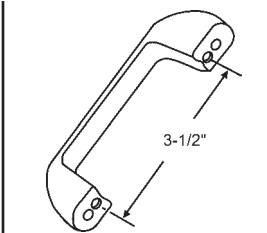

**91-9**  
Mounting Holes Tapped 10-24

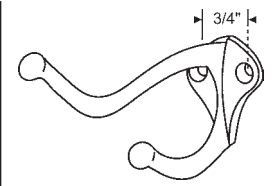

Part #	Finish
91-7	Chrome Plated
91-7BP	Brass Plated
91-7SS	Stainless Steel

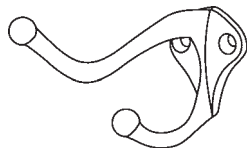

**91-7J**  
Heavy Duty. 7/32" Hole Diameter

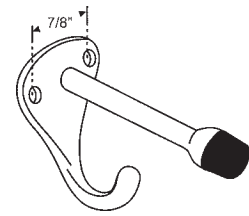

Part #	Finish
91-6	Chrome Plated
91-6SS	Stainless Steel

Coat Hook with Bumper  
7/32" Hole Diameter

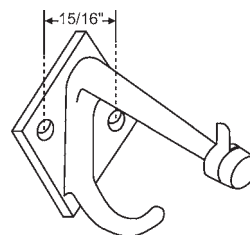

**91-255**  
1/4" Hole Diameter

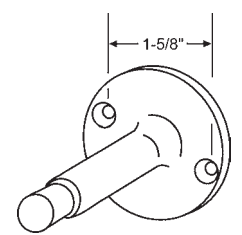

**91-10**  
2" High

# TOILET PARTITION HARDWARE

## CHROME PLATED KEEPERS AND STRIKES FOR 1-1/4" ROUND AND SQUARE POSTS

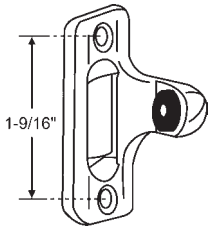

**91-290**  
Inswing/Outswing for Concealed Latch with Flat Bar

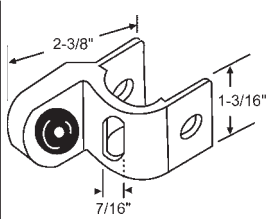

**91-5**  
Inswing/Outswing for Concealed Latch with Round Bar

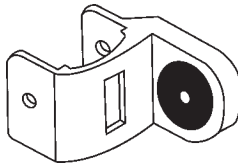

**91-134**  
Inswing/Outswing for Concealed Latch with Flat Bar

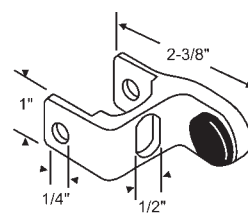

**91-87**  
Inswing/Outswing for Concealed Latch

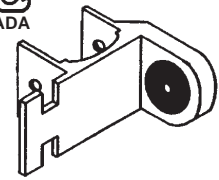

**91-253**  
Inswing for Throw Latch. Emergency Access

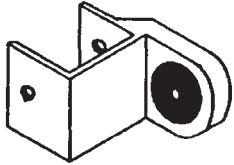

**91-137**  
Outswing for Slide Latch

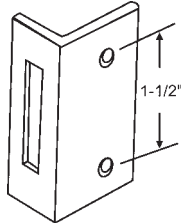

**900-10535**  
Inswing for Slide Latch, Chrome

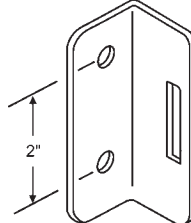

**91-89**  
Inswing for Slide Latch  
**SANYMETAL**

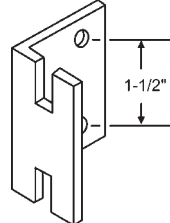

**91-81**  
Inswing for Throw Latch. Emergency Access

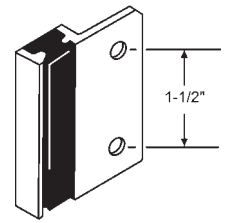

**91-82**  
Inswing/Outswing for Slide Latch

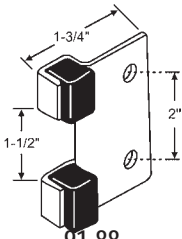

**91-88**  
Inswing/Outswing Strike  
**SANYMETAL**

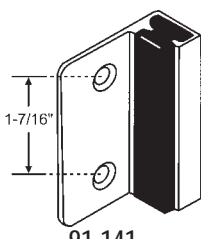

**91-141**  
Outswing for Slide Latch

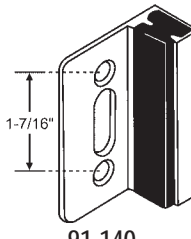

**91-140**  
Inswing/Outswing for Concealed Latch

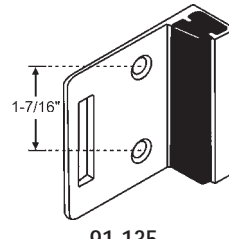

**91-135**  
Inswing for Slide Latch

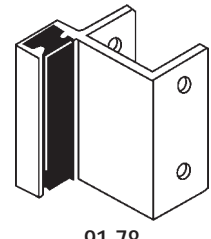

**91-78**  
Outswing for Slide Latch

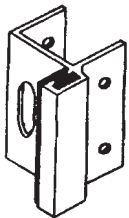

**91-133**  
Inswing/Outswing for Concealed Latch

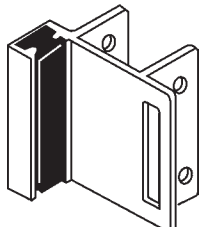

**91-26**  
Inswing for Slide Latch

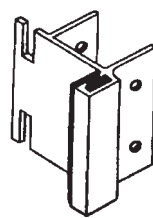

**91-132**  
Inswing for Throw Latch. Emergency Access

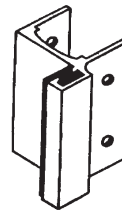

**91-217**  
Outswing for Slide Latch

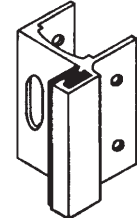

**91-55**  
Inswing/Outswing for Concealed Latch with Round Bar

## CHROME PLATED WRAP AROUND GRAVITY PIVOT HINGES FOR 1-1/4" ROUND AND SQUARE POSTS

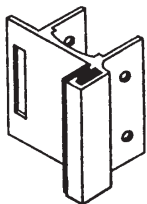

**91-237**  
Outswing for Slide Latch

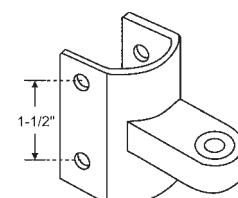
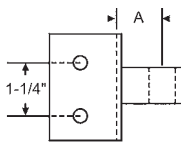

Part #	A
91-2	1-5/64"

**FLUSHMETAL**

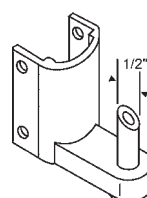

Part #	A
91-3	1-5/32"

**FLUSHMETAL**

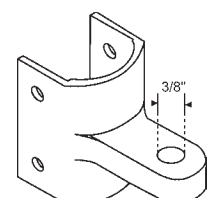

Part #	A
91-85	1-1/16"

**SANYMETAL**

# TOILET PARTITION HARDWARE

## CHROME PLATED WRAP AROUND GRAVITY PIVOT HINGES FOR 1-1/4" ROUND AND SQUARE POSTS

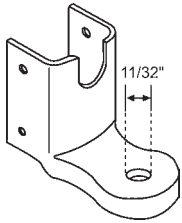

Part #	A
91-86	1-1/16"

**SANYMETAL**

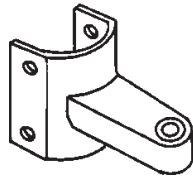

Part #	A
91-183	1-25/64"

**GENERAL/KNICKERBOCKER**

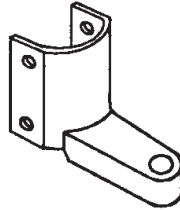

Part #	A
91-182	1-25/64"

**GENERAL/KNICKERBOCKER**

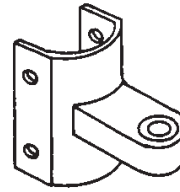

Part #	A
91-186	1-1/16"

**AMPCO/METPAR**

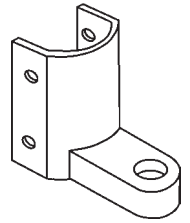

Part #	A
91-185	1-7/64"

**AMPCO/METPAR**

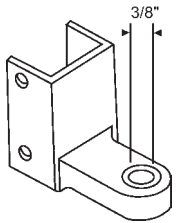

Part #	A
91-24	1-17/64"

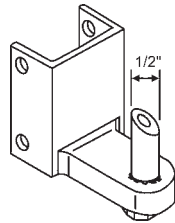

Part #	A
91-25	1-17/64"

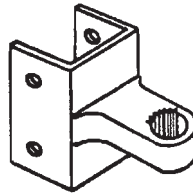

Part #	A
91-240	1-19/64"

Top and Bottom Hinge

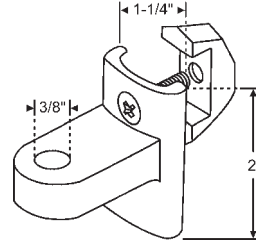

Use: 91-85

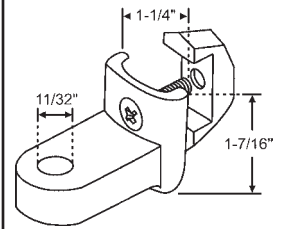

Use: 91-86

## SURFACE MOUNTED GRAVITY HINGE

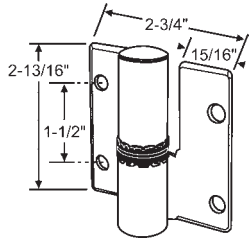

### 91-28

Round Barrel Hinge set for LH Inswing or RH Outswing. Chrome Plated. Includes 8 One Way Screws and 8 Barrel Nuts

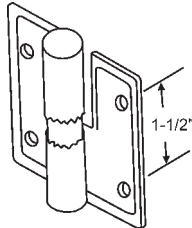

### 91-29

Round Barrel Hinge set for RH Inswing or LH Outswing. Chrome Plated. Includes 8 One Way Screws and 8 Barrel Nuts

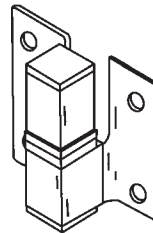

### 91-173

Square Barrel Hinge set for RH Inswing or LH Outswing. Cast Stainless Steel. Satin Finish

### 91-199

Square Barrel Hinge set for LH Inswing or RH Outswing. Cast Stainless Steel. Satin Finish

## CHROME PLATED WALL BRACKETS

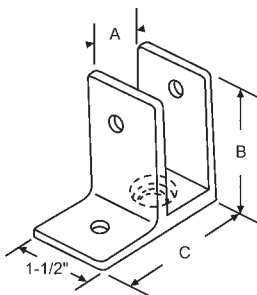

Part #	A	B	C
91-15	1"	2-1/2"	2-21/32"
91-16	1-1/4"	2-1/2"	2-3/4"
91-288	1-1/4"	3-1/2"	2-3/4"

One Ear

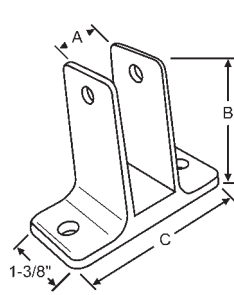

Part #	A	B	C
91-323	3/4"	2-1/2"	3"
91-367	1-1/4"	3-1/2"	4"

Two Ears

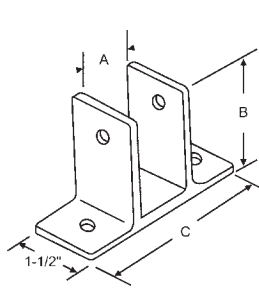

Part #	A	B	C
91-17	1"	2-1/2"	4"
91-97	1"	3-1/2"	4"
91-18	1-1/4"	2-1/2"	4"

Two Ears

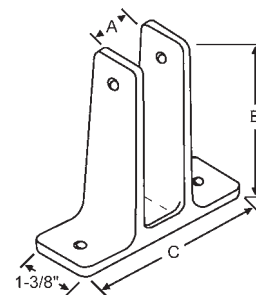

Part #	A	B	C
91-160	1"	3-1/2"	4"
91-161	1-1/4"	3-1/2"	4"

Screen Brackets

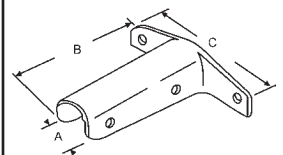

Part #	A	B	C
91-159	1"	12"	7"
91-11	1-1/4"	6"	6-1/4"

Wing Brackets

# TOILET PARTITION HARDWARE

## CHROME PLATED U - BRACKETS

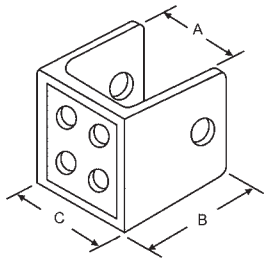

Part #	A	B	C
91-76	7/8"	1-3/8"	1-5/32"
91-12	1"	1-3/8"	1-1/4"
91-167	1-1/4"	1-3/8"	1-1/2"

## REPLACEMENT PILASTER SHOES

**Square Edge** 1-1/4" Thick Pilaster Shoes  
Open Front w/Holes. 22 Gauge Stainless Steel. Satin Finish

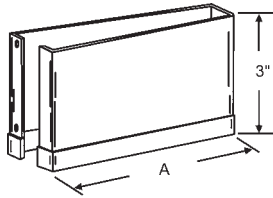

Part #	"A"
91-31	2"
91-33	3"
91-35	4"
91-37	5"
91-39	6"
91-41	7"
91-43	8"
91-45	10"
91-47	12"

**Round Edge** 1-1/4" Thick Pilaster Shoes  
Open Front w/Holes. 22 Gauge Stainless Steel. Satin Finish

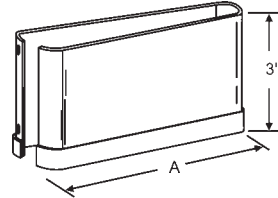

Part #	"A"
91-30	2"
91-32	3"
91-34	4"
91-36	5"
91-38	6"
91-40	7"
91-42	8"
91-44	10"
91-46	12"

## DOOR INSERTS

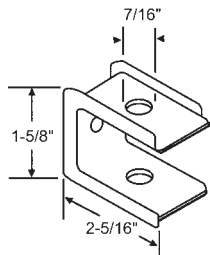

**91-72**

Top -for 1" Square Edge Door  
Chrome Plated

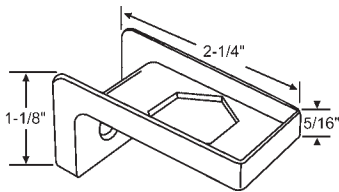

**91-117**

Bottom -for 1" Square Edge Door  
Chrome Plated

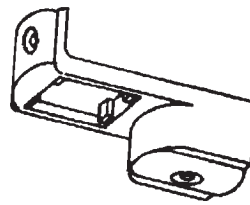

**91-252**

Bottom -for 1" Round Edge  
Metal Door. Unplated  
**FLUSHMETAL**

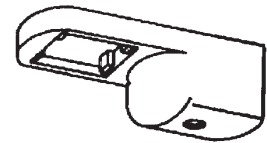

**900-14906**

Bottom -for 1" Round Edge Metal Door.

**AMPCO/METPAR**

## CAMS, PINTLES AND HINGE PINS

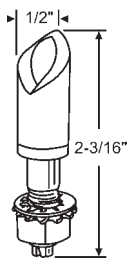

**91-102B**

Used with 91-114 and 91-191

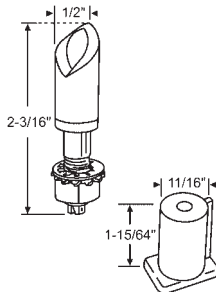

**91-102**

Set

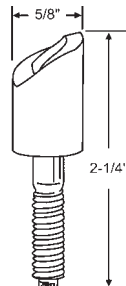

**91-148**

Used with 91-113, 91-190  
and 91-189

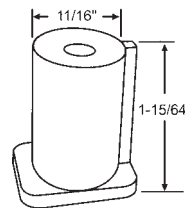

**91-191**

White Plastic. Fits Insert 91-73

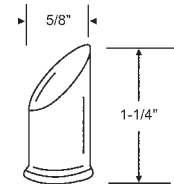

**91-114**

White Plastic. Fits Insert 91-153

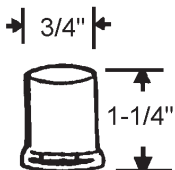

**91-113**

White Plastic. Fits Insert 91-117

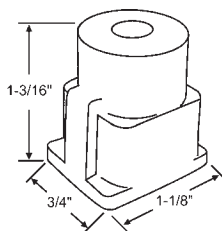

**91-189**

White Plastic

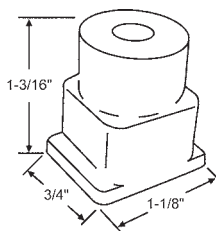

**91-190**

White Plastic



**91-313**

Nylon  
**HADRIAN**



**91-314**

**HADRIAN**



# TOILET PARTITION HARDWARE

## CAMS, PINTLES AND HINGE PINS

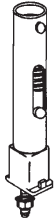

**91-152**  
**METPAR**

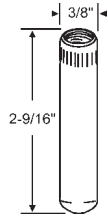

**91-96**  
Plastic  
**SANYMETAL**

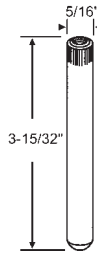

**91-1**



**91-71**  
Hinge Bracket for Plastic  
Laminated Pilasters



**91-261**  
**GENERAL**

## CHROME PLATED ALCOVE CLIPS, HEAD RAIL, END PLUGS AND BRACKETS

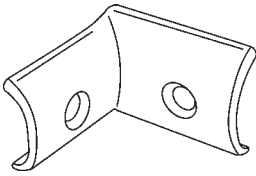

**91-328**  
For 1" to 1-1/4" Post. Right Angle  
Curved Molding  
**FLUSH METAL**

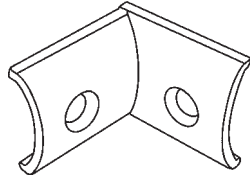

**91-264**  
Alcove Right Angle  
Curved Molding  
**METPAR**

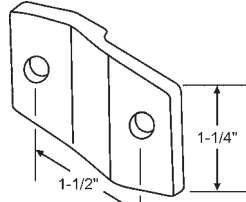

**91-70**  
Alcove 1-1/4" Offset (1/8" per  
side). For all Size Posts

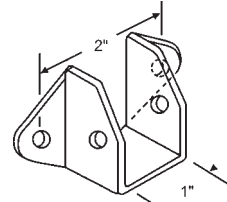

**91-13**  
Headrail Bracket

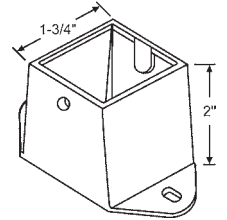

**91-21**  
Pilaster Shoe for 1-3/4"  
Square Tube

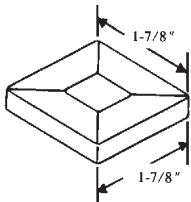

**91-20**  
1-3/4" Nylon Square Post Cap

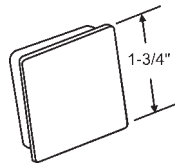

**91-116**  
1-3/4" Nylon Square Post Plug

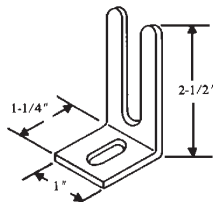

**91-22**  
Floor Bracket

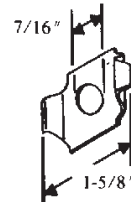

**91-23**  
Spring Clip

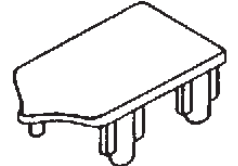

**91-63**  
Anti-Grip End Plug for all Size  
Handrails

## ONE-WAY SCREW REMOVER

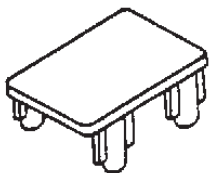

**91-64**  
Rectangular End plug  
for 1" Handrail

If you've tried to remove One-Way Tamper-Proof Screws from toilet partition, locks, fixtures and assemblies... you know the frustration involved. NO MORE DRILLING, POUNDING, PULLING, OR CHISELING... that wastes time, bruises knuckles and causes costly hardware damage. Highly praised by thousands of locksmiths, maintenance and service personnel, contractors and other professionals as a VALUABLE TOOL NEEDED FOR YEARS!

Part #	Screw Size
59-15	6-8
59-16	8-10
59-17	12-14

Three sizes available to fit all one-way screws.

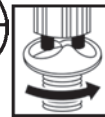
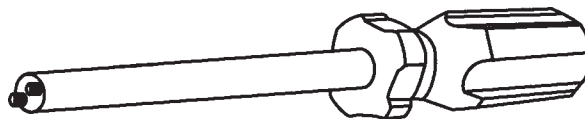

**Easy to Use**  
Works like an ordinary screwdriver. "No Slip" tip design provides maximum holding power until screw is removed.

## CHROME PLATED TOILET PARTITION FASTENERS

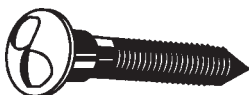

Part #	Screw Size
20-291	10-24 Thread x 15/16" Long
20-187	10-24 Thread x 1-3/16" Long
20-185	8-32 Thread x 1-3/8" Long

One Way Screws



Part #	Screw Size
20-293	10-24 Thread x 5/8" Long
20-186	10-24 Thread x 1/2" Long
20-186US	8-32 Thread x 1/2" Long (Not Slotted)

Barrel Nut



Part #	Screw Size
20-366	#10 x 3/4" Long
20-204	#10 x 1" Long
20-362	#10 x 5/8" Long

Self Tapping Screws

# COMMERCIAL DOOR/STOREFRONT HARDWARE

## MORTISE LOCKS

### DEADLATCH



Specify RH or LH  
(LH Shown)

### DEADBOLT



Non Handed

### HOOKBOLT



Non Handed

#### SPECIFICATIONS

- Function: Deadbolt, Hookbolt, Deadlatch
- Backset: 31/32", 1-1/8", 1-1/2"
- Face Plate: 1"W x 6-7/8" L - Aluminum
- Case Dimensions: 7/8"W x 6"L x Depth specific to backset
- Latchbolt: Deadbolt - 5/8"W x 2-7/8" L x 1-3/8" throw  
Hookbolt - 5/8"W x 1-3/8" L x 13/16" throw  
Deadlatch - 1/2"W x 1.0" L x 1/2" throw
- Deadlatches: Zinc alloy latchbolt with Delrin plastic insert, auxiliary bolt zinc die cast, deadlocks latchbolt and prevents manipulation

Part #	Hand	Function	Lock Backset	Case Depth
19-411LH	LH	Deadlatch	31/32"	1-5/8"
19-411RH	RH	Deadlatch	31/32"	1-5/8"
19-401LH	LH	Deadlatch	1-1/8"	1-25/32"
19-401RH	RH	Deadlatch	1-1/8"	1-25/32"
19-435	Non- Handed	Deadbolt	31/32"	1-5/8"
19-403	Non- Handed	Deadbolt	1-1/8"	1-25/32"
19-436	Non- Handed	Hookbolt	31/32"	1-5/8"
19-402	Non- Handed	Hookbolt	1-1/8"	1-25/32"
19-405	Non- Handed	Hookbolt	1-1/2"	2-1/4"

## FACEPLATES



### APPLICABLE DOOR STILES

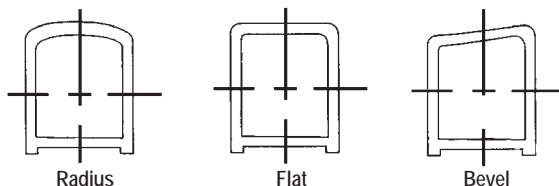

Faceplates for Mortise Lock with Deadbolt

Part #	Door Stile	Finish
19-432	Flat	Aluminum
19-432DBZ	Flat	Bronze
19-420	LH Bevel	Aluminum
19-420DBZ	LH Bevel	Bronze
19-421	RH Bevel	Aluminum
19-421DBZ	RH Bevel	Bronze
19-416	Radius	Aluminum
19-416DBZ	Radius	Bronze
19-423	Radius w/Weather-strip	Aluminum
19-423DBZ	Radius w/Weather-strip	Bronze

Faceplates for Mortise Lock with Hookbolt

Part #	Door Stile	Finish
19-433	Flat	Aluminum
19-433DBZ	Flat	Bronze
19-418	LH Bevel	Aluminum
19-418DBZ	LH Bevel	Bronze
19-419	RH Bevel	Aluminum
19-419DBZ	RH Bevel	Bronze
19-417	Radius	Aluminum
19-417DBZ	Radius	Bronze
19-422	Radius w/Weather-strip	Aluminum
19-422DBZ	Radius w/Weather-strip	Bronze

Faceplates for Mortise Lock with Deadlatch

Part #	Door Stile	Finish
19-434	Flat	Aluminum
19-434DBZ	Flat	Bronze
19-413	LH Bevel	Aluminum
19-413DBZ	LH Bevel	Bronze
19-414	RH Bevel	Aluminum
19-414DBZ	RH Bevel	Bronze
19-412	Radius	Aluminum
19-412DBZ	Radius	Bronze
19-415	Radius w/Weather-strip	Aluminum
19-415DBZ	Radius w/Weather-strip	Bronze

# COMMERCIAL DOOR/STOREFRONT HARDWARE

## PUSH/PULL PADDLE



For use with 19-401 and 19-411 deadlatch or any other brand of narrow stile mortise deadlatch. Paddle is four way reversible, select application required by referring to chart below. Handing can be reversed on cam plug by removing C- clip and flipping the cam over and reinstalling C- clip.

### SPECIFICATIONS

- Paddle: Extruded aluminum
- Housing: Zinc alloy, black hard coat finish
- Operating assembly: Steel mechanism
- Hand: Non-handed, cam plug included - Reversible
- Standard package: Paddle arm, operating housing, binder posts, cam plug, self adhesive decals and mounting hardware.

### UNIVERSAL - 4 WAY REVERSIBLE

Type	Operation	Use
PULL - LH		Outside of left hand reverse door or inside of right hand
PUSH - LH		Outside of left hand door or inside of right hand reverse
PULL - RH		Outside of right hand reverse door or inside of left hand
PUSH - RH		Outside of right hand door or inside of left hand reverse

Part #	Finish
19-431	Aluminum
19-431BZ	Bronze

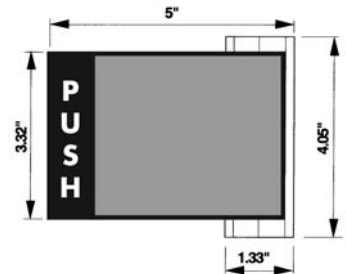

## LEVER HANDLE

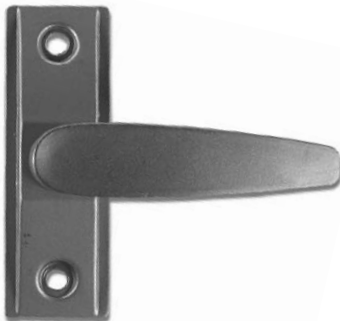

For use with 19-401 and 19-411 deadlatch or any other brand of narrow stile mortise deadlatch. Lever is reversible. Handing can be reversed on cam plug by removing C- clip and flipping the cam over and reinstalling C- clip. Cam plug is secured to lever by 2 hardened steel pins. Cam plug locks into deadlatch by use of set screw in deadlatch.

### SPECIFICATIONS

- Lever: Aluminum alloy cast
- Escutcheon: Aluminum 1-3/8" x 4", heavy duty spring mechanism prevents sagging of lever handle
- Spindle: Wrought steel, 1/4" square hardened heat treated
- Hand: Non-handed easily reversible
- Operation: Turning lever downward will activate deadlatch
- Standard package: Cam plug included, all mounting screws, templates and installation instructions

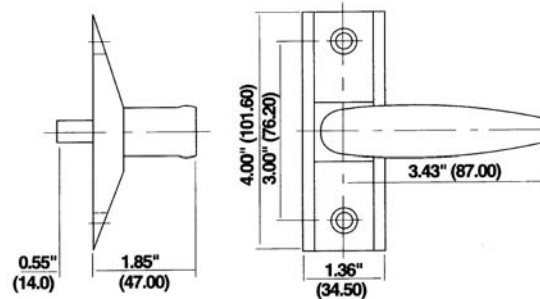

Part #	Finish
19-428	Aluminum
19-428BZ	Bronze

## STRIKES

Part #	Description	Finish
19-570	Single Strike	Aluminum
19-571	Double Strike	Aluminum

Both strikes are for use with 19-401 and 19-411 deadlatch or any other brand of narrow stile mortise deadlatch. Order double strike when converting a narrow stile lock to a deadlatch, to cover elongated slot in aluminum frame.

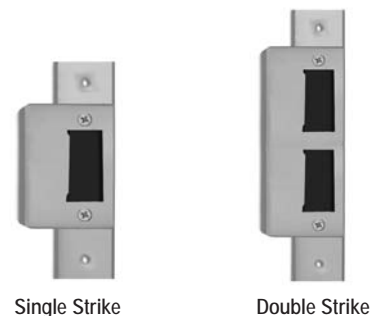

Single Strike

Double Strike

# COMMERCIAL DOOR/STOREFRONT HARDWARE

## CYLINDERS/TRIM RINGS/ COLLARS

### Mortise Cylinder

Part #	Description	Finish	Material
19-573	Key Cylinder (Keyed Alike in Pairs)	Aluminum	Zinc
19-573BZ	Key Cylinder (Keyed Alike in Pairs)	Bronze	Zinc
19-410	Key Cylinder (Keyed Different)	Aluminum	Zinc
19-410BZ	Key Cylinder (Keyed Different)	Bronze	Zinc
19-755	Key Cylinder (Keyed Different)	Aluminum	Brass
19-755BZ	Key Cylinder (Keyed Different)	Bronze	Brass
19-572	Key Cylinder (Keyed Alike)	Aluminum	Zinc
19-572BZ	Key Cylinder (Keyed Alike)	Bronze	Zinc
19-409	Thumbturn Cylinder	Aluminum	Zinc
19-409BZ	Thumbturn Cylinder	Bronze	Zinc
19-408	Dummy Cylinder	Aluminum	Zinc
19-408BZ	Dummy Cylinder	Bronze	Zinc



Keyed Mortise Cylinder



Thumbturn Mortise Cylinder



Dummy Mortise Cylinder

### SPECIFICATIONS

- Type: Mortise or Rim
- Finish: Zinc or Brass Mortise, Brass Rim
- Key cylinders - 5 pin Schlage "C" keyway
- Mortise cylinders are 1-5/32" diameter, 1" length
- Cam - MS A/R type, except DUM
- Rim cylinder, flat cut to size tail piece - Keyed different packed with collar ring, mounting plate, 2 screws,
- Key options
  - Keyed different
  - Keyed alike
  - Keyed alike in pairs



Keyed Rim Cylinder

### Rim Cylinders

Part #	Description	Finish	Material
19-568	Keyed Rim Cylinder	Aluminum	Brass
19-568BZ	Keyed Rim Cylinder	Bronze	Brass

Part #	Description	Finish
19-565	Extruded Trim Ring 5/16" (Solid)	Aluminum
19-565BZ	Extruded Trim Ring 5/16" (Solid)	Bronze
19-566	Extruded Trim Ring 5/16" (Hollow)	Aluminum
19-566BZ	Extruded Trim Ring 5/16" (Hollow)	Bronze
19-567	Cylinder Guard Anti-Wrench Collar	Aluminum
19-567BZ	Cylinder Guard Anti-Wrench Collar	Bronze



Extruded Trim Ring (Solid)



Stamped Trim Ring (Hollow)



Cylinder Guard Anti-Wrench Collar

## FLUSH BOLT

Mortise flush bolt for use on all commercial Storefront and architectural aluminum and glass narrow stile door. Made for easy installation, replaces most brands of Storefront flush bolt.

### SPECIFICATIONS

- Spring loaded lever action
- Rod extension- 7/8" throw
- Backset 3/4"
- 5/8" adjustment on rod length
- Face plate dimensions 15/16" x 4-1/2" with 5/32" radius corner
- Square 1/2" nylon tip with beveled corners to prevent binding
- Supplied with nylon keeper and fasteners

Part #	A	Rod Length	Finish
19-426	1/8"	10"	Aluminum
19-426BZ	1/8"	10"	Bronze
19-427	1/4"	10"	Aluminum
19-427BZ	1/4"	10"	Bronze
19-569	1/8"	16"	Aluminum
19-569BZ	1/8"	16"	Bronze

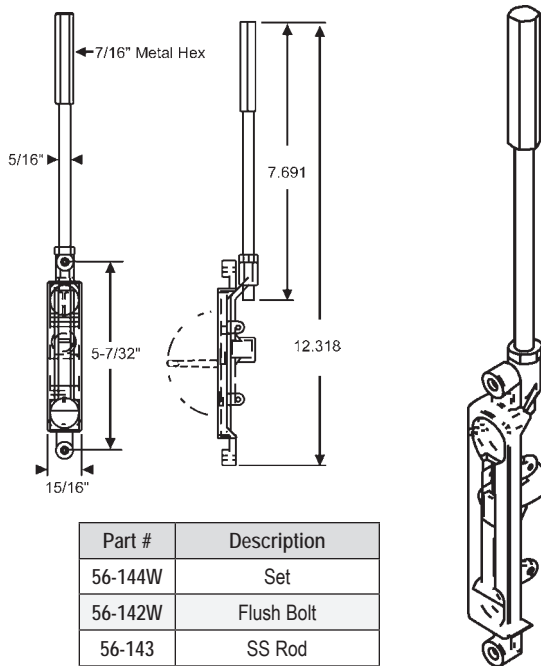
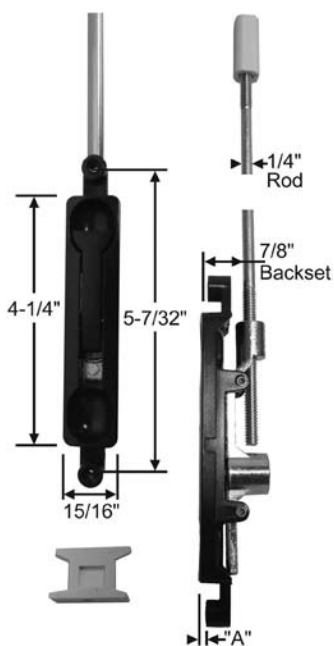

Part #	Description
56-144W	Set
56-142W	Flush Bolt
56-143	SS Rod

TRACO/SECURITY

# COMMERCIAL DOOR/STOREFRONT HARDWARE

## 3/4" OFFSET PIVOT

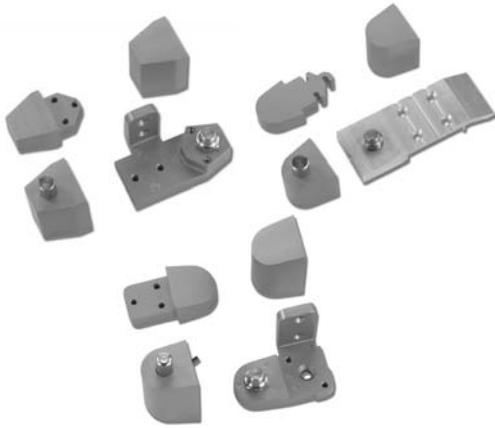

Offset Pivots are used for both flush face frame installation and recessed door applications. Pivots replace most major door manufacturers. Suitable for aluminum doors weighing up to 125 pounds. These pivots are engineered and designed for durability, style and are easy to install. To order pivot: For LHRB door order RH pivot. For RHRB door order LH pivot

### Left Hand Outswing (LH)

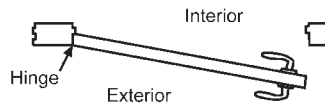

### Right Hand Outswing (RH)

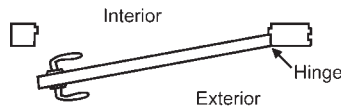

### SPECIFICATIONS

- 3/4" offset pivots for aluminum doors and frames
- Weather resistant
- Aluminum case construction
- Vertical adjustment 1/8"
- Full race ball bearing and design, provides smooth operation on bottom pivot door portion
- No sag, entire weight of doors rests on floor mounted pivot portion
- Completely tamper proof, yet easily removable, replaceable in unlocked position

### ARCH/VISTAWALL/TUBELITE/ARCADIA STYLE



Left Hand Shown

Part #	Application	Hand	Finish
19-259LH	1/8" Recessed Door	LH	Aluminum
19-259RH	1/8" Recessed Door	RH	Aluminum
19-259LHBZ	1/8" Recessed Door	LH	Bronze
19-259RHBZ	1/8" Recessed Door	RH	Bronze
19-736LH	For Flush Face Frame	LH	Aluminum
19-736RH	For Flush Face Frame	RH	Aluminum
19-736LHBZ	For Flush Face Frame	LH	Bronze
19-736RHBZ	For Flush Face Frame	RH	Bronze

Includes Screws

### PITCO/PPG STYLE



Right Hand Shown

Part #	Application	Hand	Finish
19-734LH	3/32" Recessed Door	LH	Aluminum
19-734RH	3/32" Recessed Door	RH	Aluminum
19-734LHBZ	3/32" Recessed Door	LH	Bronze
19-734RHBZ	3/32" Recessed Door	RH	Bronze

Includes Screws

### AMARLITE/REBCO STYLE



Right Hand Shown

Part #	Application	Hand	Finish
19-255LH	1/8" Recessed Door	LH	Aluminum
19-255RH	1/8" Recessed Door	RH	Aluminum
19-255LHBZ	1/8" Recessed Door	LH	Bronze
19-255RHBZ	1/8" Recessed Door	RH	Bronze

Includes Screws

# COMMERCIAL DOOR/STOREFRONT HARDWARE

## 3/4" OFFSET PIVOT

### ALDORA/ARCH STYLE

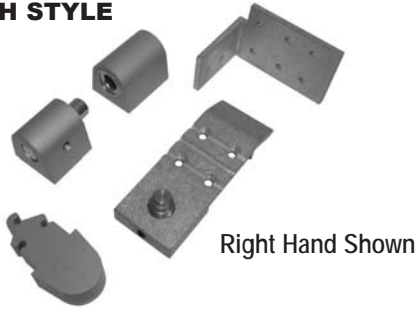

Part #	Application	Hand	Finish
19-406LH	1/8" Recessed Door	LH	Aluminum
19-406RH	1/8" Recessed Door	RH	Aluminum
19-406LHBZ	1/8" Recessed Door	LH	Bronze
19-406RHBZ	1/8" Recessed Door	RH	Bronze

Includes Screws

### US ALUM STYLE



Part #	Application	Hand	Finish
19-735LH	1/8" Recessed Door	LH	Aluminum
19-735RH	1/8" Recessed Door	RH	Aluminum
19-735LHBZ	1/8" Recessed Door	LH	Bronze
19-735RHBZ	1/8" Recessed Door	RH	Bronze

Includes Screws

### KAWNEER STYLE

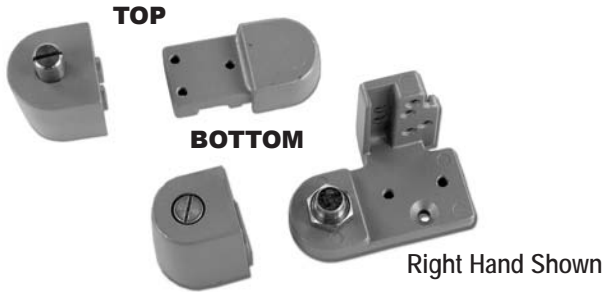

Part #	Application	Description	Hand	Finish
19-424T	1/8" Recessed Door	Top	-	Aluminum
19-424TBZ	1/8" Recessed Door	Top	-	Bronze
19-424LH	1/8" Recessed Door	Bottom	LH	Aluminum
19-424RH	1/8" Recessed Door	Bottom	RH	Aluminum
19-424LHBZ	1/8" Recessed Door	Bottom	LH	Bronze
19-424RHBZ	1/8" Recessed Door	Bottom	RH	Bronze

Includes Screws

### KAWNEER/BESAM STYLE

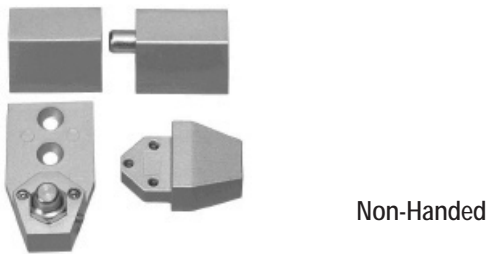

Part #	Application	Hand	Finish
19-737	1/8" Recessed Door	Non-Handed	Aluminum
19-737BZ	1/8" Recessed Door	Non-Handed	Bronze
19-258	For Flush Face Frame	Non-Handed	Aluminum
19-258BZ	For Flush Face Frame	Non-Handed	Bronze

Includes Screws

### OFFSET ALUMINUM PIVOT



Part #	Hand	Finish
19-612RH	Shown	Aluminum
19-612LH	Opposite	Aluminum
19-612RHBZ	Shown	Bronze
19-612LHBZ	Opposite	Bronze

YKK

### INTERMEDIATE ALUMINUM PIVOT



Part #	Finish
19-404	Bronze
19-404AL	Aluminum

Non-Handed

ARCH ALUMINUM



Part #	Finish
19-407	Bronze
19-407AL	Aluminum

Non-Handed

KAWNEER

# COMMERCIAL DOOR/STOREFRONT HARDWARE

## STAINLESS STEEL BUTT HINGES



### SPECIFICATIONS

- 4-1/2" x 4"
- Square Corner
- Ball Bearing
- Non Removable Pin
- Button Tip
- Packed & Sold in Sets of 3

Part #	Finish
8-474SSBN	Brushed Nickel
8-474SS	Brushed Chrome

Per Set of 3

## DELUXE HINGE KIT



### KIT CONTAINS

- (2) Roto Pin Hinges
- (12) One-Way Screws
- (4) Cover strips
- (1) Allen Wrench for vertical adjustment
- (2) 1/8" shims for Flush Door Application
- (1) Instruction Sheet

Deluxe Hinge Kits are the ideal choice for multiple application door solutions, when existing hardware fails. A quick and easy fix for any compromised opening.

### SPECIFICATIONS

- For commercial doors up to 500 lbs.
- Non handed full surface applications
- Made from high-tensile aluminum alloy
- Self-lubricating pin rotates on anti-friction bearings
- Hinges securely fastened with tamper proof screws
- Vertical adjustment screw
- Weather resistant
- Doors easily serviced without removal of hinge pin, lift off
- Packed and sold in pairs

Part #	Finish
19-574	Aluminum
19-574BZ	Bronze

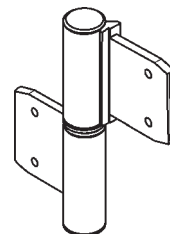
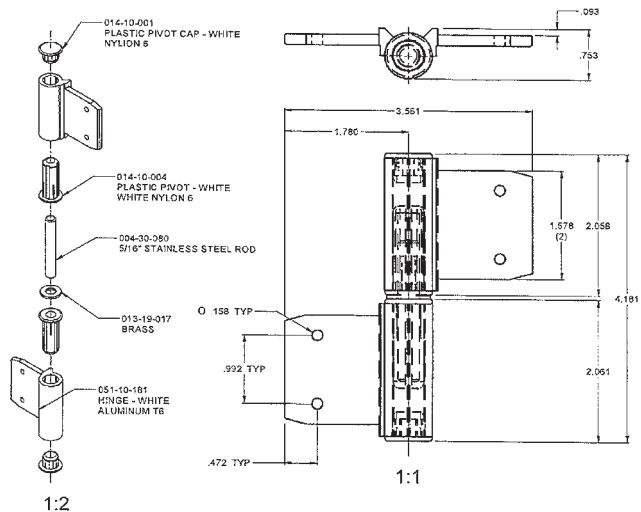

Part #	Finish	Hand
56-141RH	Mill	Shown
56-141LH	Mill	Opposite
56-141RHW	White	Shown
56-141LHW	White	Opposite
56-141RHBZ	Bronze	Shown
56-141LHBZ	Bronze	Opposite

TRACO/SECURITY

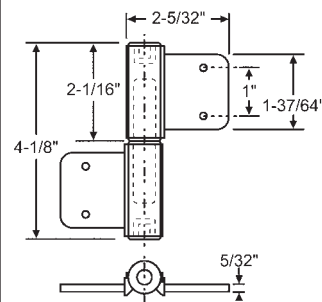

Part #	Hand
56-145LHW	Shown
56-145RHW	Opposite

White  
TRACO/SECURITY

## CONTINUOUS HINGES

- Available in full mortise and surface mount
- 6063 T6 Aluminum alloy, with interlocking extrusions
- Non-handed design
- 83" length
- Standard duty with 16 thrust type self-lubricating concealed bearings per hinge
- 200 lb. max weight capacity
- High degree of security
- Anodized aluminum after machining
- Through bolt and machine screws fixing
- Template hole patterns
- Minimum 5 Hinges Required or Combination

### Full Mortise Type

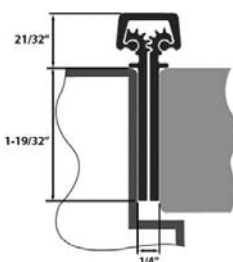

### FEATURES

- Full mortise type
- Flush mount
- Each hinge leaf has an alignment stop
- 1/4" clearance between door and frame

Part #	Finish
8-640	Aluminum
8-640BZ	Bronze

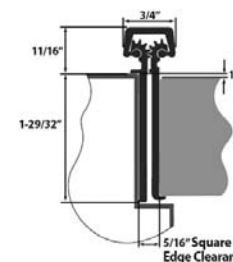

### FEATURES

- Full mortise type
- 1/16" door offset
- Door edge guard
- 5/16" clearance between door and frame

Part #	Finish
8-641	Aluminum
8-641BZ	Bronze

### Full Surface Type

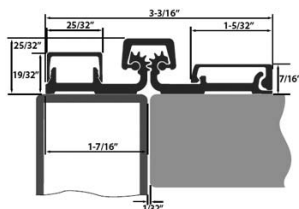

### FEATURES

- Full surface continuous hinge
- For narrow (limited) frame applications
- Tamper resistant removable door leaf cover
- 1/32" clearance between door and frame

Part #	Finish
8-639	Aluminum
8-639BZ	Bronze

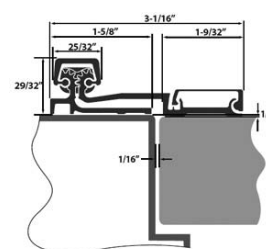

### FEATURES

- Full surface continuous hinge
- 1/32" door panel offset
- Tamper resistant removable door leaf cover
- 1/16" clearance between door and frame

Part #	Finish
8-638	Aluminum
8-638BZ	Bronze

# COMMERCIAL DOOR/STOREFRONT HARDWARE

## DOOR CLOSERS

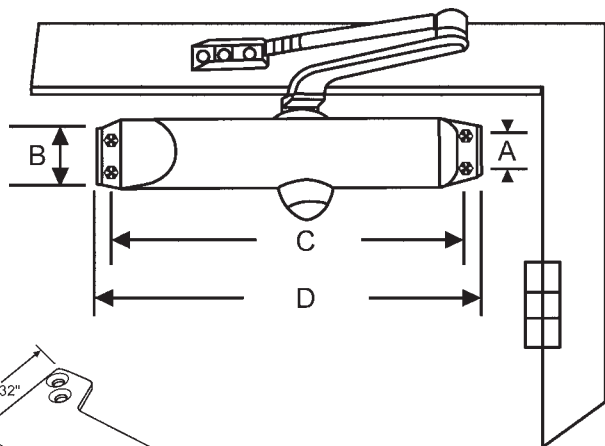

### FEATURES

- Surface mounted interior and exterior
- Size 3 is used on 3 ft. Wide interior door or 2-1/2 ft. Wide exterior door.
- Size 4 is used on 4 ft. Wide interior door or 3 ft. Wide exterior door.
- Non-handed
- Permanent lubricating hydraulic fluid
- Easy, smooth action
- Housing made of non-corroding aluminum.
- Narrow design is perfect for aluminum, glass, wood and other modern doors.

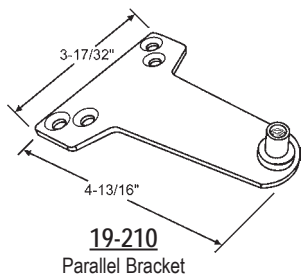

**19-210**  
Parallel Bracket

Part #	Size	A	B	C	D	Finish
18-70	#3	3/4"	1-3/4"	8-3/16"	8-15/16"	Aluminum (Silver)
18-72	#3	3/4"	1-3/4"	8-3/16"	8-15/16"	Bronze (Gold)
18-74	#3	3/4"	1-3/4"	8-3/16"	8-15/16"	Duranodic (Dk. Brown)
18-68	#4	3/4"	1-3/4"	9-1/16"	9-13/16"	Aluminum (Silver)
18-69	#4	3/4"	1-3/4"	9-1/16"	9-13/16"	Bronze (Gold)
18-73	#4	3/4"	1-3/4"	9-1/16"	9-13/16"	Duranodic (Dk. Brown)

### Dimensions for Closers with Backcheck Feature

Part #	Size	A	B	C	D	Finish
18-70BC	#3	3/4"	1-3/4"	8-3/16"	8-15/16"	Aluminum (Silver)
18-68BC	#4	3/4"	1-3/4"	9-1/16"	9-13/16"	Aluminum (Silver)

## POWER ADJUSTABLE CLOSER WITH BACK CHECK OR DELAYED ACTION

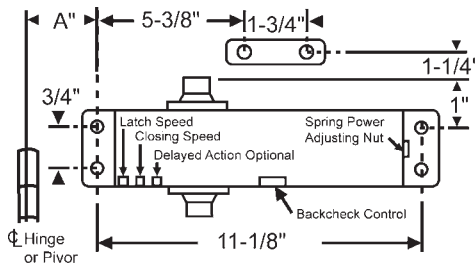
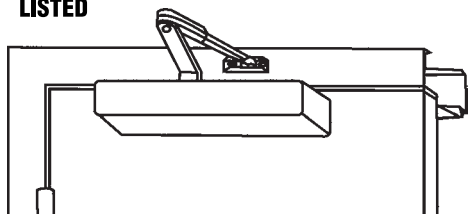

Opening	Dim. "A"
To 120°	7-3/32"
120° - 180°	3-15/16"

Part #	Finish
18-88	Aluminum (Silver)

**ANSI GRADE 1  
A - 156.4 STANDARDS  
APPLICABLE**

## DOOR STOPS

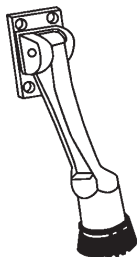

Part #	Color
19-136	Brass
19-137	Aluminum

5" Drop Down Door Stop

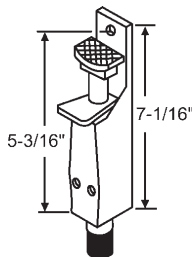

Part #	Color
19-135	Brass
19-138	Aluminum

## DOOR SILENCER

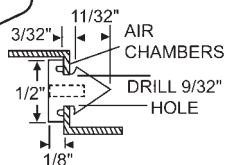
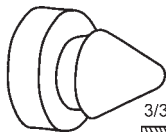

Part #	Finish
19-134	Gray

Rubber Grommet

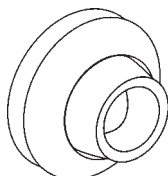

Part #	Color
19-140	Stainless Brushed

Screw mount, 2-1/2" diameter with gray vinyl bumper, concealed screw mount. Concave face to fit interior lock button. Furnished with anchor and screw.

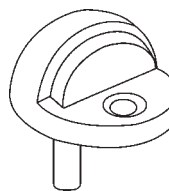

Part #	Color
19-141	Brushed Satin

Zinc Die Cast, Low Profile Door Stop. 1-3/4" Base, 1" Height, 1/8" Clearance.

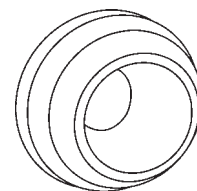

Part #	Color
19-139W	White
19-139	Gray

Adhesive backed, 1-7/8" diameter, gray rubber, peel-off label, pressure sensitive backed.





### SURFACE VERTICAL ROD

Our Surface Vertical Rod panic device is the perfect choice for double doors without mullions. Reversible for right or left hand doors, they are ideal for new construction or renovations. Our panics can be used in conjunction with any of our exit device trims.

Grade - ANSI A156.3 Grade 2

Part #	Finish
19-732	Aluminum
19-732BZ	Bronze
19-732SS	Stainless Steel

### FIRE RATED (3 HOURS)

Part #	Finish
19-733	Aluminum
19-733SS	Stainless Steel

### FEATURES

- MATERIAL: Extruded anodized aluminum push bar, stainless steel springs
- LATCH: Top Pullman type, Bottom bolt assembly
- DOOR HEIGHT: 7" standard
- BACKSET: 2 3/4" on 4 1/2" minimum stile width -if less than 4 1/2" backset becomes half of the exposed stile width
- STRIKE: Top-surface mounted, Bottom-flat mortise or into threshold, vertical/rim application use DBLST double dr. strike
- PROJECTION: 2 1/2" – 1 7/8" dogged
- STILE: 4 1/2" minimum
- HANDING: Reversible, non-handed
- DOOR THICKNESS: 1 3/4" standard
- DOOR WIDTH: 36", can be field sized to 30"
- MOUNTING HEIGHT: Recommended installation at 41" from finished floor to center line of push rail.
- FASTENERS: Furnished with sheet metal and machine screws
- CYLINDER NOT INCLUDED: Rim Cylinders and trim plates shown on page 394
- DOGGING: 1/2 turn hex key



### TOUCH BAR

"Touch bar" style exit devices are suitable for all doors (aluminum, hollow metal, or wood) where there is no projection on the face. Manufactured of extruded anodized aluminum, the touch bar is durable enough for the most demanding applications. Rim cylinder sold separately.

Grade - ANSI A156.3 Grade 2

Part #	Finish
19-730	Aluminum
19-730BZ	Bronze
19-730SS	Stainless Steel

### FIRE RATED (3 HOURS)

Part #	Finish
19-731	Aluminum
19-731BZ	Bronze
19-731SS	Stainless Steel

### FEATURES

- MATERIAL: Extruded anodized aluminum push bar, stainless steel springs
- LATCH: Stainless Steel, 3/4" throw - 5/8" deadlatch
- BACKSET: 2 3/4" Covers 161 prep, includes latch & Strike filler plates
- STRIKE: Surface mounted for 5/8" stop with shim
- PROJECTION: 2 1/2" – 1 7/8" dogged
- STILE: 4 1/4" minimum
- HANDING: Reversible, non-handed
- DOOR THICKNESS: 1 3/4" standard
- DOOR WIDTH: 36", can be field sized to 30"
- MOUNTING HEIGHT: Recommended installation at 41" from finished floor to center line of push rail.
- FASTENERS: Furnished with sheet metal and machine screws
- DOGGING: 1/2 turn hex key

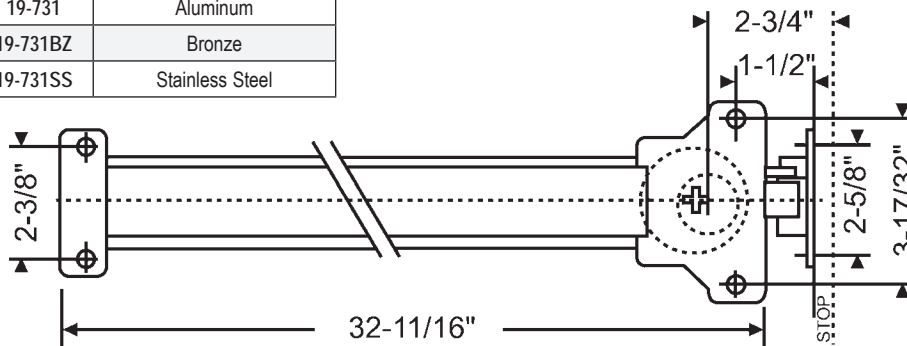

# COMMERCIAL DOOR/STOREFRONT HARDWARE

## NARROW STILE EXIT DEVICES

### CONCEALED VERTICAL ROD

These panic devices blend the utility of a vertical rod application with the appearance of a traditional panic device. It is non-handed and reversible with a contoured cross bar that will fit doors up to 42" wide and can be field sized to accommodate narrow doors.

Grade - ANSI A156.3 Grade 2

Part #	Finish
19-754	Aluminum
19-754BZ	Bronze



Brass Mortise Cylinder

Part #	Finish
19-755	Aluminum
19-755BZ	Bronze

Zinc Mortise Cylinder

Part #	Finish
19-410	Aluminum
19-410BZ	Bronze



Cylinder Mounting Trim

Part #	Finish
19-756	Aluminum
19-756BZ	Bronze

\*For exterior key application must order 19-756/19-756BZ.

Insert mortise cylinder in mounting trim and secure with locking ring nut, included.

#### FEATURES

- MATERIAL: Contoured anodized aluminum cross bar, stainless steel springs
- LATCH CASE: 1-1/4" wide x 7-1/4" long
- DOOR HEIGHT: 7" standard
- BACKSET: Center template on narrow door stile
- STRIKE: Top-flat mortise, Bottom-flat mortise or directly through threshold
- PROJECTION: 4-3/4"
- STILE: 1-7/8" minimum
- HANDING: Reversible, non-handed
- DOOR THICKNESS: 1-3/4" standard
- DOOR WIDTH: Up to 42"
- MOUNTING HEIGHT: 35-11/16" from floor to center line of the bottom latch case mounting stud
- FASTENERS: Furnished with sheet metal, machine screws and shoulder mounting studs with set screws
- CYLINDER: Accepts mortise type
- DOGGING: Inside- push up dog pin and rotate with screwdriver, Outside- by key cylinder

### TOUCH BAR

These "crash bar" style exit devices are suitable for narrow, medium or wide stile aluminum and hollow metal doors. Contoured cross bar that will fit doors up to 42" wide and can be field sized to accommodate narrow doors.

Grade - ANSI A156.3 Grade 2



Part #	Finish	Hand
19-747RH	Aluminum	Right
19-747LH	Aluminum	Left
19-748RHBZ	Bronze	Right
19-748LHBZ	Bronze	Left

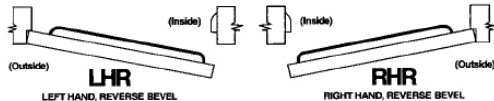

\*For Left Hand Reverse Door; order RH device  
\*For Right Hand Reverse Door; order LH device

#### FEATURES

- MATERIAL: Contoured anodized aluminum cross bar, stainless steel springs
- LATCH CASE: 1-1/4" wide x 7-1/4" long with 1/2" stainless throw
- BACKSET: 1-5/32" from edge of door to center line of device
- STRIKE: Rim mounted roller strike with shim
- PROJECTION: 4-3/4"
- STILE: 1-7/8" minimum
- HANDING: Handed, please specify RH or LH
- DOOR THICKNESS: 1-3/4" standard
- DOOR WIDTH: Up to 42"
- MOUNTING HEIGHT: Recommended installation at 39-13/32" from floor to center line of latch or strike assemblies
- FASTENERS: Furnished with sheet metal, machine screws and shoulder mounting studs with set screws
- CYLINDER: Accepts rim cylinder only
- DOGGING: Inside-push up dog pin rotate with screwdriver, Outside-by key cylinder

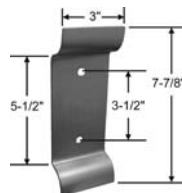
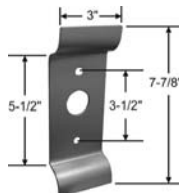

Night Latch Handle Set

Dummy Handle Set

Rim Cylinder

Pull Trim

Dummy Pull Trim

Exit Only Plate

Cylinder Mounting Trim

Part #	Finish
19-752	Aluminum
19-752BZ	Bronze

Part #	Finish
19-753	Aluminum
19-753BZ	Bronze

Part #	Finish
19-568	Aluminum
19-568BZ	Bronze

Part #	Finish
19-749	Aluminum
19-749BZ	Bronze

Part #	Finish
19-750	Aluminum
19-750BZ	Bronze

Part #	Finish
19-751	Aluminum
19-751BZ	Bronze

Part #	Finish
19-756	Aluminum
19-756BZ	Bronze

\*All trim applications for new door or existing hole less than 1-3/16"

"One-Stop" Source for

*current style*

*hard-to-find and*

*obsolete*

Window and Door  
Replacement Parts!

WE SPECIALIZE IN...

- Window Sash Balances & Accessories (Tube & Channel)
- Sliding Window Hardware
- Awning & Jalousie Window Hardware
- Casement, Project-Out & Hopper Window Hardware
- Window Screen Hardware
- Closet Door Hardware
- Patio Door & Screen Door Hardware
- Storm Door Hardware
- Shower Door Hardware

## SEND A SAMPLE

This catalog shows only a small sampling of the parts we offer. If you don't see the part you need, or are not sure you have identified the correct part number to order, then send a sample to the address on the front cover

## CUSTOM MADE MERCHANDISE

If you need a part which has been discontinued, send us a working sample. We will give you a quote on duplicating it.

## EASY ORDER INSTRUCTIONS FOR WINDOW BALANCES

## DELIVERY

Stock items shipped same day. Specialty items 2-6 weeks or as quoted.

---

### Terms & Conditions of Sale

#### Minimum Order

\$25.00 net per order. Under \$25.00 add \$5.00 service charge.

#### Prices

Subject to change without prior notice. It is our policy to keep our prices competitive - please tell us if they are not!

#### Title & Risk of Loss

Title and risk of loss shall pass to Buyer on delivery of goods to a carrier selected by Seller or a carrier requested by Buyer. Buyer shall accept and inspect all shipments immediately upon arrival and shall file claims with or against the carrier for any losses, shortages, or damages of any kind. All claims including shortages, must be filed in writing within ten days after receipt of goods.

#### Delays

Specified delivery dates are subject to availability of material and labor. Seller shall not be liable for and at its election, shall be excused from performance of orders if its failure to perform due to fire, flood, acts of God, explosion, labor difficulties, mechanical breakdown, accidents, prior commitments, priority of Government orders, or any other cause beyond the Seller's control. Any such reasons for delay shall extend the time for performance of the order by the number of days required to correct the cause of delay.

#### Returns

Material made to order is not returnable. Stock material is only returnable when permission has been granted by AMSCO, and is subject to handling and refinishing charges (25%). No fee will be charged if the order was shipped incorrectly. Shipping charges on all returned goods must be prepaid. We require invoice number and date of sale with returned goods and permission for return must be requested in writing within 30 days after receipt of merchandise.

#### Policy

AMSCO reserves the right in its sole discretion to refuse acceptance of any order from any source at any time. Quotations are valid for a period of thirty(30) days from the date of issue. Orders based on quotations which are more than thirty(30) days old shall not be accepted unless and until the original quotation is confirmed by AMSCO.

#### Terms

Net 30 days to approved firms. All other orders are to be prepaid. In the event that Amsco takes any action to enforce its legal rights in connection with any sale and purchase, or to collect any sums due therefrom, the Buyer shall pay all cost of any such action including, but not limited to, a reasonable attorney's fee and costs, and a reasonable attorney's fee and cost on appeal.

#### Service Charges

A minimum service charge of 1-1/2% per month will be assessed on all past due accounts. This service charge may be increased based upon current money market conditions.

ACADIA ACORN ACRO ACME AIRMMASTER ALESCO ALSCO ANACONDA ALUMA TRIM ALWINSEAL AMACOR AMERICAN CRAFTSMAN ANDERSEN ANDERSON ARCADIA	CAPITOL CARADCO CERTAINTED CHELSEA COLUMBIA CRAFTLINE CRESTLINE CROSSLY  DARYL DAYTON DECEUNINCK DEVAC DORCHESTER	GALLATIN/GAPCO GENERAL ALUMINUM GENERAL BRONZE GEORGIA PALM BEACH GEZE GRAHAM  HESS HOPES HOWARD  IDA INTERNATIONAL  JELD-WEN JGR JONES JORDAN  KAWNEER KELLER KENSINGTON KINCO KING KINRO	KRESTMARK  LAST RESORT LEALCO LOOK LOUISIANA PACIFIC LOXSCREEN LUPTON  MALTA MANNIX MARVIN METAL INDUSTRIES MI HOME PRODUCTS MIKRON MILCO MILLER MFG. MILGARD MOSS  NATIONAL NORANDEX NORCO PAN AM PEACHTREE	PECO PEERLESS PELLA PENNCO PGT PHILIPS PH TECH PORTALUME POZZI  QUAKER  REHAU RELIANT REMINGTON REPUBLIC REYNOLDS RIVERVIEW ROBERT E. LEE ROLLYSON ROYAL RUSCO S.D. DAVIS SEASONALL SILVERLINE	SLIMFOLD SLOCOMB SNE STANLEY STEPHEN LAURIE STORM WEATHER SUGAR CREEK SURVIVOR SWS INDUSTRIES  THERMALGARD TRACO-THREE RIVERS  UNIQUE  VBP VEKA VINYL BUILDING PROD. VINYLINER  WEATHERCRAFT WEATHER MASTER WEATHER SHIELD WENCO WIDING
---	--	--	--	--	---

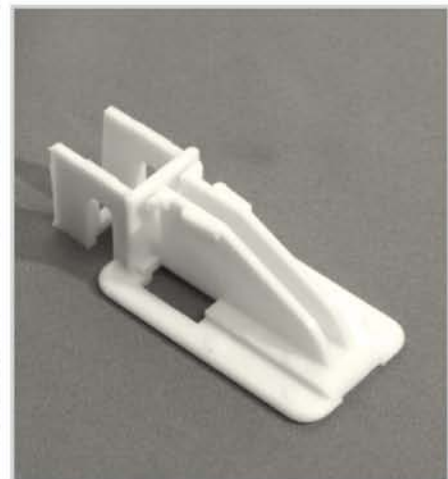

**THE ONE STOP SOURCE FOR ALL YOUR WINDOW & DOOR HARDWARE**



**27505 Ridge Road  
Damascus, MD 20872  
Phone: 1-800-992-4282  
Fax: 1-301-253-8949  
www.amscousa.com  
sales@amscousa.com**