

Sweep Locks & Sash Locks

In order by mounting hole width (single hole locks first).

Single Hole

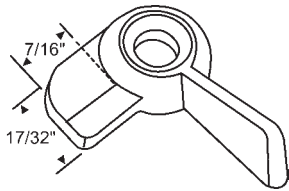

Part #	Finish
900-7277	Unfinished

Zinc Die Cast

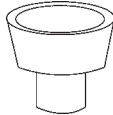
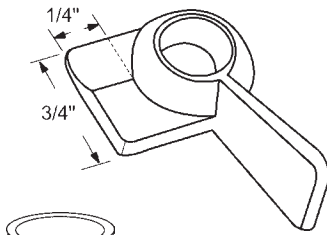

50-625
Plastic Bushing Insert

Lock only

Part #	Hand	Finish
50-624RH	Shown	Brite
50-624LH	Opposite	Brite

Lock with Bushing and Screw

Part #	Hand	Finish
50-624RHA	Shown	Brite
50-624LHA	Opposite	Brite

Zinc Die Cast

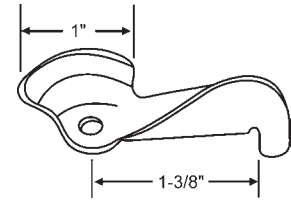

Part #	Hand
50-604	Shown

Stamped Steel

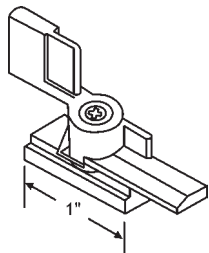

Part #	Finish
50-715	Unfinished

Zinc Die Cast
Crossly

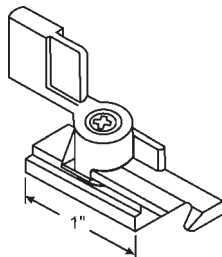

Part #	Finish
50-715H	Unfinished

Zinc Die Cast with Hook
Crossly

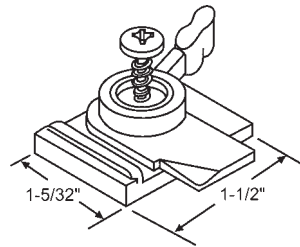

Part #	Hand	Finish
50-619RHA	Shown	White
50-619LHA	Opposite	White

Plastic
Thermalgard

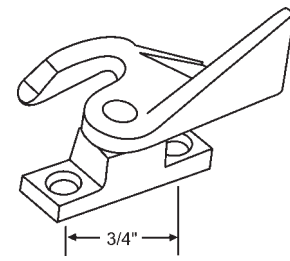

Part #	Finish
50-610	Unfinished

Zinc Die Cast. Use with 50-611 Keeper.
Portalume

7/8"

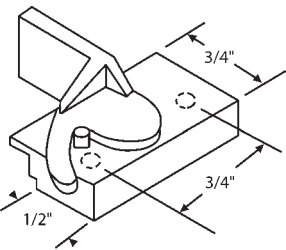

Part #	Hand	Finish
50-705	Shown	Unfinished
50-704	Opposite	Unfinished

Zinc Die Cast

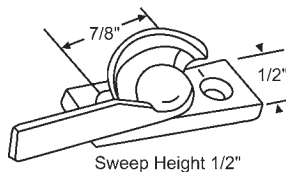

Part #	Hand	Finish
50-637	Shown	Brite
50-638	Opposite	Brite
50-637BR	Shown	Bronze

Zinc Die Cast. Use with 50-643 Keeper.
Stanley

1"

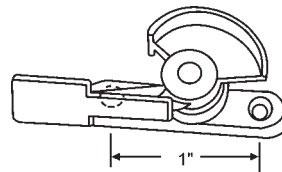

Part #	Finish
50-711	Unfinished

Zinc Die Cast. Use with 50-701 Keeper.

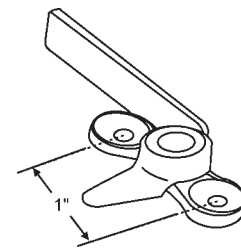

Part #	Finish
900-41WB	White Bronze

Bronze Casting
Ualco

1-1/4"

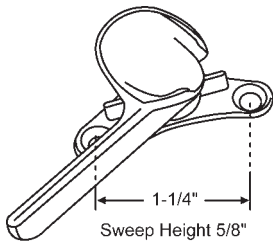

Part #	Finish
50-641	Brite

Zinc Die Cast. Use with 50-790 Keeper.
Kinco

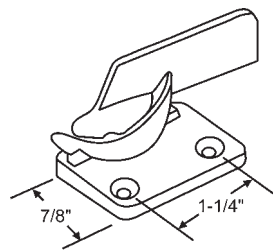

Part #	Finish
50-645	Brite

Zinc Die Cast. Use with 50-646 Keeper.
Seasonall

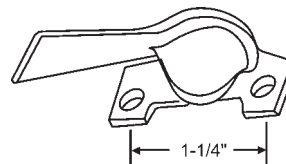

Sash Lock and Keeper

Part #	Finish
50-608A	White Bronze

Sash Lock Only

50-651	White Bronze
--------	--------------

Bronze Casting. Use with 50-609WB Keeper.

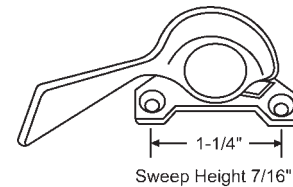

Sweep Height 7/16"

Part #	Finish
50-671	White Bronze

Bronze Casting
Use with 900-8505 Keeper.

Window Replacement Hardware

Sweep Locks & Sash Locks

1-1/4"

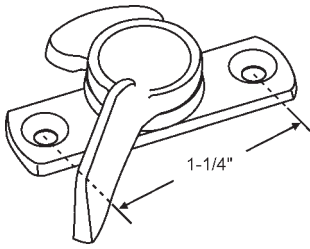

Part #	Finish
50-678	Brite

Die Cast
Rusco

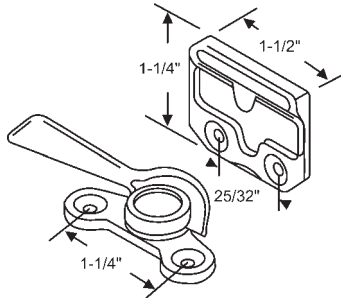

Part #	Finish
50-733	Unfinished

Zinc Die Cast. Includes Keeper
Alwinseal

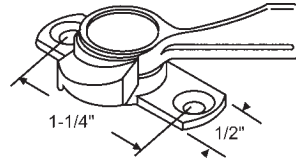

Part #	Finish
50-783B	Black

Height Graduates from 9/32" to 3/8" Max.
Zinc Die Cast
Rusco

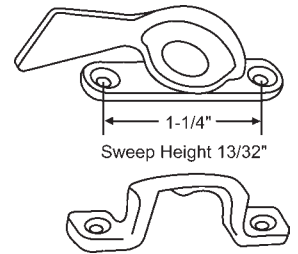

Part #	Finish
50-655A	White Bronze

Bronze Casting. Includes Keeper

1-3/8"

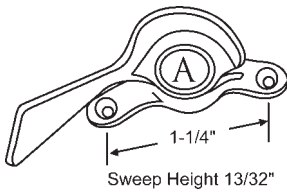

Sash Lock and Keeper

Part #	Finish
50-718A	White Bronze

Sash Lock Only

Part #	Finish
50-718	White Bronze

Bronze Casting. Use with 50-709 Keeper.

Alwinseal

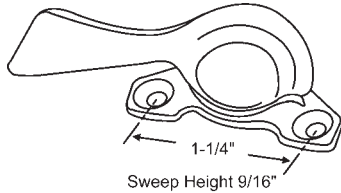

Sweep Height 9/16"

Part #	Finish
900-9589	White Bronze

Bronze Casting

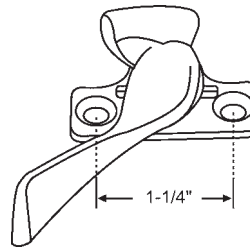

1-1/4"

Part #	Finish
900-7267	White Bronze

Bronze Casting

Window Master

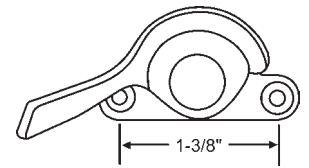

1-3/8"

Part #	Finish
900-8503	White Bronze

Bronze Casting. Sweep Height 7/16"

1-1/2"

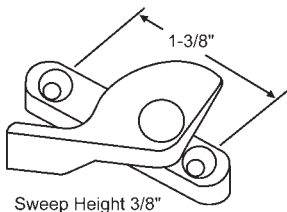

Sweep Height 3/8"

Part #	Finish
50-698	Unfinished

Zinc Die Cast

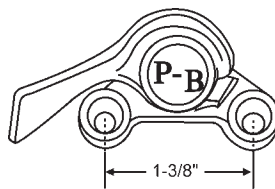

1-3/8"

Part #	Finish
900-9158	White Bronze

Bronze Casting. Sweep Height 3/8"

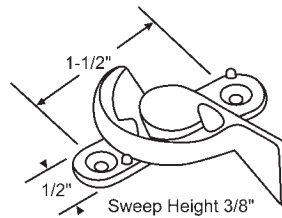

Sweep Height 3/8"

Part #	Finish
50-607	Unfinished

Zinc Die Cast

Keller

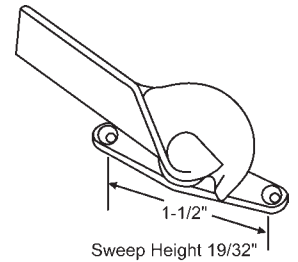

Sweep Height 19/32"

Part #	Hand	Finish
50-614	Shown	Brite
50-614RH	Opposite	Brite

Zinc Die Cast

Pan Am

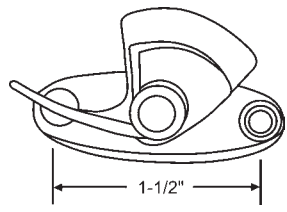

1-1/2"

Part #	Finish
50-627	Brite
50-627B	Bronze

Zinc Die Cast

Keller

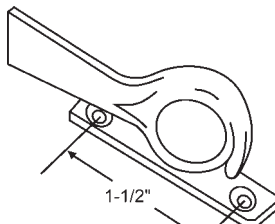

Sweep Height 1/2"

Part #	Finish
50-654	White Bronze

Bronze Casting

Use with 900-9151 Keeper.

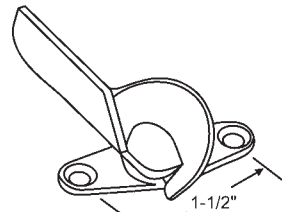

Sweep Height 19/32"

Part #	Finish
50-662	Brite

Zinc Die Cast

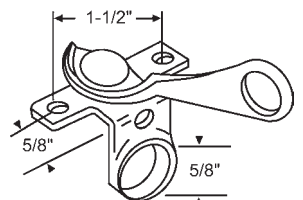

Sweep Height 7/16"

Part #	Finish
50-653	White Bronze

Bronze Casting

Window Replacement Hardware

Sweep Locks & Sash Locks

1-1/2"

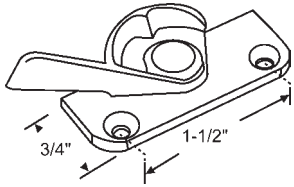

Part #	Finish
900-40	Unfinished

Zinc Die Cast
Ualco

1-17/32"

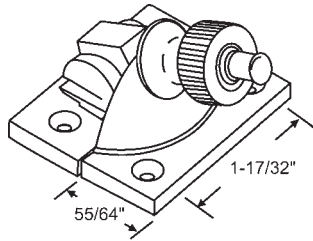

Part #	Finish
50-1096BRS	Polished Brass
50-1096CH	Chrome Plated

Brighton Style Sash Lock and Keeper.
Spring Action. Solid Cast Brass
Mighton

1-5/8"

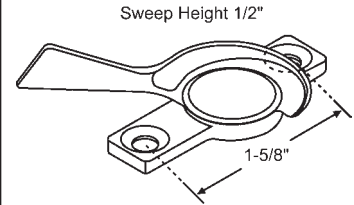

Part #	Finish
50-689	White Bronze

Bronze Casting. Use with 50-690 Keeper

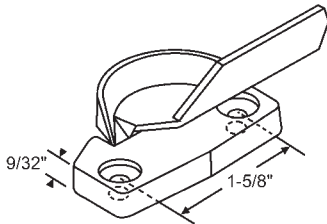

Part #	Hand	Finish
900-10803LH	Shown	Brite
900-10803RH	Opposite	Brite

Zinc Die Cast. Use with 50-800 Keeper.
Nuprime/Seasonall

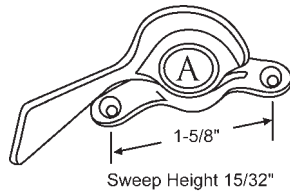

Part #	Finish
50-710	White Bronze

Bronze Casting. Use with 50-709 Keeper.
Alwinseal

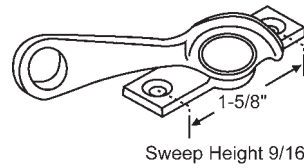

Part #	Finish
900-6706	White Bronze

Bronze Casting

1-21/32"

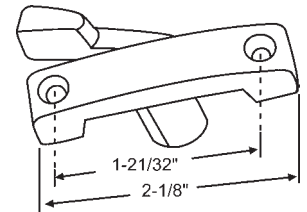

Part #	Finish
50-849	Dark Bronze

Zinc Die Cast

1-3/4"

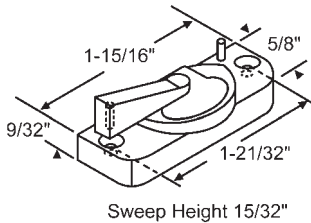

Part #	Finish
50-863	Unfinished

Zinc Die Cast
Amco

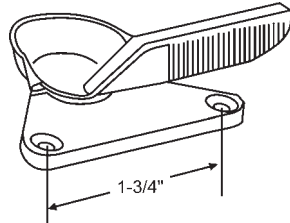

Part #	Hand	Finish
50-612-30R	Shown	Antique Copper
50-612-30L	Opposite	Antique Copper

Zinc Die Cast
Fiberlux/Remington

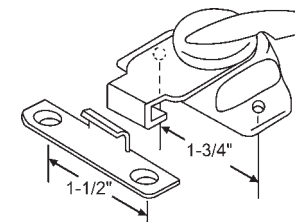

Part #	Finish
50-658A	Chrome Plated
50-658B	Brass Plated

Stamped Steel. Includes Keeper

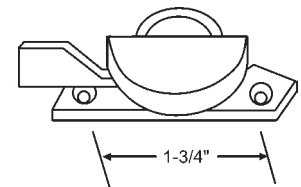

Part #	Finish
50-676	Brite

Zinc Die Cast. Use with 50-643 Keeper.

1-13/16"

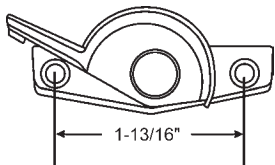

Part #	Finish
50-681	Black

Zinc Die Cast
Croft

1-7/8"

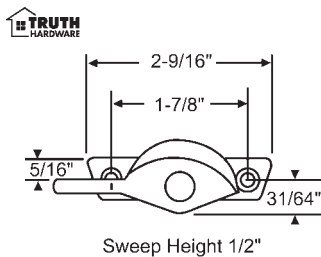

Part #	Finish
50-360-1	Bronze

Low Profile Cam Lock
Zinc Die Cast. Use with Keeper 50-361-1.

Window Replacement Hardware

Sweep Locks & Sash Locks

1-7/8"

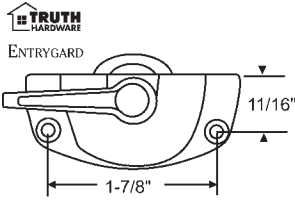

Part #	Finish
50-369-1	Bronze
50-369-3	White
50-369-28	Almond

Zinc Die Cast. Use with Keepers 50-374-Color and 50-372-Color.

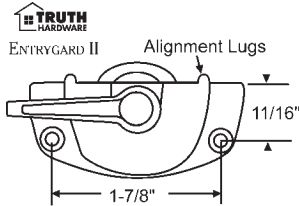

Part #	Finish
50-842-1	Bronze
50-842-3	White
50-842-8	Chestnut Bronze

Zinc Die Cast Use with Keepers 50-379-Color, 50-740-Color, 50-373-Color and 50-372-Color.

1-31/32"

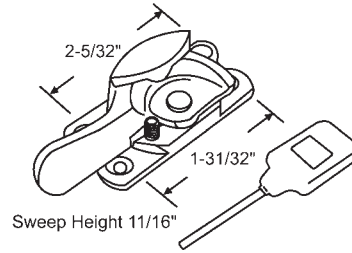

Security Sash Lock and Keeper

Part #	Finish
50-1100BRS	Solid Brass
50-1100CH	Chrome

Solid Cast Brass.

Part #	Description
50-1100SS	Stainless Steel

Mighton

2"

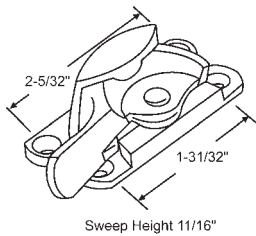

Part #	Finish
50-1099BRS	Solid Brass
50-1099CH	Chrome

Sash Lock and Keeper. Solid Cast Brass

Mighton

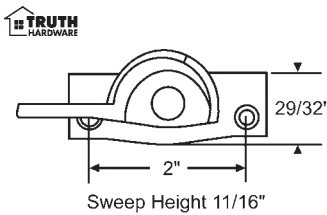

Part #	Finish
50-356-1	Bronze

Zinc Die Cast. Use w/Keeper 50-357-Color or Beveled Keeper 50-358-Color.

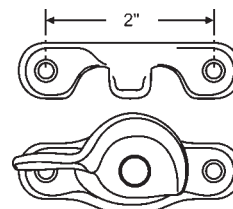

Part #	Finish
50-634A	Zinc Die Cast, Brass Plated
50-748	Solid Brass, Polished Brass

Includes Keeper

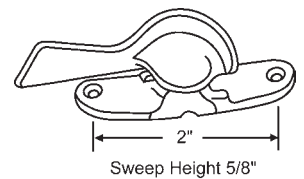

Part #	Finish
50-669	White Bronze

Bronze Casting

2-1/16"

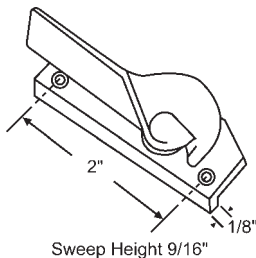

Part #	Finish
900-18881	White

Zinc Die Cast. Sweep Height 9/16"

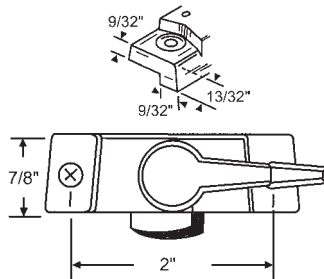

Part #	Finish
50-776-3	White
50-776-30	Antique Copper

Zinc Die Cast

Acro/Slocomb

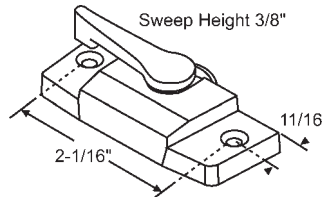

Part #	Finish
50-865B	Black
50-865W	White

Zinc Die Cast. Use with 50-896 Keeper.

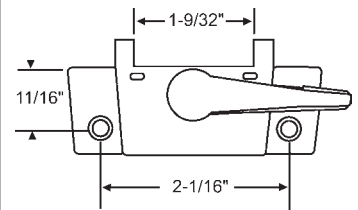

Part #	Finish
50-924-65	Terratone Brown
50-924-47	Bronze

Zinc Die Cast

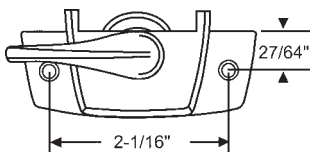

Part #	Finish
50-752W	White

Zinc Die Cast. Use with 50-753W Keeper.

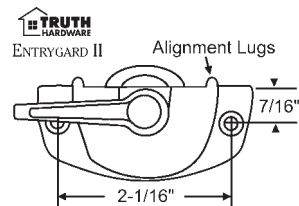

Part #	Finish
50-784-1	Bronze
50-784-3	White
50-784-8	Chestnut Bronze

Zinc Die Cast. Use with Keeper 50-379-Color, 50-372-Color and 50-373-Color.

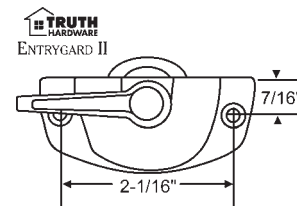

Part #	Finish
50-789-1	Bronze
50-789-3	White
50-789-8	Chestnut Bronze

Zinc Die Cast. Use with Keeper 50-374-Color and 50-372-Color.

Window Replacement Hardware

Sweep Locks & Sash Locks

2-1/16"

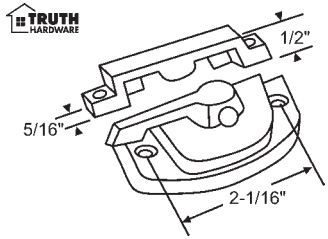

Part #	Finish
50-762	White

Push Button Security Lock
Zinc Die Cast. Includes Keeper

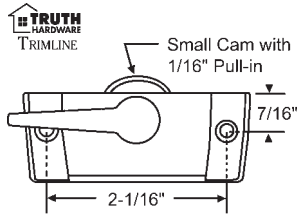

Part #	Finish
50-386-1	Bronze
50-386-3	White

Zinc Die Cast

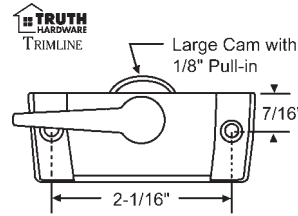

Part #	Finish
50-384-1	Bronze
50-384-2	Gold
50-384-3	White

Zinc Die Cast

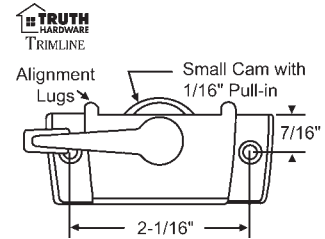

Part #	Finish
50-382-1	Bronze
50-382-3	White
50-382-8	Chestnut Bronze

Zinc Die Cast. Use with 50-392-3 Keeper.

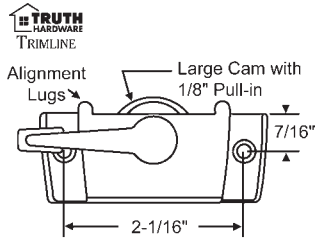

Part #	Finish
50-380-3	White
50-380-6	Clay
50-380-8	Chestnut Bronze
50-380-14	Cocoa Brown

Zinc Die Cast. Use with 50-392 and 50-393 Keepers.

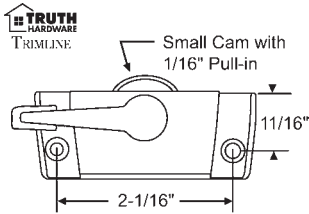

Part #	Finish
50-385-1	Bronze
50-385-3	White

Zinc Die Cast

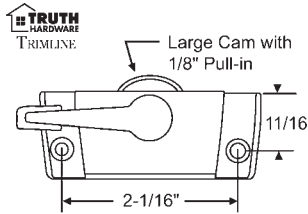

Part #	Finish
50-387-3	White
50-387-5	Polished Brass
50-387-6	Clay

Zinc Die Cast. Use with 50-387K Keeper.

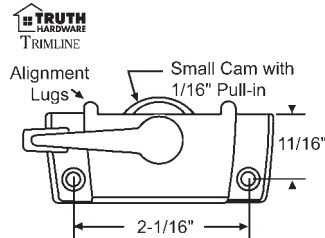

Part #	Finish
50-381-1	Bronze
50-381-3	White
50-381-8	Chestnut Bronze

Zinc Die Cast. Use with 50-392 and 50-393 Keepers.

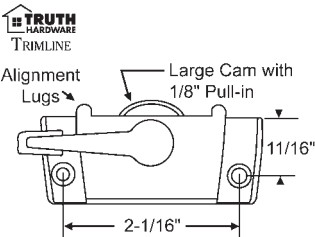

Part #	Finish
50-383-3	White
50-383-4	Coppertone

Zinc Die Cast. Use with 50-392 and 50-393 Keeper.

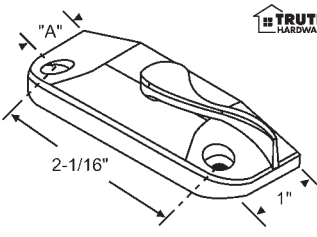

Part #	Finish	"A"
50-939-46	Appliance White	11/16"
50-940-46	Appliance White	7/16"

Zinc Die Cast
Use with 50-1112-46 Keeper.

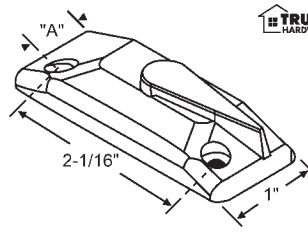

Part #	Finish	"A"
50-937-3	White	7/16"
50-938-46	Appliance White	11/16"

Zinc Die Cast. Use with 50-1109-3 and 50-1112-46 Keeper.

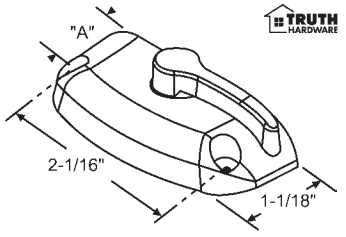

Part #	Finish	"A"
50-941-46	Appliance White	7/16"
50-942-46	Appliance White	11/16"

Zinc Die Cast. Use with 50-1110-46 and 50-1111-46 Keeper.

2-5/32"

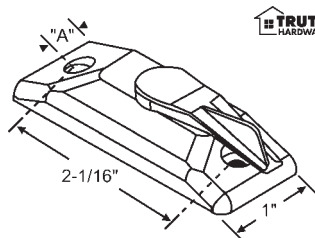

Part #	Finish	"A"
50-943-46	Appliance White	7/16"
50-944-46	Appliance White	11/16"

Zinc Die Cast
Use with 50-1109-46 Keeper.

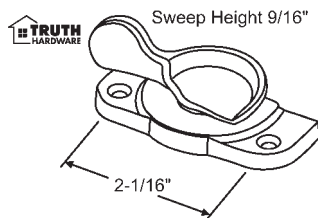

Part #	Finish
50-471-1	Bronze
50-471-5	Polished Brass
50-471-71	Oil-Rubbed Bronze

Restoration Locks. Zinc Die Cast. Use with 50-472-Color Keeper.

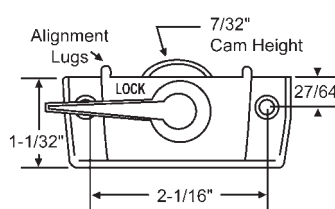

Part #	Finish
50-868	Driftwood

Zinc Die Cast. Use with 50-868K Keeper.

Peachtree

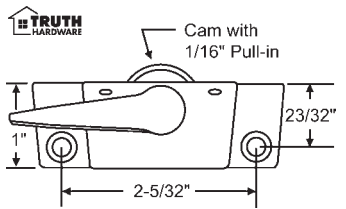

Part #	Finish
50-429-46X	Appliance White

Zinc Die Cast. Use with 900-2122 Keeper.

Window Replacement Hardware

Sweep Locks & Sash Locks

2-5/32"

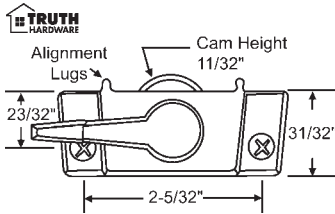

Part #	Finish
900-14379-15	Off White
900-14379-45	Blue White

Zinc Die Cast. Used with 900-18531 Face Mount Keeper.

Fiberlux

2-3/16"

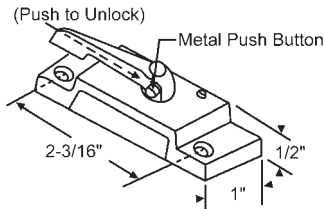

Part #	Finish
50-415-10	Black
50-415-3	White

Zinc Die Cast

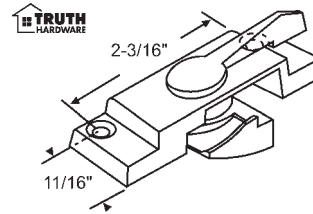

Part #	Finish
50-434-46	Appliance White
50-434-52	Ivory
50-434-54	Brown

Zinc Die Cast. Use with 50-460 and 900-18531 Keeper.

2-7/32"

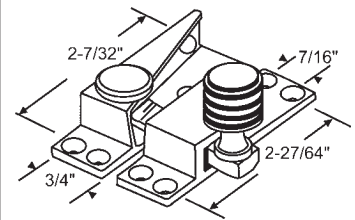

Part #	Finish
50-1098BRS	Brass

Sash Lock and Keeper. Solid Cast Brass

Mighton

2-1/4"

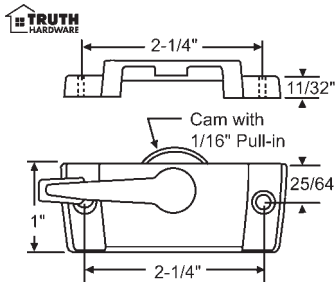

Part #	Finish
50-418-10	Black
50-418-45	Blue White

Zinc Die Cast. Includes Keeper

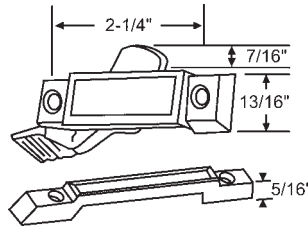

Lock and Keeper

Part #	Finish
50-603A	Chrome
50-603BA	Black
50-603WA	White

Zinc Die Cast

Sweep Lock Only

Part #	Finish
50-603	Chrome
50-603B	Black
50-603W	White
50-603BZ	Bronze

Keeper Only

Part #	Finish
50-602	Chrome
50-602B	Black
50-602W	White
50-602CP	Antique Copper

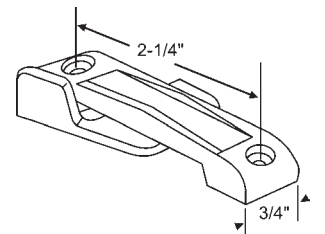

Part #	Finish
50-657B	Black

Zinc Die Cast

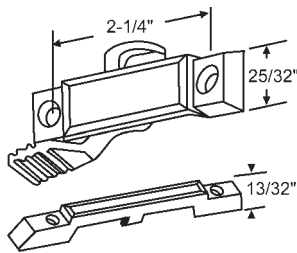

Lock and Keeper

Part #	Finish
50-601A	Chrome
50-601WA	White
50-601BA	Black

Sweep Lock Only

Part #	Finish
50-601-55	Metallic Gold
50-601-8	Dark Bronze

Zinc Die Cast

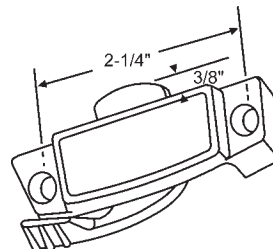

Part #	Finish
50-731B	Black

Zinc Die Cast. Use with 50-602 Keeper.

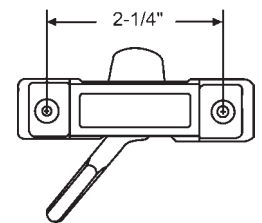

Part #	Finish
900-7903	White Bronze

Bronze Casting

Seasonall

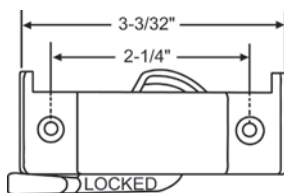

Part #	Finish
900-19656B	Black

Zinc Die Cast. Use with 900-19705 Keeper.

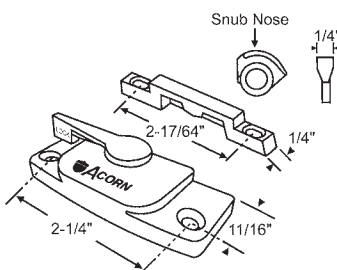

Part #	Finish
50-915	White

Includes Keeper

Acorn

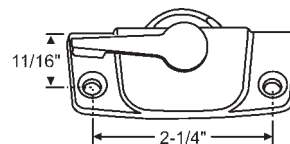

Part #	Finish
50-970B	Black

Zinc Die Cast. Sweep Height 5/16". Use with 50-970KB Keeper.

Acorn

Window Replacement Hardware

Sweep Locks & Sash Locks

2-1/4"

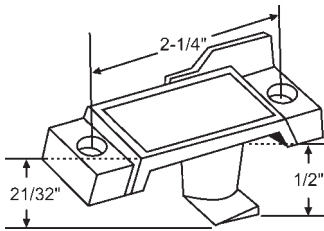

Part #	Finish
50-765	White
50-765B	Black
50-764-8	Chestnut Bronze

Use with 50-602 Keeper.

Acom

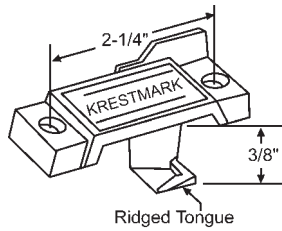

Part #	Finish
900-10798KB	Black

Zinc Die Cast
Krestmark

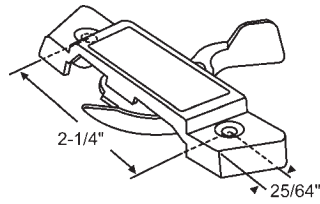

Part #	Hand	Finish
900-19112LH	Shown	Black
900-19112RH	Opposite	Black

Zinc Die Cast
Rusco

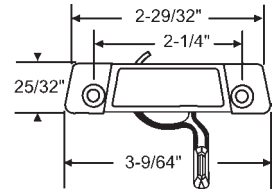

Part #	Hand	Finish
50-971X-3RH	Shown	White
50-971X-3LH	Opposite	White
50-971X-10RH	Shown	Black
50-971X-10LH	Opposite	Black

Zinc Die Cast
MI Home Products

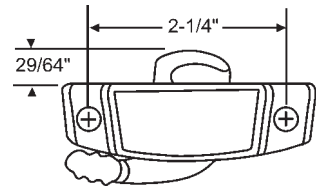

Part #	Finish
900-11005B	Black

Zinc Die Cast. Use with 900-14381 Keeper.

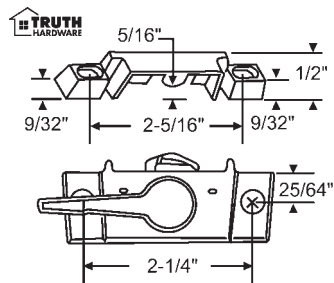

Part #	Finish
50-827-46	White
50-827-70	Dark Brown

Zinc Die Cast. Includes Keeper

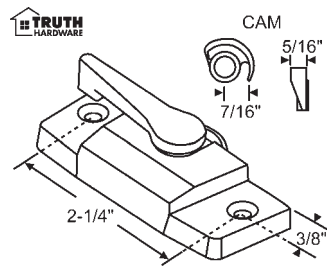

Part #	Finish
900-19228W	White
900-19228BG	Beige

Zinc Die Cast. Use with 900-20118 Face Mount Keeper.

Traco/Rollyson

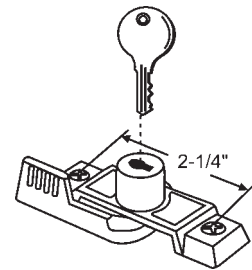

Part #	Finish	Tongue Projection
900-11000B	Black	.429
50-816W	White	.335

Zinc Die Cast. Use with 50-602 and 50-817 Keepers.

2-3/8"

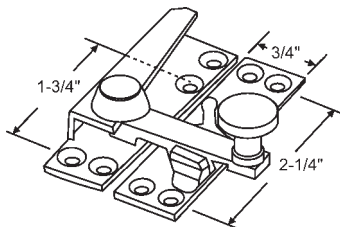

Part #	Finish
50-1097BRS	Solid Brass
50-1097CH	Chrome

Solid Cast Brass

Mighton

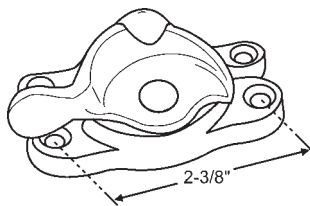

Part #	Finish
50-440	Polished Brass

Lacquered

2-9/16"

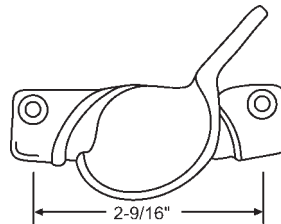

Sweep Height 1"

Part #	Finish
900-7858	Copper

Bronze Casting
Use with 900-7859 Keeper.

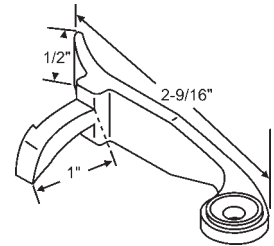

Part #	Finish
900-11288	Chrome

Zinc Die Cast
Modulume

2-5/8"

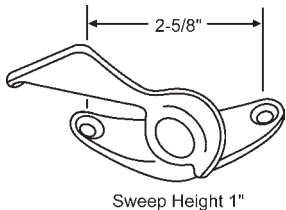

Sweep Height 1"

Part #	Finish
50-723	White Bronze

Bronze Casting

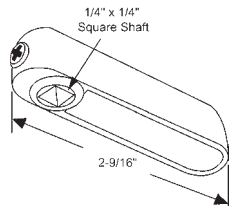

Part #	Finish
900-21337-BG	Driftwood

Plastic Lever Latch
Peachtree

Window Replacement Hardware

Stamped Steel Face Mounted Window Keepers

Stamped steel keepers in order by mounting hole distance and height.

Single Hole

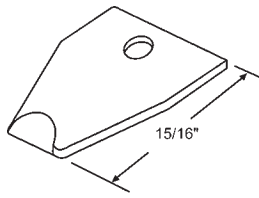

Part #	Finish
50-712	Stamped Steel

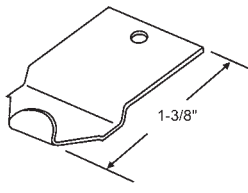

Part #	Finish
50-692	Stamped Steel

7/16"

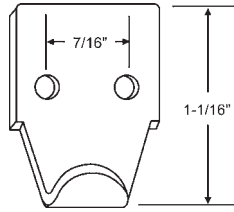

Part #	Finish
50-661	Stamped Steel

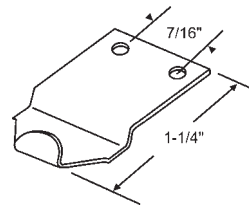

Part #	Finish
50-691	Stamped Steel

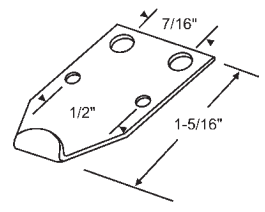

Part #	Finish
50-694	Stamped Steel

15/32"

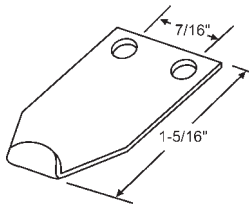

Part #	Finish
50-697	Stamped Steel

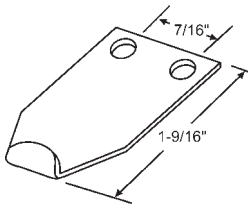

Part #	Finish
900-9744	Stamped Steel
900-9744W	White

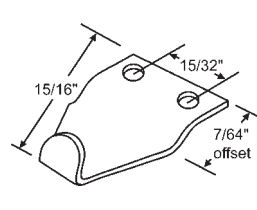

Part #	Finish
50-700	Stamped Steel

1/2"

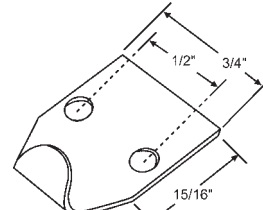

Part #	Finish
900-8359	Stamped Steel

5/8"

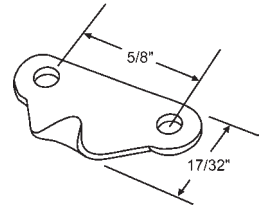

Part #	Finish
50-663	Stamped Steel

Binnings

Hung & Sliding Face Mounted Window Keepers

Face mounted keepers in order by mounting hole distance and height.

1-1/4"

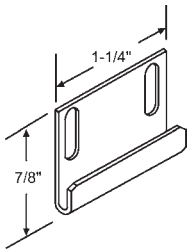

Part #	Finish
50-790	Stamped Steel

Single Hole

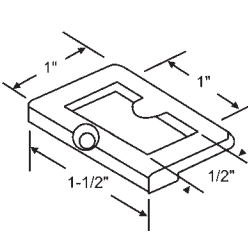

Part #	Finish
50-650	Chrome

Zinc Die Cast

7/16"

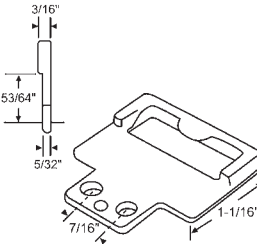

Part #	Finish
900-18531BG	Almond
900-18531BK	Black
900-18531-45	Blue White

Zinc Die Cast

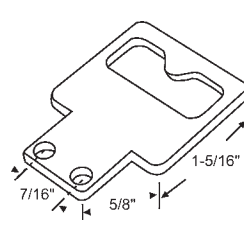

Part #	Finish
900-18880	Antique Copper

Zinc Die Cast

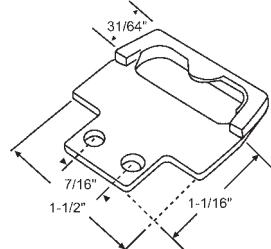

Part #	Finish
900-18552-45	Blue White

Zinc Die Cast
Fiberlux

1/2"

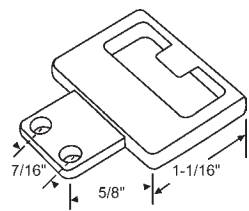

Part #	Finish
50-775-3	White
50-775-30	Antique Copper
50-777-12	Dayton Brown

Zinc Die Cast

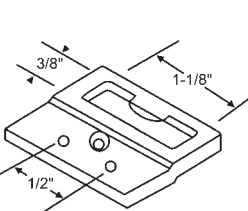

Part #	Finish
50-696	Chrome

Zinc Die Cast

5/8"

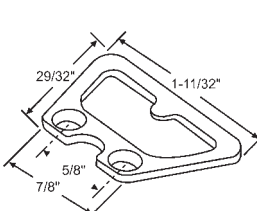

Part #	Finish
900-9920	White Bronze

Bronze Casting

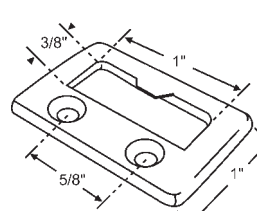

Part #	Finish
50-643	Brille

Zinc Die Cast

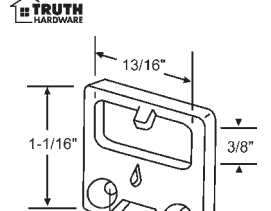

Part #	Finish
50-609WB	White Bronze

Norandex

Window Replacement Hardware

Hung & Sliding Face Mounted Window Keepers

11/16"

3/4"

25/32"

7/8"

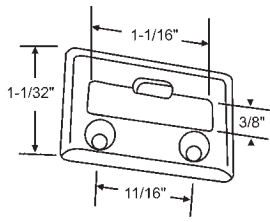

Part #	Finish
50-642	Brite

Zinc Die Cast

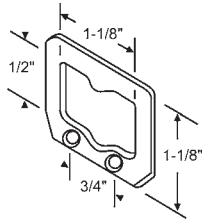

Part #	Finish
50-709	White Bronze

Bronze Casting

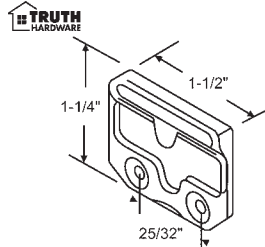

Part #	Finish
50-733K	Brite

Zinc Die Cast

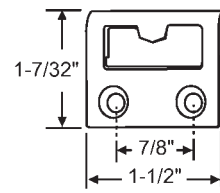

Part #	Finish
50-970KB	Black

Zinc Die Cast

Acom

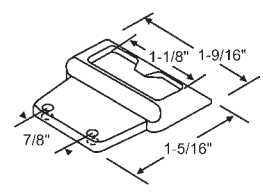

Part #	Finish
50-800	Satin Aluminum

Zinc Die Cast

Better Bolt

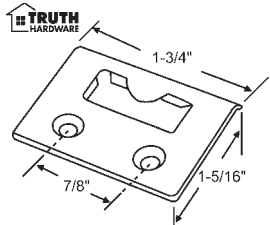

Part #	Finish
50-914-1	Bronze
50-914-9	Beige

Zinc Die Cast

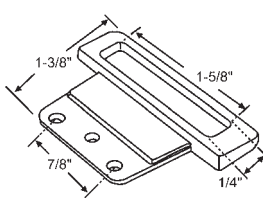

Part #	Finish
50-647	Chrome

Zinc Die Cast

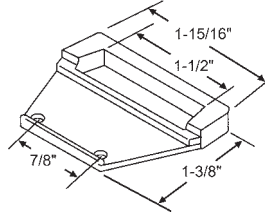

Part #	Finish
900-20101	Chrome

Zinc Die Cast

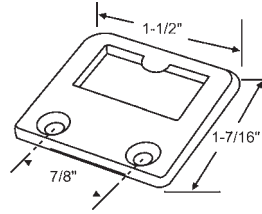

Part #	Finish
50-1004	Brite

Zinc Die Cast

Pan Am

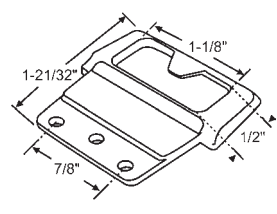

Part #	Finish
50-646	Chrome

Zinc Die Cast

Seasonall

1"

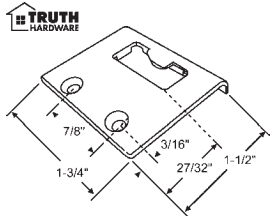

Part #	Finish
50-805W	White

Zinc Die Cast

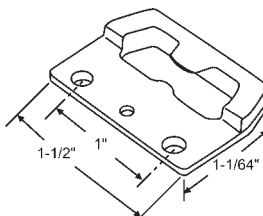

Part #	Finish
50-753W	White

Zinc Die Cast

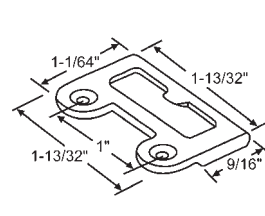

Part #	Finish
900-9929	White Bronze

Bronze Casting

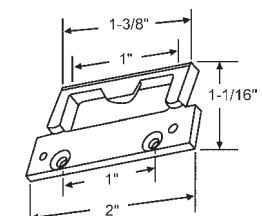

Part #	Finish
50-804BG	Beige
50-804WH	White

Zinc Die Cast

Rollyson

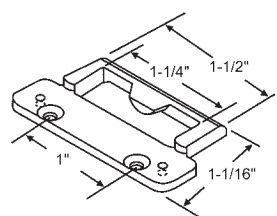

Part #	Finish
900-20118	White
900-20118BG	Beige

Zinc Die Cast

Rollyson

1-1/4"

1-7/16"

2-1/16"

2-1/4"

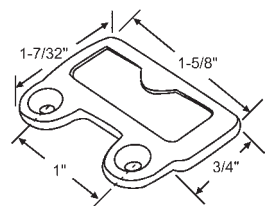

Part #	Finish
900-13581	White Bronze

Bronze Casting

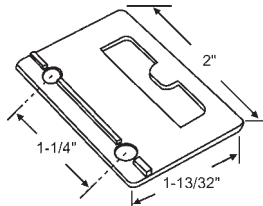

Part #	Finish
50-1001W	White
50-1001B	Black

Zinc Die Cast

MI Home Products

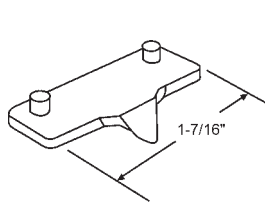

Part #	Finish
50-623	Unfinished

Zinc Die Cast

Air Control

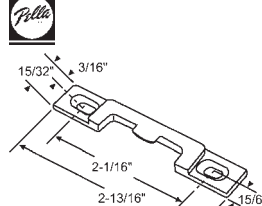

Part #	Finish
50-489-3	White

Vinyl

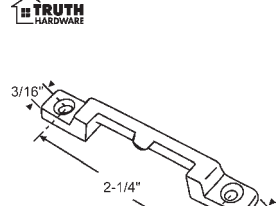

Part #	Finish
50-749	White

Zinc Die Cast

Window Replacement Hardware

Face Mounted Keeper

Hung & Sliding Top Mounted Window Keepers

Top mounted keepers in order by mounting hole distance and height.

2-5/16"

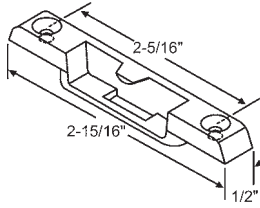

Part #	Finish
50-895	White

Plastic
Metal Industries

1/2"

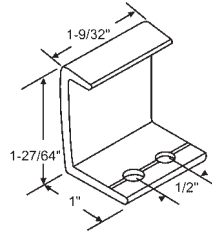

Part #	Finish
900-18719	Brown

Zinc Die Cast
Traco

3/4"

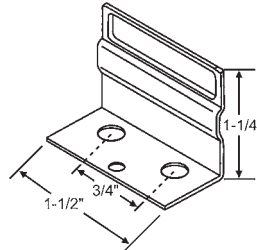

Part #	Finish
900-8728	Aluminum

Thermalgard

1"

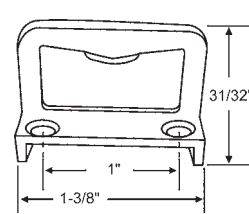

Part #	Finish
50-699	Unfinished

Zinc Die Cast

1-1/8"

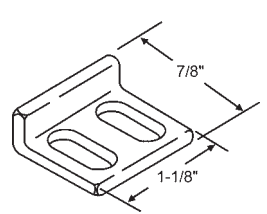

Part #	Finish
50-736	White Bronze

Bronze Casting
SWS

1-11/32"

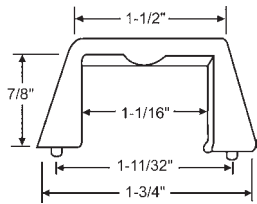

Part #	Finish
50-639	Chrome

Zinc Die Cast
Alenco

1-3/8"

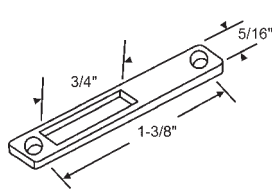

Part #	Finish
50-716	Chrome

Zinc Die Cast
Crossly

1-5/8"

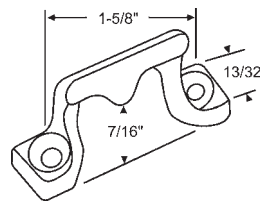

Part #	Finish
50-690	White Bronze

Bronze Casting

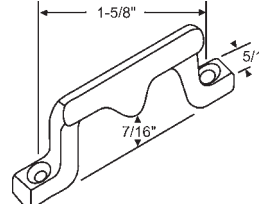

Part #	Finish
900-12561	White Bronze

Bronze Casting

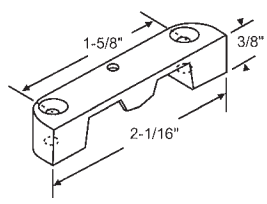

Part #	Finish
50-801K	Bright Brass

Zinc Die Cast

1-7/8"

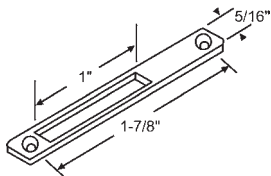

Part #	Finish
50-611	Chrome

Zinc Die Cast
Portolume

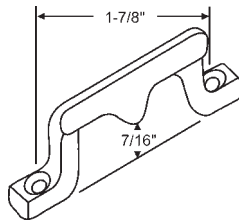

Part #	Finish
50-724	White Bronze

Bronze Casting

1-51/64"

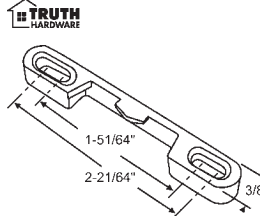

Part #	Finish
50-968-46	White

Zinc Die Cast

1-27/32"

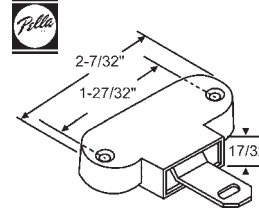

Part #	Finish
50-832	Beige

Sash Catch
Plastic with Steel Tongue

1-15/16"

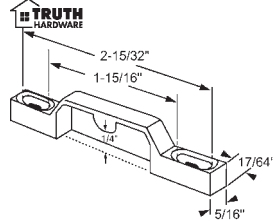

Part #	Finish
900-21122	White
900-21122-65	Brown
900-21122BG	Beige

Zinc Die Cast

2"

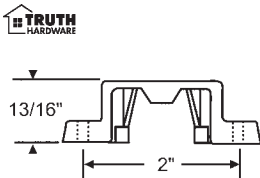

Part #	Finish
50-357-3	White
50-357-1	Bronze

2-1/16"

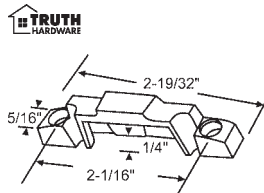

Part #	Finish
50-373-3	White
50-373-5	Bright Brass

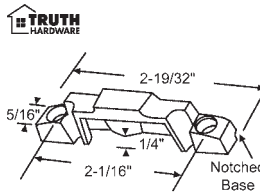

Part #	Finish
50-372-1	Bronze
50-372-3	White
50-372-5	Bright Brass
50-372-6	Clay
50-372-9	Beige

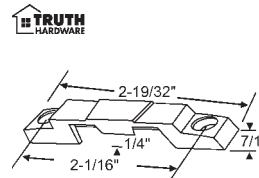

Part #	Finish
50-374-1	Bronze
50-374-3	White
50-374-2	Gold

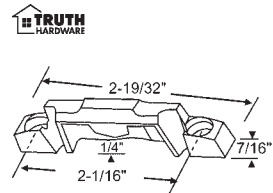

Part #	Finish
50-379-1	Bronze
50-379-3	White
50-379-8	Chestnut Bronze

Window Replacement Hardware

Hung & Sliding Top Mounted Window Keepers

2-1/16"

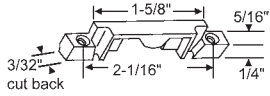

Part #	Finish
50-393-3	White
50-393-9	Beige
50-393-4	Coppertone
50-393-8	Chestnut Bronze

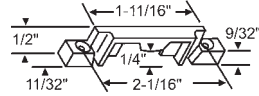

Part #	Finish
50-855	Bronze
50-855BE	Beige
50-855W	White

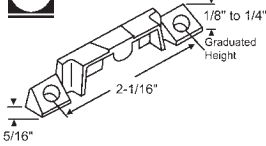

Part #	Finish
50-920-35	Champagne
50-920-3	White

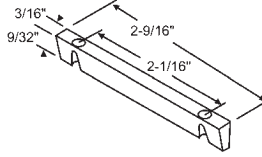

Part #	Finish
900-20103W	White
900-20103B	Black
900-20103BE	Beige

Plastic Shim

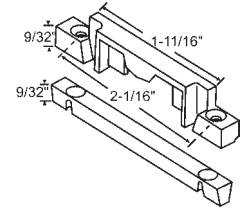

Part #	Finish
900-20056	Beige
900-20056W	White

With Shim

2-1/8"

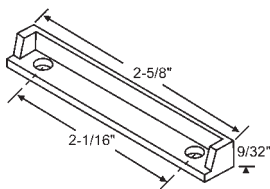

Part #	Finish
900-20045W	White
900-20045B	Black

Keeper Shim
Better Bilt

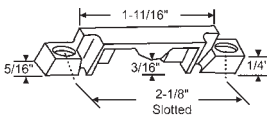

Part #	Finish
50-392-3	White
50-392-1	Bronze
50-392-14	Cocoa Brown
50-392-8	Chestnut Bronze
50-392-6	Clay

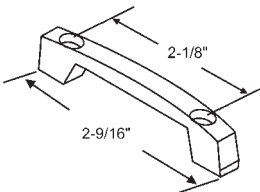

Part #	Finish
900-14377KB	Black

Syn-Tech

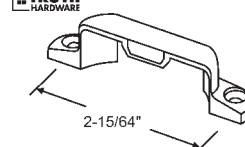

Part #	Finish
50-472-1	Bronze
50-472-5	Polished Brass
50-472-71	Oil-Rubbed Bronze
50-472-72	Brushed Chrome

Keeper. Zinc Die Cast.
Screws not Included.

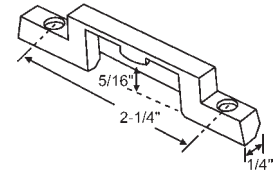

Part #	Finish
900-21121	Black

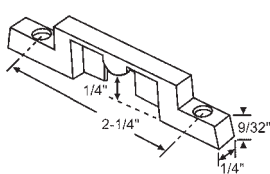

Part #	Finish
900-21375	White

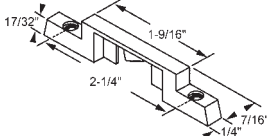

Part #	Finish
900-19229BG	Beige
900-19229BL	Black
900-19229AB	Antique Brass
900-19229BZ	Bronze

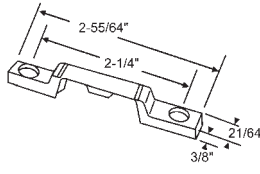

Part #	Finish
900-18601	Pewter

Traco

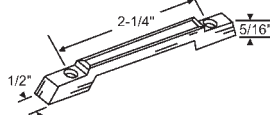

Part #	Finish
50-602CP	Antique Copper

2-3/8"

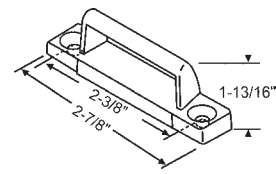

Part #	Finish
50-802	Satin Aluminum

Nu-Prime

2-7/16"

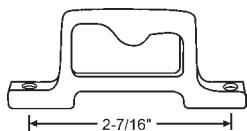

Part #	Finish
900-7859	Bronze

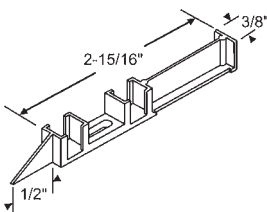

Part #	Finish
900-9562	Dichromate

Acorn

Spring type latches in order by mounting hole distance and length.

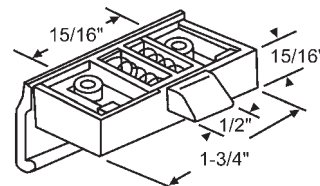

50-600A
Plastic

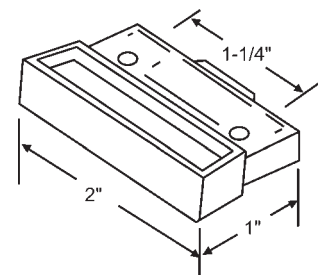

50-688
Nylon

Window Replacement Hardware

Spring Type Slider Latches

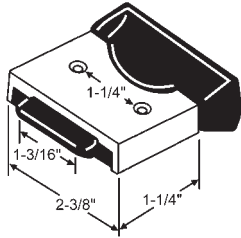

Part #	Finish
50-648A	Chrome and Black
50-648BEA	Chrome and Beige
50-648WHA	Chrome and White

Used with 50-647 Keeper.

Seasonall

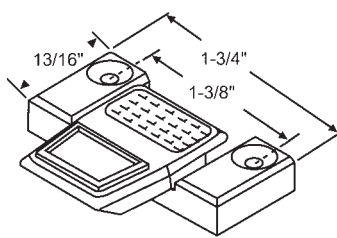

900-9950
Die Cast

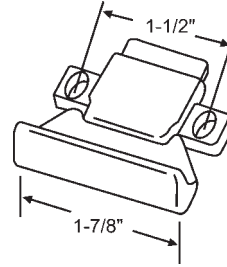

Part #	Finish
50-628A	Aluminum
50-628WA	White Aluminum

50-730
Black Plastic

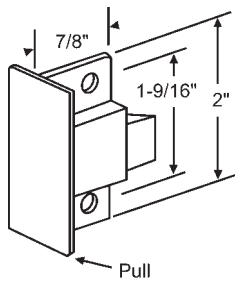
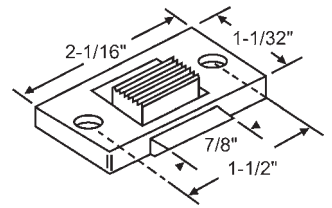

50-1007
Black
Die Cast

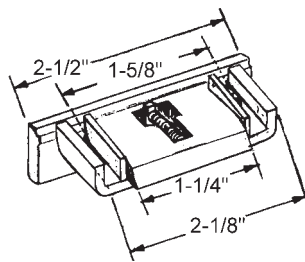

900-9061
Black
Die Cast

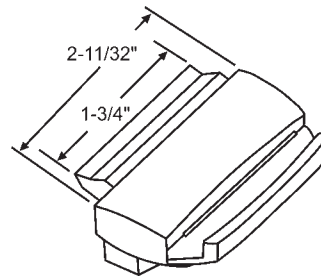

Part #	Finish
900-26	Bronze Lacquer
900-25	Chrome

Aluminum
Crossly

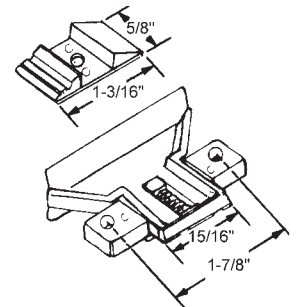

900-8878
Black Aluminum

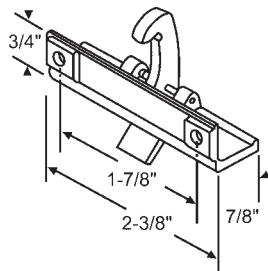

50-735
White Bronze. Used with Keeper 50-736

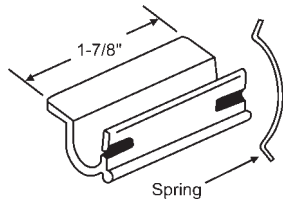

50-633
Nylon

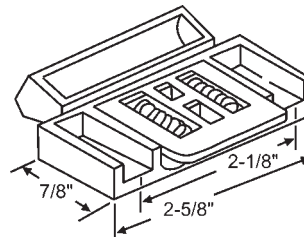

50-660
Nylon

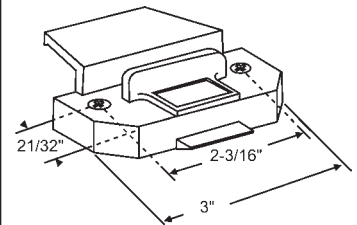

900-6734B
Die Cast with Tabs on Bottom. Black
Capitol

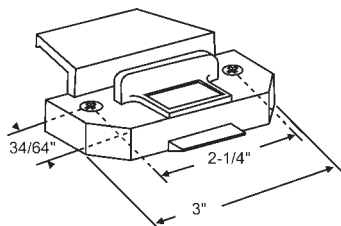

50-1203
Die Cast
Chrome Plated

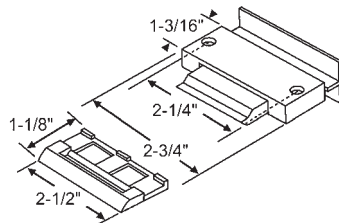

900-11566A
Black Metal

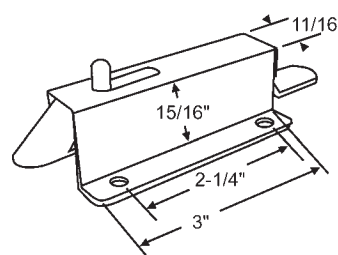

50-919
Aluminum

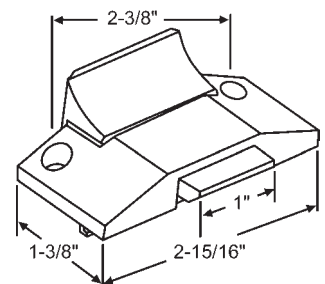

50-725
Black Aluminum

Window Replacement Hardware

Spring Type Slider Latches

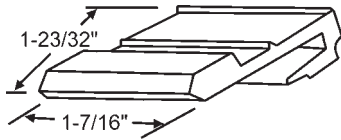

900-7972

Black. Use with 50-725 Latch.

Capitol

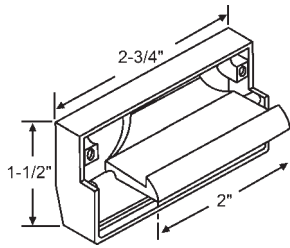

900-11470

Plastic Handle with Metal Housing
Black

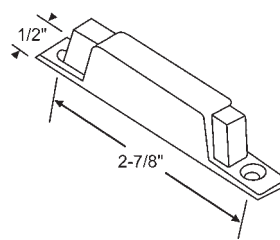

50-615A

Nylon

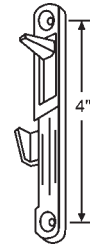

Part #	Hand
52-640	Shown
52-641	Opposite

Slider Lock

Sash Lift

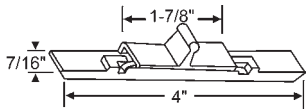

900-9563

Black Plastic

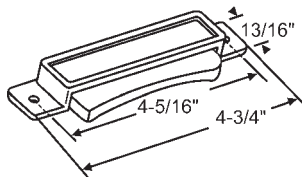

50-848

Black Aluminum

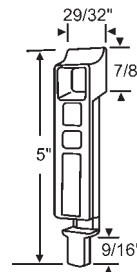

900-8997

Black Metal

Acorn

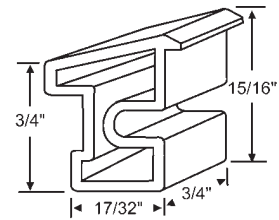

52-7000

Black, Plastic

Acorn

Extruded Sash Handles & Lifts

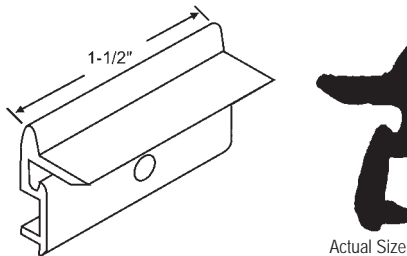

Part #	Finish
900-8615	Black

Glazing Clip, Nylon

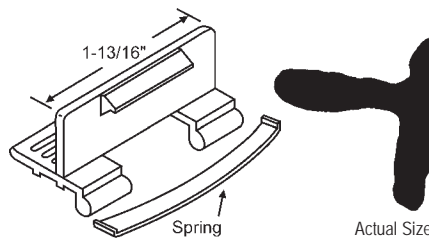

Part #	Finish
50-729	Black

Aluminum
Nu-Aire

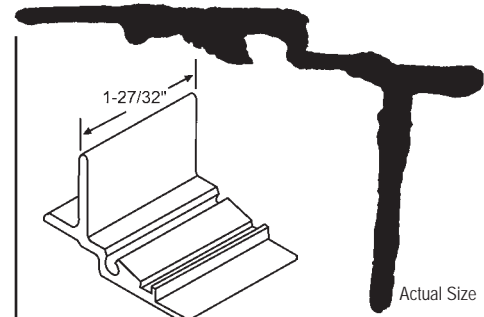

Part #	Finish
900-10875	Mill

Aluminum

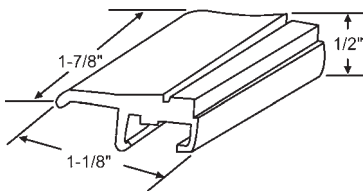

Part #	Finish
900-10495XM	Mill
900-10495XW	White

Aluminum

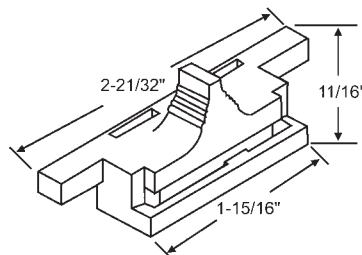

Part #	Finish
900-5484A	White

Plastic Slider Lock with Spring

Crossly

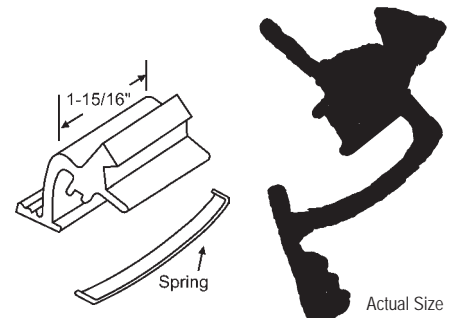

Part #	Finish
50-713	Mill

Aluminum

Window Replacement Hardware

Extruded Sash Handles & Lifts

1-15/16"

Spring

Actual Size

Part #	Finish
50-617A	Bronze

Aluminum

1-15/16"

1-3/4"

Part #	Finish
50-626	Mill

Aluminum

Keller

2"

9/16"

1-1/4"

Part #	Finish
50-751A	Earth Brown
50-751WA	White

Aluminum

Capitol

1-31/32"

Actual Size

Part #	Finish
50-708	Black
50-708W	White

Plastic

2"

3/4"

Actual Size

Part #	Finish
50-629A	Mill

Aluminum

Crossley

2"

Spring

Actual Size

Part #	Finish
50-778W	White

Aluminum

2-3/16"

Actual Size

Part #	Finish
900-9560BA	Brown

Aluminum with Spring

Acorn

2-3/16"

Spring

Actual Size

Part #	Finish
900-9559	White
900-9559A	Almond
900-9559B	Bronze
900-9559TN	Tan

Aluminum

2-7/32"

Spring

Actual Size

Part #	Finish
50-706	Mill

Aluminum

2-1/2"

Part #	Finish
50-707	Black

Plastic

2-1/2"

Actual Size

Part #	Finish
900-10642	Brown
900-10642W	White

Aluminum

2-17/32"

2-15/16"

Actual Size

Part #	Finish
900-11565	Bronze

Aluminum

Window Replacement Hardware

Extruded Sash Handles & Lifts

2-5/8"

Spring

Actual Size

Part #	Finish
50-768WH	White
50-768	Black

Plastic

2-5/8"

Actual Size

Part #	Finish
900-11342BZ	Bronze

Aluminum

2-5/8"

Part #	Finish
900-13330	Black
900-13330BZ	Bronze

Aluminum

Howard

Actual Size

2-15/16"

Part #	Finish
50-793W	White
50-793BR	Bronze

Aluminum

3"

1-21/32"

1/2"

Spring

Actual Size

Part #	Finish
900-20772	Mill

Aluminum

Spring Only: 900-12257

3"

9/16"

5/8"

Actual Size

Part #	Finish
900-16656W	White
900-16656B	Black

Aluminum

3-5/32"

Actual Size

Part #	Finish
900-1088	Black

Plastic

11/16"

3-1/2"

Actual Size

Part #	Finish
50-622	White

Aluminum

Slider Latch Plate

3-15/16"

Actual Size

Part #	Finish
900-21544W	White

Aluminum

5"

Actual Size

Part #	Finish
900-1084	Anodized Aluminum

Aluminum

5/16"

3-1/4"

3-3/4"

7/8"

Part #	Finish
50-873W	White
50-873BZ	Bronze

Plastic

2-3/16"

2-1/4"

2-27/32"

Part #	Finish
50-949WH	White
50-949BG	Beige

Plastic

Window Replacement Hardware

One Hole Cam Handles

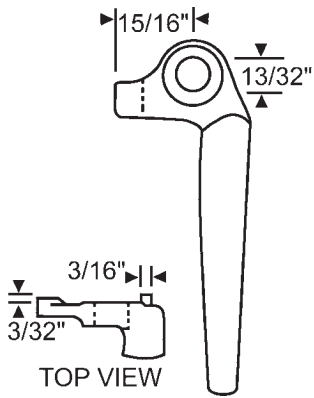

Part #	Hand	Finish
32-208	Shown	Dark Bronze
32-207	Opposite	Dark Bronze

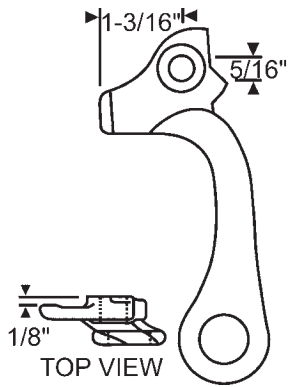

Part #	Finish
32-238	Copper
Water Rolled Finish	

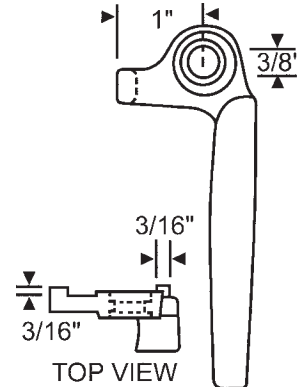

Part #	Hand	Finish
32-254	Shown	Dark Brown
32-255	Opposite	Dark Brown

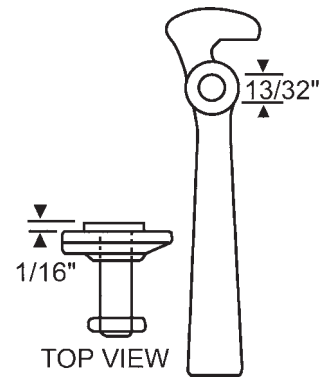

Part #	Finish
32-222	Aluminum

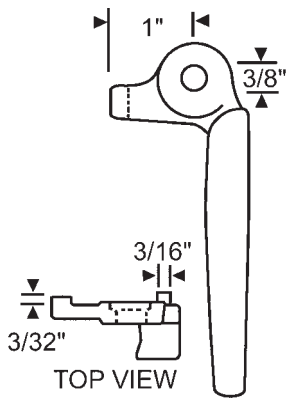

Part #	Finish
32-223	Light Bronze

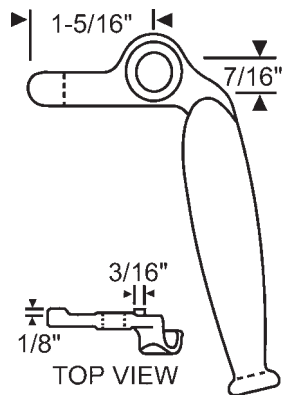

Part #	Hand	Finish
32-230	Shown	Dark Bronze
32-231	Opposite	Dark Bronze

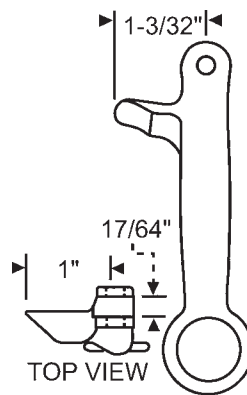

Part #	Finish
32-232	Dark Bronze

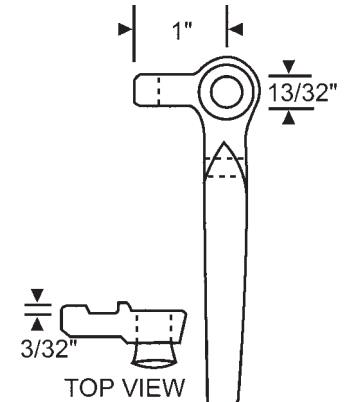

Part #	Hand	Finish
32-236	Shown	Dark Bronze
32-237	Opposite	Dark Bronze

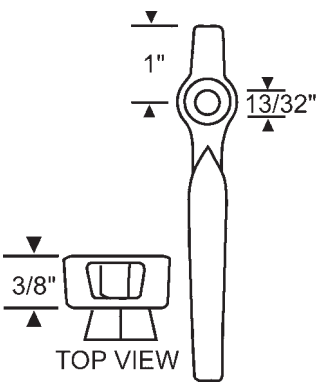

Part #	Finish
32-239	Dark Bronze

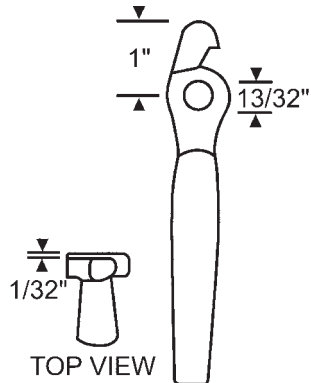

Part #	Finish
32-240	Dark Bronze

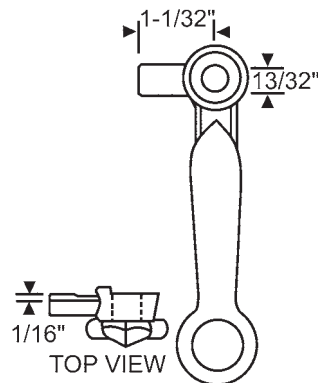

Part #	Hand	Finish
32-272	Shown	Aluminum
32-214	Opposite	Aluminum

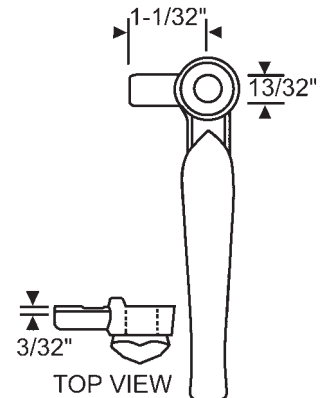

Part #	Hand	Finish
32-247	Shown	Dark Bronze
32-248	Opposite	Dark Bronze

Window Replacement Hardware

One Hole Cam Handles

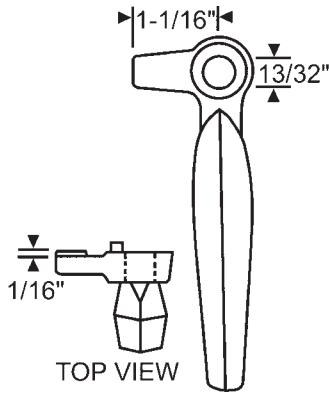

Part #	Hand	Finish
32-249	Shown	Copper
32-250	Opposite	Copper

Water Rolled Finish

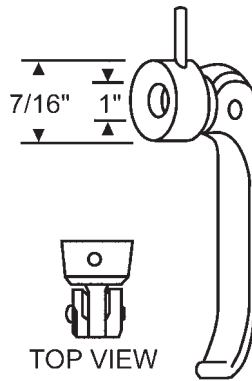

Part #	Finish
32-288	Light Bronze
32-288A	Aluminum

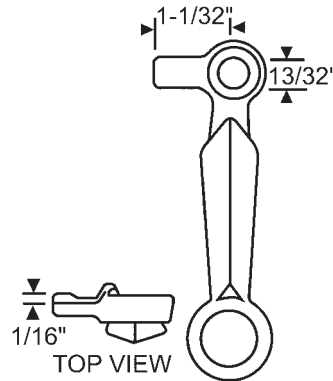

Part #	Finish
32-215	Dark Bronze

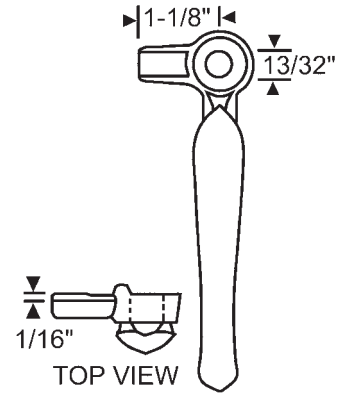

Part #	Hand	Finish
32-219	Shown	Bronze
32-217	Opposite	Bronze

Mounting Hardware for Cam Handles

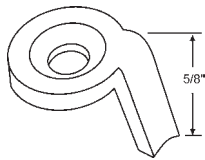

Part #	Finish
32-204	Dark Bronze
32-204A	Aluminum

Clevis

32-204 and 20-022
Use on: 32-207, 32-208, 32-215, 32-236, 32-237, 32-239, 32-240, 32-247, 32-248, 32-273

32-204A and 20-022A
Use on: 32-214, 32-216, 32-217, 32-218, 32-219, 32-222, 32-272

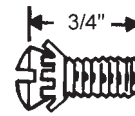

Part #	Finish
20-022	Dark Bronze
20-022A	Aluminum

Clevis Screw with Lock Washer

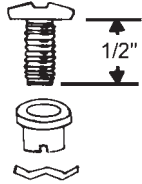

20-027
Dark Bronze Finish
Use on 32-254 and 32-255

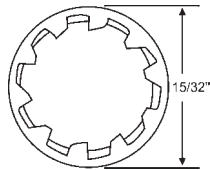

900-9452
Clevis Lock Washer
Use on 32-230 and 32-231



900-7976
Clevis, Dark Bronze
Use on 32-230 and 32-231

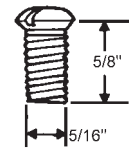

900-7977
Clevis Screw, Dark Bronze
Use on 32-230 and 32-231

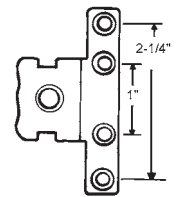

900-7979
Mounting Bracket, Dark Bronze
Use on 32-230 and 32-231

Two Hole Cam Handles



Part #	Hand	Finish
32-433LH	Shown	Black
32-433RH	Opposite	Black

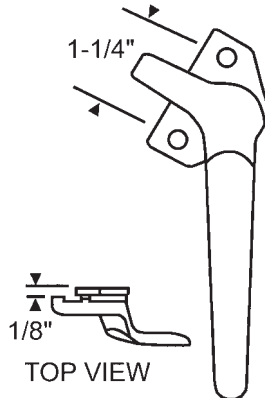

Part #	Hand	Finish
32-242	Shown	Dark Bronze
32-243	Opposite	Dark Bronze

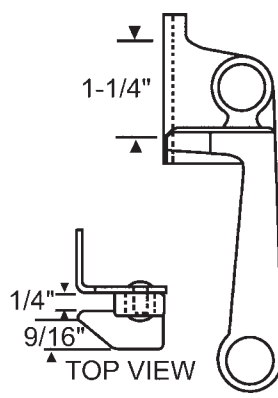

Part #	Finish
32-206	Copper

Water Rolled Finish

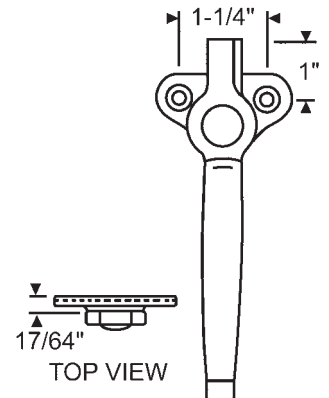

Part #	Finish
32-235	Dark Bronze

Use Screw 20-030

Window Replacement Hardware

Two Hole Cam Handles

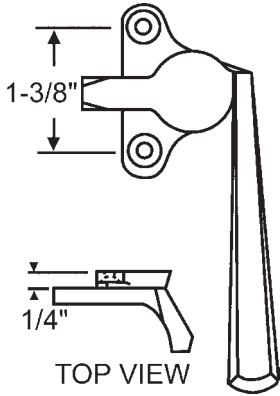

Part #	Hand	Finish
32-295	Shown	Light Bronze
32-294	Opposite	Light Bronze
32-295A	Shown	Aluminum
32-294A	Opposite	Aluminum

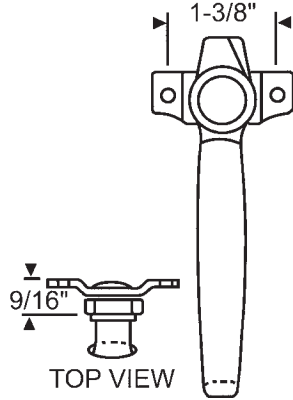

Part #	Finish
32-225	Dark Bronze

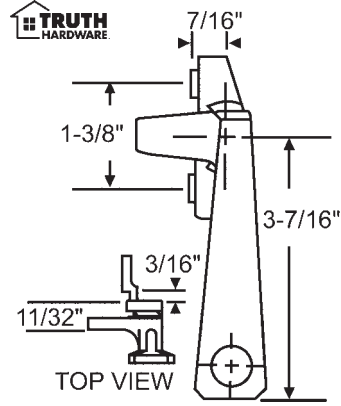

Part #	Finish
32-317-1	Bronze
32-317-8	Chestnut Bronze
32-317-10	Black
32-317-13	Brushed Copper Nickel

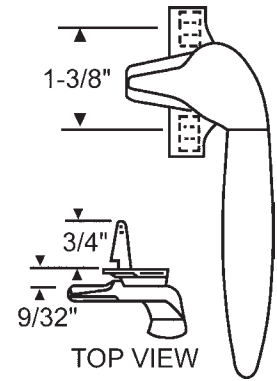

Part #	Finish
32-258	White Bronze

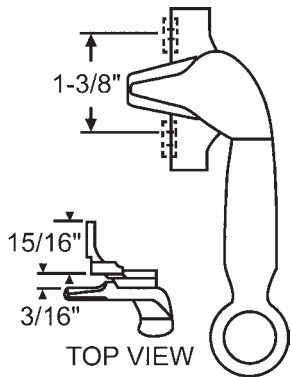

Part #	Finish
32-259	White Bronze

Pole Hole

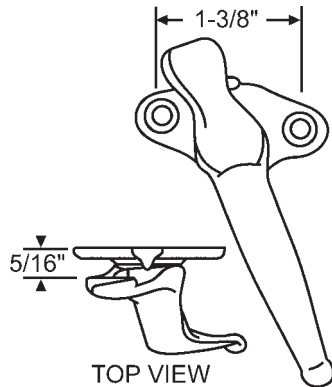

Part #	Finish
32-279	Dark Bronze

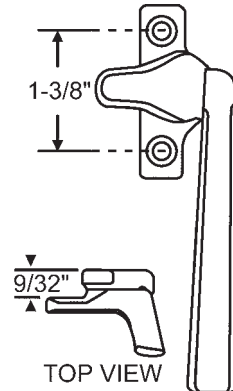

Part #	Hand	Finish
32-301	Shown	White Bronze
32-300	Opposite	White Bronze

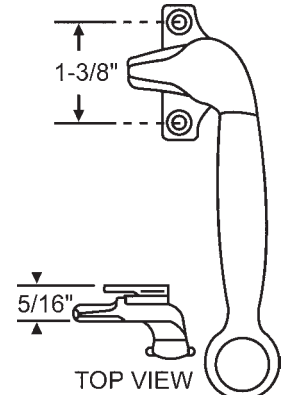

Part #	Hand	Finish
32-308	Shown	White Bronze
32-307	Opposite	White Bronze
32-307MB	Opposite	Medium Bronze

Pole Hole

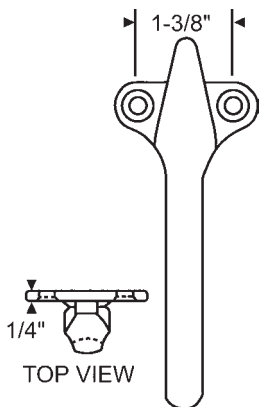

Part #	Finish
32-211	Satin Bronze

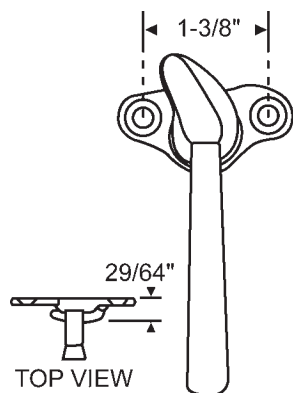

Part #	Finish
32-203	Dark Bronze

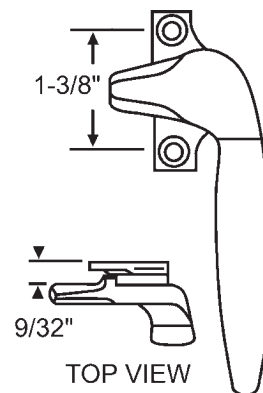

Part #	Hand	Finish
32-221	Shown	White Bronze
32-221DBZ	Shown	Dark Bronze
32-220	Opposite	White Bronze
32-220DBZ	Opposite	Dark Bronze

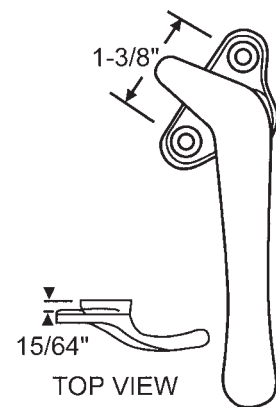

Part #	Hand	Finish
32-263	Shown	Water Rolled Copper
32-241	Opposite	Water Rolled Copper

Window Replacement Hardware

Two Hole Cam Handles

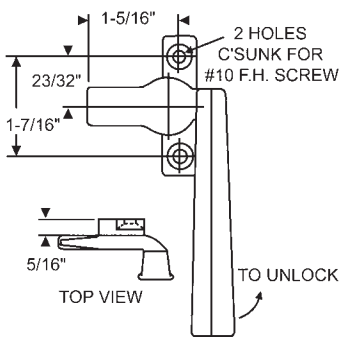

Part #	Hand	Finish
900-8959RH	Shown	White Bronze
900-8959LH	Opposite	White Bronze
900-8959RMB	Shown	Medium Bronze

Use with 900-9132 Keeper

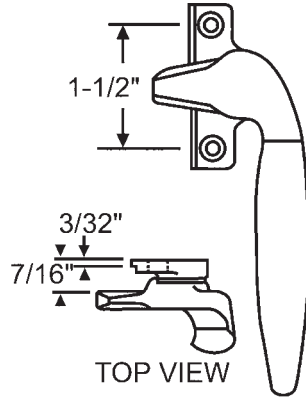

Part #	Hand	Finish
32-252	Shown	Dark Bronze
32-253	Opposite	Dark Bronze

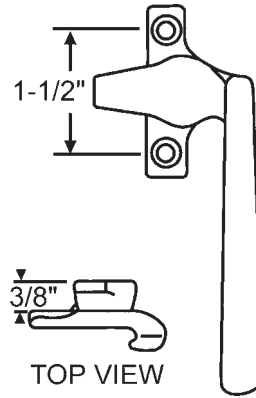

Part #	Hand	Finish
32-257	Shown	White Bronze
32-257LH	Opposite	White Bronze

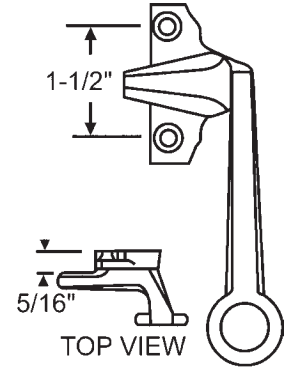

Part #	Finish
32-270	White Bronze

Pole Hole
Ware

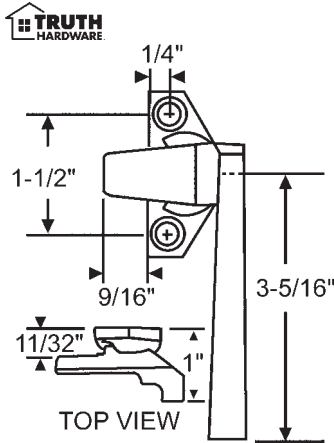

Part #	Hand	Finish
32-311-1	Shown	Bronze
32-311-3	Shown	White
32-311-7	Shown	Aluminum
32-311-8	Shown	Chestnut Bronze
32-311-10	Shown	Black
32-311-11	Shown	Red
32-311-12	Shown	Medium Bronze
32-310-1	Opposite	Bronze
32-310-3	Opposite	White
32-310-7	Opposite	Aluminum
32-310-8	Opposite	Chestnut Bronze
32-310-10	Opposite	Black
32-310-11	Opposite	Red
32-310-12	Opposite	Medium Bronze

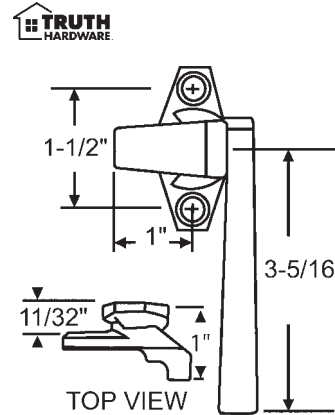

Part #	Hand	Finish
32-313-1	Shown	Bronze
32-313-3	Shown	White
32-313-7	Shown	Aluminum
32-313-12	Shown	Medium Bronze
32-312-1	Opposite	Bronze
32-312-3	Opposite	White
32-312-7	Opposite	Aluminum
32-312-12	Opposite	Medium Bronze

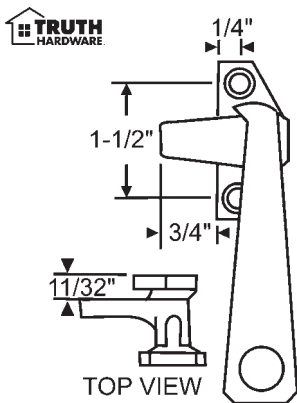

Part #	Hand	Finish
32-319-8	Shown	Chestnut Bronze
32-318-8	Opposite	Chestnut Bronze

Pole Hole

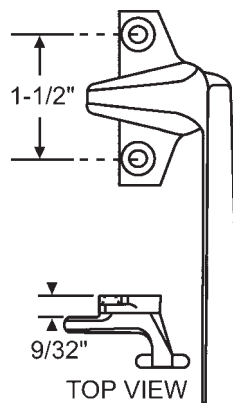

Part #	Hand	Finish
900-198LH	Shown	White Bronze
900-198RH	Opposite	White Bronze

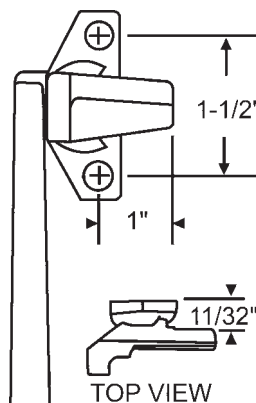

Part #	Finish
32-448-14	Cocoa Brown
32-448-3	White
32-448-9	Beige

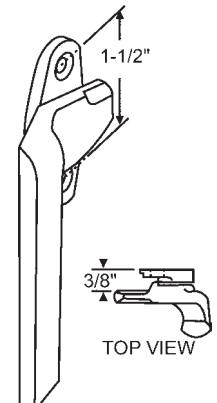

Part #	Finish
32-403	White
32-403BG	Beige

Use Keeper 50-836

Window Replacement Hardware

Two Hole Cam Handles

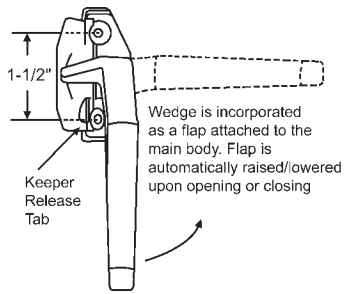

Part #	Hand	Finish
32-455RW	Shown	White
32-455LW	Opposite	White

Wedgeless Cam Handle

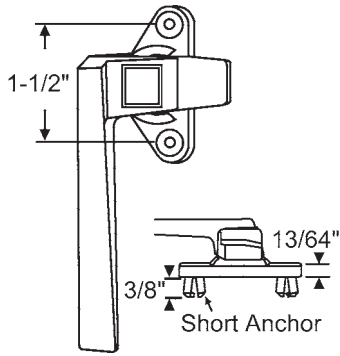

Part #	Hand	Finish
32-464LH	Shown	White
32-464RH	Opposite	White

Plastic

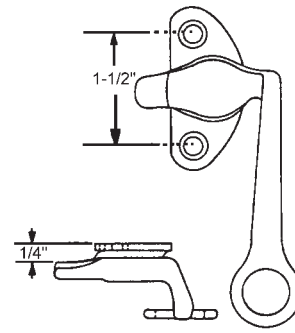

Part #	Finish
900-8988	Red Bronze

Pole Hole

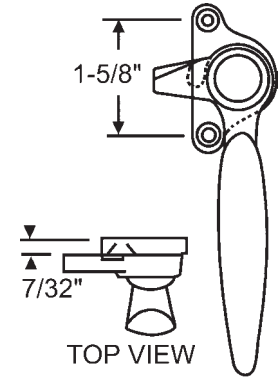

Part #	Finish
32-251	Copper

Water Rolled Finish
Project Out Handle

Three & Four Hole Cam Handles

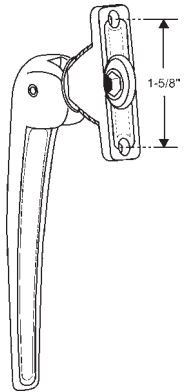

Part #	Finish
900-10729	White Bronze

Hex Handle, Plastic
Clearview

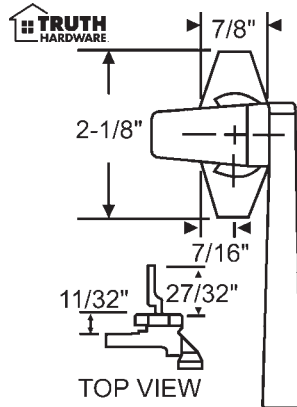

Part #	Hand	Finish
32-315-7	Shown	Aluminum
32-315-8	Shown	Chestnut Bronze
32-314-7	Opposite	Aluminum
32-314-8	Opposite	Chestnut Bronze

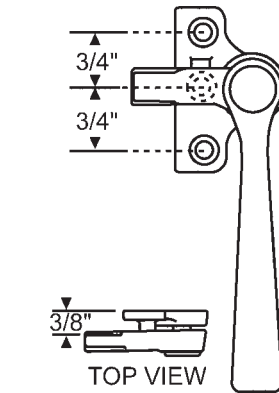

Part #	Hand	Finish
32-274	Shown	Light Bronze
32-275	Opposite	Light Bronze

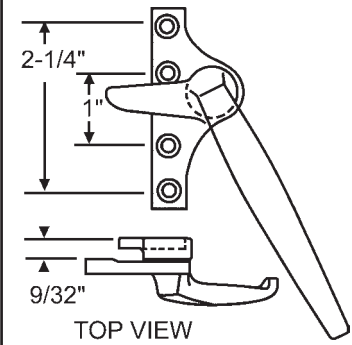

Part #	Hand	Finish
32-233	Shown	Red Bronze
32-234	Opposite	Red Bronze

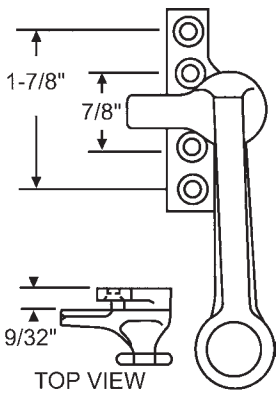

Part #	Finish
32-283	White Bronze

Pole Hole

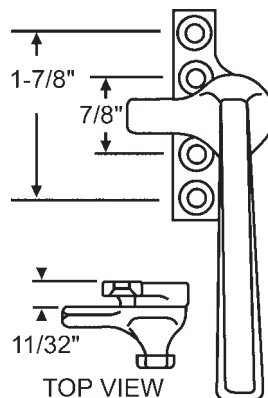

Part #	Hand	Finish
32-210	Shown	White Bronze
32-209	Opposite	White Bronze

Thorn

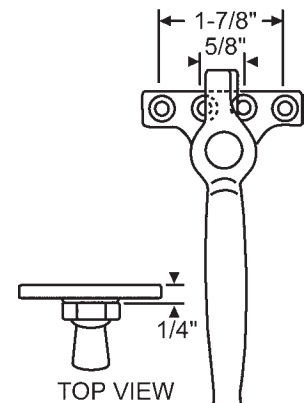

Part #	Finish
32-224	Dark Bronze

Use Screw 20-030

Window Replacement Hardware

Three & Four Hole Cam Handles

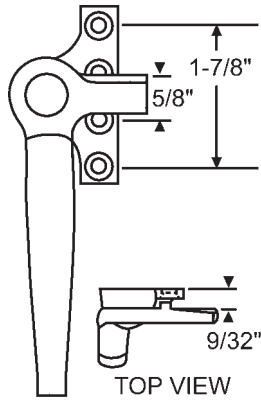

Part #	Hand	Finish
32-227	Shown	Dark Bronze
32-226	Opposite	Dark Bronze

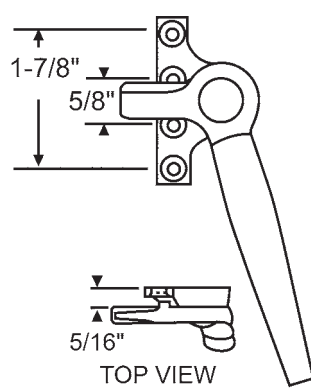

Part #	Hand	Finish
32-228DB	Shown	Dark Bronze
32-228	Shown	Red Bronze
32-229	Opposite	Red Bronze

Inside Glazed Handles

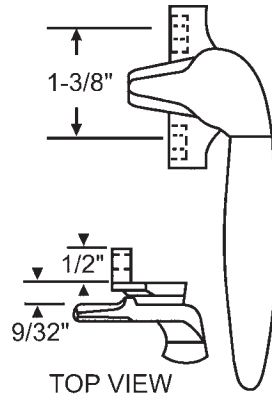

Part #	Hand	Finish
32-285	Shown	White Bronze
32-285LH	Opposite	White Bronze

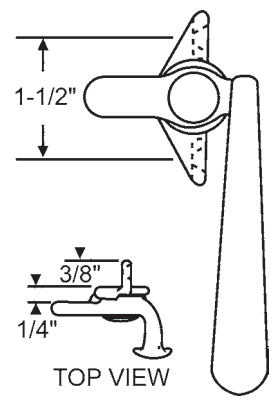

Part #	Finish
32-305	White Bronze

Project-In Handles

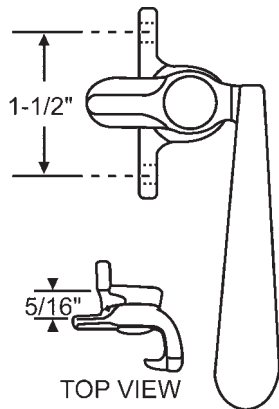

Part #	Finish
900-8601	White Bronze

Used with Keeper 50-726

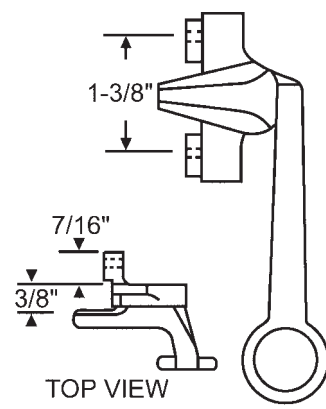

Part #	Finish
32-262	White Bronze

Holes Tapped 10-24

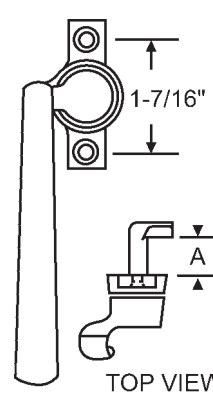

Part #	A	Finish
32-268	9/16"	White Bronze
32-268-5	1/2"	White Bronze

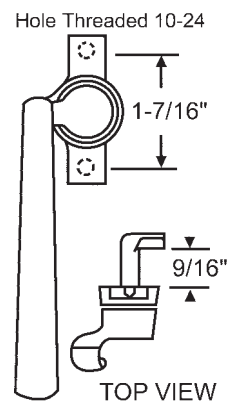

Part #	Hand	Finish
32-269LH	Shown	White Bronze
32-269RH	Opposite	White Bronze

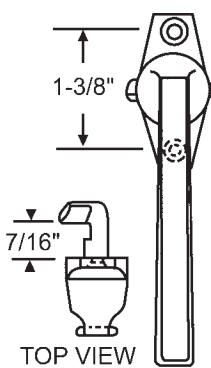

Part #	Finish
32-266	White Bronze

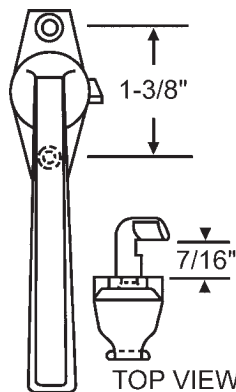

Part #	Finish
32-267	White Bronze

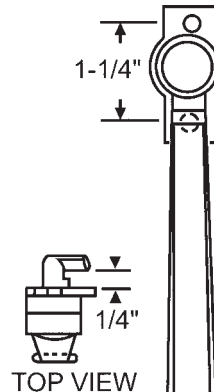

Part #	Finish
32-276	Copper

Water Rolled Finish

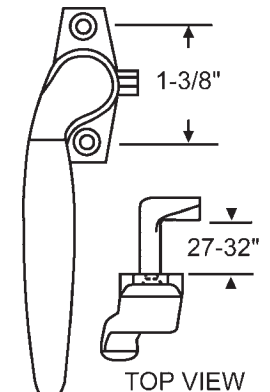

Part #	Finish
32-287	White Bronze

Window Replacement Hardware

Project-In Handles

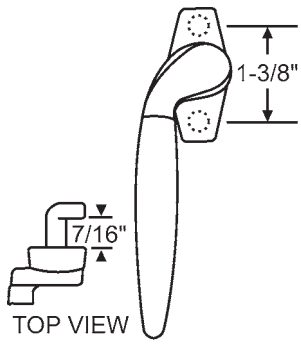

Part #	Finish
32-290	White Bronze

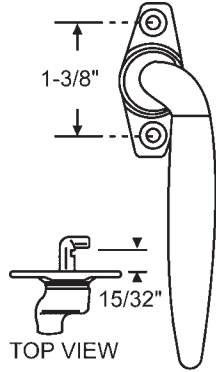

Part #	Hand	Finish
32-303	Shown	White Bronze
32-302	Opposite	White Bronze

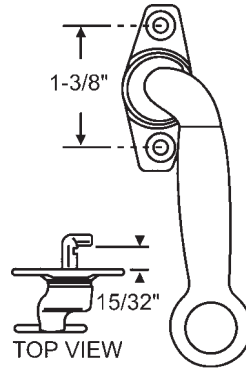

Part #	Hand	Finish
900-210RH	Shown	White Bronze
900-210LH	Opposite	White Bronze

Pole Ring

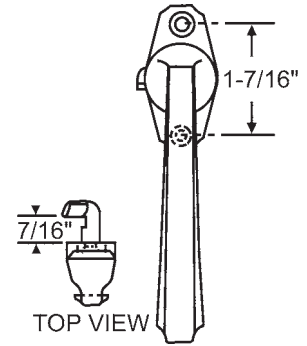

Part #	Hand	Finish
900-9799	Shown	Copper
900-9800	Opposite	Copper

Ware

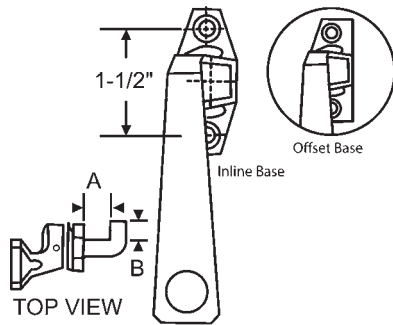

Part #	Finish	A	B	Base Type	Hand
32-341-8	Chestnut Bronze	7/16"	7/32"	Offset	Shown
32-342-8	Chestnut Bronze	7/16"	7/32"	Offset	Opposite
32-346-7	Aluminum	7/16"	7/32"	Inline	Opposite
32-347-8	Chestnut Bronze	1/2"	7/32"	Inline	Shown
32-348-8	Chestnut Bronze	1/2"	7/32"	Inline	Opposite

Pole Ring

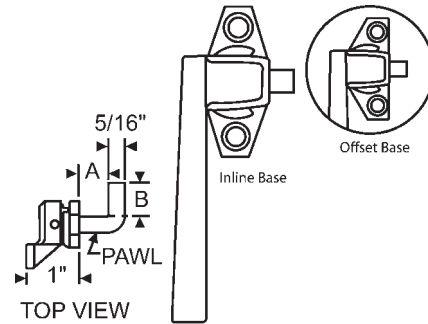

Part #	Finish	A	B	Base Type	Hand
32-329-8	Chestnut Bronze	7/16"	7/32"	Offset	Shown
32-330-8	Chestnut Bronze	7/16"	7/32"	Offset	Opposite
32-334-8	Chestnut Bronze	33/64"	11/32"	Offset	Opposite
32-335-8	Chestnut Bronze	7/16"	7/32"	Inline	Shown
32-336-7	Aluminum	7/16"	7/32"	Inline	Opposite
32-337-7	Aluminum	1/2"	7/32"	Inline	Shown
32-337-8	Chestnut Bronze	1/2"	7/32"	Inline	Shown
32-338-8	Chestnut Bronze	1/2"	7/32"	Inline	Opposite
32-339-8	Chestnut Bronze	33/64"	11/32"	Inline	Shown
32-351-3	White	7/8"	5/8"	Inline	Shown

Casement Handles

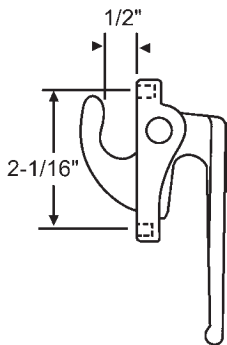

Part #	Finish
34-68	White Bronze

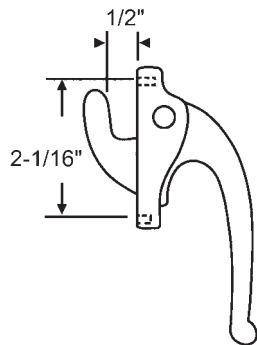

Part #	Finish
34-53	Dark Bronze

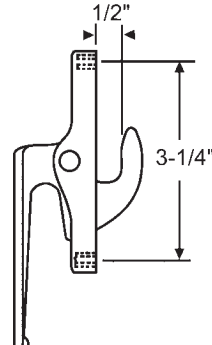

Part #	Finish
34-52	Dark Bronze

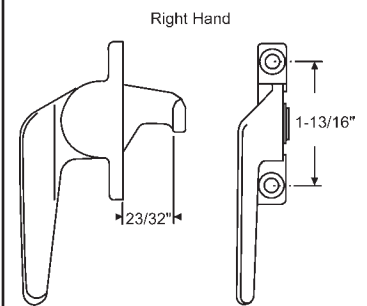

Part #	Hand	Finish
34-61	Shown	Light Bronze
34-62	Opposite	Light Bronze

Used with 50-717 Keeper

Window Replacement Hardware

Caseament Handles

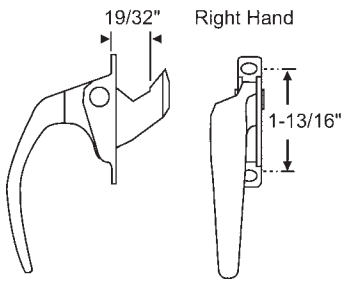

Part #	Hand	Finish
34-74	Shown	Bronze
34-75	Opposite	Bronze

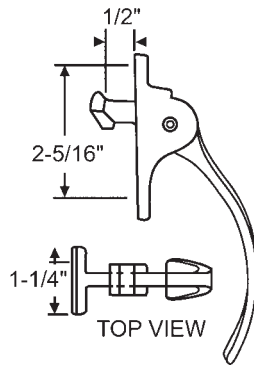

Part #	Finish
34-67DC	Light Bronze

Die Cast. Double Locking
Used with 50-717 Keeper

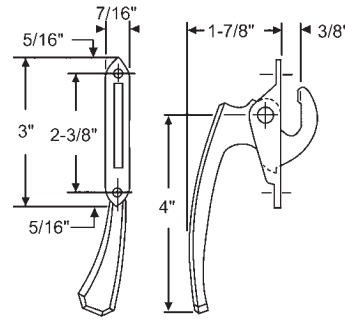

Part #	Hand	Finish
34-54	Shown	Bronze
34-55	Opposite	Bronze
34-54LB	Shown	Light Bronze
34-55LB	Opposite	Light Bronze

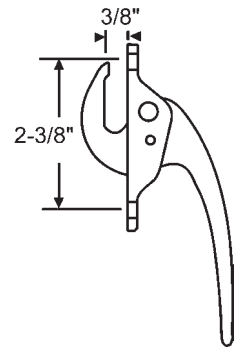

Part #	Finish
34-58W	White, Die Cast
34-58	Gray, Die Cast
34-69	Dark Bronze, Cast Brass

Curved Handle

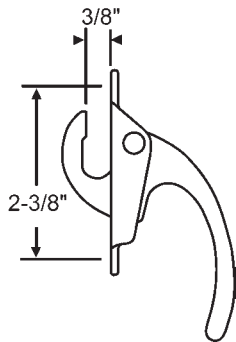

Part #	Finish
34-70	Brown
34-76	Dark Bronze

Die Cast

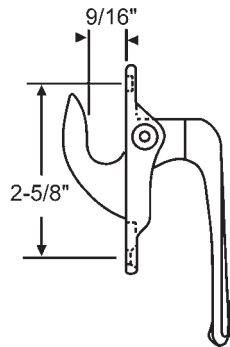

Part #	Hand	Finish
34-51	Shown	White Bronze
34-50	Opposite	White Bronze

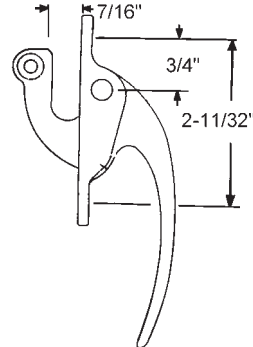

Part #	Finish
900-8977	White Bronze

Lower Casement Handle

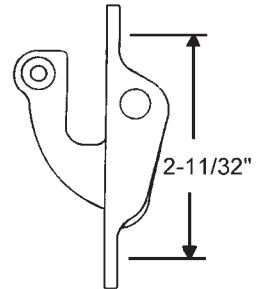

Part #	Finish
900-14118	White Bronze

Upper Locking Handle

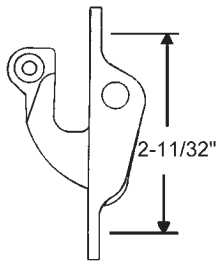

Part #	Finish
900-17428	White Bronze

Latch

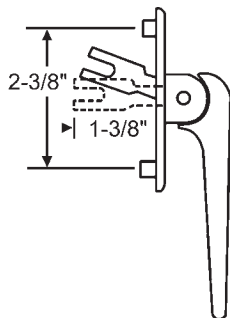

Part #	Finish
34-3	White

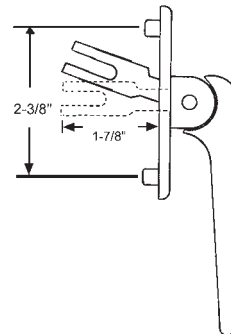

Part #	Finish
900-21135W	White

HOPPE
Handwerk seit 1874

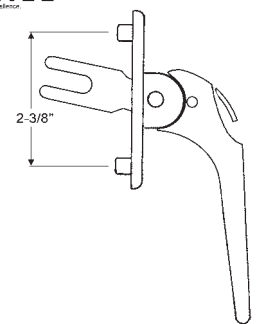

Part #	Finish
850-8782531	White

Window Replacement Hardware

Casement Handles

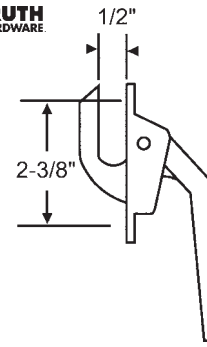
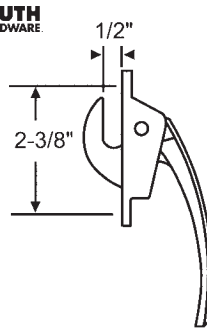
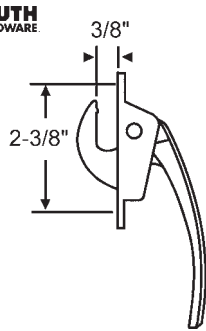
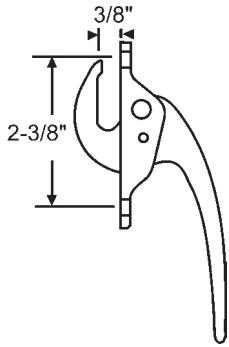

Part #	Finish
34-71	Light Bronze

Die Cast
Straight Handle

Part #	Finish
34-80-3	White
34-80-8	Chestnut Bronze
34-80-7	Aluminum
34-80-12	Medium Bronze

Part #	Finish
34-81-3	White
34-81-8	Chestnut Bronze

Part #	Finish
34-91-3	White

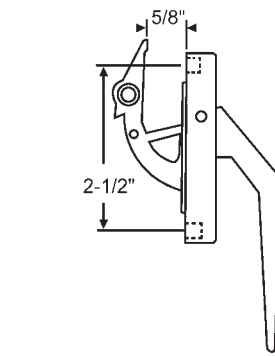
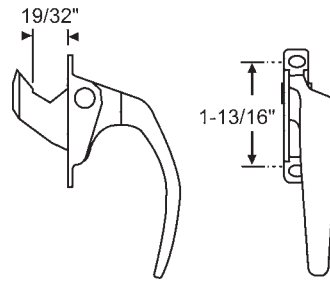
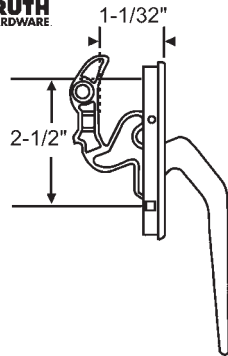
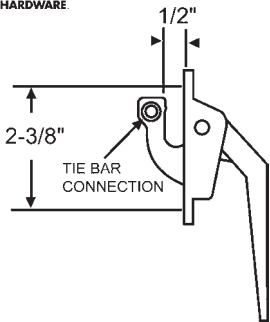

Part #	Finish
34-84-3	White
34-84-8	Chestnut Bronze
34-84-7	Aluminum
34-84-13	Brushed Copper Nickel

Dual Locking Handle

Part #	Finish
34-95-1	Bronze
34-95-3	White
34-95-8	Chestnut Bronze
34-95-9	Beige
34-95-7	Aluminum

Plastic Handle, Die Cast Lock Bar

Part #	Hand	Finish
34-75	Shown	Bronze
34-74	Opposite	Bronze

Hope

Part #	Finish
900-14723	Bronze

Acorn

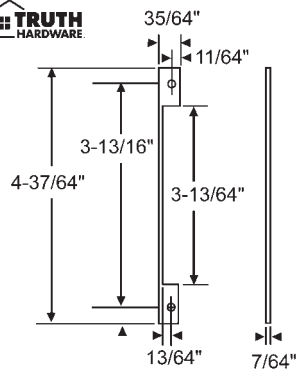
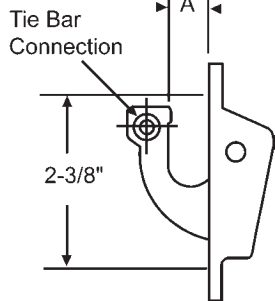

34-145
Mounting Plate

Part #	"A"	Finish
34-85-7	1/2"	Aluminum
34-85-8	1/2"	Chestnut Bronze
34-85-13	1/2"	Brushed Copper Nickel

Window Replacement Hardware

Caseament Handles

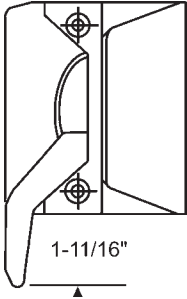

Part #	Hand	Finish
34-42-1	Shown	Bronze
34-43-1	Opposite	Bronze
34-42-3	Shown	White
34-43-3	Opposite	White
34-42-75	Shown	Coppertone
34-43-75	Opposite	Coppertone

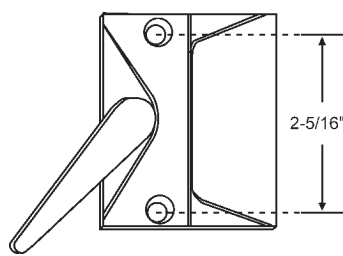

Part #	Finish
34-102-1	Bronze
34-102-3	White
34-102-5	Bright Brass

Non-Handed

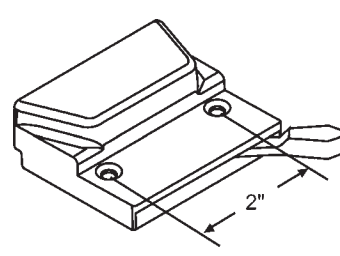

Part #	Finish
34-47-1	Bronze
34-47-2	Gold
34-47-3	White
34-47-9	Beige

Non-Handed

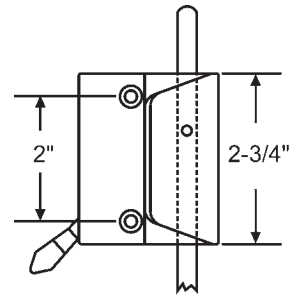

Part #	Finish
34-46-1	Bronze
34-46-3	White
34-49-29	Bright White

Non-Handed; for tandem application with use of tie bar (hole drilled through bottom gear piece).

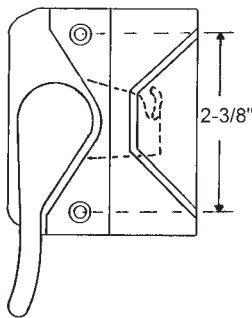

Part #	Hand	Finish
34-63-1	Shown	Bronze
34-64-1	Opposite	Bronze
34-63-2	Shown	Gold
34-64-2	Opposite	Gold
34-63-3	Shown	White
34-64-3	Opposite	White

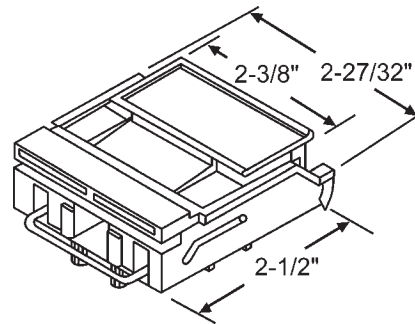

900-12199
Beige
Peachtree

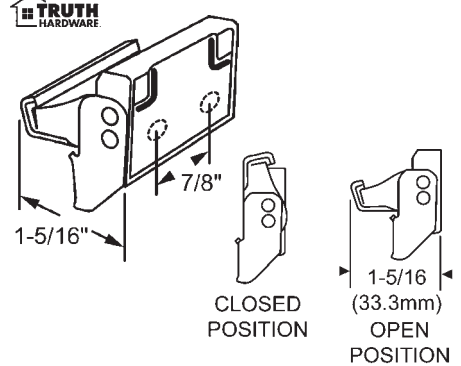

Part #	Finish
50-355-1	Bronze
50-355-2	Gold
50-355-3	White
50-355-10	Black

Check Rail Lock

Spring Catches

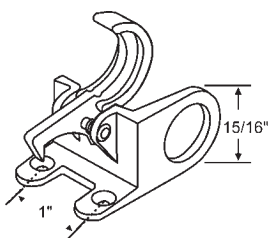

900-18718
Snap Lock with Pole Ring. White
Bronze. Use Screw 20-447

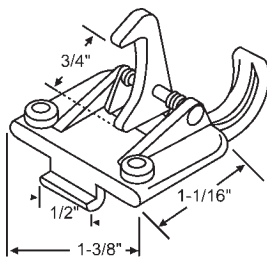

32-393
Lower Automatic Lock.
White Bronze
Seasonall

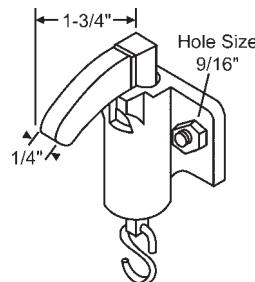

32-278

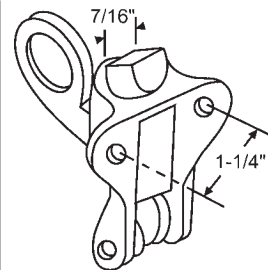

32-280

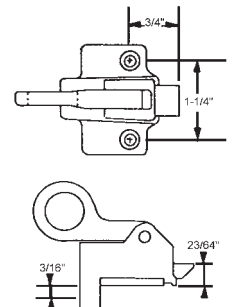

900-11332
White Bronze

Window Replacement Hardware

Removable Handle Keys



900-21413
Handle Cam Wrench
with 1/8" Hex



900-11209
Handle Cam Wrench
with 5/32" Hex

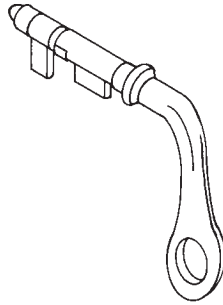

900-10521
Key for window. Many variations
can be made. Sample Required

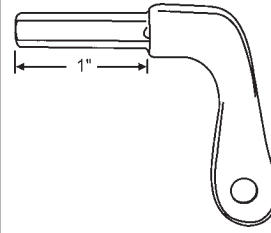

900-19637
1/4" Hex

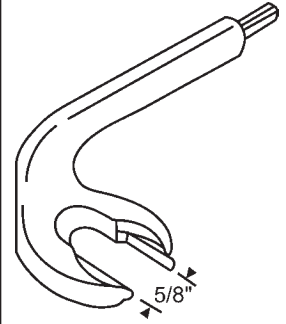

900-218
Hex fits 5/32" Allen Set Screw
for bronze handles.

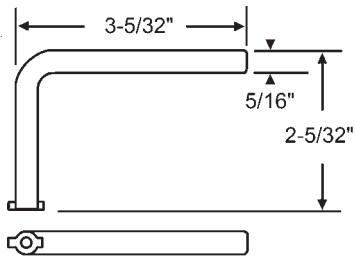

39-91
Custodial Lock Handle Key

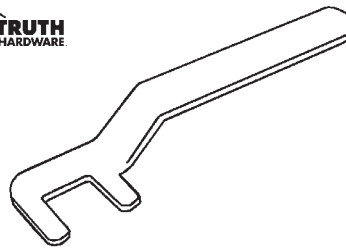

39-90
Spanner Tool for Truth Die Cast Locks

Project In, Project Out, & Casement Keepers

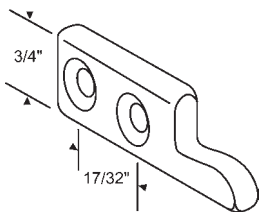

50-717
Brass

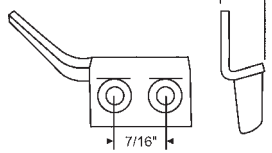

Part #	Hand
39-220	Shown
39-221	Opposite

Multipoint Lock Keeper

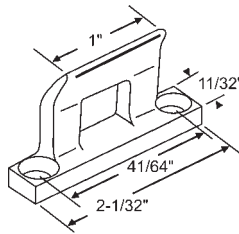

900-9107
Keeper for 32-277

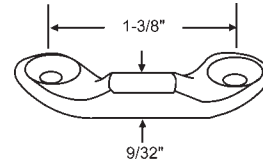

50-683
White Bronze

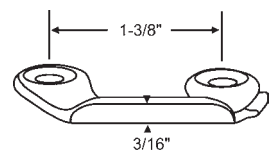

50-668
White Bronze

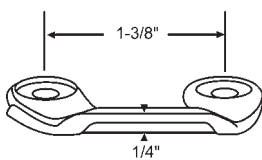

50-670
White Bronze
Used with Handle 32-284

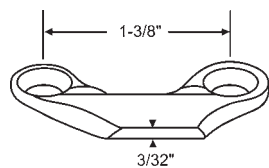

50-665
Projected Out Keeper
White Bronze

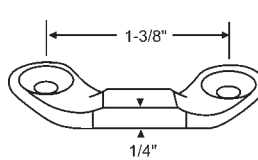

50-666
Dark Bronze

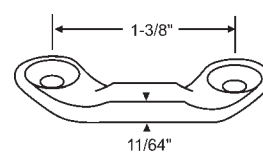

50-667
White Bronze

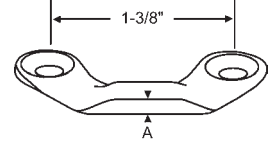

Part #	"A"
50-728	5/16"
50-674	3/16"

White Bronze

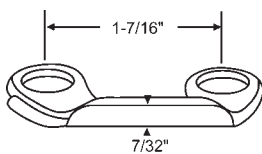

50-684
White Bronze

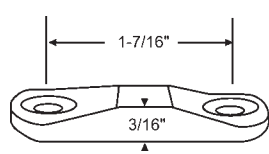

50-695
White Bronze

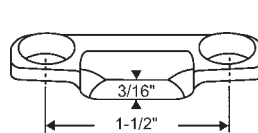

900-12905
White Bronze Burnished

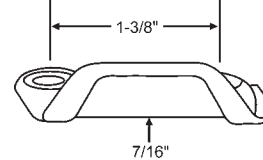

50-664
White Bronze

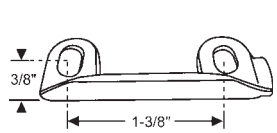

900-22584
White Bronze

Window Replacement Hardware

Project In, Project Out, & Casement Keepers

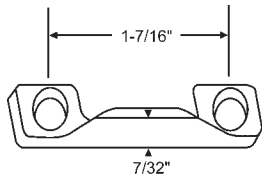

50-693
White Bronze

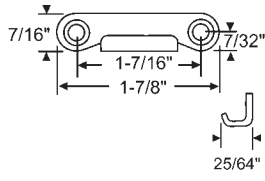

Part #	Finish
50-398-1	Bronze
50-398-2	Gold
50-398-3	White

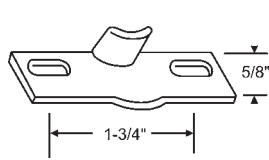

Part #	Finish
50-659	Aluminum

Dorchester

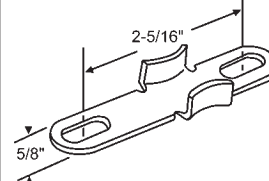

Part #	Finish
50-685A	Aluminum

Dorchester

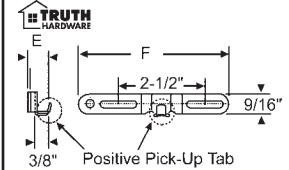

Part #	E	F
39-183	19/32"	4-19/32"
39-208	3/8"	4-47/64"

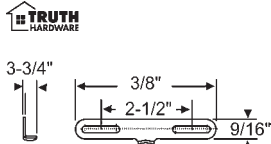

39-202
Stainless Steel

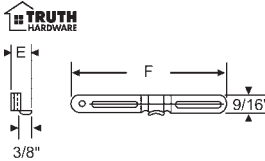

Part #	E	F
39-77	3/8"	4-47/64"
39-78	1/2"	4-41/64"
39-79	9/16"	4-19/32"

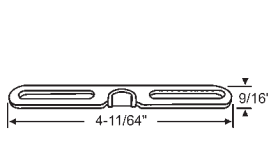

900-20912
Used with Cam Handle
900-14723W
Acorn

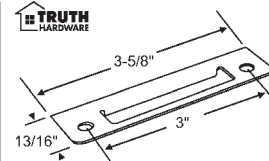

Part #	Finish
39-87-3	White
39-87-9	Beige

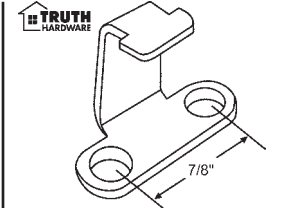

Part #	Finish
50-759	Stainless Steel

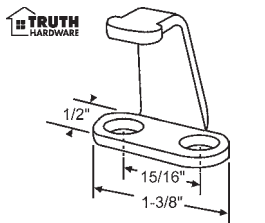

Part #	Finish
50-413	E-Gard Finish

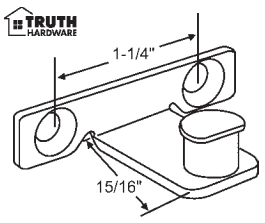

Part #	Finish
50-883	E-Gard Finish

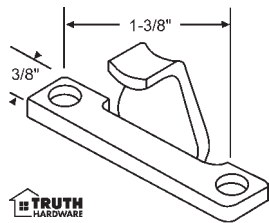

Part #	Finish
50-644	Steel

Use with 34-64, 34-63, 34-65, 34-66

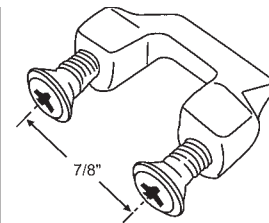

Part #	Finish
900-19680	White Bronze

Seasonall

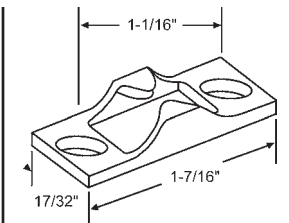

Part #	Finish
50-701	Die Cast

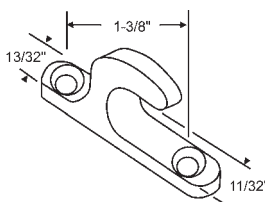

Part #	Finish
50-675	Dark Bronze

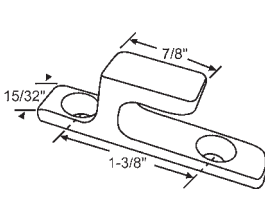

Part #	Finish
900-9761	White Bronze

Hook Type

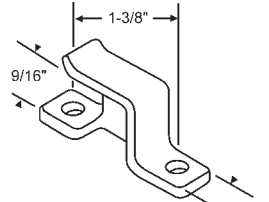

Part #	Finish
50-672	Dark Bronze

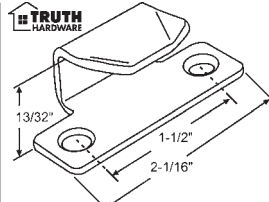

Part #	Finish
50-814-3	White
50-814-9	Beige

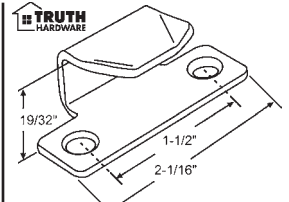

Part #	Finish
50-755-1	Bronze
50-755-3	White
50-755-14	Cocoa Brown

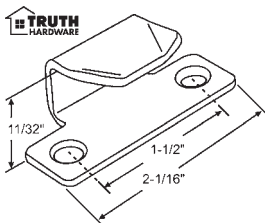

Part #	Finish
50-774-3	White
50-774-9	Beige

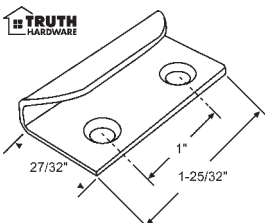

Part #	Finish
50-921	Beige

Zinc Die Cast

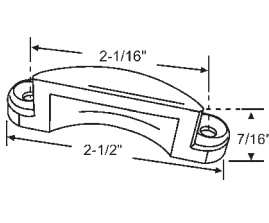

Part #	Finish
50-836OW	Off White

Plastic

Kasson/Keller

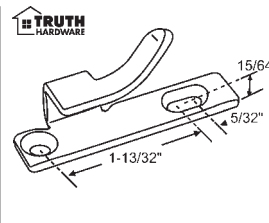

Part #	Hand	Finish
50-779	Shown	Champagne
50-780	Opposite	Champagne

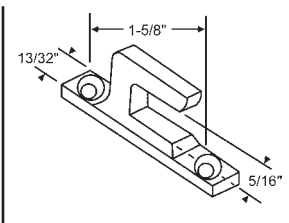

Part #	Finish
50-714	White

Hook Type. Used with 32-224,
32-228, 32-229 Handles

Window Replacement Hardware

Multi-Point Locks

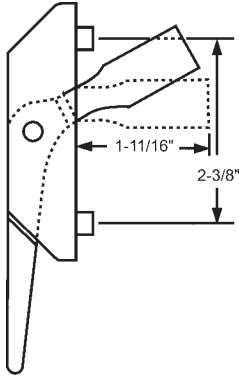

Part #	Finish
34-159	White

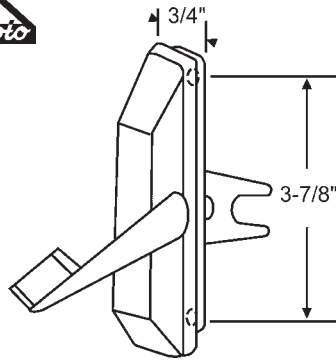

Part #	Finish
34-126BG	Beige
34-126EB	Earth Brown
34-126BEW	Blue White

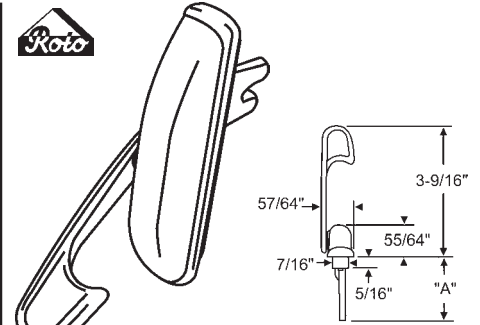

Part #	"A"	Finish
34-165-29W	1-9/64" (29mm)	White
34-165-29CY	1-9/64" (29mm)	Clay
34-165-37W	1-29/64" (37mm)	White



Part #	Hand	Finish
34-99-15NEG	Shown	Non E-Gard, Off White
34-99-1	Shown	Bronze
34-99-3	Shown	White
34-99-8	Shown	Chestnut Bronze
34-99-9	Shown	Beige
34-99-29	Shown	Bright White
34-100-1	Opposite	Bronze
34-100-3	Opposite	White
34-100-29	Opposite	Bright White
34-100-8	Opposite	Chestnut Bronze

Used in Tie Bar Applications

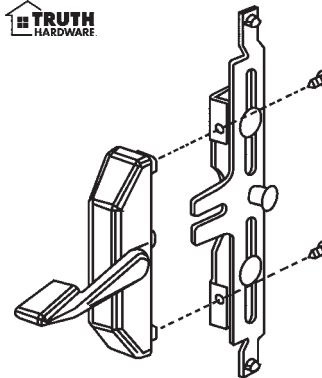
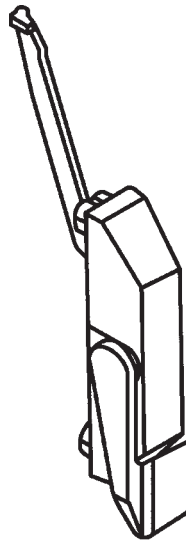

Part #	Hand	Finish
34-93-3	Shown	White
34-94-3	Opposite	White

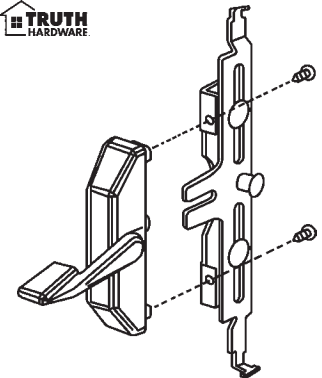

Part #	Hand	Finish
34-127-3	Shown	White
34-128-3	Opposite	White

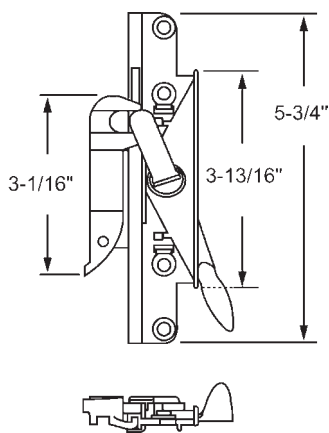

Part #	Hand	Finish
34-134-1	Shown	Bronze

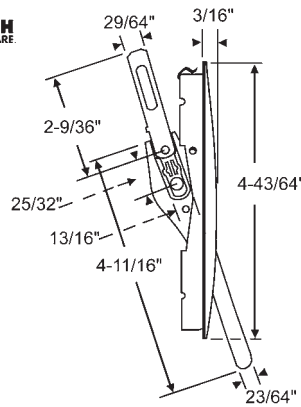

Part #	Hand	Finish
34-136-3	Shown	White
34-136-1	Shown	Bronze
34-136-4	Shown	Coppertone

Includes Locking Handle, Escutcheon and Backplate
Used with Keeper 50-883

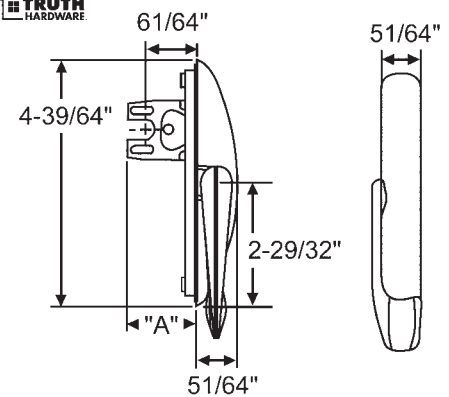

Part #	Finish	"A"
34-144-3G	White	1-41/64"
34-140-5G	Polished Brass	1-25/64"

Lock with Gasket